

1

2

3

4

5

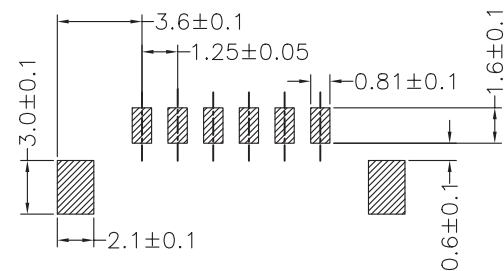

PCB LAYOUT - COMPONENT VIEW

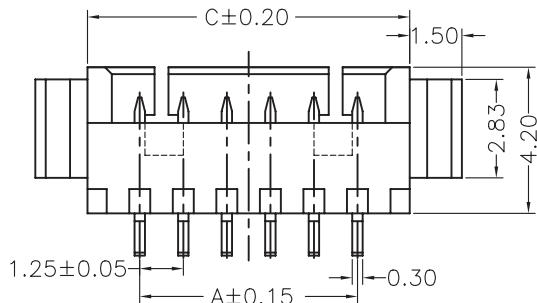
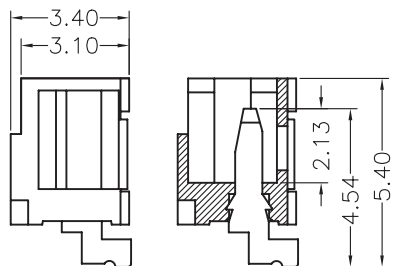
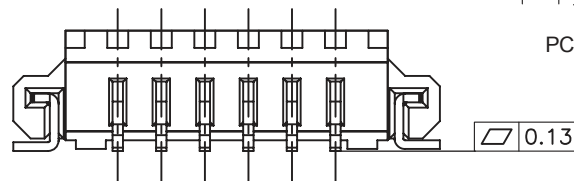

4~15P

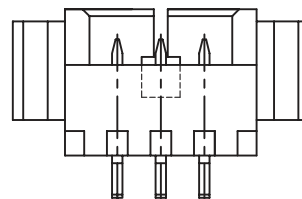

2P;3P

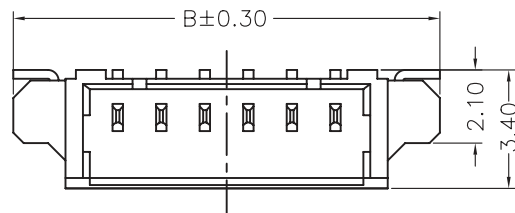

## TECHNICAL CHARACTERISTICS

## MATERIAL

INSULATOR: NYLON 46  
 FLAMMABILITY RATING: UL94-V0  
 COLOR: IVORY  
 CONTACT MATERIAL: COPPER ALLOY  
 CONTACT TYPE: STAMPED  
 CONTACT PLATING: TIN  
 QUALITY CLASS: 25 MATING CYCLES  
 PITCH: 1.25 MM

## ENVIRONMENTAL

OPERATING TEMPERATURE: -40 UP TO 85°C  
 COMPLIANCE: LEAD FREE AND ROHS

## ELECTRICAL

CURRENT RATING: 1 A  
 WORKING VOLTAGE: 125 VAC  
 INSULATOR RESISTANCE: >100 MOHM  
 DIELECTRIC WITHSTANDING VOLTAGE: 250 VAC/MN  
 CONTACT RESISTANCE: 20 mOHM MAX

## SOLDERING

JEDEC LEAD FREE REFLOW SOLDERING PROCESS

## PACKAGING

TAPE AND REEL

## DIMENSION

A = 1.25 x (NB PIN - 1)  
 B = 1.25 x (NB PIN + 1) + 3.5  
 C = 1.25 x (NB PIN + 1) + 0.5

RoHS Compliant

PROJECTION:

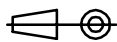

GENERAL TOLERANCE

.X = +/- 0.2

.XX = +/- 0.15



APPROVAL: BBu

UNIT: MM

DESCRIPTION: 1.25 MM SMT MALE HORIZONTAL SHROUDED HEADER

SIZE

I

14-SEP-16

TPK

AK

SCALE:

WERI PART NO: 653 1xx 131 822

A4

H

06-AUG-15

COLOR

AK

SHEET: 1/3

REV

DATE

FILE

BY

DRAW: ANDY

1

2

3

4

5



PRODUCT:XXPCS

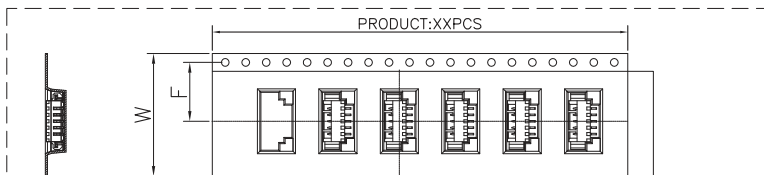

For Reel width (dimension W)16,24mm ,3 & 5PIN ONLY

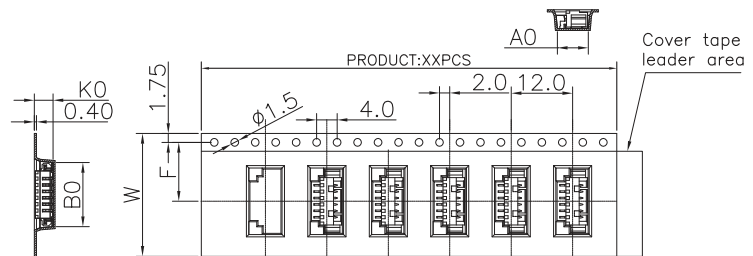

For Reel width (dimension W)16,24mm ,Single row hole

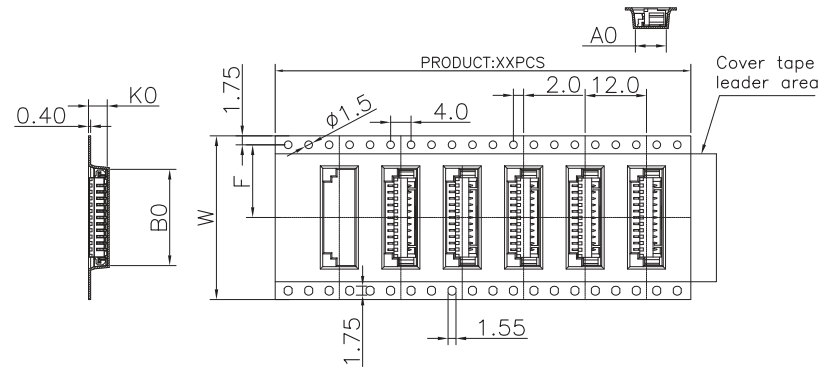

For Reel width (dimension W)32,44,56,72mm ,Double rows hole

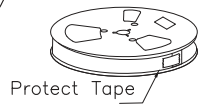
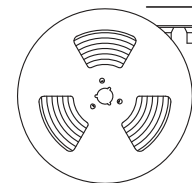
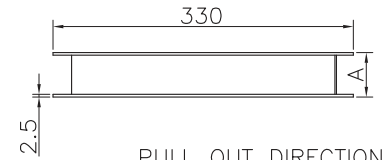

Vacuum Bag

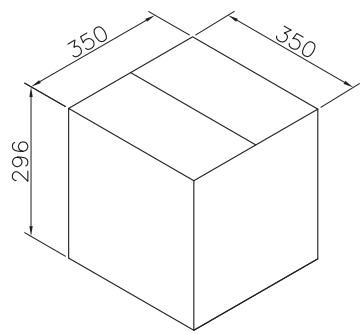
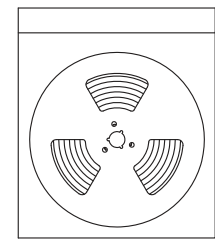

- Note:
- 1.All dimensions meet EIA-481-3 requirements.
  - 2.Material: Transparent Conductive Polystyrene Alloy 100% recyclable.
  - 3.Thickness: 0.40±0.05mm
  - 4.Component load per 13" reel:1500 pcs.
  - 5.CARTON SIZE:350\*350\*296(mm) Vacuum bag:450\*500\*0.2(mm)

Pin No	W	F	A0	B0	K0	PCS/R	R/CTN	Q'TY
02	24	11.5	6.05	7.55	3.65	1500	9	13500
03	24	11.5	6.05	8.80	3.65	1500	9	13500
04	24	11.5	6.05	10.05	3.65	1500	9	13500
05	24	11.5	6.05	11.30	3.65	1500	9	13500
06	24	11.5	6.05	12.55	3.65	1500	9	13500
07	24	11.5	6.05	13.80	3.65	1500	9	13500
08	24	11.5	6.05	15.05	3.65	1500	9	13500
09	24	11.5	6.05	16.30	3.65	1500	9	13500
10	32	14.2	6.05	17.55	3.65	1500	7	10500
11	32	14.2	6.05	18.80	3.65	1500	7	10500
12	44	14.2	6.05	20.05	3.65	1500	5	7500
13	44	14.2	6.05	21.30	3.65	1500	5	7500
14	44	20.2	6.05	22.55	3.65	1500	5	7500
15	44	20.2	6.05	23.80	3.65	1500	5	7500

RoHS Compliant			
G			
F			
E			
D			
C			
B			
A			
REV	DATE	FILE	BY

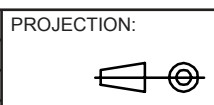

APPROVAL: BBu

GENERAL TOLERANCE  
 .X = +/- 0.2  
 .XX = +/- 0.15



UNIT: MM  
 SCALE:  
 SHEET: 2/3  
 DRAW: PEARL

DESCRIPTION: 1.25 MM SMT MALE HORIZONTAL SHROUDED HEADER  
 WERI PART NO: 653 1xx 131 822

SIZE  
**A4**

A

B

C

D

1

2

3

4

5

## Cautions and Warnings:

This electronic component is designed and developed with the intention for use in general electronics equipments.



Before incorporating the components into any equipments in the field such as aerospace, aviation, nuclear control, submarine, transportation, (automotive control, train control, ship control), transportation signal, disaster prevention, medical, public information network etc. where higher safety and reliability are especially required or if there is possibility of direct damage or injury to human body, Würth Elektronik must be asked for a written approval.

In addition, even electronic component in general electronic equipments, when used in electrical circuits that require high safety, reliability functions or performance, the sufficient reliability evaluation-check for the safety must be performed before by the user before usage.

A

B

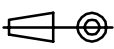
C

RoHS Compliant				PROJECTION: 	GENERAL TOLERANCE .X = +/- 0.2 .XX = +/- 0.15		DESCRIPTION: DISCLAIMER	SIZE <b>A4</b>
G								
F								
E								
D								
C				APPROVAL: JC	UNIT: MM	WERI PART NO: DISCLAIMER	SIZE <b>A4</b>	
B				SCALE:				
A	10-SEP-14	PDF	QL	SHEET: 3/3				
REV	DATE	FILE	BY	DRAW: QL				

D