

### Features

- ◆ Non-Magnetic Package Suitable for MRI Applications
- ◆ Rectangular MELF SMQ Ceramic Package
- ◆ Hermetically Sealed
- ◆ Low  $R_s$  for Low Series Loss
- ◆ Long  $\tau_L$  for Lower Intermodulation Distortion
- ◆ Low  $C_j$  for High Series Isolation
- ◆ High Average Incident Power Handling
- ◆ RoHS Compliant

### Description

The MA4P7446F-1091T is a surface mountable PIN diode in a non-magnetic, **Metal Electrode Leadless Faced (MELF)** package. The device incorporates M/A-COM Technology Solutions time proven HIPAX technology to produce a low inductance ceramic package with no ribbons or whisker wires. Incorporated in the package is a hard glass passivated, CERMACHIP™ PIN chip that is full face bonded on both the cathode and anode to maximize surface area for the lowest electrical and thermal resistance. The package utilizes a non-magnetic plating process that provides for a package with extremely low permeability. The MA4P7446F-1091T has been comprehensively characterized both electrically and mechanically to ensure repeatable and predictable performance. The non-magnetic MA4P7446F-1091T is the electrical equivalent of its magnetic counterpart the MA4P4006F-1091T.

### Applications

This diode is well suited for use in low loss, low distortion, high power switching circuits and can be used in high magnetic field environments at HF through UHF frequencies. The low thermal resistance of this device provides excellent performance at high RF power incident levels, up to 500 watts CW. This device is designed to meet the most demanding electrical and mechanical MRI environments.

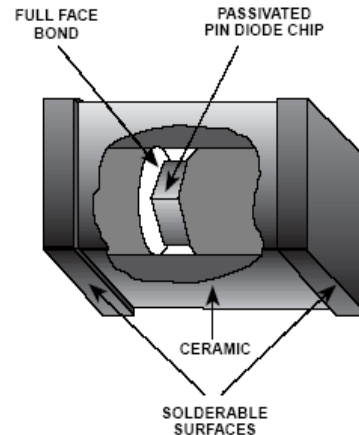

### Designed for Automated Assembly

These SMQ PIN diodes are designed for high volume tape and reel assembly. The rectangular package design provides for highly efficient automatic pick and place assembly techniques. The parallel flat surfaces are suitable for key jaw or vacuum pickup. All solderable surfaces are tin plated and compatible with industry standard reflow and vapor phase soldering methods.

### Absolute Maximum Ratings<sup>1</sup> @ 25°C

Parameter	Absolute Maximum
Operating Temperature	-65°C to +125°C
Storage Temperature	-65°C to +150°C
Diode Junction Temperature	+175 °C Continuous
Diode Mounting Temperature	+235°C for 10 seconds
RF C.W. Incident Power	+ 57dBm C.W.
Forward D.C. Current	+500 mA
Reverse D.C. Voltage @ -10 uA	- 600V

1. Exceeding these limits may cause permanent damage.

### Electrical Specifications @ T<sub>AMBIENT</sub> = +25°C

Parameter	Symbol	Condition	Unit Value
Forward Voltage	V <sub>F</sub>	I <sub>F</sub> = +100mA	1.0 V <sub>DC</sub> (Max.)
Reverse Voltage	V <sub>R</sub>	I <sub>R</sub> = -1μA	600V <sub>DC</sub> (Min.)
Total Capacitance	C <sub>T</sub>	-100V @ 1MHz	2.2pF (Max.)
Series Resistance	R <sub>S</sub>	+100mA @ 100MHz	0.5Ω (Max)
Parallel Resistance	R <sub>P</sub>	-10V @ 100MHz	□10KΩ (Min.)
Carrier Lifetime	t <sub>L</sub>	I <sub>F</sub> = +6mA , I <sub>R</sub> = -10mA (50% - 90% Voltage)	19μs (Typ.)
I-Region Length	μM	—	175μM (Typ.)
C.W. Thermal Resistance	θ	I <sub>HIGH</sub> = 1A, I <sub>LOW</sub> = 10mA, T = 1mS	6°C/W (Max.)
Power Dissipation in Free Air	W	I <sub>F</sub> = +100mA	8W (Max.)
Power Dissipation	P <sub>DISS</sub>	I <sub>F</sub> = +100mA	25W (Max.)

### Environmental Capability

MELF devices are appropriate for use in industrial and military applications and can be screened to meet the environmental requirements of MIL-STD-750, MIL-STD-202 as well as other military standards. The table below lists some of the MIL-STD 750 tests the device is designed to meet.

MIL-STD-750		
Test	Method	Description
High Temperature Storage	1031	+150°C, for 340 Hours
Temperature Shock	1051	-65°C to +150°C, 20 Cycles
HTRB	1038	80% of rated V <sub>B</sub> , +150°C, for 96 Hours
Moisture Resistance	1021	No Initial Conditioning, 85% RH, +85°C
Gross Leak	1071 Cond. E	Dye Penetrant Visual
Vibration Fatigue	2046	20,000G's, 60Hz, x, y, z axis
Solderability	2026	Test Temperature = +245°C

### Typical Electrical Performance @ +25°C

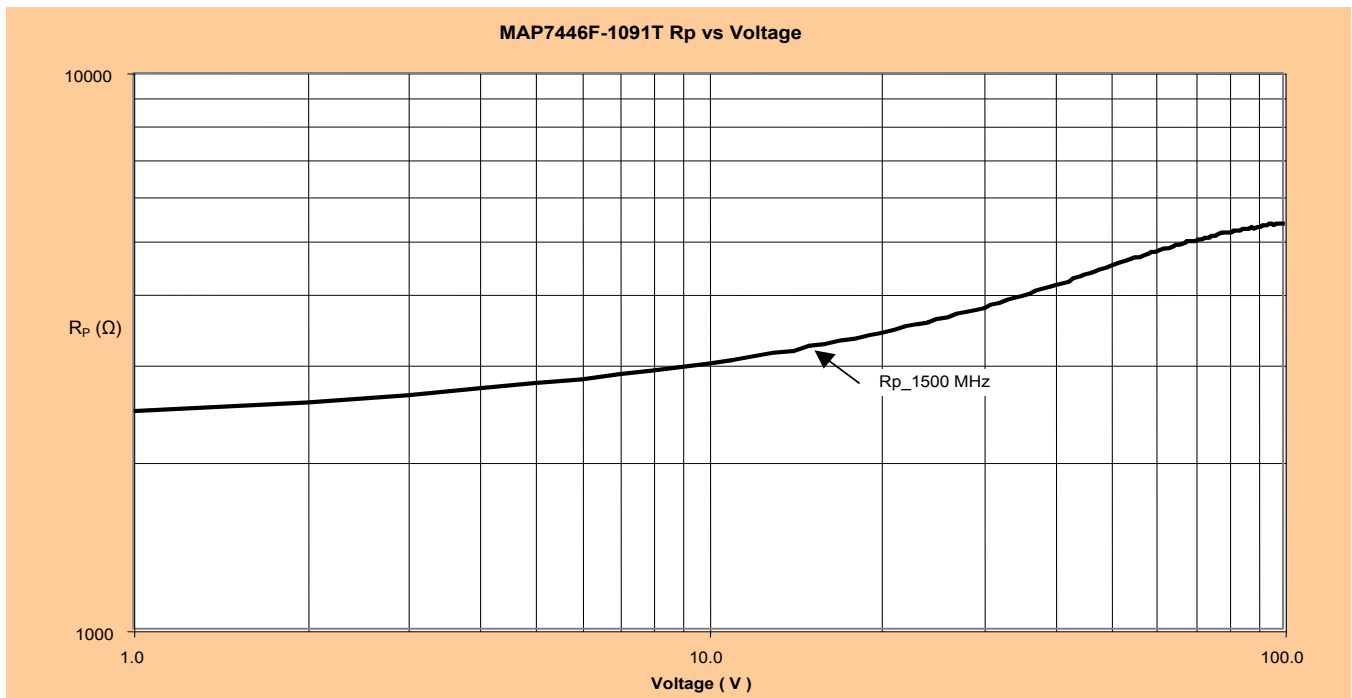
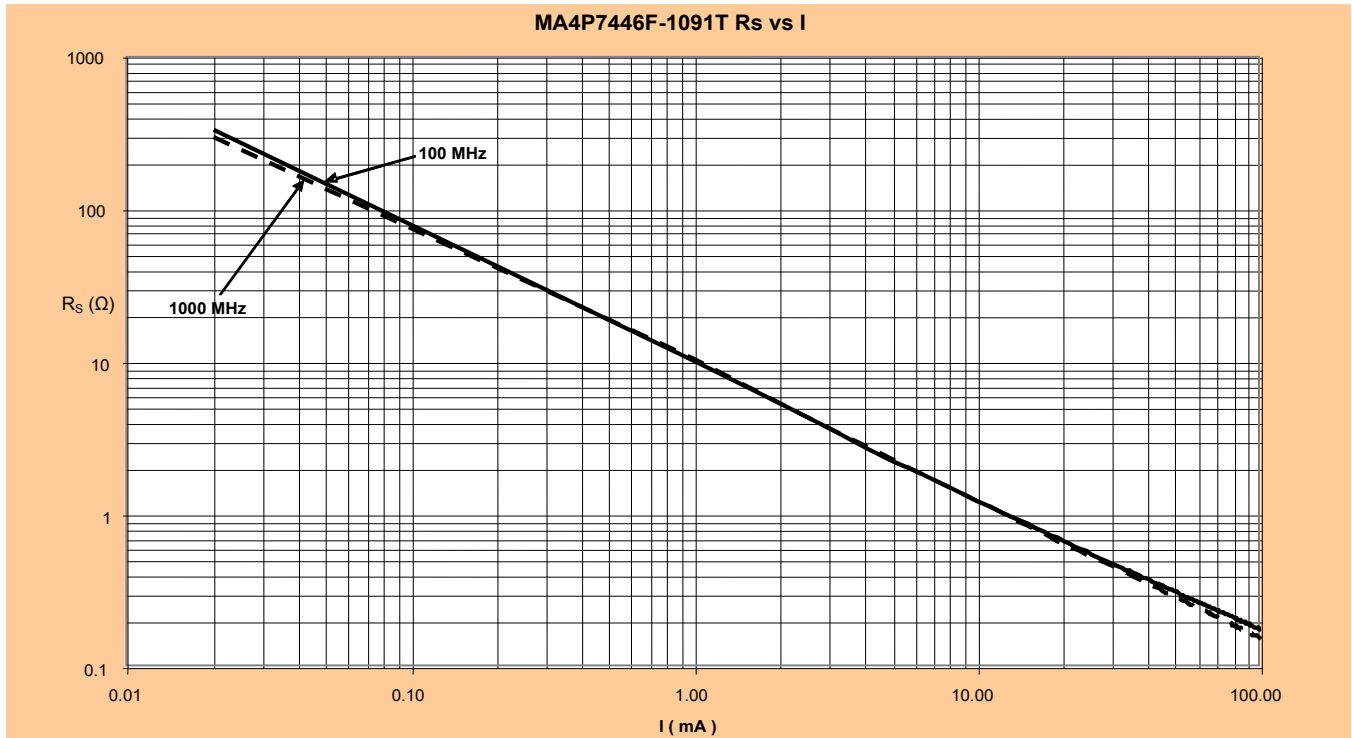

### Typical Electrical Performance @ +25°C

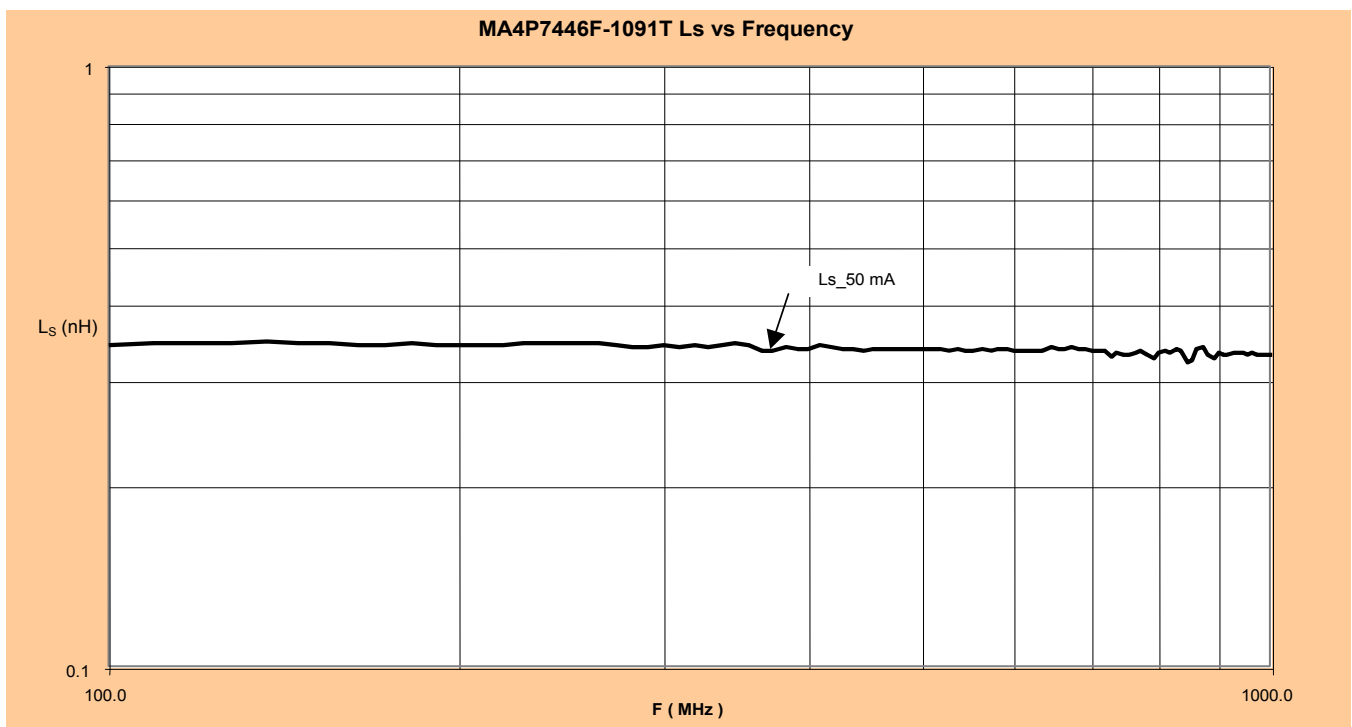
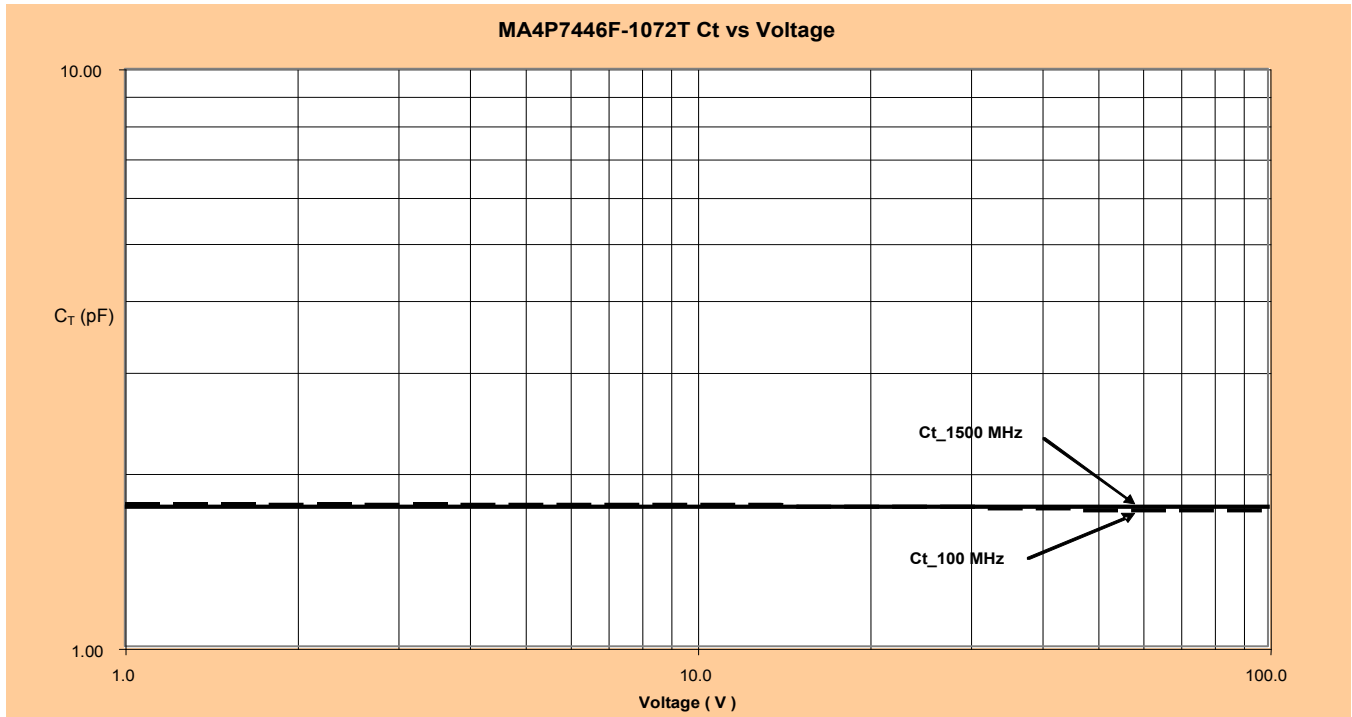

4  
4

## Typical Magnetic vs. Non-Magnetic Performance

### Magnetic Moment for MA4P7400F-1091T Non-Magnetic Series vs. MA4P4000F-1091T Series

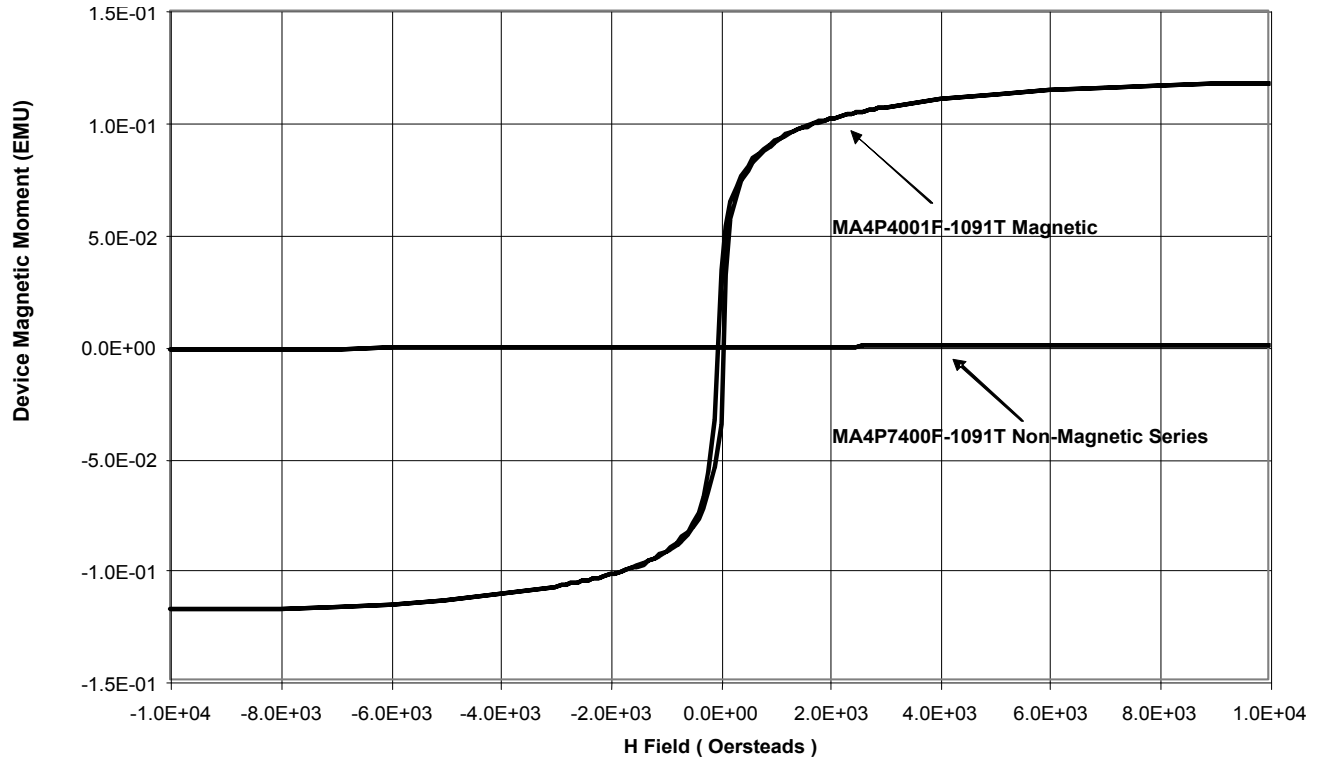

### Typical Magnetic Properties of Non-Magnetic MA4P7400F-1091T Series

#### vs. Conventional MA4P4000F-1091T Magnetic Series

Magnetic Property	MA4P7400F-1091T Series Value	MA4P4000-1091T Series Value
Saturation Moment (EMU) @ H = H <sub>MAX</sub> Oersteds	1.0 x E-3	1.2 x E-1
Remanance Moment (EMU) @ H = 0 Oersteds	1.5 x E-6	3.4 x E-2
Coercivity (Oersteds) @ EMU = 0 Moment	3.0	51.3

5  
5

M/A-COM Technology Solutions Inc. (MACOM) and its affiliates reserve the right to make changes to the product(s) or information contained herein without notice. Visit [www.macom.com](http://www.macom.com) for additional data sheets and product information.

For further information and support please visit:  
<https://www.macom.com/support>

## Mechanical Information

### 1091 MELF Surface Mount Package

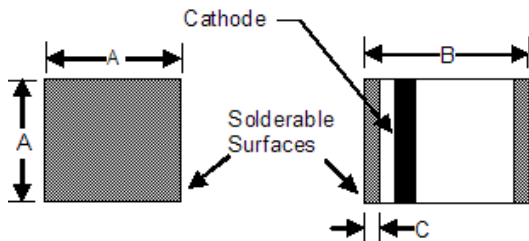

### Circuit Pad Layout for MELF Diodes

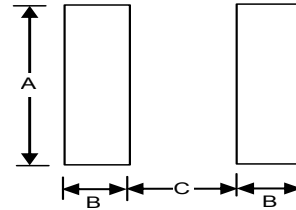

Case Style	Dimensions in Inches (mm)		
	A Square Min / Max	B Min / Max	C Min / Max
1091	0.138 / 0.155 (3.50 / 3.94)	0.180 / 0.200 (4.57 / 5.08)	0.008 / 0.030 (.203 / .762)

Dimension	Package Style 1091	
	inches	mm
A	0.150	3.81
B	0.050	1.27
C	0.100	2.54

## MELF Assembly Recommendations

- ◆ Devices may be soldered using standard 60Sn/40Pb or RoHS compliant solders. Axial leads and solderable surfaces of MELF devices are tin plated 50  $\mu$ m thick to ensure an optimum connection.
- ◆ For recommended Sn/Pb and RoHS soldering profiles See Application Note [M538](#) on the M/A-COM website.

## Ordering Information

Part Number	Package	Quantity
MA4P7446F-1091T	Tape and Reel	500pcs/Reel

M/A-COM Technology Solutions Inc. All rights reserved.

Information in this document is provided in connection with M/A-COM Technology Solutions Inc ("MACOM") products. These materials are provided by MACOM as a service to its customers and may be used for informational purposes only. Except as provided in MACOM's Terms and Conditions of Sale for such products or in any separate agreement related to this document, MACOM assumes no liability whatsoever. MACOM assumes no responsibility for errors or omissions in these materials. MACOM may make changes to specifications and product descriptions at any time, without notice. MACOM makes no commitment to update the information and shall have no responsibility whatsoever for conflicts or incompatibilities arising from future changes to its specifications and product descriptions. No license, express or implied, by estoppel or otherwise, to any intellectual property rights is granted by this document.

THESE MATERIALS ARE PROVIDED "AS IS" WITHOUT WARRANTY OF ANY KIND, EITHER EXPRESS OR IMPLIED, RELATING TO SALE AND/OR USE OF MACOM PRODUCTS INCLUDING LIABILITY OR WARRANTIES RELATING TO FITNESS FOR A PARTICULAR PURPOSE, CONSEQUENTIAL OR INCIDENTAL DAMAGES, MERCHANTABILITY, OR INFRINGEMENT OF ANY PATENT, COPYRIGHT OR OTHER INTELLECTUAL PROPERTY RIGHT. MACOM FURTHER DOES NOT WARRANT THE ACCURACY OR COMPLETENESS OF THE INFORMATION, TEXT, GRAPHICS OR OTHER ITEMS CONTAINED WITHIN THESE MATERIALS. MACOM SHALL NOT BE LIABLE FOR ANY SPECIAL, INDIRECT, INCIDENTAL, OR CONSEQUENTIAL DAMAGES, INCLUDING WITHOUT LIMITATION, LOST REVENUES OR LOST PROFITS, WHICH MAY RESULT FROM THE USE OF THESE MATERIALS.

MACOM products are not intended for use in medical, lifesaving or life sustaining applications. MACOM customers using or selling MACOM products for use in such applications do so at their own risk and agree to fully indemnify MACOM for any damages resulting from such improper use or sale.

7  
7

---

M/A-COM Technology Solutions Inc. (MACOM) and its affiliates reserve the right to make changes to the product(s) or information contained herein without notice. Visit [www.macom.com](http://www.macom.com) for additional data sheets and product information.