

ORDERING INFORMATION

Device	Temperature Range	Package
MC1430F,1431F	0°C to +70°C	Ceramic Flat
MC1430G,1431G	0°C to +70°C	Metal Can
MC1430P,1431P	0°C to +70°C	Plastic DIP
MC1530F,1531F	-55°C to +125°C	Ceramic Flat
MC1530G,1531G	-55°C to +125°C	Metal Can

OPERATIONAL AMPLIFIER

... designed for use as a summing amplifier, integrator, or amplifier with operating characteristics as a function of the external feedback components.

The MC1531 (MC1431) is provided with Darlington inputs to increase input impedance; otherwise the MC1531 (MC1431) circuit is identical with the MC1530 (MC1430) circuit.

- High Open Loop Voltage Gain – 4500 min (MC1530)
– 2500 min (MC1531)
- High Input Impedance – 10 Kiloohms min (MC1530)
– 1.0 Megohm min (MC1531)
- Low Output Impedance – 50 Ohms max
- High Slew Rate – 6.0 V/ μ s typ @ $A_{VS} = 10$
- High Open Loop Bandwidth – 2.0 MHz typ (MC1530)
0.4 MHz typ (MC1531)

MAXIMUM RATINGS ($T_A = 25^\circ\text{C}$ unless otherwise noted)

Rating	Symbol	Value	Unit	
Power Supply Voltage MC1530, MC1531 MC1430, MC1431	V_{CC}, V_{EE}	+9.0, -9.0	Vdc	
	V_{CC}, V_{EE}	+8.0, -8.0		
Differential Input Voltage Range	V_{IDR}	± 5.0	Volts	
Load Current	I_L	10	mA	
Power Dissipation (Package Limitation)	P_D	680	mW	
		Derate above $T_A = +25^\circ\text{C}$	4.6	mW/ $^\circ\text{C}$
		Flat Package	500	mW
		Derate above $T_A = +25^\circ\text{C}$	3.3	mW/ $^\circ\text{C}$
		Dual In-Line Plastic Package MC1430, MC1431	400	mW
Derate above $+25^\circ\text{C}$	3.3	mW/ $^\circ\text{C}$		
Operating Ambient Temperature Range MC1530, MC1531 MC1430, MC1431	T_A	-55 to +125	$^\circ\text{C}$	
		0 to +75		
Storage Temperature Range Metal and Ceramic Package Plastic Package	T_{stg}	-65 to +175	$^\circ\text{C}$	
		-55 to +150		

CIRCUIT SCHEMATICS

FIGURE 1 – MC1530/MC1430
(STANDARD INPUT)

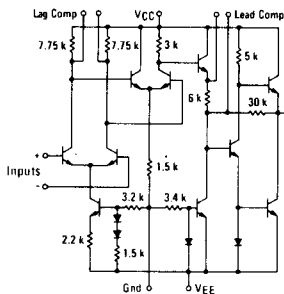
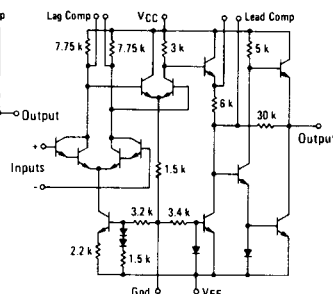

FIGURE 2 – MC1531/MC1431
(DARLINGTON INPUT)



MC1430, MC1431 MC1530, MC1531

OPERATIONAL AMPLIFIERS

SILICON MONOLITHIC INTEGRATED CIRCUIT

PIN CONNECTIONS

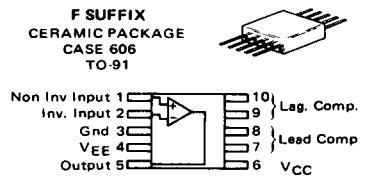

**G SUFFIX
METAL PACKAGE
CASE 603 B**

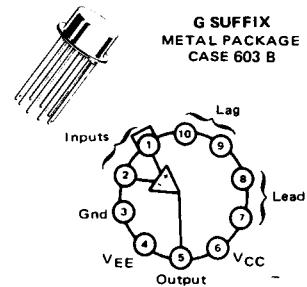

**P SUFFIX
PLASTIC PACKAGE
CASE 646
(MC1430P/MC1431P only)**

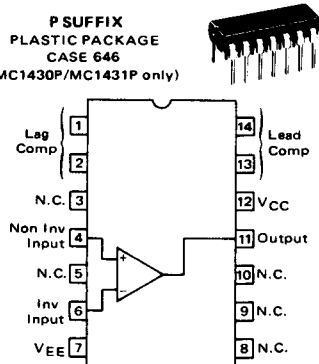

MC1430, MC1431, MC1530, MC1531

ELECTRICAL CHARACTERISTICS ($V_{CC} = +6.0$ Vdc, $V_{EE} = -6.0$ Vdc, $T_A = +25^\circ\text{C}$ unless otherwise noted)

Characteristic	Symbol	MC1530			MC1430			Unit	
		Min	Typ	Max	Min	Typ	Max		
Input Bias Current	I_{IB}	—	3.0	10	—	5.0	15	μAdc	
Input Offset Current	I_{IO}	—	0.2	2.0	—	0.4	4.0	μAdc	
Input Offset Voltage	V_{IO}	$T_A = +25^\circ\text{C}$	—	1.0	5.0	—	2.0	10	mVdc
		$T_A = T_{low}$ ①	—	—	6.0	—	—	11	
		$T_A = T_{high}$ ①	—	—	6.0	—	—	12	
Single-Ended Input Impedance (Open-Loop, $f = 30$ Hz)	z_{is}	10	20	—	5.0	15	—	k Ω	
Common-Mode Input Voltage Swing	V_{ICR}	± 2.0	± 2.7	—	± 2.0	± 2.5	—	V _{pk}	
Equivalent Input Noise Voltage (Open-Loop, $R_s = 50$ ohms, BW = 5.0 MHz)	e_N	—	10	—	—	10	—	$\mu\text{V(rms)}$	
Common-Mode Rejection Ratio ($f = 100$ Hz)	CMRR	70	75	—	65	75	—	dB	
Open-Loop Voltage Gain, $T_A = +25^\circ\text{C}$ $T_A = T_{low}$ to T_{high}	A_{vol}	—	—	—	3000	5000	—	V/V	
		4500	5000	12,500	—	—	—		
Bandwidth (Open-Loop, -3.0 dB, no roll-off capacitance)	BW	1.0	2.0	—	1.0	2.0	—	MHz	
Output Impedance ($f = 100$ Hz)	z_o	—	25	50	—	25	50	ohms	
Output Voltage Swing ($R_L = 1.0$ k ohms)	V_O	± 4.5	± 5.2	—	± 4.0	± 5.0	—	V _{pk}	
Power Supply Sensitivity ($R_S \leq 10$ k Ω)	PSRR	—	100	—	—	100	—	$\mu\text{V/V}$	
Power Supply Current	I_{CC}, I_{EE}	—	9.2	12.5	—	9.2	12.5	mAdc	
DC Quiescent Power Consumption ($V_O = 0$)	P_C	—	110	150	—	110	150	mW	

ELECTRICAL CHARACTERISTICS ($V_{CC} = +6.0$ Vdc, $V_{EE} = -6.0$ Vdc, $T_A = +25^\circ\text{C}$ unless otherwise noted)

Characteristic	Symbol	MC1531			MC1431			Unit	
		Min	Typ	Max	Min	Typ	Max		
Input Bias Current	I_{IB}	—	0.025	0.150	—	0.1	0.3	μAdc	
Input Offset Current	I_{IO}	—	0.003	0.025	—	0.01	0.1	μAdc	
Input Offset Voltage	V_{io}	$T_A = +25^\circ\text{C}$	—	3.0	10	—	5.0	15	mVdc
		$T_A = T_{low}$ ①	—	—	18	—	—	—	
		$T_A = T_{high}$ ①	—	—	16.5	—	—	—	
Single-Ended Input Impedance (Open-Loop, $f = 30$ Hz)	z_{is}	1000	2000	—	300	600	—	k Ω	
Common-Mode Input Voltage Swing	V_{ICR}	± 2.0	± 2.4	—	± 2.0	± 2.2	—	V _{pk}	
Equivalent Input Noise Voltage (Open-Loop, $R_s = 50$ ohms, BW = 5.0 MHz)	e_N	—	20	—	—	20	—	$\mu\text{V(rms)}$	
Common-Mode Rejection Ratio ($f = 100$ Hz)	CMRR	65	65	—	60	75	—	dB	
Open-Loop Voltage Gain, $T_A = +25^\circ\text{C}$ $T_A = T_{low}$ to T_{high}	A_{vol}	—	—	—	1500	3500	—	V/V	
		2500	3500	7000	—	—	—		
Bandwidth (Open-Loop, -3.0 dB, no roll-off capacitance)	BW	—	0.4	—	—	0.4	—	MHz	
Output Impedance ($f = 30$ Hz)	z_o	—	25	50	—	25	50	ohms	
Output Voltage Swing ($R_L = 1.0$ k ohms)	V_O	± 4.5	± 5.2	—	± 4.0	± 5.0	—	V _{pk}	
Power Supply Sensitivity ($R_S \leq 10$ k Ω)	PSRR	—	100	—	—	100	—	$\mu\text{V/V}$	
Power Supply Current	I_{CC}, I_{EE}	—	9.2	12.5	—	9.2	12.5	mAdc	
DC Quiescent Power Consumption ($V_O = 0$)	P_C	—	110	150	—	110	150	mW	

STEP RESPONSE, TYPICAL CHARACTERISTICS

($V_{CC} = +6.0$ Vdc, $V_{EE} = -6.0$ Vdc, $V_O = 400$ mVdc, $T_A = +25^\circ\text{C}$)

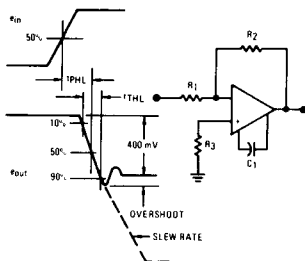

Step Response	Symbol	MC1530	MC1531	Unit
		MC1430	MC1431	
Gain = 100, 0% overshoot, $R_1 = 1.0$ k ohm, $R_2 = 100$ k ohms, $R_3 = 1.0$ k ohm, $C_1 = 750$ pF	t _{THL}	0.13	0.36	μs
	t _{PHL}	0.11	0.21	μs
	SR	33	16	V/ μs
Gain = 10, 10% overshoot, $R_1 = 10$ k ohms, $R_2 = 100$ k ohms, $R_3 = 10$ k ohms, $C_1 = 6800$ pF	t _{THL}	0.34	0.30	μs
	t _{PHL}	0.25	0.28	μs
	SR	6.0	5.5	V/ μs
Gain = 1.0, 5.0% overshoot, $R_1 = 10$ k ohms, $R_2 = 10$ k ohms, $R_3 = 5.0$ k ohms, $C_1 = 33,000$ pF	t _{THL}	0.28	0.37	μs
	t _{PHL}	0.16	0.17	μs
	SR	1.7	1.4	V/ μs

① T_{low} 0°C for MC1430
 -55°C for MC1530
 T_{high} $+75^\circ\text{C}$ for MC1430
 $+125^\circ\text{C}$ for MC1530

T_{low} 0°C for MC1431
 -55°C for MC1531
 T_{high} $+75^\circ\text{C}$ for MC1431
 $+125^\circ\text{C}$ for MC1531

FIGURE 3 – TEST CIRCUIT

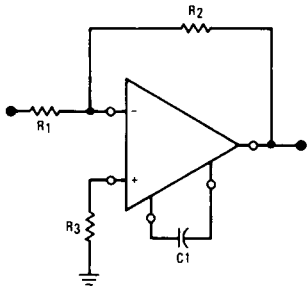

TYPICAL OUTPUT CHARACTERISTICS

($V_{CC} = +6.0$ Vdc, $V_{EE} = -6.0$ Vdc, $T_A = +25^\circ\text{C}$)

FIG. NO.	CURVE NO.	VOLTAGE GAIN	DEVICE NO.	TEST CONDITIONS			
				R ₁ (k Ω)	R ₂ (k Ω)	R ₃ (Ω)	C ₁ (μF)
5	1, 2	100	MC1530/MC1430, MC1531/MC1431	1.0	100	1.0 k	750
	3			10	100	10 k	6800
	4			1	10	10	5.0 k
6	1	100	MC1530/MC1430	1.0	100	1.0 k	750
	2			10	100	10 k	6800
	3			10	10	1.0 k	6800
	4			1	10	5.0 k	33,000
	5			1	1.0	1.0	500
7	1	100	MC1531/MC1431	1.0	100	1.0 k	750
	2			10	100	10 k	6800
	3			1	10	5.0 k	33,000
8	1	AVOL	MC1530/MC1430	0	-	0	0
	2			0	-	0	750
	3			0	-	0	6800
	4			0	-	0	33,000
9	1	AVOL	MC1531/MC1431	0	-	0	0
	2			0	-	0	750
	3			0	-	0	6800
	4			0	-	0	33,000

FIGURE 4 – LARGE SIGNAL SWING versus FREQUENCY

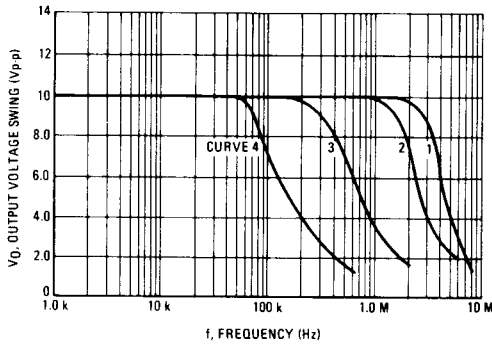

FIGURE 5 – MC1530/MC1430 VOLTAGE GAIN versus FREQUENCY

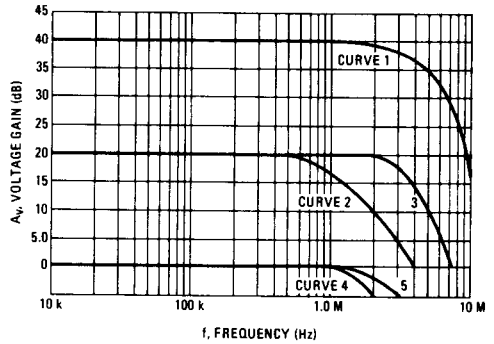

FIGURE 6 – MC1531/MC1431 VOLTAGE GAIN versus FREQUENCY

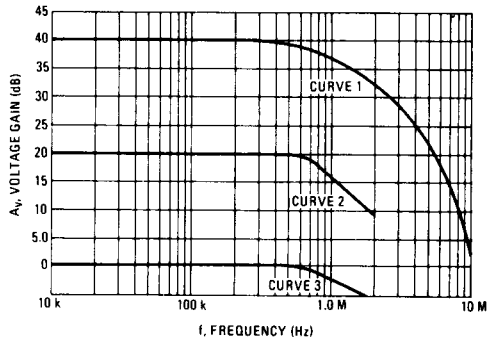

FIGURE 7 – MC1530/MC1430 OPEN LOOP VOLTAGE GAIN versus FREQUENCY

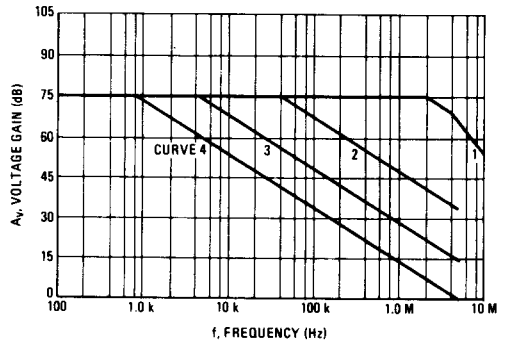

FIGURE 8 – MC1531/MC1431 OPEN LOOP VOLTAGE GAIN versus FREQUENCY

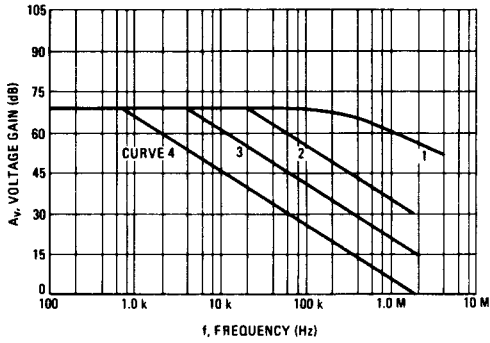

FIGURE 11 – COMMON-MODE SWING versus POWER SUPPLY VOLTAGE

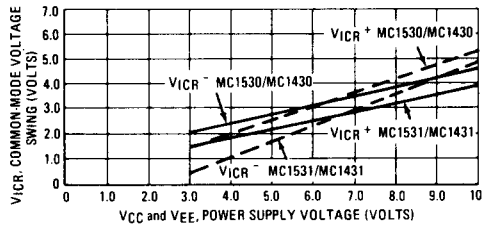

FIGURE 9 – VOLTAGE GAIN versus POWER SUPPLY VOLTAGE

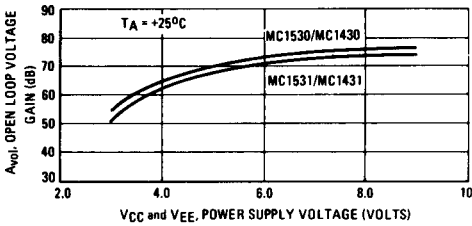

FIGURE 12 – POWER CONSUMPTION versus POWER SUPPLY VOLTAGE

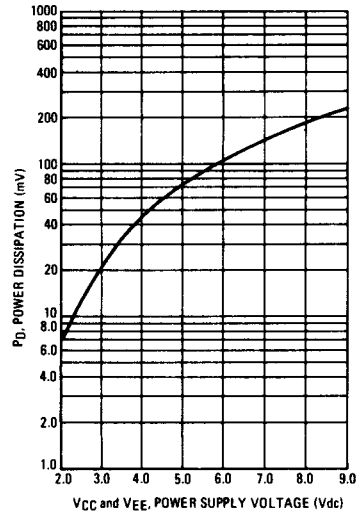

FIGURE 10 – OUTPUT VOLTAGE SWING versus LOAD RESISTANCE

