

TECHNICAL CHARACTERISTICS

MATERIAL
 CONTACT MATERIAL: PHOSPHOR BRONZE
 CONTACT TYPE: STAMPED
 CONTACT PLATING: TIN
 QUALITY CLASS: 25 MATING CYCLES
 PITCH: FOR 1.00 MM

ENVIRONMENTAL
 OPERATING TEMPERATURE: -25 UP TO 85°C
 COMPLIANCE: LEAD FREE AND ROHS

ELECTRICAL
 CURRENT RATING: 1A
 WORKING VOLTAGE: 50V AC
 CONTACT RESISTANCE: 20 mΩ MAX

WIRE DIMENSION:
 AWG: AWG 32 - 28

PACKAGING
 BULK/LOOSE DELIVERY IN A BAG
 EACH CONTACT SEPARATED FROM EACH OTHER
 NOT ON A REEL
 100PCS/PER BAG. MULTIPLE OF 100PCS ONLY
 1PCS OF 66500113722DEC=1 CRIMP CONTACT
 SO 1 BAG MEANS 100 PCS OF 66500113722DEC

RoHS Compliant				PROJECTION: 	GENERAL TOLERANCE .X = +/- 0.2 .XX = +/- 0.15		
G							
F							
E							
D				APPROVAL: BBu	UNIT: MM	DESCRIPTION: WR-WTB 1.00 MM FEMALE CRIMP TERMINAL WERI PART NO: 665 001 137 22 DEC	SIZE A4
B	08-AUG-17	TPK	AK		SCALE:		
A	16-JUL-14	PDF	AS		SHEET: 1/3		
REV	DATE	FILE	BY				

1

2

3

4

5

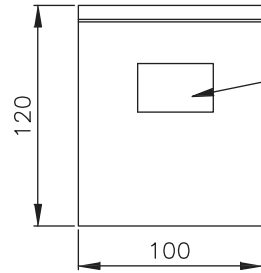
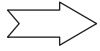
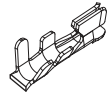

Packing Quantity: 100 pcs/Bag

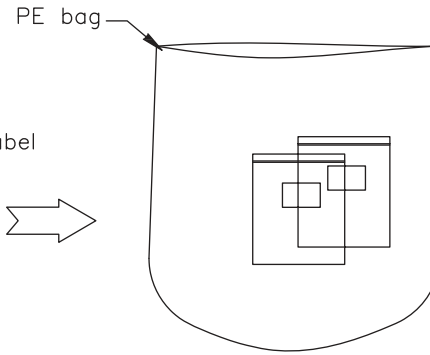

50 Bag/PE Bag
PE Bag: 250*300*0.08

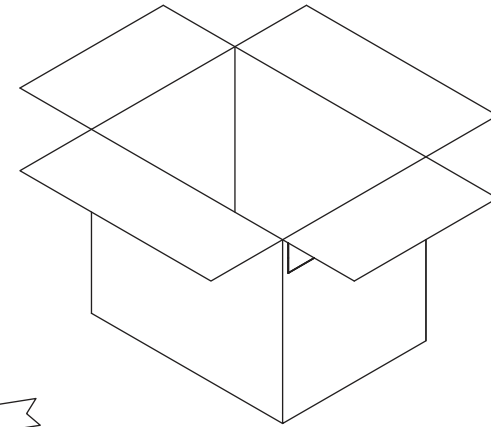

Packing Quantity: 900 Bag/Carton
90Kpcd/Carton

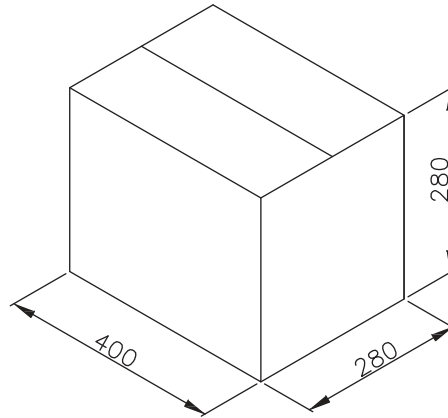

A

B

C

D

RoHS Compliant			
G			
F			
E			
D			
C			
B			
A			
REV	DATE	FILE	BY

PROJECTION:

GENERAL TOLERANCE
.X = +/- 0.2
.XX = +/- 0.15



APPROVAL: BBu

UNIT: MM
SCALE:
SHEET: 2/3

DESCRIPTION: WR-WTB 1.00 MM FEMALE CRIMP TERMINAL
WERI PART NO: 665 001 137 22 DEC

SIZE
A4

1

2

3

4

5

Cautions and Warnings:

This electronic component is designed and developed with the intention for use in general electronics equipments.



Before incorporating the components into any equipments in the field such as aerospace, aviation, nuclear control, submarine, transportation, (automotive control, train control, ship control), transportation signal, disaster prevention, medical, public information network etc. where higher safety and reliability are especially required or if there is possibility of direct damage or injury to human body, Würth Elektronik must be asked for a written approval.

In addition, even electronic component in general electronic equipments, when used in electrical circuits that require high safety, reliability functions or performance, the sufficient reliability evaluation-check for the safety must be performed before by the user before usage.

A

B

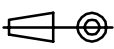
C

RoHS Compliant				PROJECTION: 	GENERAL TOLERANCE .X = +/- 0.2 .XX = +/- 0.15	 WÜRTH ELEKTRONIK	DESCRIPTION: DISCLAIMER	SIZE A4
G								
F								
E								
D								
C				APPROVAL: JC	UNIT: MM	WERI PART NO: DISCLAIMER	SIZE A4	
B					SCALE:			
A	10-SEP-14	PDF	QL		SHEET: 3/3			
REV	DATE	FILE	BY		DRAW: QL			

D