

2302493-1 ✓ ACTIVE

AMP | AMPSEAL 16

TE Internal #: 2302493-1

Automotive Connector Caps & Covers, Backshell, Black, PA, 6

Position, -40 – 257 °F [-40 – 125 °C], AMPSEAL 16

[View on TE.com >](#)



Connectors > Automotive Connectors > Automotive Connector Accessories > Automotive Connector Caps & Covers >

AMPSEAL 16 Connectors Backshell



Protection & Strain Relief Accessory Type: **Backshell**

Strain Relief: **With**

Primary Product Color: **Black**

Primary Product Material: **PA**

Number of Positions: **6**

[All AMPSEAL 16 Connectors Backshell \(82\)](#)

## Features

### Product Type Features

Protection & Strain Relief Accessory Type	Backshell
---	-----------

### Configuration Features

Number of Positions	6
---------------------	---

### Body Features

Primary Product Color	Black
-----------------------	-------

Primary Product Material	PA
--------------------------	----

### Mechanical Attachment

Strain Relief	With
---------------	------

### Usage Conditions

Compatible With Connector Style	Housing For Female Terminals, Plug
---------------------------------	------------------------------------

Operating Temperature (Max)	70 °C, 75 °C, 80 °C, 85 °C, 90 °C, 100 °C, 105 °C, 110 °C, 120 °C, 125 °C[158 °F][167 °F][176 °F][185 °F][194 °F][212 °F][221 °F][230 °F]
-----------------------------	---



°F][248 °F][257 °F]

Operating Temperature Range	-40 – 125 °C[-40 – 257 °F]
-----------------------------	----------------------------

**Industry Standards**

UL Flammability Rating	UL 94V-0
------------------------	----------

**Packaging Features**

Packaging Method	Bag & Box
------------------	-----------

**Other**

Serviceable	Yes
-------------	-----

**Product Compliance**

[For compliance documentation, visit the product page on TE.com>](#)

EU RoHS Directive 2011/65/EU	Compliant
EU ELV Directive 2000/53/EC	Compliant
China RoHS 2 Directive MIIT Order No 32, 2016	No Restricted Materials Above Threshold
EU REACH Regulation (EC) No. 1907/2006	Current ECHA Candidate List: JUNE 2023 (235) Candidate List Declared Against: JUNE 2023 (235) Does not contain REACH SVHC
Halogen Content	Low Halogen - Br, Cl, F, I < 900 ppm per homogenous material. Also BFR/CFR/PVC Free
Solder Process Capability	Not applicable for solder process capability

Product Compliance Disclaimer

This information is provided based on reasonable inquiry of our suppliers and represents our current actual knowledge based on the information they provided. This information is subject to change. The part numbers that TE has identified as EU RoHS compliant have a maximum concentration of 0.1% by weight in homogenous materials for lead, hexavalent chromium, mercury, PBB, PBDE, DBP, BBP, DEHP, DIBP, and 0.01% for cadmium, or qualify for an exemption to these limits as defined in the Annexes of Directive 2011/65/EU (RoHS2). Finished electrical and electronic equipment products will be CE marked as required by Directive 2011/65/EU. Components may not be CE marked. Additionally, the part numbers that TE has identified as EU ELV compliant have a maximum concentration of 0.1% by weight in homogenous materials for lead, hexavalent chromium, and mercury, and 0.01% for cadmium, or qualify for an exemption to these limits as defined in the Annexes of Directive 2000/53/EC (ELV). Regarding the REACH Regulation, the information TE provides on SVHC in articles for this part number is based on the latest European Chemicals Agency (ECHA) 'Guidance on requirements for substances in articles' posted at this URL: <https://echa.europa.eu/guidance-documents/guidance-on-reach>

**Compatible Parts**



## Also in the Series | AMPSEAL 16

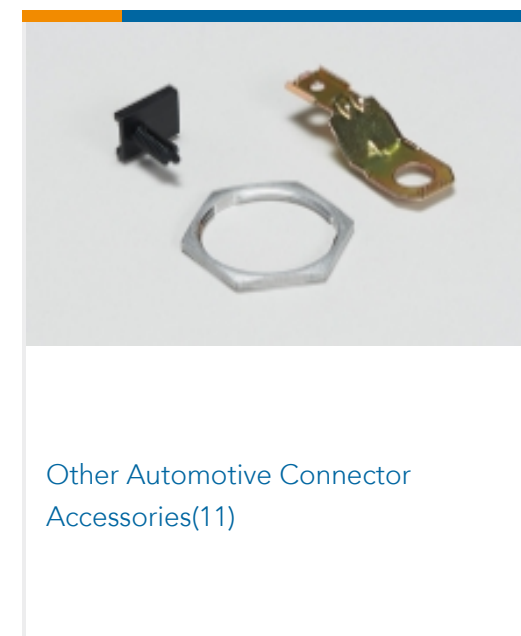
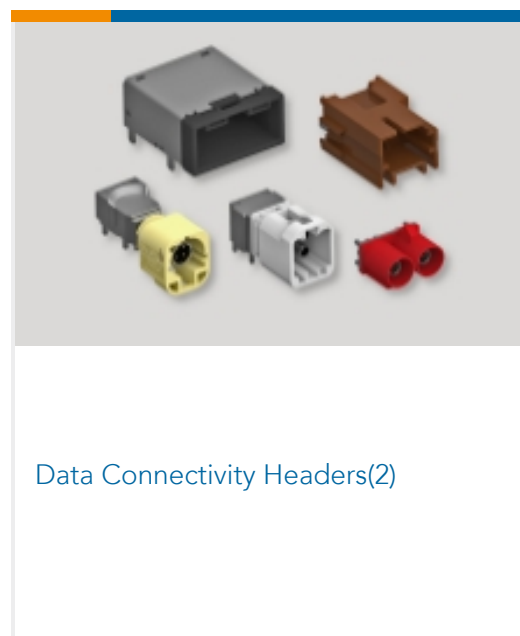
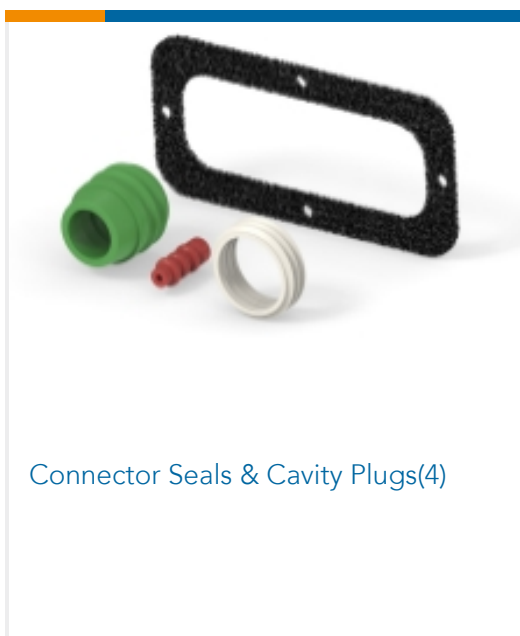
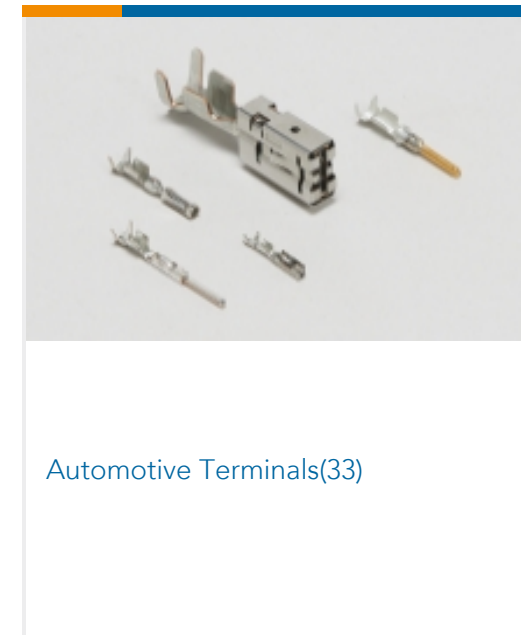
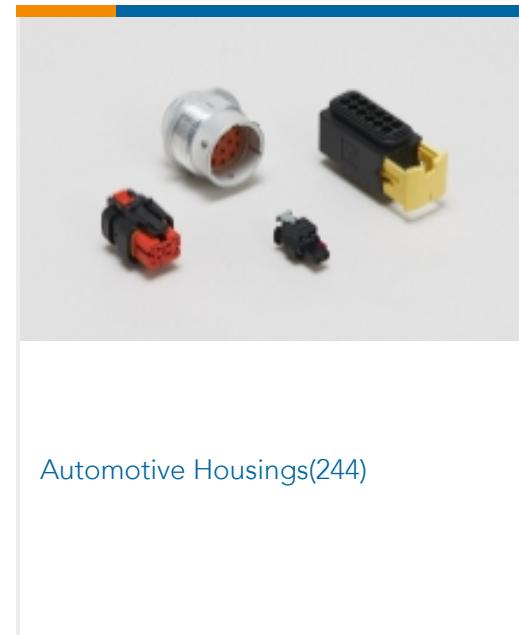
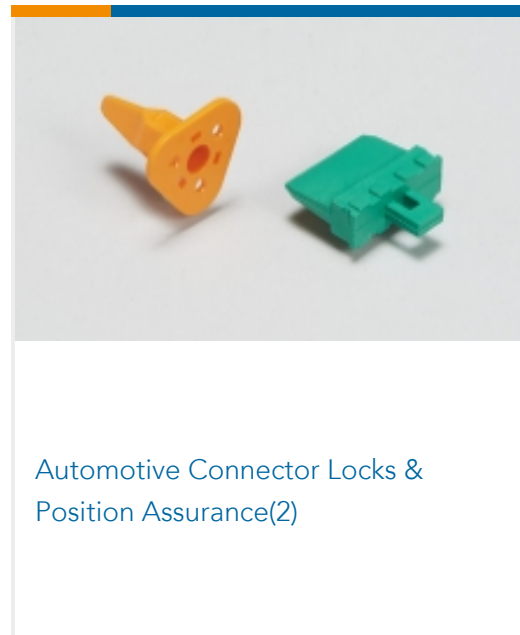
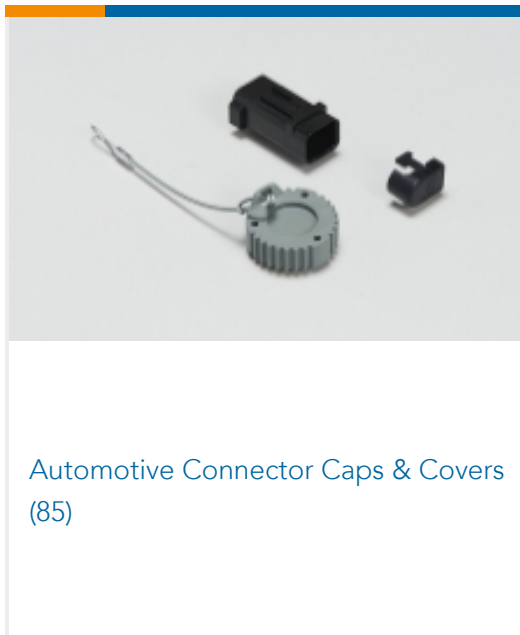

## Customers Also Bought

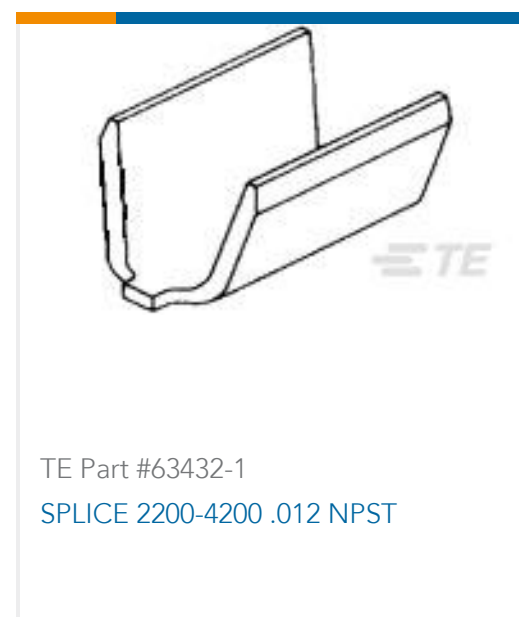



## Documents

### Product Drawings

[SOC CONN CVRASSY,2POS,AMPSEAL16,90DEG,MC](#)

English

---

### CAD Files

[3D PDF](#)

3D

Customer View Model

[ENG\\_CVM\\_CVM\\_2302493-1\\_A.2d\\_dxf.zip](#)

English

Customer View Model

[ENG\\_CVM\\_CVM\\_2302493-1\\_A.3d\\_igs.zip](#)

English

Customer View Model

[ENG\\_CVM\\_CVM\\_2302493-1\\_A.3d\\_stp.zip](#)

English

By downloading the CAD file I accept and agree to the [Terms and Conditions](#) of use.

---

### Datasheets & Catalog Pages

[ICT Terminals and Connectors Catalogue](#)

English

---

### Product Specifications

[Product Specification](#)

English

---

### Instruction Sheets

[Instruction Sheet \(U.S.\)](#)

English