

コイン形二酸化マンガンリチウム電池
Coin manganese dioxide lithium batteries

CR2477W

■外形寸法 Dimensions(mm)

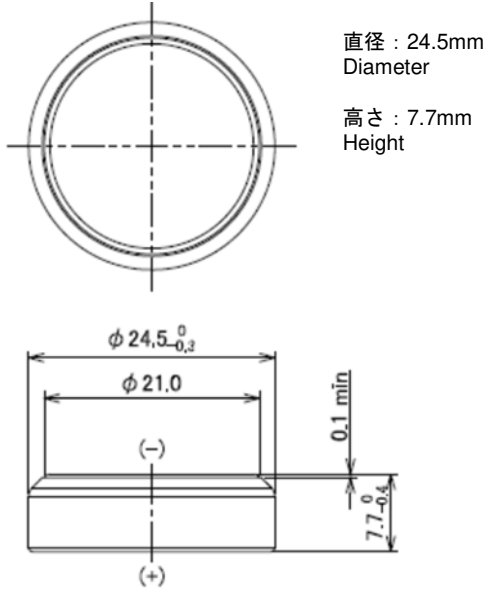

(Unit : mm)

■定格 Specifications

公称電圧 Nominal Voltage	3 V
公称容量 (終止電圧 2.0V) Nominal Capacity (2.0V cutoff)	1000 mAh
推奨連続放電電流値 (容量利用率高) Recommended Continuous Discharge Current (High capacity usage rate)	≤1 mA
標準質量 Weight	11 g
使用温度範囲 Operating Temperature	-40 ~ +125°C

用途 Applications

- TPMS(タイヤ空気圧監視システム)
- ETC
- FA機器
- SRAMやリアルタイムクロック等メモリーバックアップ
- その他高温/低温環境で使われる機器
- TPMS (Tire Pressure Monitoring System)
- ETC (Electronic Toll Collection System)
- Factory Automation Instruments
- Memory Back-up Power Source for SRAM and Real Time Clock (RTC)
- Other devices used in wide temperature environment

UL認定合格部品 UL Recognized components

- 許可番号 **Certification number** : MH12566
- User replaceable

■放電特性

Discharge Characteristics

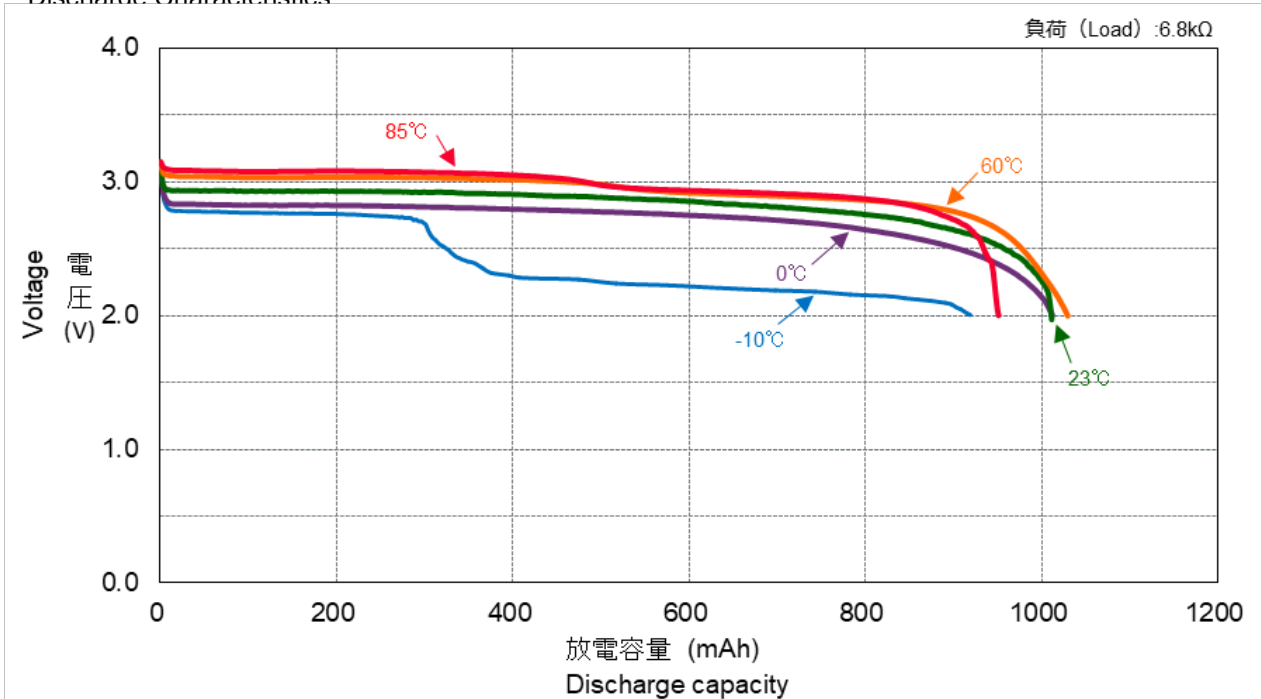

■ 放電負荷特性

Discharge Characteristics by Load

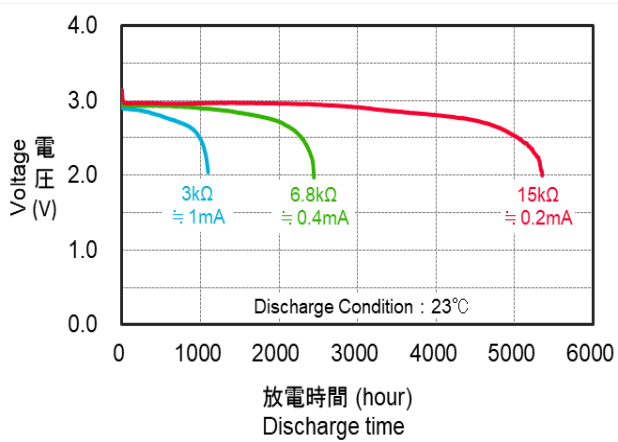

■ 放電温度特性

Discharge Characteristics by Temperature

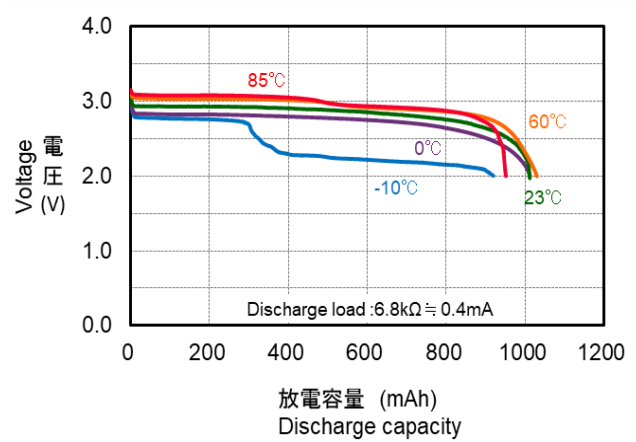

■ 閉路電圧特性

Closed Circuit Voltage by Temperature

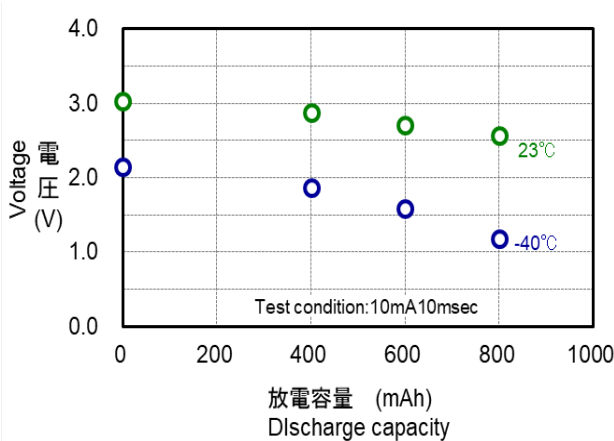

■ 内部抵抗

Impedance by Temperature

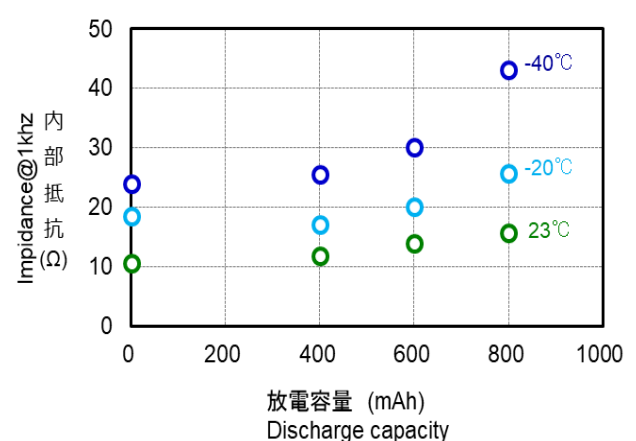

■ 自己放電特性

Self Discharge Characteristic by Temperature

注: 20°C未満の自己放電率は20°Cと同じ自己放電率になります。
 Note: The self-discharge rate of less than 20°C shows the same self-discharge rate as 20°C.

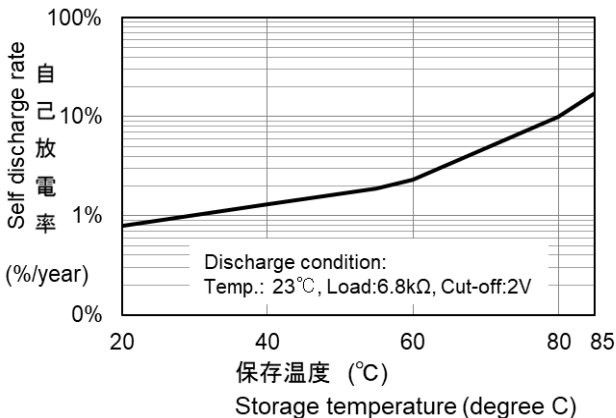

*記載のデータ及び数値は、参考値であり保証値ではありません。

*Data is not guaranteed, and is provided for reference purposes only.