

**Order Number
213309-1600**

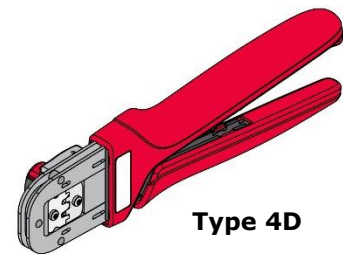

Application Tooling Specification



Type 4D

FEATURES

- A full cycle ratcheting hand tool ensures complete crimps
- Ergonomic soft grip handles for comfortable crimping
- A precision user-friendly terminal locator with wire stop holds terminals in the proper crimping position
- Dies and locator from this tool can be used in the Battery Powered Tool Order No. 63816-0270 (110 V) or 63816-0280 (220 V) with the use of the 63816-0800 Crimp Head
- Many different tool kits can be used with a single Battery Powered Crimp Tool
- This tool is IPC/WHMA-A-620 Class 2 compliant (see Scope table)
- This tool is RoHS compliant; however, RoHS compliance is not required

SCOPE

Products: CP 4.5 Wire-to-Wire Crimp Terminals, 18 AWG Wire.

Terminal Series No.	Terminal Order No.	Wire		▶ Insulation Diameter				Strip Length	
				IPC/WHMA-A-620 (1)		Terminal (2)			
		Wire Type	Wire Size	mm	In.	mm	In.	mm	In.
206999	206999-8000	UL1015	18 AWG	2.60-3.30	.102-.130	2.80	.110	3.30-4.00	.130-.157
	206999-8002								
	206999-8003	UL1007	18 AWG	1.80-2.20	.071-.087	2.00	.079	3.30-4.00	.130-.157

▶ To achieve IPC/WHMA-A-620 Class 2 crimps, the following overall wire insulation diameter ranges are recommended:
 (1) Insulation OD range for optimum (IPC/WHMA-A-620 Class 2) insulation crimps
 (2) Insulation OD range for the terminal product design

DEFINITION OF TERMS

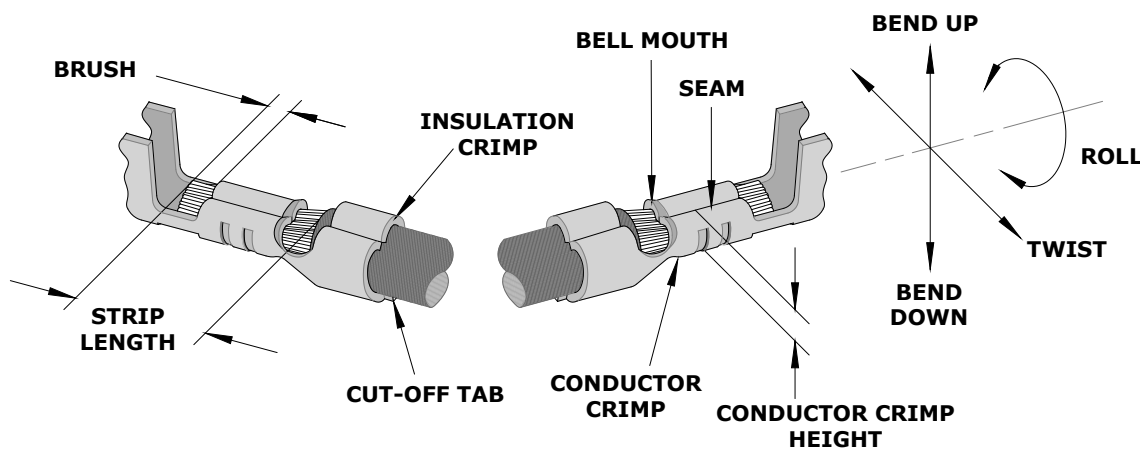

The above terminal drawing is a generic terminal representation. It is not an image of a terminal listed in the scope.

CONDITIONS

After crimping, the crimped terminals should measure as follows:

Terminal Series No.	Bell Mouth		Conductor Brush	
	mm	In.	mm	In.
206999	0.25-.070	.010-.028	0.30-0.90	.012-.035

Terminal Series No.	Bend Up	Bend Down	Twist	Roll	Seam
	Degree Max		Degree Max		
206999	3	3	3	5	Seam shall not be open and no wire allowed out of the crimping area

After crimping, the conductor profiles should measure the following:

Terminal Series No.	Wire		Conductor Crimp Height		Conductor Crimp Width (Ref)		Pull Force Minimum		Profile	
	Wire Type	Wire Size	mm	In.	mm	In.	N	Lb.	A	B
206999	UL1015	18 AWG	1.05-1.15	.041-.045	2.00-2.20	.079-.087	107.9	24.3	X	
	UL1007	18 AWG	1.05-1.15	.041-.045	2.00-2.20	.079-.087	107.9	24.3		X

Terminal Series No.	Wire		Insulation Crimp Height (Ref)		Insulation Crimp Width (Ref)	
	Wire Type	Wire Size	mm	In.	mm	In.
206999	UL1015	18 AWG	3.10-3.30	.122-.130	3.05-3.25	.120-.128
	UL1007	18 AWG	2.65-2.85	.104-.112	2.60-2.80	.102-.110

Tool Qualification Notes

1. (Ref) means that the dimension provided is approximate because of the wide range of wires, conductor stranding, insulation diameter and insulation hardness.
2. An occasional conductor crimp height measurement should be performed. It must lie between the minimum and maximum crimp height specification.
3. Pull force should be measured with no influence from the insulation crimp. To ensure this, strip the wire long enough so the terminal insulation grips do not contact the wire insulation.

Notes

1. This tool should only be used for the terminals and wire gauges specified on this sheet.
2. Variations in tools, terminals, wire stranding and insulation types may affect crimp height.
3. This tool is intended for AWG conductor sizes. It may not give good insulation crimp support for insulation sizes outside of the specified range.
4. Molex does not repair hand tools. See warranty on page 6. The replacement parts listed are the only parts available for repair. If the handles or crimp tooling become damaged or worn, a new tool must be purchased.
5. Conductor crimp height should be used as the final criterion for an acceptable crimp. Refer to Molex Quality Crimping Handbook 63800-0029 for additional information on crimping and crimp testing.
6. Molex does not certify hand crimp tools.

OPERATION

CAUTION: Crimp only the Molex terminals listed in the scope for this tool. Do not crimp hardened objects because damage can occur to the tool frame or crimp dies.

Open the tool by squeezing the handles together. At the end of the closing stroke, the ratchet mechanism will release the handles and the hand tool will spring open. See Figure 1.

Crimping Terminals

1. Select the desired terminal listed in the preceding charts.
2. Make sure the center of the locator is in the down position. With the locator attached, push the locator button on the back of the hand tool to bring the locator forward through the tooling. See Figure 2.
3. While holding the locator button in, load the terminal into the proper nest opening in the locator based on the wire gauge or terminal type markings on the hand tool. See Figure 3.

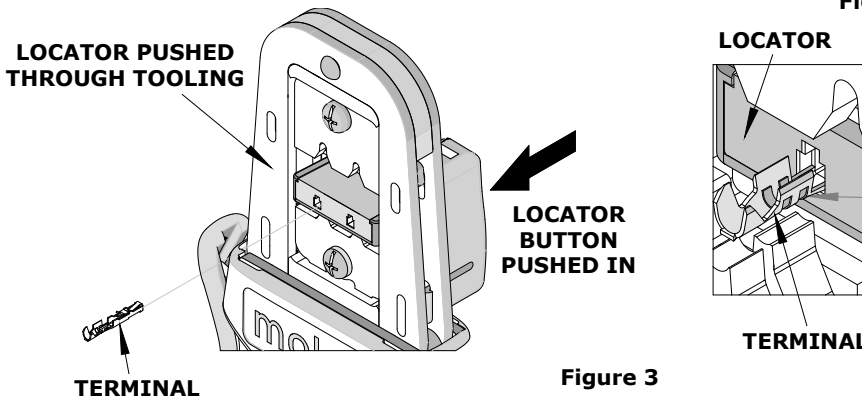
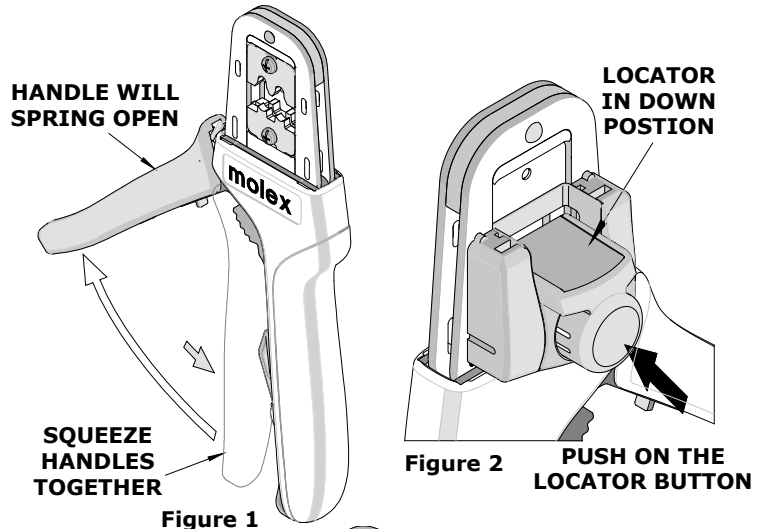

4. Release the locator button, allowing the locator to return to the crimping position.
5. Close the tool handle until the first ratchet position engages. See Figure 4.
6. Insert the properly stripped wire through the terminal and against the locator. See Figure 5.
7. Crimp the terminal by squeezing the tool handles until the ratchet mechanism cycle has been completed. Release the handles to open the jaws.

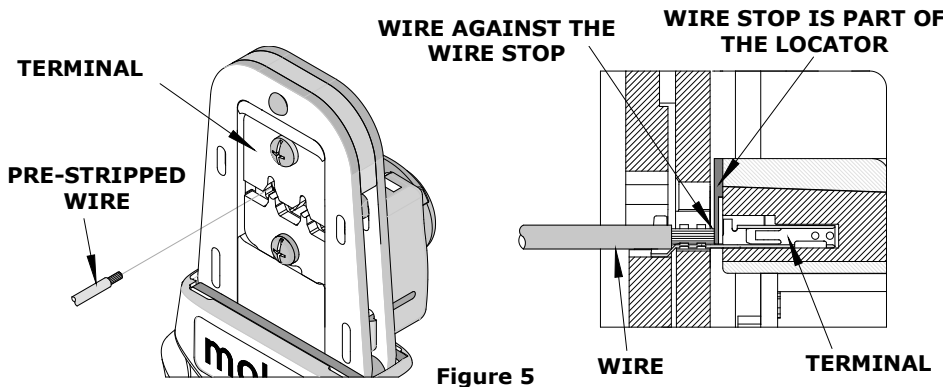
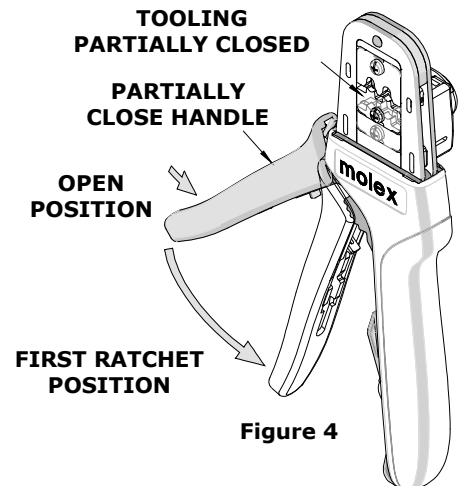

Note: The tamper-proof ratchet action will not release the tool until it has been fully closed.

8. Remove the crimped terminal from the terminal locator by pulling on the wire.
9. Visually inspect the crimped terminal for proper crimp location.
10. On some large O.D. wires, it may not be possible to insert the wire with the tool partially closed. Those wires should be inserted with the hand tool in the open position. Insert the wire above the terminal in the punch and against the wire stop, and then close the tool. See Figure 6.

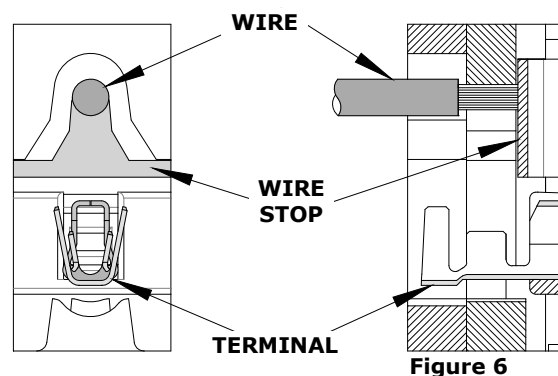

Figure 6

Locator Installation

See the parts list on the last page of this document for the proper locator order number. Follow the steps below to replace the locator:

1. Open the hand crimp tool.
2. Squeeze gently on the lower area shown in Figure 7A with your thumb and index finger. The lower tabs of the locator should disengage from the hand tool.
3. Lift and pull away from the hand tool. The top locator hooks should slip out of the top slots easily. See Figure 7A.
4. To reinstall the locator, make sure the hand tool is in the open position.
5. Press the center of the locator down as far as it will go as shown in Figure 7B.
6. Holding onto the lower part of the locator with your thumb and index finger, insert the locator's top hooks into the hand tool's top slots.
7. Rotate the locator down and press the lower tabs into the two bottom slots of the hand tool. To secure the locator into place, the lower tabs must snap into place on the hand tool frame.

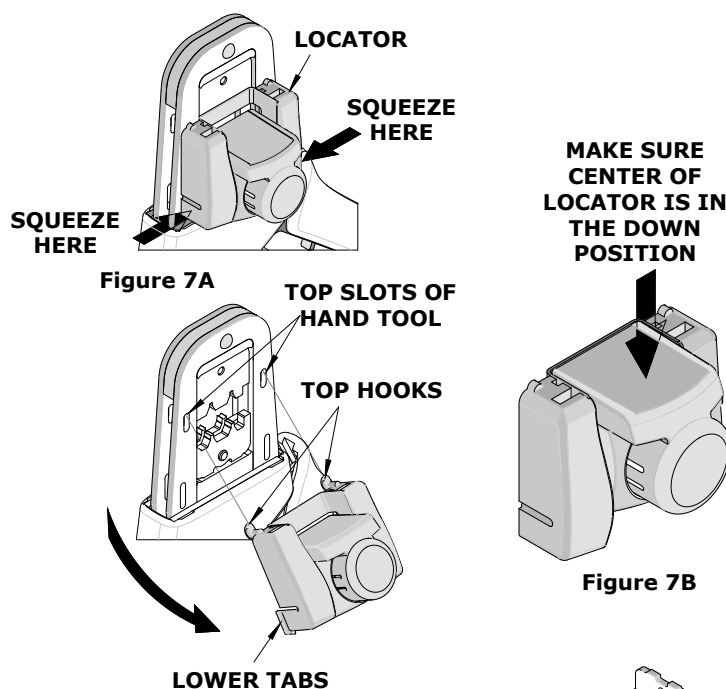

Figure 7A

Figure 7B

Right- or Left-Handed Operation

This hand tool can be converted from a right-handed application to a left-handed application. It is necessary to reverse the tooling if using the left-handed application along with the locator. Follow the steps below:

1. The locator must be removed before reversing the tooling.
2. Remove the M3 BHCS, which is holding the upper tooling.

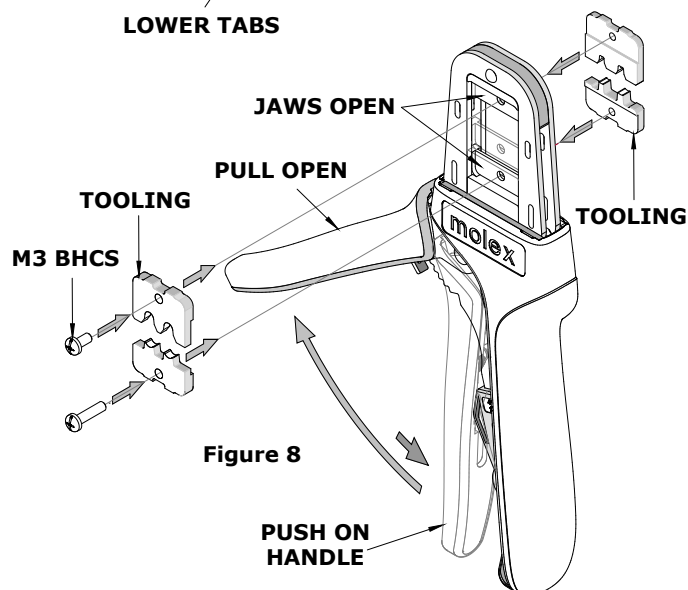
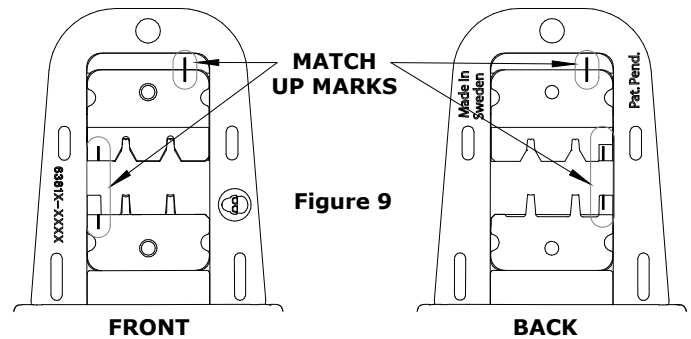

Figure 8

3. Flip the upper tooling to the opposite side and replace the M3 BHCS. Make sure the small markings on the front and back of the hand tool frame match up and are on the outside of the hand tool frame. See Figures 8 and 9.
4. Do the same thing with the lower tooling and tighten the M3 screws. Be sure the small markings line up.
5. Reinstall the locator by following the instructions in the locator replacement section.



MAINTENANCE

It is recommended that each operator of the tool be made aware of and responsible for the following maintenance steps:

1. Remove dust, moisture and other contaminants with a clean brush or a soft, lint-free cloth.
2. Do not use any abrasive materials that could damage the tool.
3. Make certain all pins, pivot points and bearing surfaces are protected with a thin coat of high-quality machine oil. Do not oil excessively. The tool was engineered for durability, but like any other equipment, it needs cleaning and lubrication for a maximum service life of trouble-free crimping. Light oil (such as 30 weight automotive oil) used at the oil points every 5,000 crimps or 3 months will significantly enhance the tool life. See Figure 10.
4. Wipe excess oil from the hand tool, particularly from crimping area. Oil transferred from the crimping area onto certain terminations may affect the electrical characteristics of an application.
5. When the tool is not in use, keep the handles closed to prevent objects from becoming lodged in the crimping dies, and store the tool in a clean, dry area.

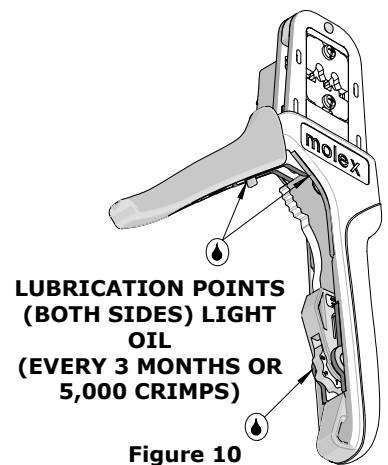

Miscrimps or Jams

Should this tool ever become stuck or jammed in a partially closed position, **do not force the handles open or closed**. The tool will open easily by pressing up on the ratchet release lever in the movable handle. See Figure 11.

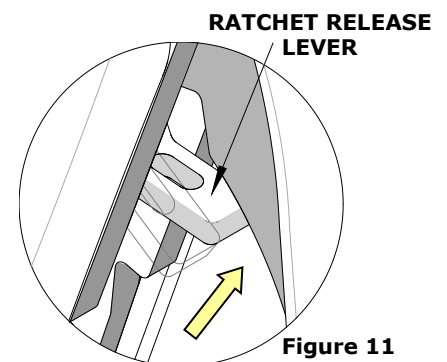

How to Adjust Tool Preload (See Figure 12)

Hand tool frame preload is factory preset to ensure crimp quality. It may be necessary over the life of the tool to adjust tool handle preload force. Listed below are the steps required to adjust the crimping force of the hand tool to obtain proper crimp conditions:

1. Open the hand tool.
2. Close the handle 2 ratchet clicks.
3. Hold the hand tool in the palm of your hand as shown in Figure 12. Using your index finger, squeeze the link toward the top of the hand tool frame. This will release the preload adjustment wheel.
4. Rotate the setting wheel counterclockwise (CCW) to increase handle force. The numbers will display higher. To decrease handle force, rotate the setting wheel clockwise (CW).
5. Release the link to lock the setting wheel in place.
6. Check the crimp specifications or conduct a pull test after tool handle preload force is adjusted.

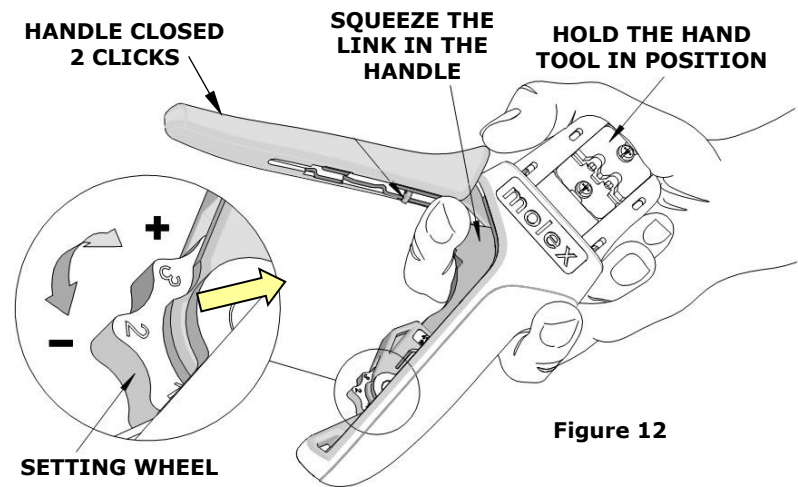

Figure 12

WARRANTY

This tool is for electrical terminal crimping purposes only. This tool is made of the best quality materials. All vital components are long-life tested. All tools are warranted to be free of manufacturing defects for a period of 30 days. Should such a defect occur, Molex will repair or exchange the tool free of charge. This repair or exchange will not be applicable to altered, misused or damaged tools. This tool is designed for hand use only. Any clamping, fixturing or use of handle extensions voids this warranty.

CAUTION: Molex crimp specifications are valid only when used with Molex terminals and tooling.

CAUTIONS:

1. Manually powered hand tools are intended for low-volume use or field repair. This tool is **NOT** intended for production use. Repetitive use of this tool should be avoided.
2. Insulated rubber handles are not protection against electrical shock.
3. Wear eye protection at all times.
4. Use only the Molex terminals specified for crimping with this tool.

Certification

Molex does not certify or re-certify hand tools but rather supplies the following guidelines for customers to re-certify hand tools:

- This tool is qualified to pull force only. See the Molex website for the Quality Crimp Handbook for more information on pull testing.
- If the tool does not meet minimum pull force values, handle preload should be increased and the pull test rerun (see How to Adjust Preload).
- When the hand tool is no longer capable of achieving minimum pull force, it should be taken out of service and replaced.

PARTS LIST

Item Number	Order Number	Description	Quantity
REF	213309-1600	Hand Crimp Tool	Figure 13
1	213309-1675	Locator Assembly	1
2	63810-0104	Spring, Return	1
3	63810-0105	Spring, Ratchet	1

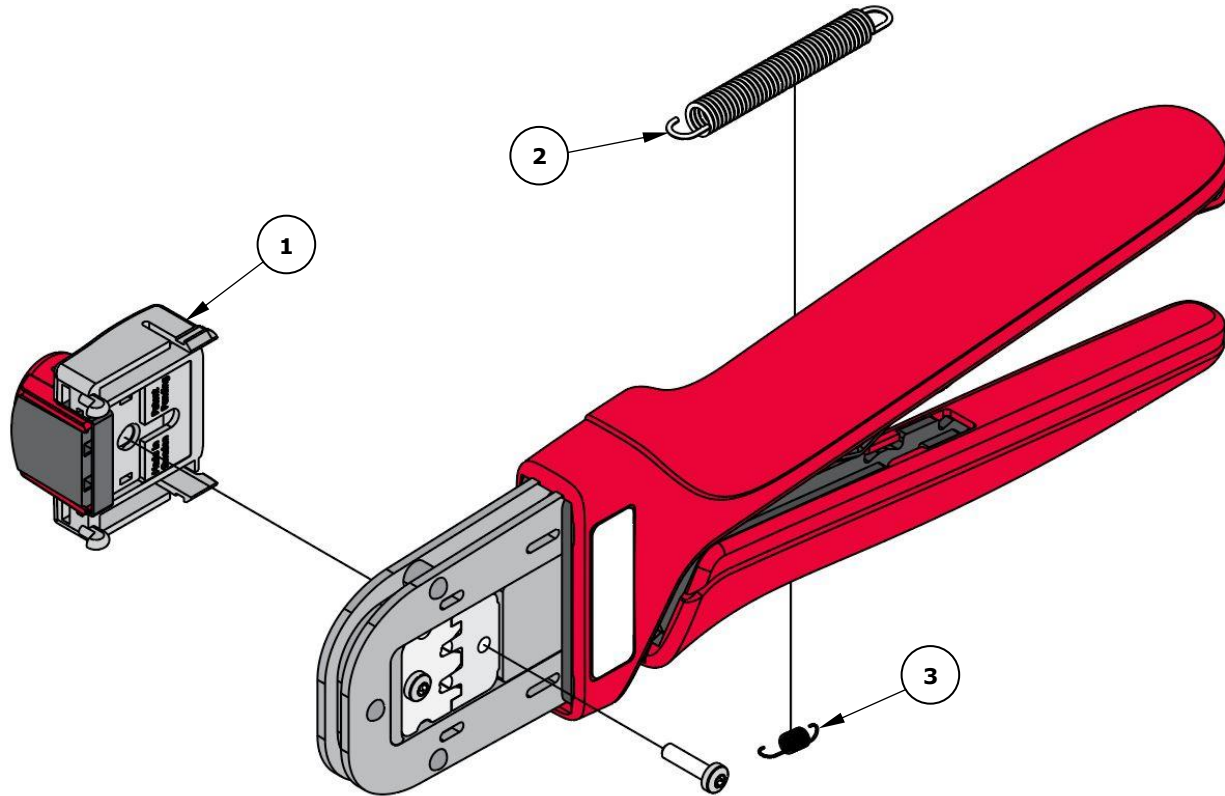

Figure 13

Application Tooling Support

Phone: (402) 458-TOOL (8665)

E-Mail: applicationtooling@molex.com

Website: www.molex.com/applicationtooling

Molex is a registered trademark of Molex, LLC in the United States of America and may be registered in other countries; all other trademarks listed herein belong to their respective owners.