

RF Power Field Effect Transistors

N-Channel Enhancement-Mode Lateral MOSFETs

Designed for CDMA and multicarrier GSM base station applications with frequencies from 860 to 960 MHz. Can be used in Class AB and Class C for all typical cellular base station modulation formats.

- Typical Single-Carrier W-CDMA Performance: $V_{DD} = 28$ Volts, $I_{DQ} = 2400$ mA, $P_{out} = 100$ Watts Avg., IQ Magnitude Clipping, Channel Bandwidth = 3.84 MHz, Input Signal PAR = 7.5 dB @ 0.01% Probability on CCDF.

Frequency	G_{ps} (dB)	η_D (%)	Output PAR (dB)	ACPR (dBc)
920 MHz	19.6	35.4	6.0	-37.3
940 MHz	19.6	35.6	6.0	-37.1
960 MHz	19.4	35.8	5.9	-36.7

- Capable of Handling 10:1 VSWR, @ 32 Vdc, 940 MHz, 425 Watts CW Output Power (3 dB Input Overdrive from Rated P_{out}), Designed for Enhanced Ruggedness
- Typical P_{out} @ 1 dB Compression Point ≈ 326 Watts CW

880 MHz

- Typical Single-Carrier W-CDMA Performance: $V_{DD} = 28$ Volts, $I_{DQ} = 2400$ mA, $P_{out} = 100$ Watts Avg., IQ Magnitude Clipping, Channel Bandwidth = 3.84 MHz, Input Signal PAR = 7.5 dB @ 0.01% Probability on CCDF.

Frequency	G_{ps} (dB)	η_D (%)	Output PAR (dB)	ACPR (dBc)
865 MHz	20.5	35.2	6.0	-36.1
880 MHz	20.7	36.0	6.0	-36.1
895 MHz	20.6	37.0	6.0	-35.8

Features

- 100% PAR Tested for Guaranteed Output Power Capability
- Characterized with Series Equivalent Large-Signal Impedance Parameters and Common Source S-Parameters
- Internally Matched for Ease of Use
- Integrated ESD Protection
- Greater Negative Gate-Source Voltage Range for Improved Class C Operation
- Designed for Digital Predistortion Error Correction Systems
- Optimized for Doherty Applications
- RoHS Compliant
- In Tape and Reel. R6 Suffix = 150 Units per 56 mm, 13 inch Reel.

Table 1. Maximum Ratings

Rating	Symbol	Value	Unit
Drain-Source Voltage	V_{DSS}	-0.5, +70	Vdc
Gate-Source Voltage	V_{GS}	-6.0, +10	Vdc
Operating Voltage	V_{DD}	32, +0	Vdc
Storage Temperature Range	T_{stg}	-65 to +150	$^{\circ}C$
Case Operating Temperature	T_C	150	$^{\circ}C$
Operating Junction Temperature (1,2)	T_J	225	$^{\circ}C$

1. Continuous use at maximum temperature will affect MTTF.
2. MTTF calculator available at <http://www.freescale.com/rf>. Select Software & Tools/Development Tools/Calculators to access MTTF calculators by product.

MRF8P9300HR6
MRF8P9300HSR6

920-960 MHz, 100 W AVG., 28 V
SINGLE W-CDMA
LATERAL N-CHANNEL
RF POWER MOSFETs

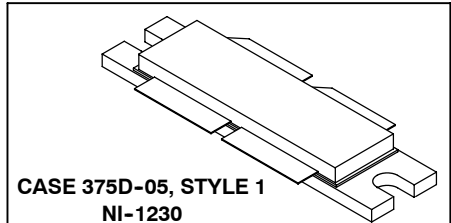

CASE 375D-05, STYLE 1
NI-1230
MRF8P9300HR6

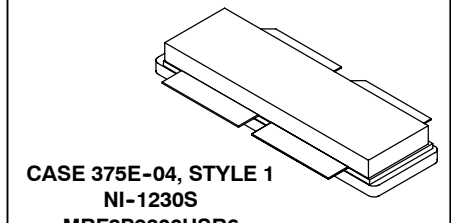

CASE 375E-04, STYLE 1
NI-1230S
MRF8P9300HSR6

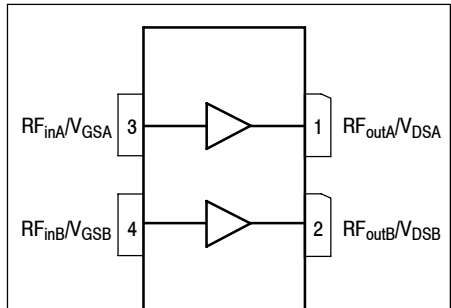

(Top View)

Figure 1. Pin Connections

Table 2. Thermal Characteristics

Characteristic	Symbol	Value (1,2)	Unit
Thermal Resistance, Junction to Case Case Temperature 75°C, 100 W CW, 28 Vdc, I _{DQ} = 2400 mA Case Temperature 80°C, 300 W CW, 28 Vdc, I _{DQ} = 2400 mA	R _{θJC}	0.22 0.20	°C/W

Table 3. ESD Protection Characteristics

Test Methodology	Class
Human Body Model (per JESD22-A114)	2 (Minimum)
Machine Model (per EIA/JESD22-A115)	A (Minimum)
Charge Device Model (per JESD22-C101)	IV (Minimum)

Table 4. Electrical Characteristics (T_A = 25°C unless otherwise noted)

Characteristic	Symbol	Min	Typ	Max	Unit
----------------	--------	-----	-----	-----	------

Off Characteristics ⁽³⁾

Zero Gate Voltage Drain Leakage Current (V _{DS} = 70 Vdc, V _{GS} = 0 Vdc)	I _{DSS}	—	—	10	μAdc
Zero Gate Voltage Drain Leakage Current (V _{DS} = 28 Vdc, V _{GS} = 0 Vdc)	I _{DSS}	—	—	1	μAdc
Gate-Source Leakage Current (V _{GS} = 5 Vdc, V _{DS} = 0 Vdc)	I _{GSS}	—	—	1	μAdc

On Characteristics

Gate Threshold Voltage ⁽³⁾ (V _{DS} = 10 Vdc, I _D = 400 μAdc)	V _{GS(th)}	1.5	2.3	3	Vdc
Gate Quiescent Voltage (V _{DD} = 28 Vdc, I _{DQ} = 2400 mA, Measured in Functional Test)	V _{GS(Q)}	2.3	3.1	3.8	Vdc
Drain-Source On-Voltage ⁽³⁾ (V _{GS} = 10 Vdc, I _D = 3 Adc)	V _{DS(on)}	0.1	0.2	0.3	Vdc

Functional Tests ⁽⁴⁾ (In Freescale Test Fixture, 50 ohm system) V_{DD} = 28 Vdc, I_{DQ} = 2400 mA, P_{out} = 100 W Avg., f = 960 MHz, Single-Carrier W-CDMA, IQ Magnitude Clipping, Input Signal PAR = 7.5 dB @ 0.01% Probability on CCDF. ACPR measured in 3.84 MHz Channel Bandwidth @ ±5 MHz Offset.

Power Gain	G _{ps}	18.0	19.4	21.0	dB
Drain Efficiency	η _D	32.0	35.8	—	%
Output Peak-to-Average Ratio @ 0.01% Probability on CCDF	PAR	5.6	5.9	—	dB
Adjacent Channel Power Ratio	ACPR	—	-36.7	-34.0	dBc
Input Return Loss	IRL	—	-16	-10	dB

Typical Broadband Performance (In Freescale Test Fixture, 50 ohm system) V_{DD} = 28 Vdc, I_{DQ} = 2400 mA, P_{out} = 100 W Avg., Single-Carrier W-CDMA, IQ Magnitude Clipping, Input Signal PAR = 7.5 dB @ 0.01% Probability on CCDF. ACPR measured in 3.84 MHz Channel Bandwidth @ ±5 MHz Offset.

Frequency	G _{ps} (dB)	η _D (%)	Output PAR (dB)	ACPR (dBc)	IRL (dB)
920 MHz	19.6	35.4	6.0	-37.3	-9
940 MHz	19.6	35.6	6.0	-37.1	-12
960 MHz	19.4	35.8	5.9	-36.7	-16

1. MTTF calculator available at <http://www.freescale.com/rf>. Select Software & Tools/Development Tools/Calculators to access MTTF calculators by product.
2. Refer to AN1955, *Thermal Measurement Methodology of RF Power Amplifiers*. Go to <http://www.freescale.com/rf>. Select Documentation/Application Notes - AN1955.
3. Each side of device measured separately.
4. Part internally matched both on input and output.

(continued)

Table 4. Electrical Characteristics ($T_A = 25^\circ\text{C}$ unless otherwise noted) (continued)

Characteristic	Symbol	Min	Typ	Max	Unit
Typical Performances (In Freescale Test Fixture, 50 ohm system) $V_{DD} = 28\text{ Vdc}$, $I_{DQ} = 2400\text{ mA}$, 920–960 MHz Bandwidth					
P_{out} @ 1 dB Compression Point, CW	P1dB	—	326	—	W
IMD Symmetry @ 310 W PEP, P_{out} where IMD Third Order Intermodulation $\cong 30\text{ dBc}$ (Delta IMD Third Order Intermodulation between Upper and Lower Sidebands $> 2\text{ dB}$)	IMD _{sym}	—	17	—	MHz
VBW Resonance Point (IMD Third Order Intermodulation Inflection Point)	VBW _{res}	—	30	—	MHz
Gain Flatness in 40 MHz Bandwidth @ $P_{out} = 100\text{ W Avg.}$	G_F	—	0.16	—	dB
Gain Variation over Temperature (-30°C to $+85^\circ\text{C}$)	ΔG	—	0.012	—	dB/ $^\circ\text{C}$
Output Power Variation over Temperature (-30°C to $+85^\circ\text{C}$)	ΔP_{1dB}	—	0.008	—	dBm/ $^\circ\text{C}$

Typical Broadband Performance — 880 MHz (In Freescale 880 MHz Test Fixture, 50 ohm system) $V_{DD} = 28\text{ Vdc}$, $I_{DQ} = 2400\text{ mA}$, $P_{out} = 100\text{ W Avg.}$, Single-Carrier W-CDMA, IQ Magnitude Clipping, Input Signal PAR = 7.5 dB @ 0.01% Probability on CCDF. ACPR measured in 3.84 MHz Channel Bandwidth @ $\pm 5\text{ MHz}$ Offset.

Frequency	G_{ps} (dB)	η_D (%)	Output PAR (dB)	ACPR (dBc)	IRL (dB)
865 MHz	20.5	35.2	6.0	-36.1	-11
880 MHz	20.7	36.0	6.0	-36.1	-14
895 MHz	20.6	37.0	6.0	-35.8	-16

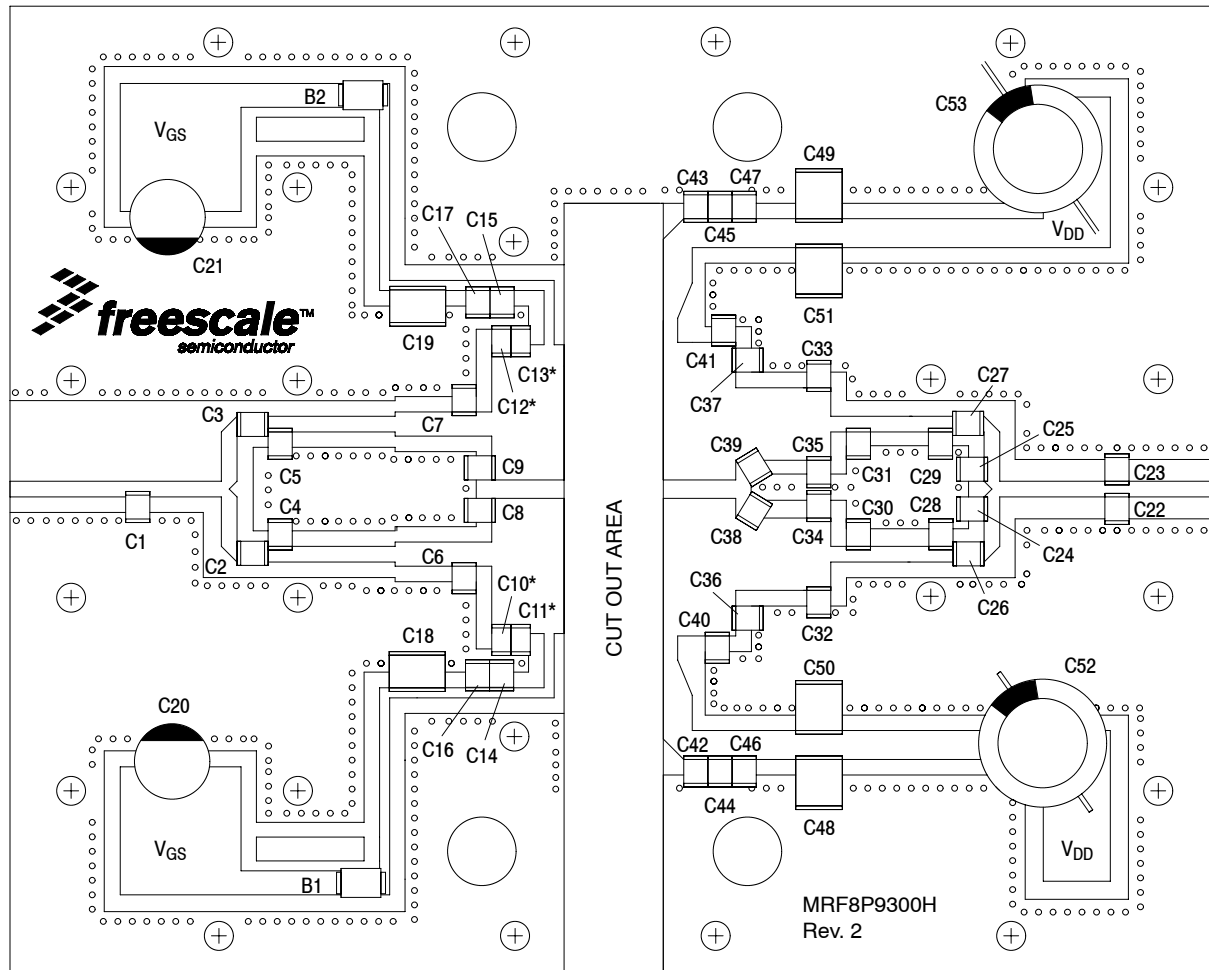

*C10, C11, C12, and C13 are mounted vertically.

Figure 2. MRF8P9300HR6(HSR6) Test Circuit Component Layout

Table 5. MRF8P9300HR6(HSR6) Test Circuit Component Designations and Values

Part	Description	Part Number	Manufacturer
B1, B2	Short RF Bead	2743019447	Fair-Rite
C1	0.2 pF Chip Capacitor	ATC100B0R2BT500XT	ATC
C2, C3, C16, C17, C26, C27	39 pF Chip Capacitors	ATC100B390JT500XT	ATC
C4, C5, C28, C29, C32, C33, C34, C35	1.1 pF Chip Capacitors	ATC100B1R1BT500XT	ATC
C6, C7	2.7 pF Chip Capacitors	ATC100B2R7BT500XT	ATC
C8, C9	5.1 pF Chip Capacitors	ATC100B5R1CT500XT	ATC
C10, C11, C12, C13	3.0 pF Chip Capacitors	ATC100B3R0CT500XT	ATC
C14, C15, C42, C43	10 pF Chip Capacitors	ATC100B100JT500XT	ATC
C18, C19	2.2 μ F, 50 V Chip Capacitors	C1825C225J5RAC-TU	Kemet
C20, C21	47 μ F, 50 V Electrolytic Capacitors	476KXM050M	Illinois Capacitor
C22, C23	1.0 pF Chip Capacitors	ATC100B1R0BT500XT	ATC
C24, C25	0.5 pF Chip Capacitors	ATC100B0R5BT500XT	ATC
C30, C31	0.8 pF Chip Capacitors	ATC100B0R8BT500XT	ATC
C36, C37	4.7 pF Chip Capacitors	ATC100B4R7CT500XT	ATC
C38, C39	4.3 pF Chip Capacitors	ATC100B4R3CT500XT	ATC
C40, C41	11 pF Chip Capacitors	ATC100B110JT500XT	ATC
C44, C45	20 pF Chip Capacitors	ATC100B200JT500XT	ATC
C46, C47	30 pF Chip Capacitors	ATC100B300JT500XT	ATC
C48, C49, C50, C51	10 μ F, 50 V Chip Capacitors	GRM55DR61H106KA88L	Murata
C52, C53	470 μ F, 63 V Electrolytic Capacitors	MCGPR63V477M13X26-RH	Multicomp
PCB	0.030", $\epsilon_r = 3.50$	RF-35	Taconic

MRF8P9300HR6 MRF8P9300HSR6

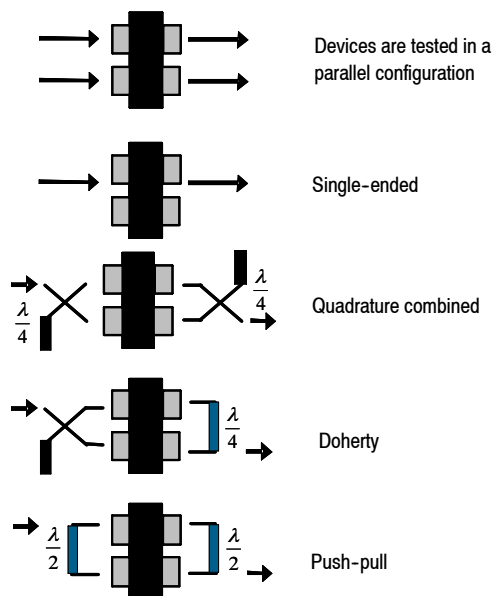

Figure 3. Possible Circuit Topologies

TYPICAL CHARACTERISTICS

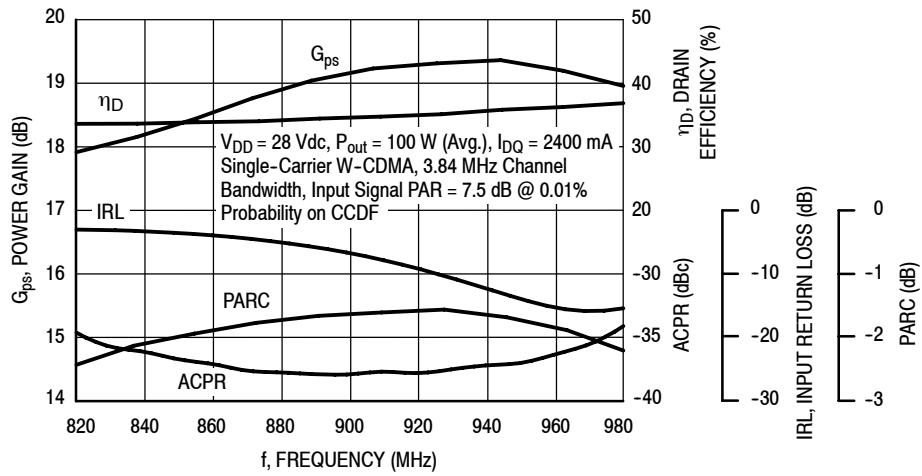

Figure 4. Output Peak-to-Average Ratio Compression (PARC) Broadband Performance @ P_{out} = 100 Watts Avg.

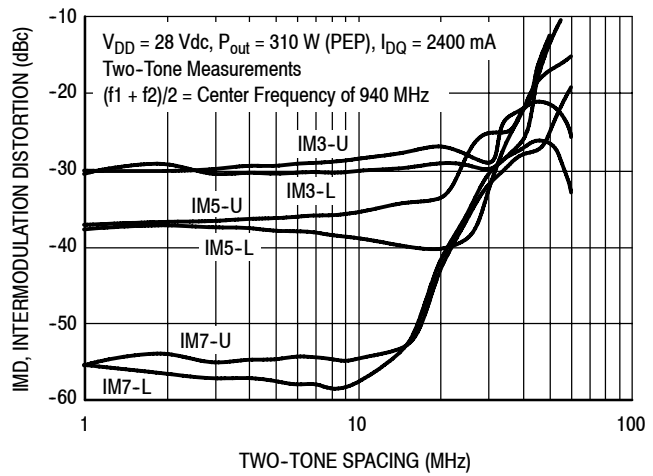

Figure 5. Intermodulation Distortion Products versus Two-Tone Spacing

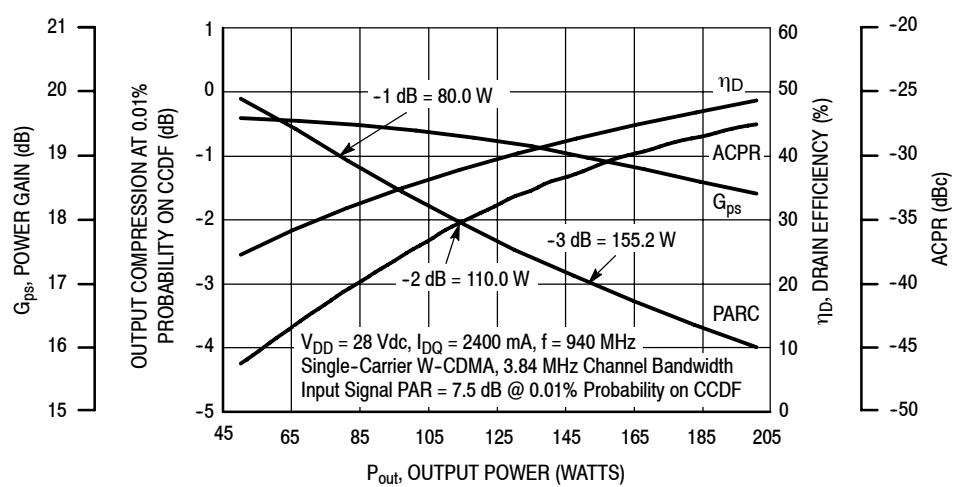

Figure 6. Output Peak-to-Average Ratio Compression (PARC) versus Output Power

TYPICAL CHARACTERISTICS

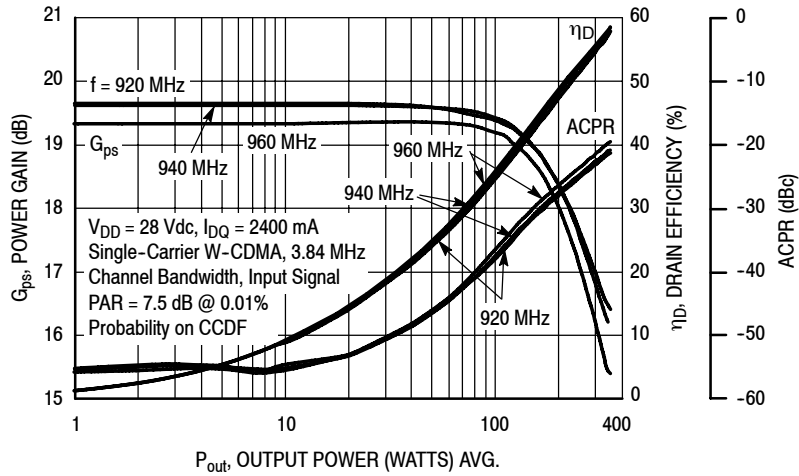

Figure 7. Single-Carrier W-CDMA Power Gain, Drain Efficiency and ACPR versus Output Power

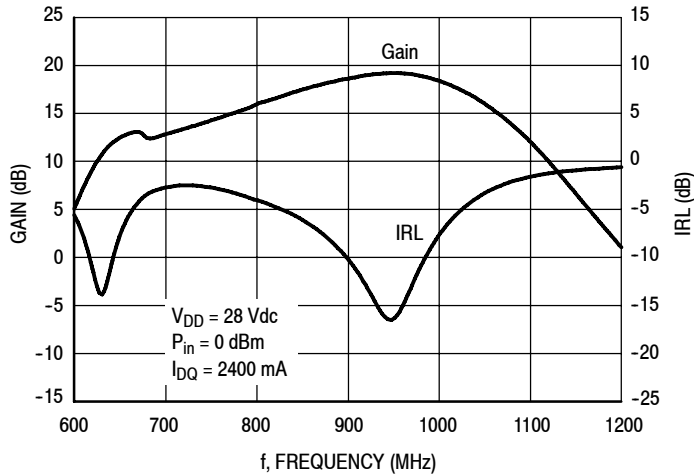

Figure 8. Broadband Frequency Response

W-CDMA TEST SIGNAL

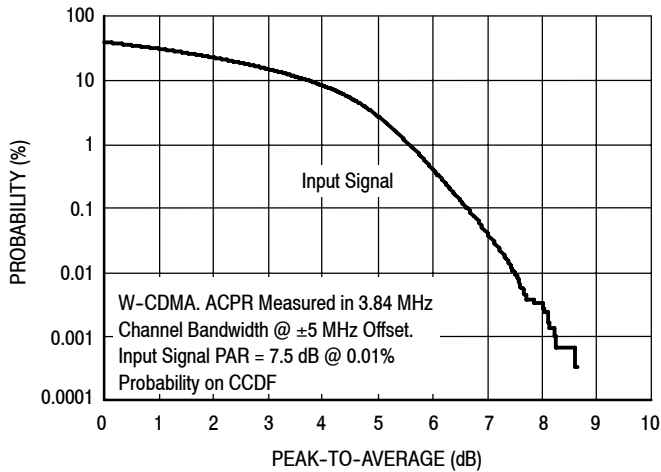

Figure 9. CCDF W-CDMA IQ Magnitude Clipping, Single-Carrier Test Signal

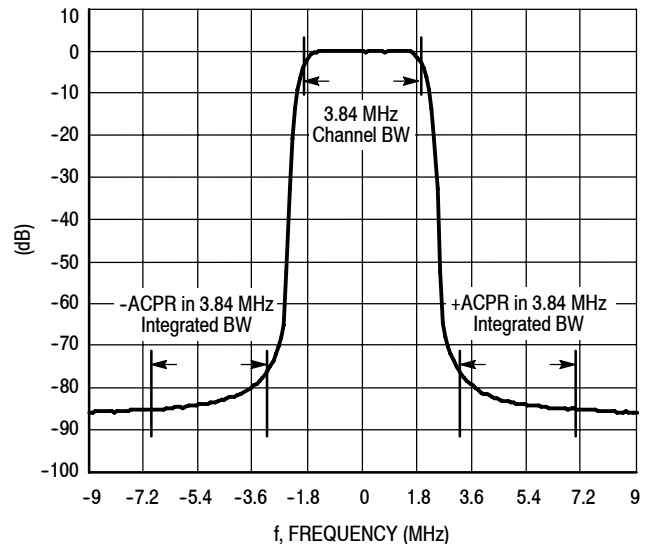

Figure 10. Single-Carrier W-CDMA Spectrum

$V_{DD} = 28 \text{ Vdc}$, $I_{DQA} = I_{DQB} = 1200 \text{ mA}$, $P_{out} = 100 \text{ W Avg.}$

f MHz	Z_{source} Ω	Z_{load} Ω
840	$1.74 - j1.71$	$0.98 - j0.97$
860	$1.74 - j1.42$	$0.95 - j0.95$
880	$1.59 - j1.19$	$0.92 - j0.92$
900	$1.46 - j0.91$	$0.90 - j0.90$
920	$1.51 - j0.63$	$0.87 - j0.87$

Z_{source} = Test circuit impedance as measured from gate to ground.

Z_{load} = Test circuit impedance as measured from drain to ground.

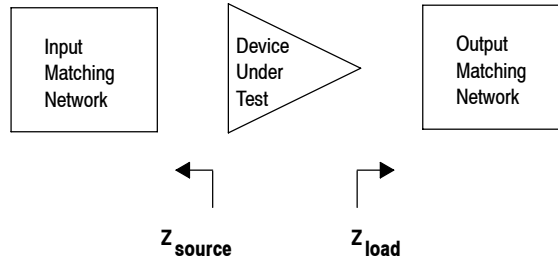
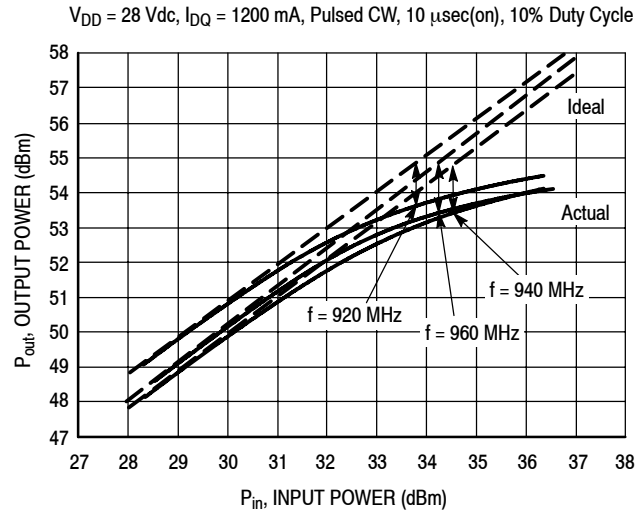

Figure 11. Series Equivalent Source and Load Impedance

ALTERNATIVE PEAK TUNE LOAD PULL CHARACTERISTICS



NOTE: Load Pull Test Fixture Tuned for Peak P1dB Output Power @ 28 V

f (MHz)	P1dB	
	Watts	dBm
920	229	53.6
940	214	53.3
960	219	53.4

Test Impedances per Compression Level

f (MHz)		Z_{source} Ω	Z_{load} Ω
920	P1dB	1.58 - j2.40	0.84 - j1.69
940	P1dB	1.77 - j3.02	0.76 - j1.90
960	P1dB	1.98 - j3.46	0.75 - j1.51

Figure 12. Pulsed CW Output Power versus Input Power @ 28 V

NOTE: Measurement made on a per side basis.

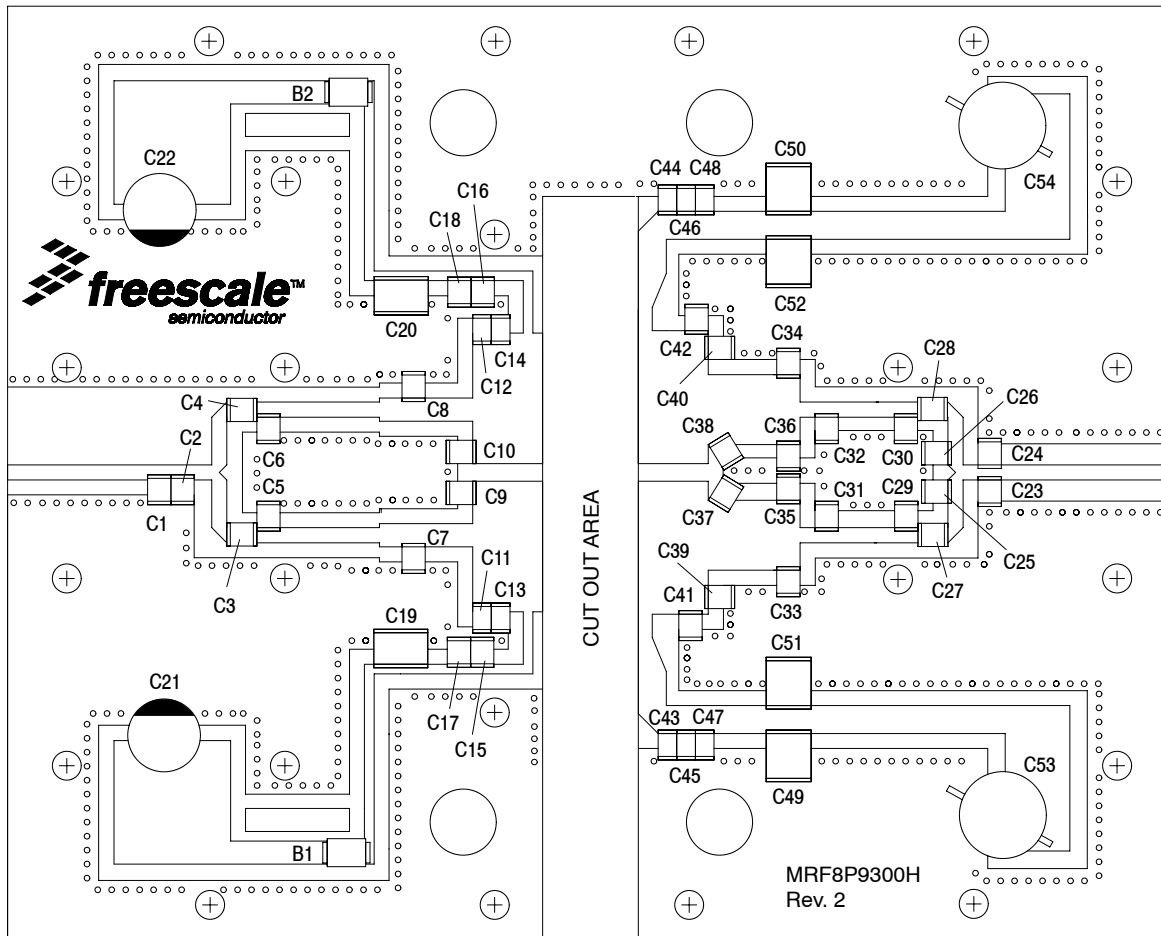

Figure 13. MRF8P9300HR6(HSR6) Test Circuit Component Layout — 865-895 MHz

Table 6. MRF8P9300HR6(HSR6) Test Circuit Component Designations and Values — 865-895 MHz

Part	Description	Part Number	Manufacturer
B1, B2	Short Ferrite bead	2743019447	Fair-Rite
C1	0.2 pF Chip Capacitor	ATC100B0R2CT500XT	ATC
C2	0.3 pF Chip Capacitor	ATC100B0R3CT500XT	ATC
C3, C4, C17, C18, C27, C28	39 pF Chip Capacitors	ATC100B390JT500XT	ATC
C5, C6, C29, C30, C33, C34, C35, C36	1.1 pF Chip Capacitors	ATC100B1R1JP500XT	ATC
C7, C8, C37, C38	4.3 pF Chip Capacitors	ATC100B4R3JP500XT	ATC
C9, C10	7.5 pF Chip Capacitors	ATC100B7R5JP500XT	ATC
C11, C12, C13, C14	3.0 pF Chip Capacitors	ATC100B3R0JP500XT	ATC
C15, C16, C43, C44	10 pF Chip Capacitors	ATC100B100JT500XT	ATC
C19, C20	2.2 μ F, 50 V Chip Capacitors	C1825C225J5RAC	Kemet
C21, C22	47 μ F, 50 V Electrolytic Capacitors	476KXM063M	Illinois Capacitor
C23, C24	1.0 pF Chip Capacitors	ATC100B1R0JP500XT	ATC
C25, C26	0.5 pF Chip Capacitors	ATC100B0R5CT500XT	ATC
C31, C32	0.8 pF Chip Capacitors	ATC100B0R8JP500XT	ATC
C39, C40	4.7 pF Chip Capacitors	ATC100B4R7JP500XT	ATC
C41, C42	11 pF Chip Capacitors	ATC100B110JT500XT	ATC
C45, C46	20 pF Chip Capacitors	ATC100B200JT500XT	ATC
C47, C48	30 pF Chip Capacitors	ATC100B300JT500XT	ATC
C49, C50, C51, C52	10 μ F, 50 V Chip Capacitors	GRM55DR61HT106KA88L	Murata
C53, C54	470 μ F, 63 V Electrolytic Capacitors	KME63VB471M12x25LL	Chemi-Con
PCB	0.030", $\epsilon_r = 3.5$	RF-35	Taconic

TYPICAL CHARACTERISTICS — 865-895 MHz

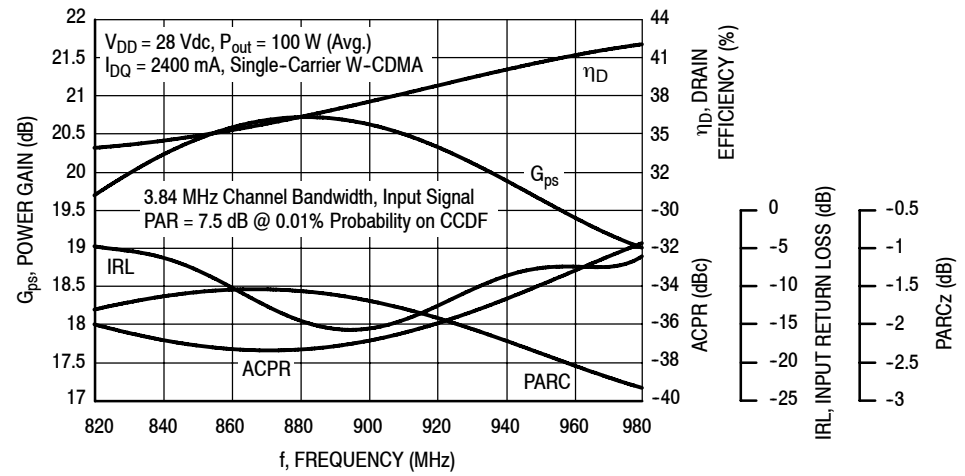

Figure 14. Output Peak-to-Average Ratio Compression (PARC) Broadband Performance @ $P_{out} = 100$ Watts Avg.

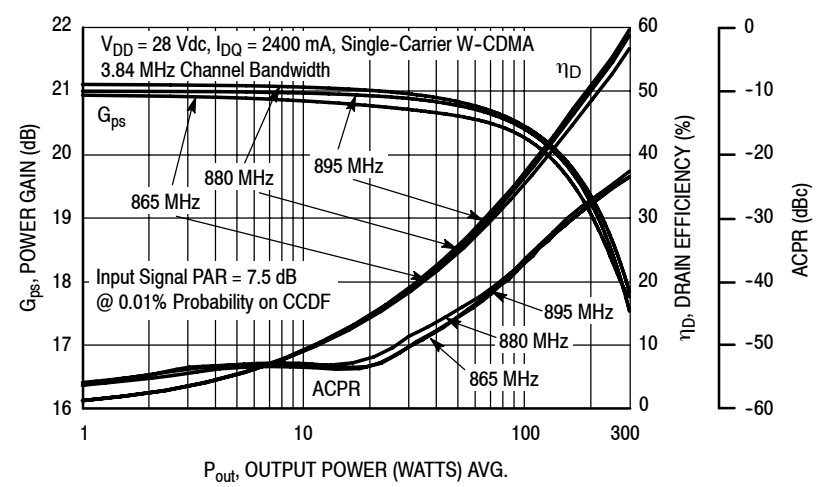

Figure 15. Single-Carrier W-CDMA Power Gain, Drain Efficiency and ACPR versus Output Power

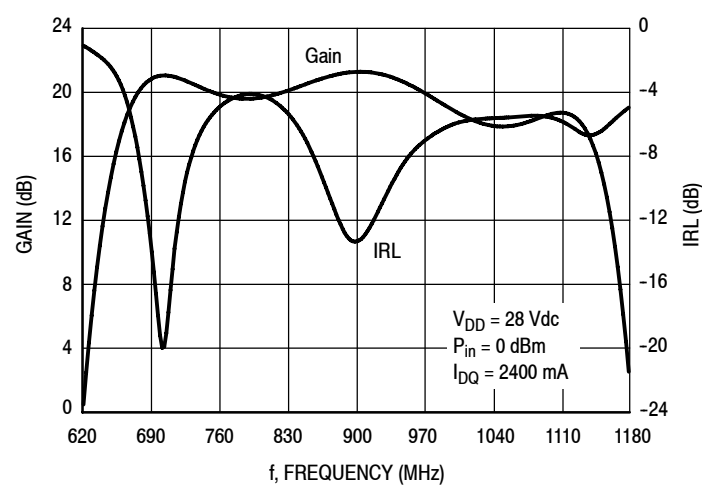

Figure 16. Broadband Frequency Response

$V_{DD} = 28 \text{ Vdc}$, $I_{DQ} = 2400 \text{ mA}$, $P_{out} = 100 \text{ W Avg.}$

f MHz	Z_{source} Ω	Z_{load} Ω
820	$0.45 - j0.78$	$1.72 - j0.73$
840	$0.42 + j0.34$	$1.67 - j0.39$
860	$0.39 + j0.05$	$1.59 - j0.06$
880	$0.40 + j0.05$	$1.44 - j0.17$
900	$0.49 + j0.84$	$1.35 + j0.35$
920	$0.75 + j1.32$	$1.30 + j0.61$
940	$1.58 + j1.77$	$1.32 + 0.93$
960	$2.16 + j0.62$	$1.27 + j1.14$
980	$1.37 + j0.64$	$1.21 + j1.30$

Z_{source} = Test circuit impedance as measured from gate to ground.

Z_{load} = Test circuit impedance as measured from drain to ground.

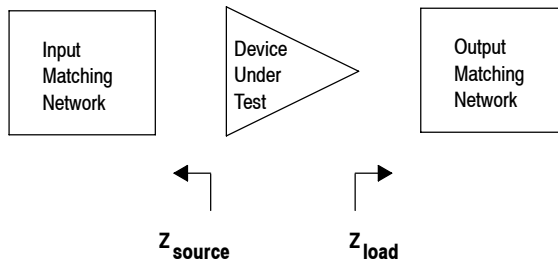
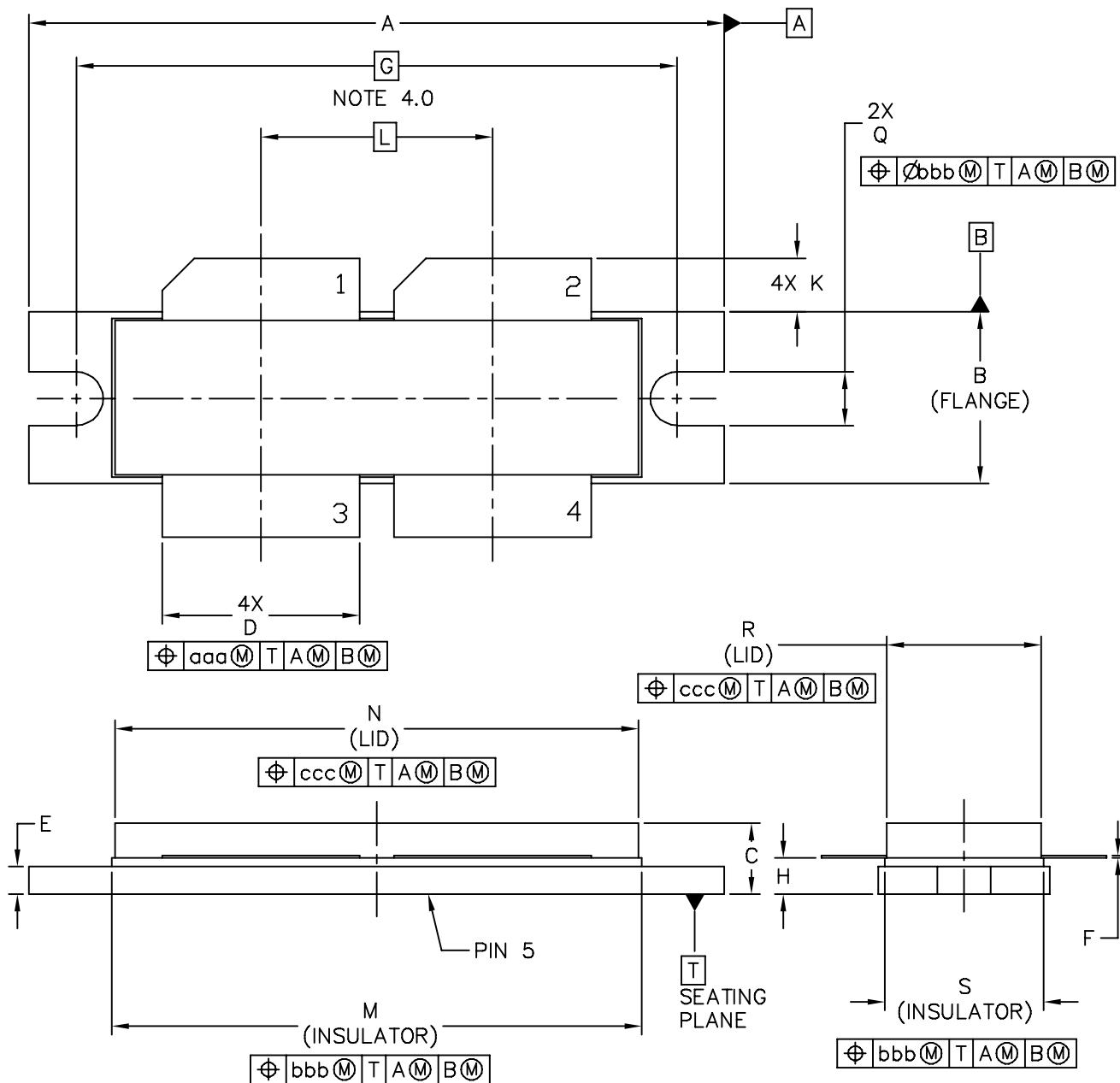

Figure 17. Series Equivalent Source and Load Impedance — 865–895 MHz

PACKAGE DIMENSIONS



© FREESCALE SEMICONDUCTOR, INC. ALL RIGHTS RESERVED.		MECHANICAL OUTLINE		PRINT VERSION NOT TO SCALE	
TITLE: NI-1230		DOCUMENT NO: 98ASB16977C		REV: E	
		CASE NUMBER: 375D-05		31 MAR 2005	
		STANDARD: NON-JEDEC			

NOTES:

- 1.0 INTERPRET DIMENSIONS AND TOLERANCES PER ASME Y14.5M-1994.
- 2.0 CONTROLLING DIMENSION: INCH
- 3.0 DIMENSION H IS MEASURED .030 (0.762) AWAY FROM PACKAGE BODY.
- 4.0 RECOMMENDED BOLT CENTER DIMENSION OF 1.52 (38.61) BASED ON M3 SCREW.

STYLE 1:

- PIN 1 - DRAIN
- 2 - DRAIN
- 3 - GATE
- 4 - GATE
- 5 - SOURCE

DIM	INCH		MILLIMETER		DIM	INCH		MILLIMETER	
	MIN	MAX	MIN	MAX		MIN	MAX	MIN	MAX
A	1.615	1.625	41.02	41.28	N	1.218	1.242	30.94	31.55
B	.395	.405	10.03	10.29	Q	.120	.130	3.05	3.3
C	.150	.200	3.81	5.08	R	.355	.365	9.01	9.27
D	.455	.465	11.56	11.81	S	.365	.375	9.27	9.53
E	.062	.066	1.57	1.68					
F	.004	.007	0.1	0.18					
G	1.400 BSC		35.56 BSC		aaa	.013		0.33	
H	.082	.090	2.08	2.29	bbb	.010		0.25	
K	.117	.137	2.97	3.48	ccc	.020		0.51	
L	.540 BSC		13.72 BSC						
M	1.219	1.241	30.96	31.52					

© FREESCALE SEMICONDUCTOR, INC. ALL RIGHTS RESERVED.		MECHANICAL OUTLINE		PRINT VERSION NOT TO SCALE	
TITLE: NI-1230		DOCUMENT NO: 98ASB16977C		REV: E	
		CASE NUMBER: 375D-05		31 MAR 2005	
		STANDARD: NON-JEDEC			

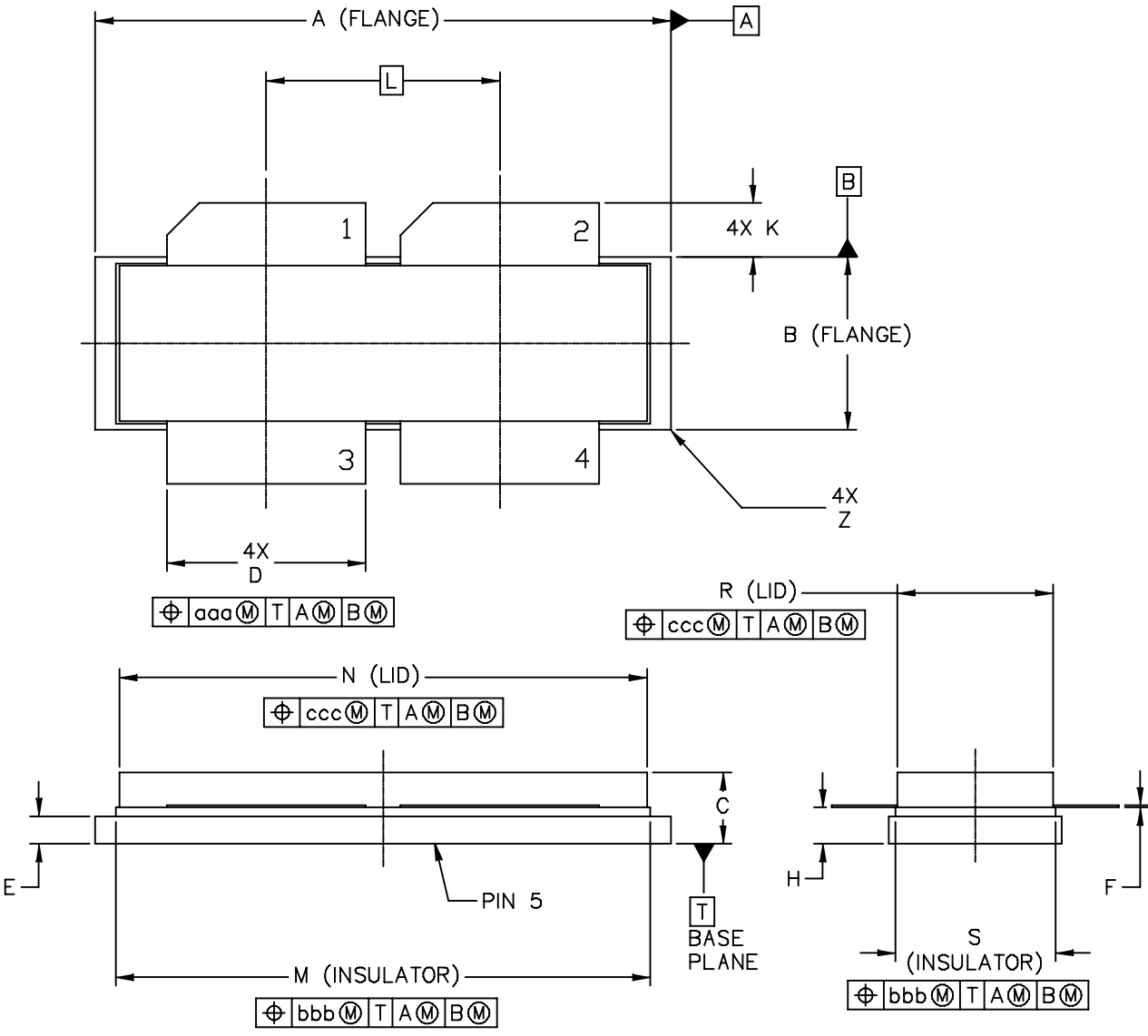

© FREESCALE SEMICONDUCTOR, INC. ALL RIGHTS RESERVED.		MECHANICAL OUTLINE		PRINT VERSION NOT TO SCALE	
TITLE: NI-1230S		DOCUMENT NO: 98ARB18247C		REV: F	
		CASE NUMBER: 375E-04		05 AUG 2005	
		STANDARD: NON-JEDEC			

NOTES:

1. INTERPRET DIMENSIONS AND TOLERANCES PER ASME Y14.5M-1994.
2. CONTROLLING DIMENSION: INCH
3. DIMENSION H IS MEASURED .030 AWAY FROM PACKAGE BODY

STYLE 1:

- PIN 1 - DRAIN
- 2 - DRAIN
- 3 - GATE
- 4 - GATE
- 5 - SOURCE

DIM	INCHES		MILLIMETERS		DIM	INCHES		MILLIMETERS	
	MIN	MAX	MIN	MAX		MIN	MAX	MIN	MAX
A	1.265	1.275	32.13	32.38	R	.355	.365	9.01	9.27
B	.395	.405	10.03	10.29	S	.365	.375	9.27	9.53
C	.150	.200	3.81	5.08	Z	---	.040	---	1.02
D	.455	.465	11.56	11.81					
E	.062	.066	1.57	1.68	aaa	.013		0.33	
F	.004	.007	0.1	0.18	bbb	.010		0.25	
H	.082	.090	2.08	2.29	ccc	.020		0.51	
K	.117	.137	2.97	3.48					
L	.540 BSC		13.72 BSC						
M	1.219	1.241	30.96	31.52					
N	1.218	1.242	30.94	31.55					
© FREESCALE SEMICONDUCTOR, INC. ALL RIGHTS RESERVED.			MECHANICAL OUTLINE			PRINT VERSION NOT TO SCALE			
TITLE: NI-1230S					DOCUMENT NO: 98ARB18247C			REV: F	
					CASE NUMBER: 375E-04			05 AUG 2005	
					STANDARD: NON-JEDEC				

Refer to the following documents to aid your design process.

Application Notes

- AN1955: Thermal Measurement Methodology of RF Power Amplifiers

Engineering Bulletins

- EB212: Using Data Sheet Impedances for RF LDMOS Devices

Software

- Electromigration MTTF Calculator
- RF High Power Model
- .s2p File

For Software, do a Part Number search at <http://www.freescale.com>, and select the “Part Number” link. Go to the Software & Tools tab on the part’s Product Summary page to download the respective tool.

REVISION HISTORY

The following table summarizes revisions to this document.

Revision	Date	Description
0	Nov. 2009	<ul style="list-style-type: none"> • Initial Release of Data Sheet
1	May 2010	<ul style="list-style-type: none"> • Changed ESD Human Body Model rating from Class 1C to Class 2 to reflect recent ESD test results of the device, p. 2 • Added Alternate Characterization for 865–895 MHz Frequency Band as follows: <ul style="list-style-type: none"> - Typical Performance bullet, p. 1 - Typical Broadband Performance table, p. 3 - Fig. 13, Test Circuit Component Layout and Table 6, Test Circuit Component Designations and Values, p. 10 - Fig. 14, Output Peak-to-Average Ratio Compression (PARC) Broadband Performance @ P_{out} = 100 Watts Avg., p. 11 - Fig. 15, Single-Carrier W-CDMA Power Gain, Drain, Efficiency and ACPR versus Output Power, p. 11 - Fig. 16, Broadband Frequency Response, p. 11 - Fig. 17, Series Equivalent Source and Load Impedance, p. 12
1.1	July 2010	<ul style="list-style-type: none"> • Changed 850 MHz to 880 MHz in the Typical Broadband Performance table for the 865–895 MHz frequency band, p. 3 • Added connection pad identifiers to Fig. 2, Test Circuit Component Layout, p. 4

How to Reach Us:

Home Page:

www.freescale.com

Web Support:

<http://www.freescale.com/support>

USA/Europe or Locations Not Listed:

Freescale Semiconductor, Inc.
Technical Information Center, EL516
2100 East Elliot Road
Tempe, Arizona 85284
1-800-521-6274 or +1-480-768-2130
www.freescale.com/support

Europe, Middle East, and Africa:

Freescale Halbleiter Deutschland GmbH
Technical Information Center
Schatzbogen 7
81829 Muenchen, Germany
+44 1296 380 456 (English)
+46 8 52200080 (English)
+49 89 92103 559 (German)
+33 1 69 35 48 48 (French)
www.freescale.com/support

Japan:

Freescale Semiconductor Japan Ltd.
Headquarters
ARCO Tower 15F
1-8-1, Shimo-Meguro, Meguro-ku,
Tokyo 153-0064
Japan
0120 191014 or +81 3 5437 9125
support.japan@freescale.com

Asia/Pacific:

Freescale Semiconductor China Ltd.
Exchange Building 23F
No. 118 Jianguo Road
Chaoyang District
Beijing 100022
China
+86 10 5879 8000
support.asia@freescale.com

For Literature Requests Only:

Freescale Semiconductor Literature Distribution Center
1-800-441-2447 or +1-303-675-2140
Fax: +1-303-675-2150
LDCForFreescaleSemiconductor@hibbertgroup.com

Information in this document is provided solely to enable system and software implementers to use Freescale Semiconductor products. There are no express or implied copyright licenses granted hereunder to design or fabricate any integrated circuits or integrated circuits based on the information in this document.

Freescale Semiconductor reserves the right to make changes without further notice to any products herein. Freescale Semiconductor makes no warranty, representation or guarantee regarding the suitability of its products for any particular purpose, nor does Freescale Semiconductor assume any liability arising out of the application or use of any product or circuit, and specifically disclaims any and all liability, including without limitation consequential or incidental damages. "Typical" parameters that may be provided in Freescale Semiconductor data sheets and/or specifications can and do vary in different applications and actual performance may vary over time. All operating parameters, including "Typicals", must be validated for each customer application by customer's technical experts. Freescale Semiconductor does not convey any license under its patent rights nor the rights of others. Freescale Semiconductor products are not designed, intended, or authorized for use as components in systems intended for surgical implant into the body, or other applications intended to support or sustain life, or for any other application in which the failure of the Freescale Semiconductor product could create a situation where personal injury or death may occur. Should Buyer purchase or use Freescale Semiconductor products for any such unintended or unauthorized application, Buyer shall indemnify and hold Freescale Semiconductor and its officers, employees, subsidiaries, affiliates, and distributors harmless against all claims, costs, damages, and expenses, and reasonable attorney fees arising out of, directly or indirectly, any claim of personal injury or death associated with such unintended or unauthorized use, even if such claim alleges that Freescale Semiconductor was negligent regarding the design or manufacture of the part.

Freescale™ and the Freescale logo are trademarks of Freescale Semiconductor, Inc. All other product or service names are the property of their respective owners.

© Freescale Semiconductor, Inc. 2009-2010. All rights reserved.