

## Complementary 30-V (D-S) MOSFET

PRODUCT SUMMARY			
	V <sub>DS</sub> (V)	R <sub>DS(on)</sub> (Ω)	I <sub>D</sub> (A)
P-Channel	- 30	0.051 at V <sub>GS</sub> = - 10 V	- 6.4
		0.075 at V <sub>GS</sub> = - 6 V	- 5.3
N-Channel	30	0.035 at V <sub>GS</sub> = 10 V	7.7
		0.050 at V <sub>GS</sub> = 4.5 V	6.5

### FEATURES

- Halogen-free Option Available
- TrenchFET<sup>®</sup> Power MOSFET
- New Low Thermal Resistance
- PowerPAK<sup>®</sup> Package with Low 1.07 mm Profile



**RoHS**  
COMPLIANT

### APPLICATIONS

- Backlight Inverter
- DC/DC Converter  
- 4 Cell Battery

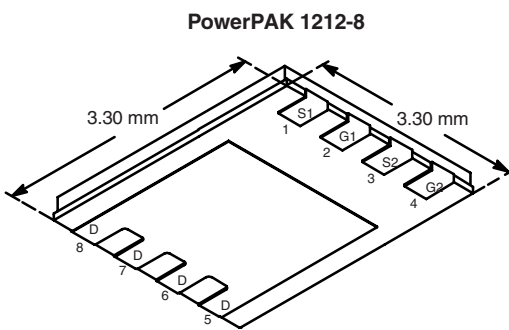

Bottom View

Ordering Information: Si7501DN-T1-E3 (Lead (Pb)-free)  
Si7501DN-T1-GE3 (Lead (Pb)-free and Halogen-free)

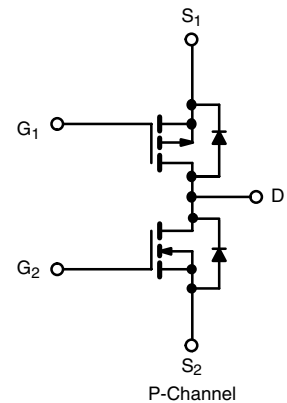

ABSOLUTE MAXIMUM RATINGS T <sub>A</sub> = 25 °C, unless otherwise noted							
Parameter	Symbol	P-Channel		N-Channel		Unit	
		10 s	Steady State	10 s	Steady State		
Drain-Source Voltage	V <sub>DS</sub>	- 30		30		V	
Gate-Source Voltage	V <sub>GS</sub>	± 25		± 20			
Continuous Drain Current (T <sub>J</sub> = 150 °C) <sup>a</sup>	I <sub>D</sub>	T <sub>A</sub> = 25 °C	- 6.4	- 4.5	7.7	5.4	A
		T <sub>A</sub> = 70 °C	- 5.1	- 3.6	4.7	4.3	
Pulsed Drain Current	I <sub>DM</sub>	- 25		25		W	
Continuous Source Current (Diode Conduction) <sup>a</sup>	I <sub>S</sub>	- 2.6	- 1.3	2.6	1.3		
Maximum Power Dissipation <sup>a</sup>	P <sub>D</sub>	T <sub>A</sub> = 25 °C	3.1	1.6	3.1	1.6	W
		T <sub>A</sub> = 70 °C	3	1.0	2	1.0	
Operating Junction and Storage Temperature Range	T <sub>J</sub> , T <sub>stg</sub>	- 55 to 150				°C	
Soldering Recommendations (Peak Temperature) <sup>b, c</sup>		260					

THERMAL RESISTANCE RATINGS					
Parameter		Symbol	Typical	Maximum	Unit
Maximum Junction-to-Ambient <sup>a</sup>	t ≤ 10 s	R <sub>thJA</sub>	32	40	°C/W
	Steady State		65	81	
Maximum Junction-to-Foot (Case)	Steady State	R <sub>thJC</sub>	5	6.3	

Notes:

a. Surface Mounted on 1" x 1" FR4 board.

b. See Solder Profile (<http://www.vishay.com/ppg?73257>). The PowerPAK 1212-8 is a leadless package. The end of the lead terminal is exposed copper (not plated) as a result of the singulation process in manufacturing. A solder fillet at the exposed copper tip cannot be guaranteed and is not required to ensure adequate bottom side solder interconnection.

c. Rework Conditions: manual soldering with a soldering iron is not recommended for leadless components.

<b>SPECIFICATIONS</b> $T_J = 25\text{ }^\circ\text{C}$ , unless otherwise noted							
Parameter	Symbol	Test Conditions	Min.	Typ.	Max.	Unit	
<b>Static</b>							
Gate Threshold Voltage	$V_{GS(th)}$	$V_{DS} = V_{GS}, I_D = -250\text{ }\mu\text{A}$	P-Ch	-1.0		-3	V
		$V_{DS} = V_{GS}, I_D = 250\text{ }\mu\text{A}$	N-Ch	1.0		3	
Gate-Body Leakage	$I_{GSS}$	$V_{DS} = 0\text{ V}, V_{GS} = \pm 25\text{ V}$	P-Ch			$\pm 200$	nA
		$V_{DS} = 0\text{ V}, V_{GS} = \pm 20\text{ V}$	N-Ch			$\pm 100$	
Zero Gate Voltage Drain Current	$I_{DSS}$	$V_{DS} = -30\text{ V}, V_{GS} = 0\text{ V}$	P-Ch			-1	$\mu\text{A}$
		$V_{DS} = 30\text{ V}, V_{GS} = 0\text{ V}$	N-Ch			1	
		$V_{DS} = -30\text{ V}, V_{GS} = 0\text{ V}, T_J = 55\text{ }^\circ\text{C}$	P-Ch			-5	
		$V_{DS} = 30\text{ V}, V_{GS} = 0\text{ V}, T_J = 55\text{ }^\circ\text{C}$	N-Ch			5	
On-State Drain Current <sup>a</sup>	$I_{D(on)}$	$V_{DS} \geq -5\text{ V}, V_{GS} = -10\text{ V}$	P-Ch	-25			A
		$V_{DS} \leq 5\text{ V}, V_{GS} = 10\text{ V}$	N-Ch	25			
Drain-Source On-State Resistance <sup>a</sup>	$R_{DS(on)}$	$V_{GS} = -10\text{ V}, I_D = -6.4\text{ A}$	P-Ch		0.041	0.051	$\Omega$
		$V_{GS} = 10\text{ V}, I_D = 7.7\text{ A}$	N-Ch		0.028	0.035	
		$V_{GS} = -6\text{ V}, I_D = -5.3\text{ A}$	P-Ch		0.055	0.075	
		$V_{GS} = 4.5\text{ V}, I_D = 6.5\text{ A}$	N-Ch		0.040	0.050	
Forward Transconductance <sup>a</sup>	$g_{fs}$	$V_{DS} = -15\text{ V}, I_D = -6.4\text{ A}$	P-Ch		13		S
		$V_{DS} = 15\text{ V}, I_D = 7.7\text{ A}$	N-Ch		15		
Diode Forward Voltage <sup>a</sup>	$V_{SD}$	$I_S = -1.7\text{ A}, V_{GS} = 0\text{ V}$	P-Ch		-0.80	-1.2	V
		$I_S = 1.7\text{ A}, V_{GS} = 0\text{ V}$	N-Ch		0.80	1.2	
<b>Dynamic<sup>b</sup></b>							
Total Gate Charge	$Q_g$	P-Channel $V_{DS} = -15\text{ V}, V_{GS} = -10\text{ V}, I_D = -6.4\text{ A}$	P-Ch		12.5	19	nC
Gate-Source Charge	$Q_{gs}$		N-Ch		9	14	
Gate-Drain Charge	$Q_{gd}$	N-Channel $V_{DS} = 15\text{ V}, V_{GS} = 10\text{ V}, I_D = 7.7\text{ A}$	P-Ch		2.5		
			N-Ch		2		
Gate Resistance	$R_g$		P-Ch		9		$\Omega$
			N-Ch		3		
Turn-On Delay Time	$t_{d(on)}$	P-Channel $V_{DD} = -15\text{ V}, R_L = 5\text{ }\Omega$ $I_D \cong -3\text{ A}, V_{GEN} = -10\text{ V}, R_G = 1\text{ }\Omega$	P-Ch		10	15	ns
Rise Time	$t_r$		N-Ch		10	15	
		P-Ch		20	30		
Turn-Off Delay Time	$t_{d(off)}$	N-Channel $V_{DD} = 15\text{ V}, R_L = 5\text{ }\Omega$ $I_D \cong 3\text{ A}, V_{GEN} = 10\text{ V}, R_G = 1\text{ }\Omega$	N-Ch		15	25	
			P-Ch		25	40	
Fall Time	$t_f$		N-Ch		20	30	
			P-Ch		30	45	
Source-Drain Reverse Recovery Time	$t_{rr}$		P-Ch		25	50	
			N-Ch		20	40	

## Notes:

- a. Pulse test; pulse width  $\leq 300\text{ }\mu\text{s}$ , duty cycle  $\leq 2\%$ .  
b. Guaranteed by design, not subject to production testing.

Stresses beyond those listed under "Absolute Maximum Ratings" may cause permanent damage to the device. These are stress ratings only, and functional operation of the device at these or any other conditions beyond those indicated in the operational sections of the specifications is not implied. Exposure to absolute maximum rating conditions for extended periods may affect device reliability.

**P-CHANNEL TYPICAL CHARACTERISTICS** 25 °C, unless otherwise noted

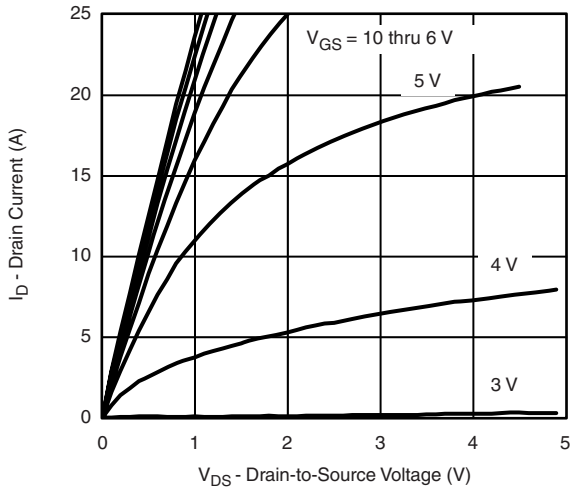

**Output Characteristics**

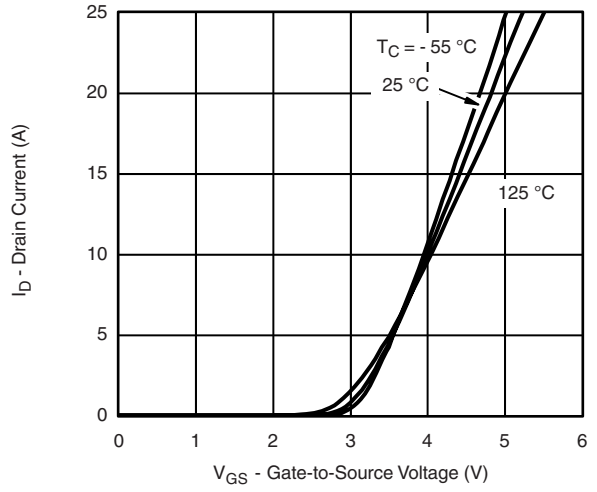

**Transfer Characteristics**

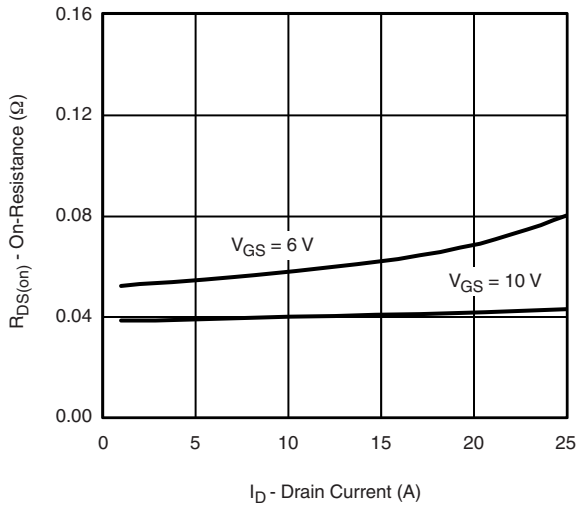

**On-Resistance vs. Drain Current**

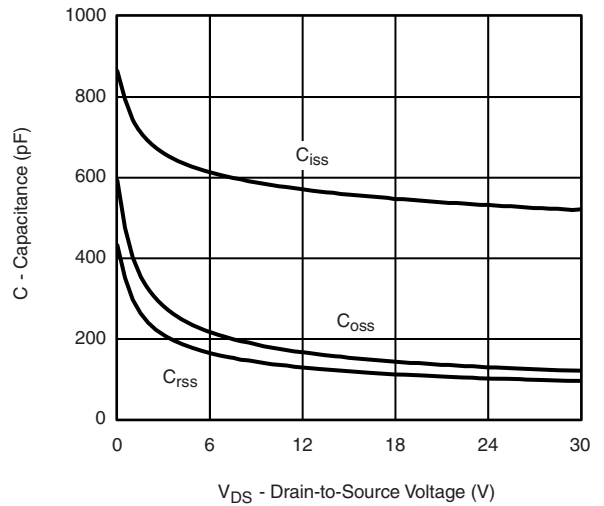

**Capacitance**

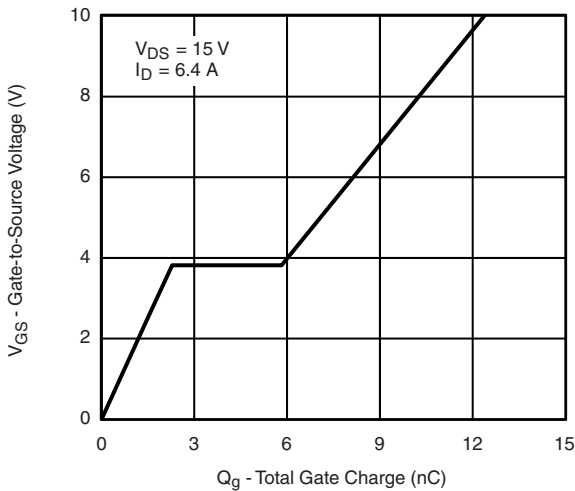

**Gate Charge**

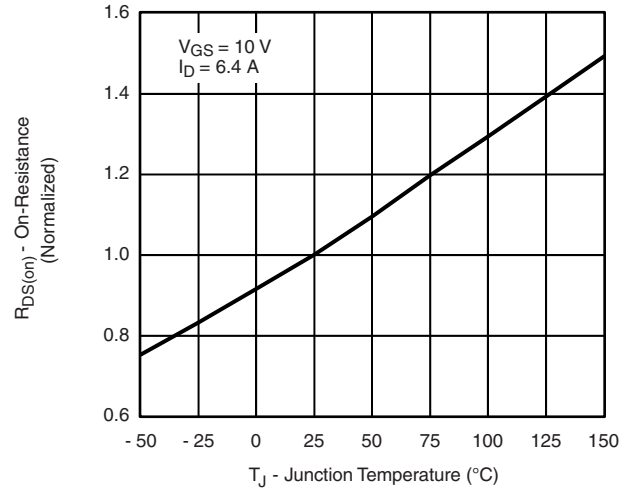

**On-Resistance vs. Junction Temperature**

## P-CHANNEL TYPICAL CHARACTERISTICS 25 °C, unless otherwise noted

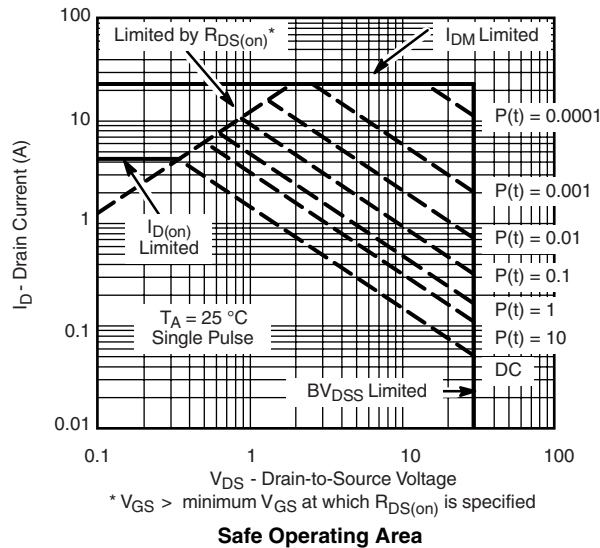
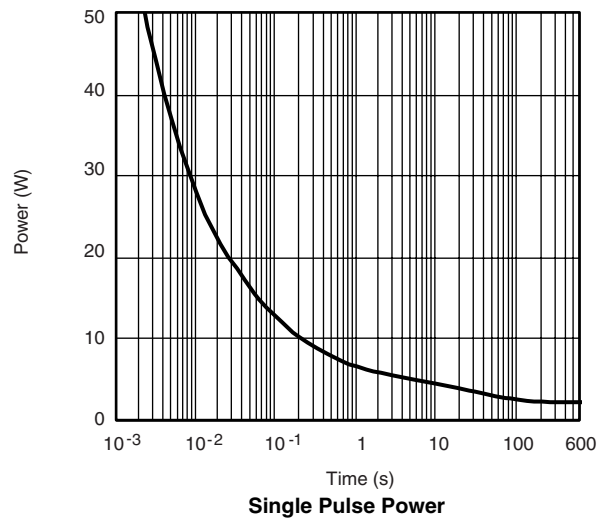
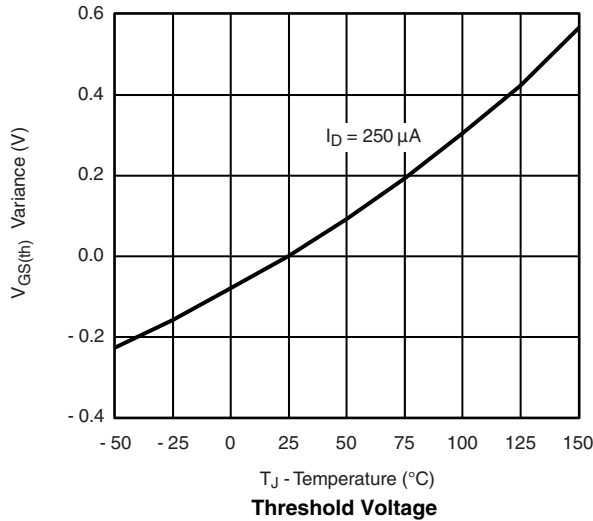
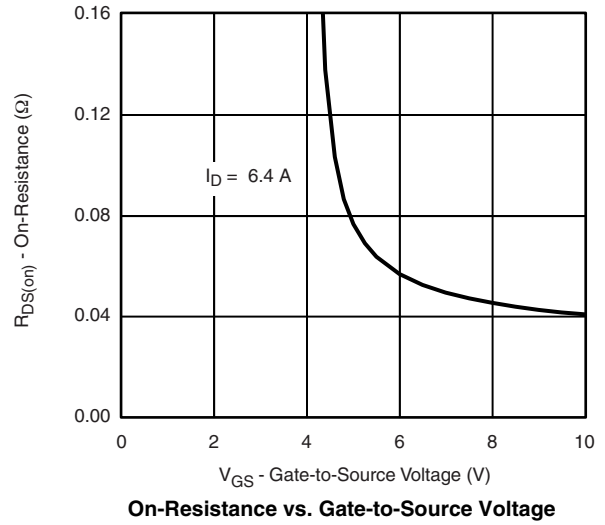
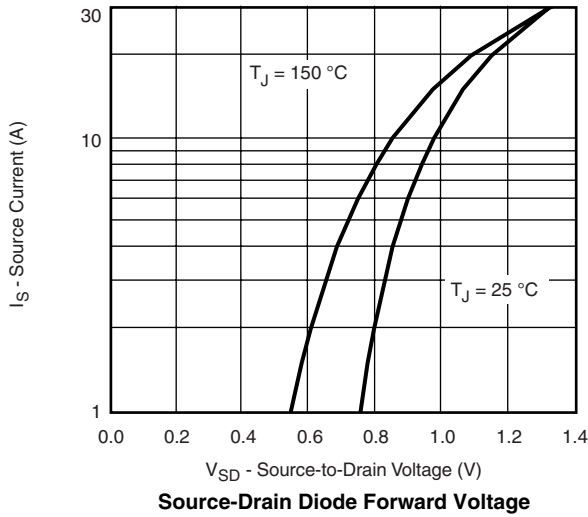

**P-CHANNEL TYPICAL CHARACTERISTICS** 25 °C, unless otherwise noted

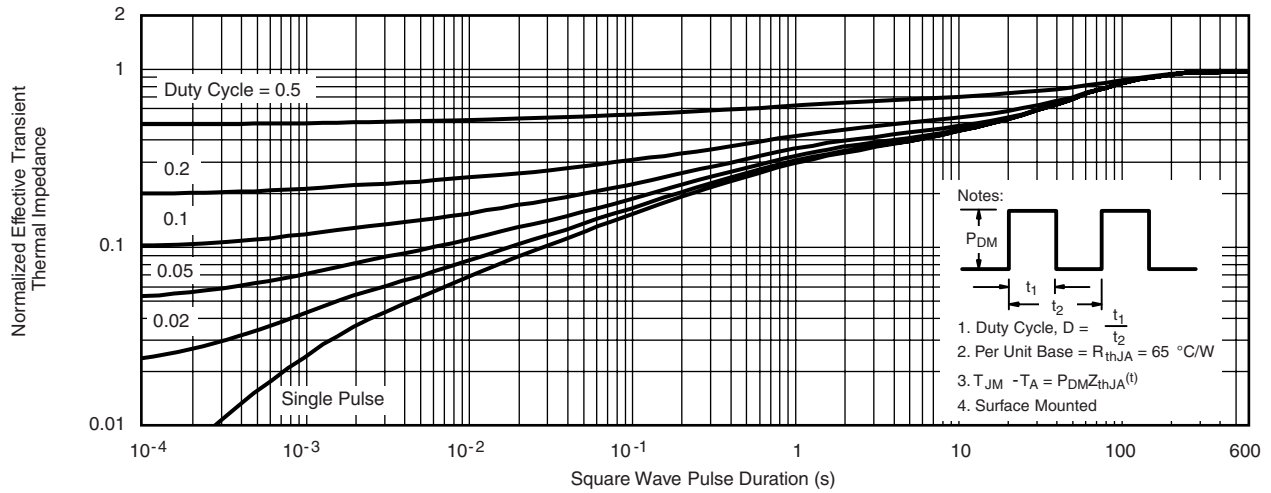

**Normalized Thermal Transient Impedance, Junction-to-Ambient**

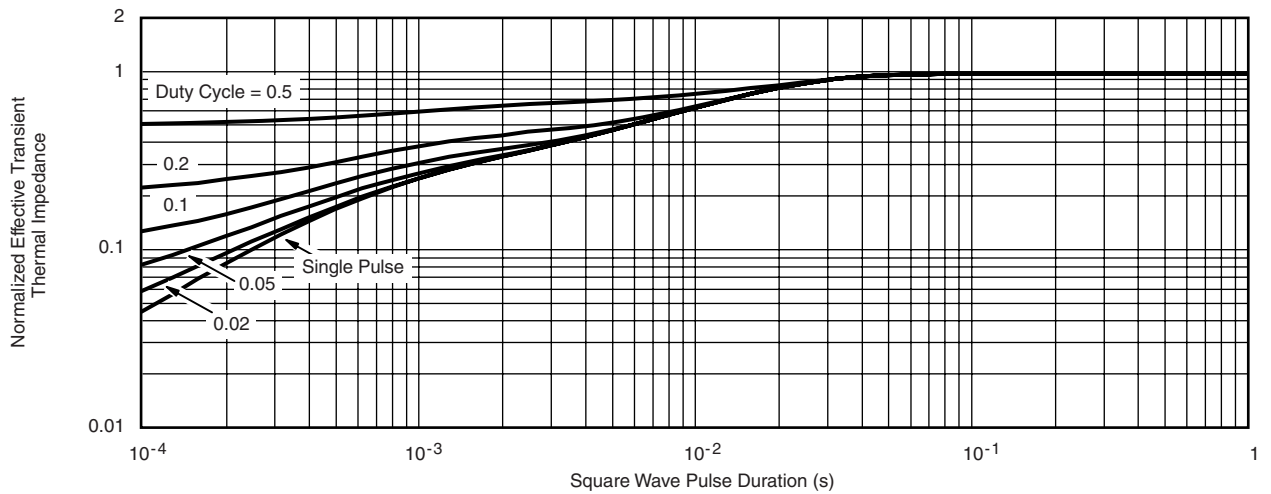

**Normalized Thermal Transient Impedance, Junction-to-Case**

## N-CHANNEL TYPICAL CHARACTERISTICS 25 °C, unless otherwise noted

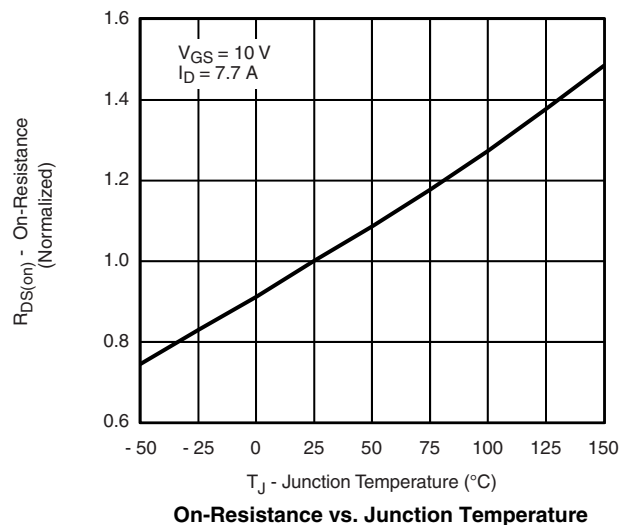
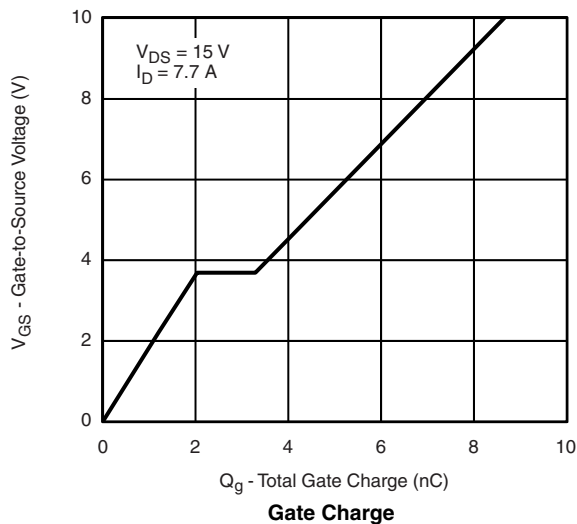
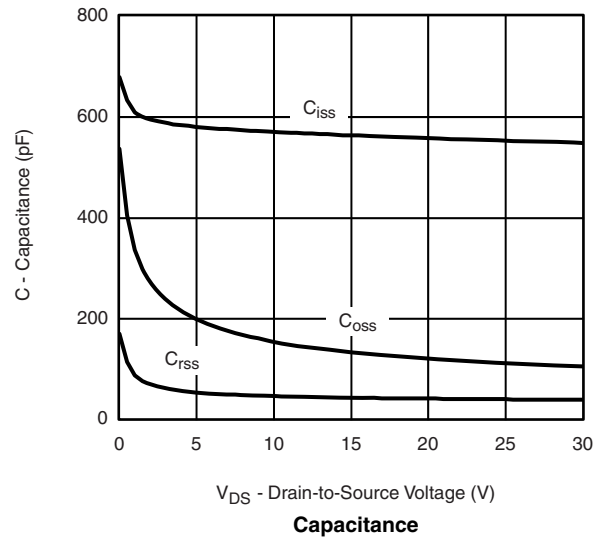
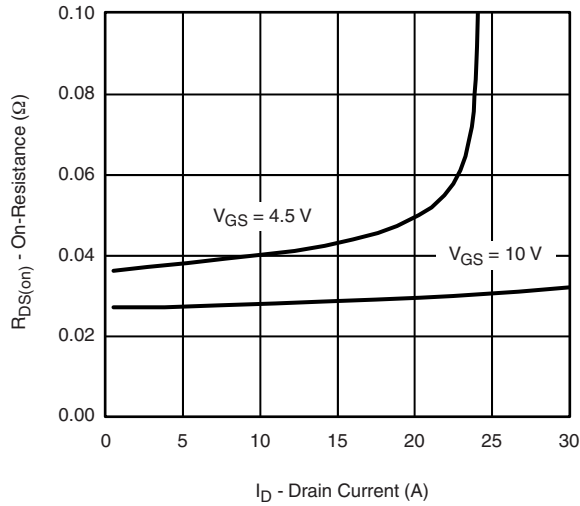
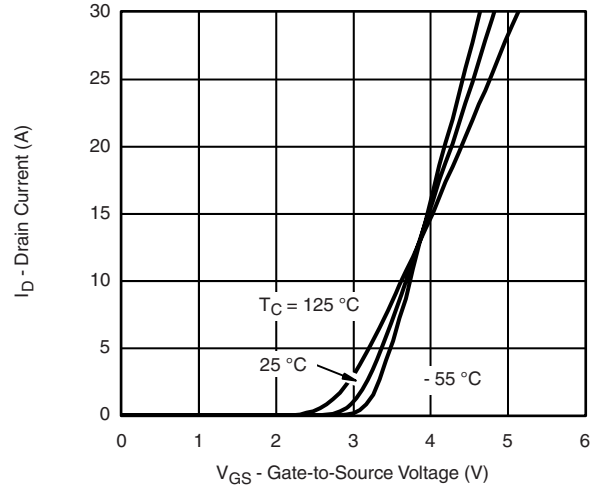
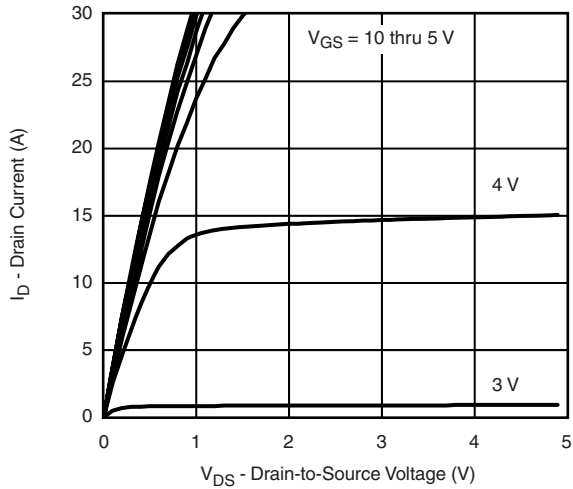

**N-CHANNEL TYPICAL CHARACTERISTICS** 25 °C, unless otherwise noted

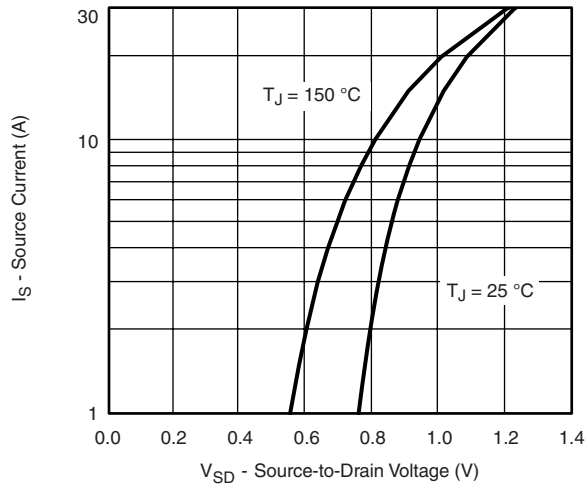

**Source-Drain Diode Forward Voltage**

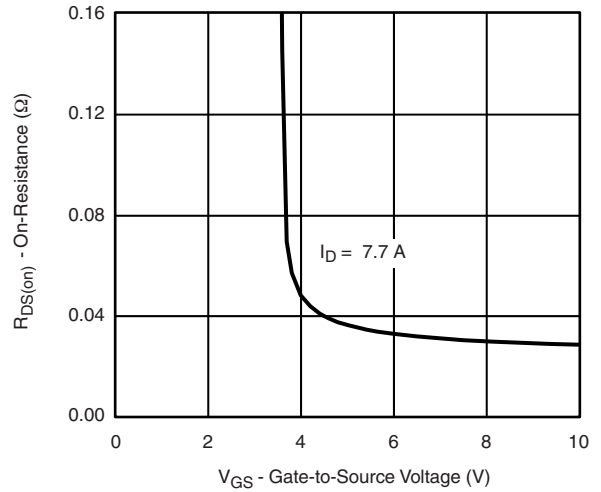

**On-Resistance vs. Gate-to-Source Voltage**

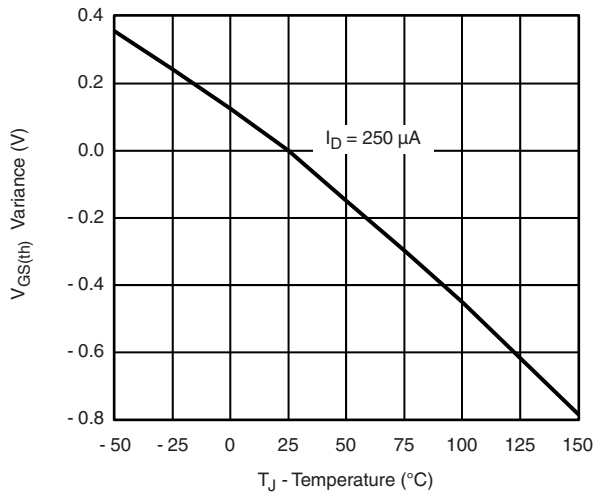

**Threshold Voltage**

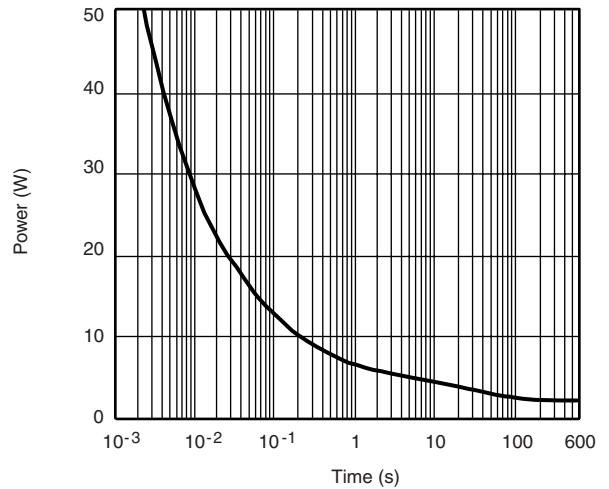

**Single Pulse Power**

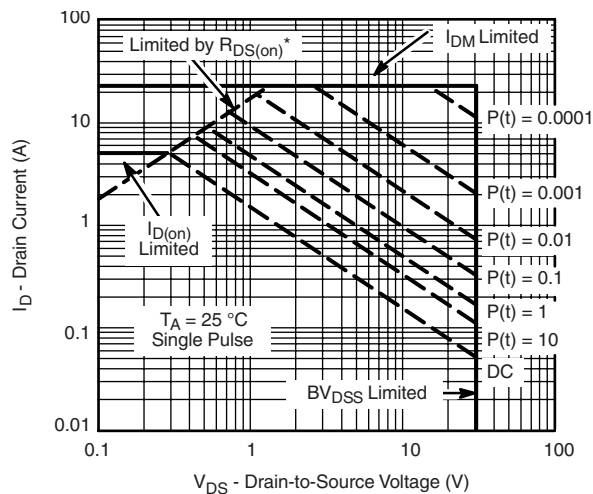

**Safe Operating Area**

## N-CHANNEL TYPICAL CHARACTERISTICS 25 °C, unless otherwise noted

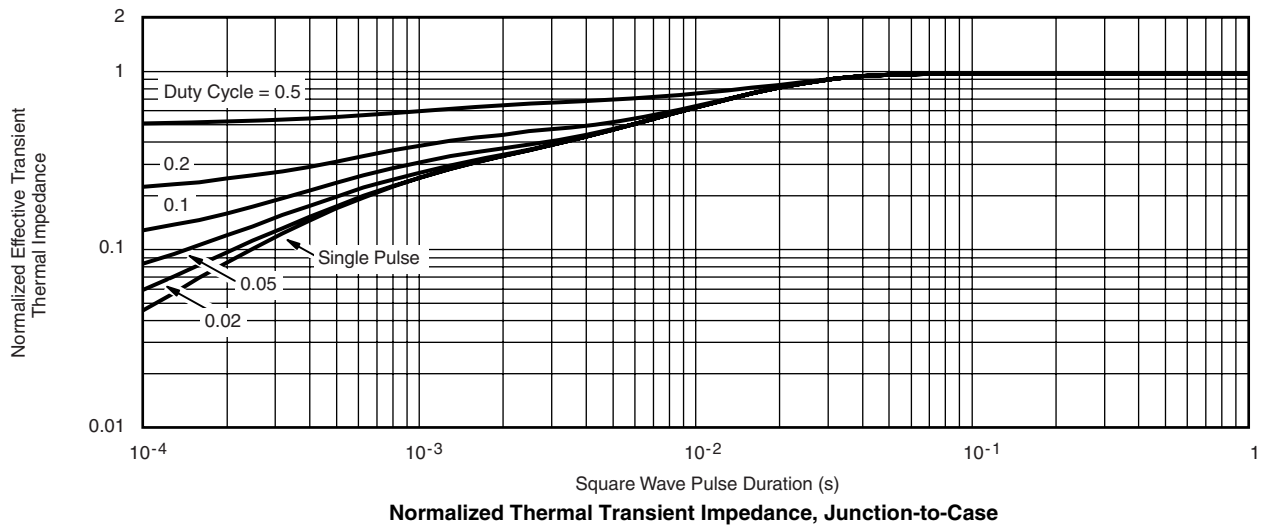
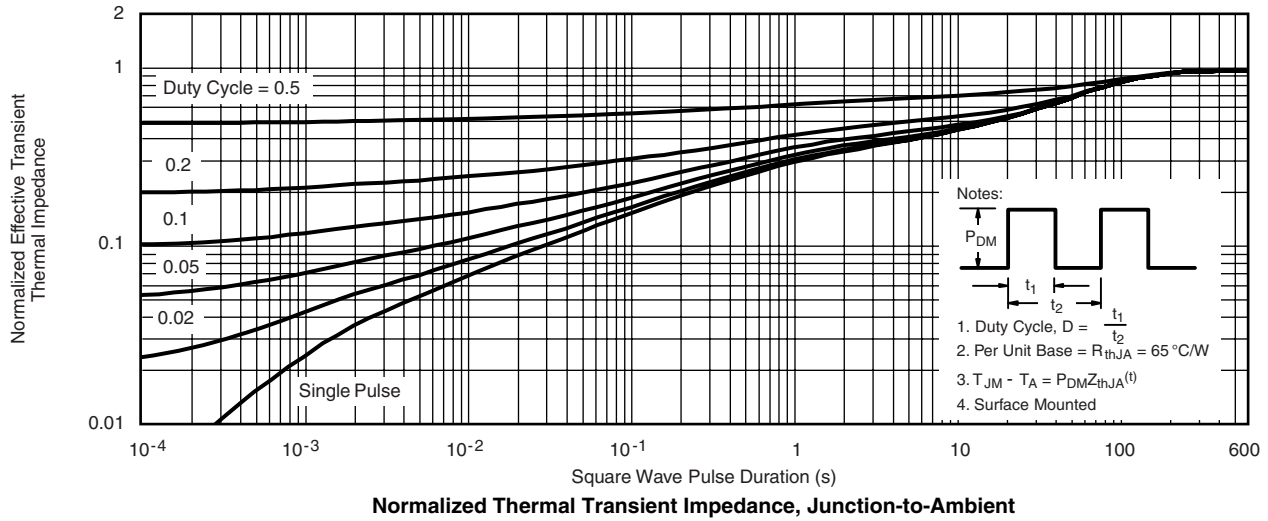

Vishay Siliconix maintains worldwide manufacturing capability. Products may be manufactured at one of several qualified locations. Reliability data for Silicon Technology and Package Reliability represent a composite of all qualified locations. For related documents such as package/tape drawings, part marking, and reliability data, see <http://www.vishay.com/ppg?72173>.





## **Disclaimer**

ALL PRODUCT, PRODUCT SPECIFICATIONS AND DATA ARE SUBJECT TO CHANGE WITHOUT NOTICE TO IMPROVE RELIABILITY, FUNCTION OR DESIGN OR OTHERWISE.

Vishay Intertechnology, Inc., its affiliates, agents, and employees, and all persons acting on its or their behalf (collectively, "Vishay"), disclaim any and all liability for any errors, inaccuracies or incompleteness contained in any datasheet or in any other disclosure relating to any product.

Vishay makes no warranty, representation or guarantee regarding the suitability of the products for any particular purpose or the continuing production of any product. To the maximum extent permitted by applicable law, Vishay disclaims (i) any and all liability arising out of the application or use of any product, (ii) any and all liability, including without limitation special, consequential or incidental damages, and (iii) any and all implied warranties, including warranties of fitness for particular purpose, non-infringement and merchantability.

Statements regarding the suitability of products for certain types of applications are based on Vishay's knowledge of typical requirements that are often placed on Vishay products in generic applications. Such statements are not binding statements about the suitability of products for a particular application. It is the customer's responsibility to validate that a particular product with the properties described in the product specification is suitable for use in a particular application. Parameters provided in datasheets and / or specifications may vary in different applications and performance may vary over time. All operating parameters, including typical parameters, must be validated for each customer application by the customer's technical experts. Product specifications do not expand or otherwise modify Vishay's terms and conditions of purchase, including but not limited to the warranty expressed therein.

Hyperlinks included in this datasheet may direct users to third-party websites. These links are provided as a convenience and for informational purposes only. Inclusion of these hyperlinks does not constitute an endorsement or an approval by Vishay of any of the products, services or opinions of the corporation, organization or individual associated with the third-party website. Vishay disclaims any and all liability and bears no responsibility for the accuracy, legality or content of the third-party website or for that of subsequent links.

Except as expressly indicated in writing, Vishay products are not designed for use in medical, life-saving, or life-sustaining applications or for any other application in which the failure of the Vishay product could result in personal injury or death. Customers using or selling Vishay products not expressly indicated for use in such applications do so at their own risk. Please contact authorized Vishay personnel to obtain written terms and conditions regarding products designed for such applications.

No license, express or implied, by estoppel or otherwise, to any intellectual property rights is granted by this document or by any conduct of Vishay. Product names and markings noted herein may be trademarks of their respective owners.