



Main

Range of Product	Telemecanique Photoelectric sensors XU
Series name	Application material handling
Electronic sensor type	Photo-electric sensor
Sensor name	XUJ
Sensor design	Compact
Detection system	Diffuse
Material	Plastic
Line of sight type	Axial
Type of output signal	Analogue
Supply circuit type	DC
Wiring Technique	3-wire
Discrete output type	PNP
Analogue output range	4...20 mA
Electrical connection	Screw-clamp terminals, 1 x 2.5...2 x 1.5 mm ²
Product Specific Application	-
Emission	Infrared diffuse
[Sn] nominal sensing distance	0.66...2.62 ft (0.2...0.8 m) diffuse

Complementary

Enclosure Material	PEI
Maximum sensing distance	2.62 ft (0.8 m)
Output Type	Solid state
Add on output	With analogue output
Wire insulation material	PVC
Status LED	1 LED yellow)output state
[Us] rated supply voltage	12...24 V DC
Supply voltage limits	20...30 V DC
Output voltage	0...10 V DC
Switching capacity in mA	<= 100 mA overload and short-circuit protection)
Switching frequency	<= 250 Hz
Maximum voltage drop	<1.5 V closed state)
Current consumption	<= 35 mA no-load
Maximum delay first up	15 ms
Maximum delay response	2 ms
Maximum delay recovery	2 ms
Setting-up	Without sensitivity adjustment
Depth	1.97 in (50 mm)
Height	1.97 in (50 mm)
Width	0.71 in (18 mm)
Net Weight	0.15 lb(US) (0.07 kg)

The information provided in this documentation contains general descriptions and/or technical characteristics of the performance of the products contained herein. This documentation is not intended as a substitute for and is not to be used for determining suitability or reliability of these products for specific user applications. It is the duty of any such user or integrator to perform the appropriate and complete risk analysis, evaluation and testing of the products with respect to the relevant specific application or use thereof. Neither Schneider Electric Industries SAS nor any of its affiliates or subsidiaries shall be responsible or liable for misuse of the information contained herein.

Environment

Product Certifications	CE UL CSA
Ambient air temperature for operation	-13...131 °F (-25...55 °C)
Ambient Air Temperature for Storage	-40...158 °F (-40...70 °C)
Vibration resistance	7 gn +/- 1.5 mm 10...55 Hz IEC 60068-2-6
Shock resistance	30 gn 11 ms) IEC 60068-2-27
IP degree of protection	IP65 double insulation IEC 60529



Ordering and shipping details

Category	22481-SENSORS, PHOTOELECTRIC
Discount Schedule	DS2
GTIN	3389110622898
Nbr. of units in pkg.	1
Package weight(Lbs)	7.55 oz (214.0 g)
Returnability	No
Country of origin	FR

Packing Units

Unit Type of Package 1	PCE
Package 1 Height	1.85 in (4.7 cm)
Package 1 width	4.37 in (11.1 cm)
Package 1 Length	6.50 in (16.5 cm)
Unit Type of Package 2	S02
Number of Units in Package 2	12
Package 2 Weight	6.37 lb(US) (2.89 kg)
Package 2 Height	5.91 in (15 cm)
Package 2 width	11.81 in (30 cm)
Package 2 Length	15.75 in (40 cm)

Offer Sustainability

California proposition 65	WARNING: This product can expose you to chemicals including: Diisononyl phthalate (DINP), which is known to the State of California to cause cancer, and Di-isodecyl phthalate (DIDP), which is known to the State of California to cause birth defects or other reproductive harm. For more information go to www.P65Warnings.ca.gov
REACH Regulation	 REACH Declaration
EU RoHS Directive	Pro-active compliance (Product out of EU RoHS legal scope)  EU RoHS Declaration
Mercury free	Yes
RoHS exemption information	 Yes

Contractual warranty

Warranty	18 months
----------	-----------

Dimensions

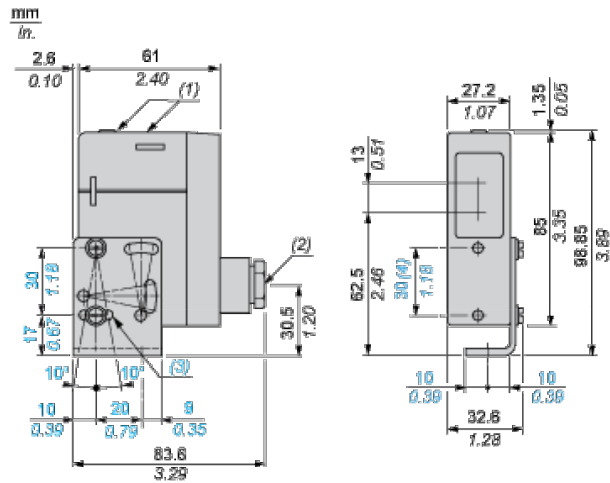

- (1) LED
- (2) 11P cable gland
- (3) 1 elongated hole $\text{Ø } 4.2 \times 14$
- (4) Front fixing ($\text{Ø } 4$ screws and inserts included)

Wiring Schemes

Diffuse System

Current Output

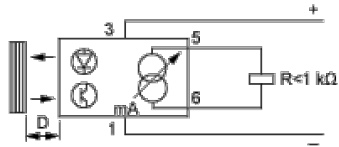

- 1: (-)
- 3: (+)
- 5: Output current
- 6: (-)

Voltage Output

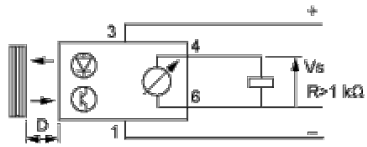

- 1: (-)
- 3: (+)
- 4: Output voltage
- 6: (-)

Curves

Output Signal (Related to Distance of Object). Test Performed with 20 x 20 cm, White 90% Object

Output Current

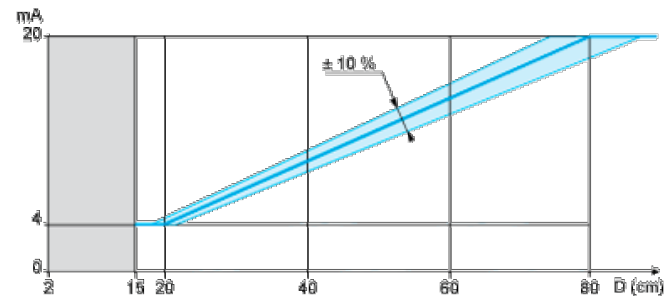

Output Voltage

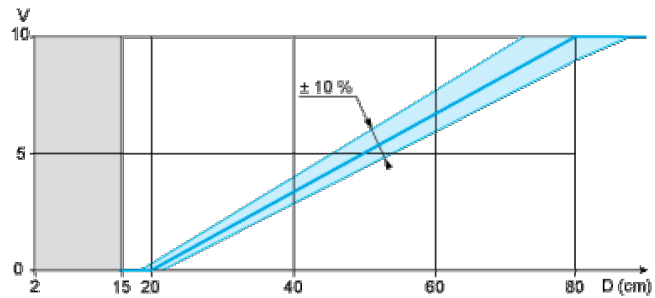

(1)

(1) Forbidden zone