

N-channel 800 V, 380 mΩ typ., 10 A MDmesh K6 Power MOSFET in a DPAK package

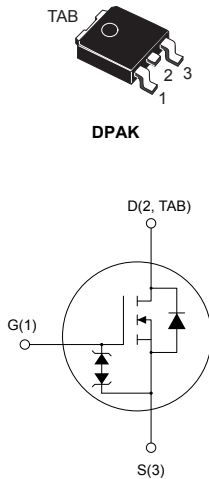

AM01476v1_tab



Features

Order code	V_{DS}	$R_{DS(on)}$ max.	I_D
STD80N450K6	800 V	450 mΩ	10 A

- Worldwide best $R_{DS(on)}$ x area
- Worldwide best FOM (figure of merit)
- Ultra low gate charge
- 100% avalanche tested
- Zener-protected

Applications

- Flyback converter
- Adapters for tablets, notebook and AIO
- LED lighting

Description

This very high voltage N-channel Power MOSFET is designed using the ultimate MDmesh K6 technology based on 20 years STMicroelectronics experience on super junction technology. The result is the best-in-class on-resistance per area and gate charge for applications requiring superior power density and high efficiency.

Product status link

[STD80N450K6](#)

Product summary

Order code	STD80N450K6
Marking	80N450K6
Package	DPAK
Packing	Tape and reel

1 Electrical ratings

Table 1. Absolute maximum ratings

Symbol	Parameter	Value	Unit
V_{GS}	Gate-source voltage	± 30	V
$I_D^{(1)}$	Drain current (continuous) at $T_C = 25\text{ }^\circ\text{C}$	10	A
	Drain current (continuous) at $T_C = 100\text{ }^\circ\text{C}$	6	
$I_{DM}^{(2)}$	Drain current (pulsed)	18	A
P_{TOT}	Total power dissipation at $T_C = 25\text{ }^\circ\text{C}$	83	W
$dv/dt^{(3)}$	Peak diode recovery voltage slope	5	V/ns
$di/dt^{(3)}$	Peak diode recovery current slope	100	A/ μs
$dv/dt^{(4)}$	MOSFET dv/dt ruggedness	120	V/ns
T_{stg}	Storage temperature range	-55 to 150	$^\circ\text{C}$
T_J	Operating junction temperature range		

1. Referred to TO-220 package.
2. Pulse width limited by safe operating area.
3. $I_{SD} \leq 5\text{ A}$; $V_{DS} (\text{peak}) = 400\text{ V}$
4. $V_{DS} \leq 640\text{ V}$

Table 2. Thermal data

Symbol	Parameter	Value	Unit
R_{thJC}	Thermal resistance, junction-to-case	1.5	$^\circ\text{C/W}$
$R_{thJA}^{(1)}$	Thermal resistance, junction-to-ambient	50	$^\circ\text{C/W}$

1. When mounted on 1 inch² FR-4, 2 Oz copper board.

Table 3. Avalanche characteristics

Symbol	Parameter	Value	Unit
I_{AR}	Avalanche current, repetitive or not repetitive (pulse width limited by T_J max.)	3	A
E_{AS}	Single pulse avalanche energy (starting $T_J = 25\text{ }^\circ\text{C}$, $I_D = I_{AR}$, $V_{DD} = 50\text{ V}$)	100	mJ

2 Electrical characteristics

$T_C = 25\text{ °C}$ unless otherwise specified.

Table 4. On/off-state

Symbol	Parameter	Test conditions	Min.	Typ.	Max.	Unit
$V_{(BR)DSS}$	Drain-source breakdown voltage	$V_{GS} = 0\text{ V}$, $I_D = 1\text{ mA}$	800			V
I_{DSS}	Zero gate voltage drain current	$V_{GS} = 0\text{ V}$, $V_{DS} = 800\text{ V}$			1	μA
		$V_{GS} = 0\text{ V}$, $V_{DS} = 800\text{ V}$, $T_C = 125\text{ °C}^{(1)}$			50	μA
I_{GSS}	Gate body leakage current	$V_{DS} = 0\text{ V}$, $V_{GS} = \pm 20\text{ V}$			± 1	μA
$V_{GS(th)}$	Gate threshold voltage	$V_{DS} = V_{GS}$, $I_D = 100\text{ }\mu\text{A}$	3	3.5	4	V
$R_{DS(on)}$	Static drain-source on-resistance	$V_{GS} = 10\text{ V}$, $I_D = 5\text{ A}$		380	450	m Ω

1. Specified by design, not tested in production.

Table 5. Dynamic

Symbol	Parameter	Test conditions	Min.	Typ.	Max.	Unit
C_{iss}	Input capacitance	$V_{DS} = 400\text{ V}$, $f = 1\text{ MHz}$, $V_{GS} = 0\text{ V}$	-	700	-	pF
C_{oss}	Output capacitance		-	8	-	pF
$C_{o(tr)}^{(1)}$	Equivalent capacitance time related	$V_{DS} = 0\text{ to }640\text{ V}$, $V_{GS} = 0\text{ V}$	-	59	-	pF
$C_{o(er)}^{(2)}$	Equivalent capacitance energy related		-	10	-	pF
R_g	Intrinsic gate resistance	$f = 1\text{ MHz}$, $I_D = 0\text{ A}$	-	2	-	Ω
Q_g	Total gate charge	$V_{DD} = 640\text{ V}$, $I_D = 5\text{ A}$, $V_{GS} = 0\text{ to }10\text{ V}$ (see Figure 18. Test circuit for gate charge behavior)	-	17.3	-	nC
Q_{gs}	Gate-source charge		-	4	-	nC
Q_{gd}	Gate-drain charge		-	7	-	nC

1. $C_{o(tr)}$ is a constant capacitance value that gives the same charging time as C_{oss} while V_{DS} is rising from 0 V to the stated value.

2. $C_{o(er)}$ is a constant capacitance value that gives the same stored energy as C_{oss} while V_{DS} is rising from 0 V to the stated value.

Table 6. Switching times

Symbol	Parameter	Test conditions	Min.	Typ.	Max.	Unit
$t_{d(on)}$	Turn-on delay time	$V_{DD} = 400\text{ V}$, $I_D = 5\text{ A}$, $R_G = 4.7\text{ }\Omega$, $V_{GS} = 10\text{ V}$	-	10.6	-	ns
t_r	Rise time		-	4	-	ns
$t_{d(off)}$	Turn-off delay time	see (Figure 16. Test circuit for resistive load switching times and Figure 17. Switching time waveform)	-	28.8	-	ns
t_f	Fall time		-	12.7	-	ns

Table 7. Source-drain diode

Symbol	Parameter	Test conditions	Min.	Typ.	Max.	Unit
$I_{SD}^{(1)}$	Source-drain current		-		10	A
$I_{SDM}^{(2)}$	Source-drain current (pulsed)		-		18	A
$V_{SD}^{(3)}$	Forward on voltage	$I_{SD} = 10\text{ A}$, $V_{GS} = 0\text{ V}$	-		1.5	V
t_{rr}	Reverse recovery time	$I_{SD} = 10\text{ A}$, $di/dt = 100\text{ A}/\mu\text{s}$,	-	275		ns
Q_{rr}	Reverse recovery charge	$V_{DD} = 60\text{ V}$	-	3.6		μC
I_{RRM}	Reverse recovery current	(see Figure 19. Test circuit for inductive load switching and diode recovery times)	-	21		A
t_{rr}	Reverse recovery time	$I_{SD} = 10\text{ A}$, $di/dt = 100\text{ A}/\mu\text{s}$,	-	405		ns
Q_{rr}	Reverse recovery charge	$V_{DD} = 60\text{ V}$, $T_J = 150\text{ }^\circ\text{C}$	-	8.7		μC
I_{RRM}	Reverse recovery current	(see Figure 19. Test circuit for inductive load switching and diode recovery times)	-	18.3		A

1. Referred to TO-220 package.
2. Pulse width limited by safe operating area.
3. Pulsed: pulse duration = 300 μs , duty cycle 1.5%.

2.1 Electrical characteristics (curves)

Figure 1. Safe operating area

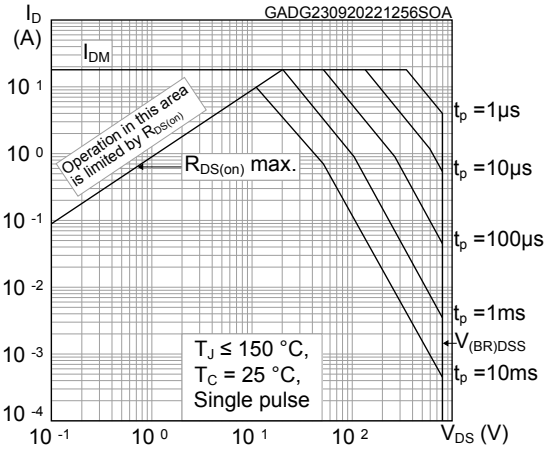

Figure 2. Maximum transient thermal impedance

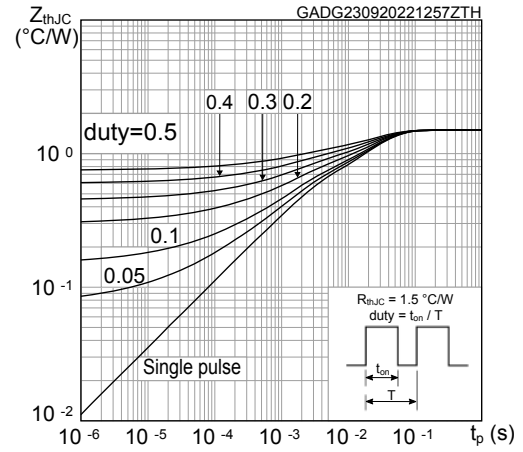

Figure 3. Typical output characteristics

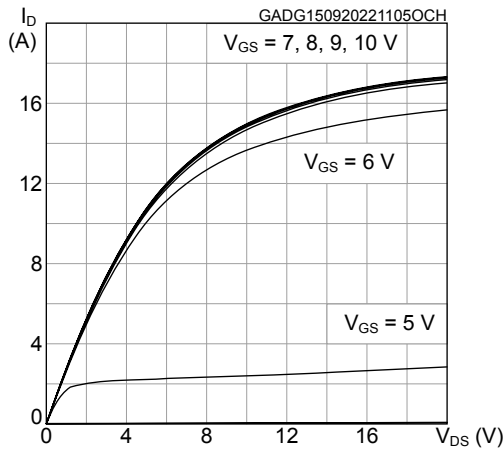

Figure 4. Typical transfer characteristics

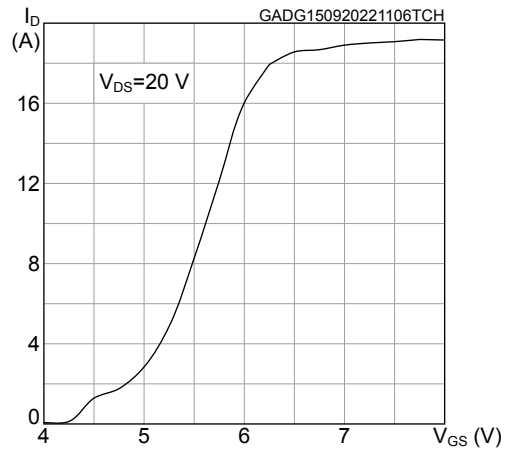

Figure 5. Typical drain-source on-resistance

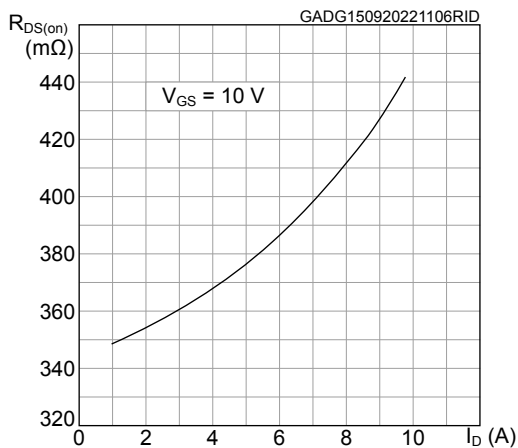

Figure 6. Normalized on-resistance vs temperature

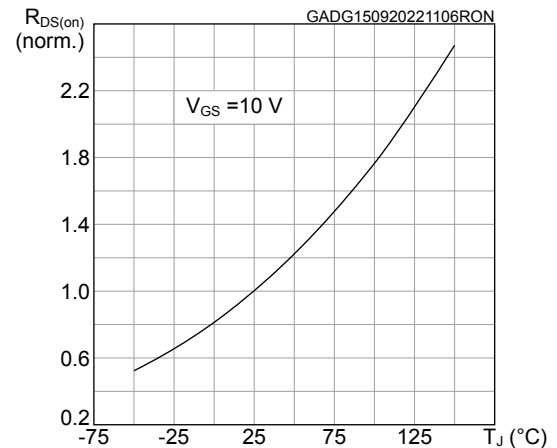

Figure 7. Typical gate charge characteristics

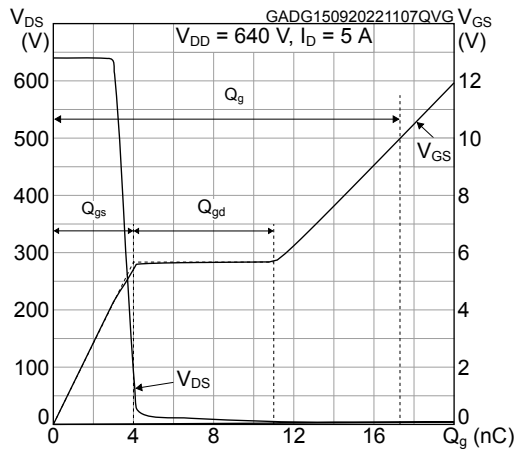

Figure 8. Typical capacitance characteristics

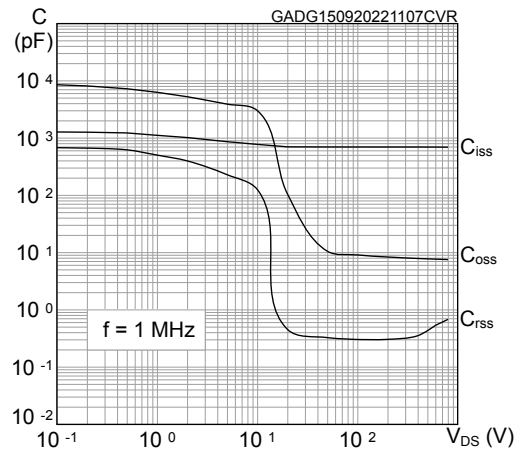

Figure 9. Normalized gate threshold vs temperature

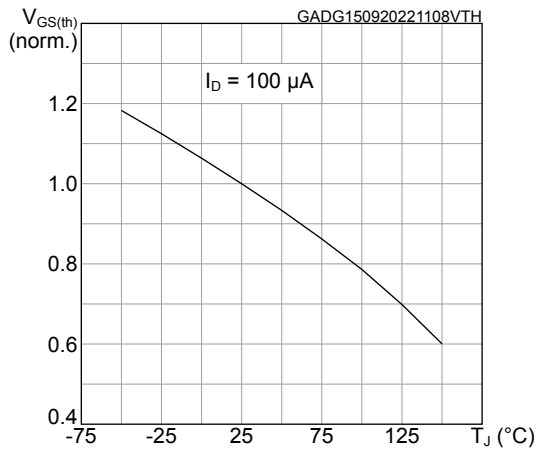

Figure 10. Normalized breakdown voltage vs temperature

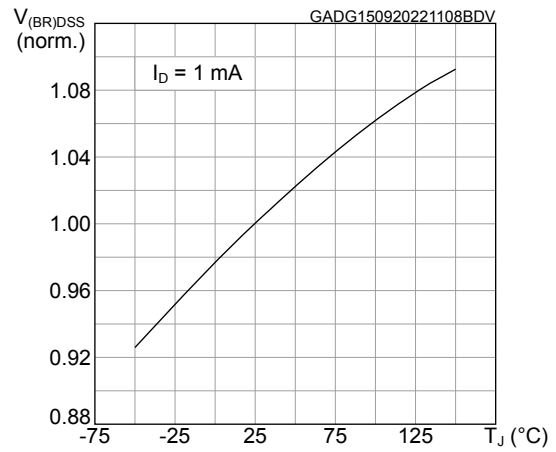

Figure 11. Typical output capacitance stored energy

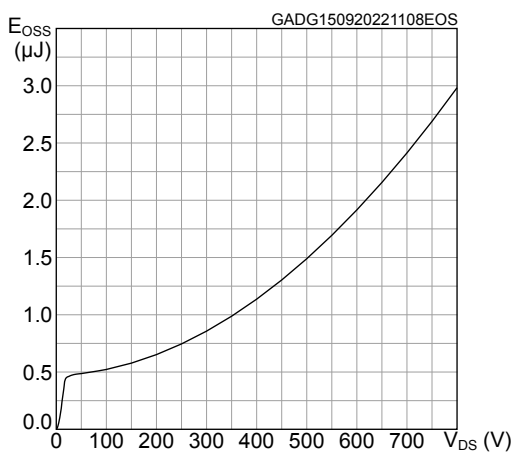

Figure 12. Maximum avalanche energy vs temperature

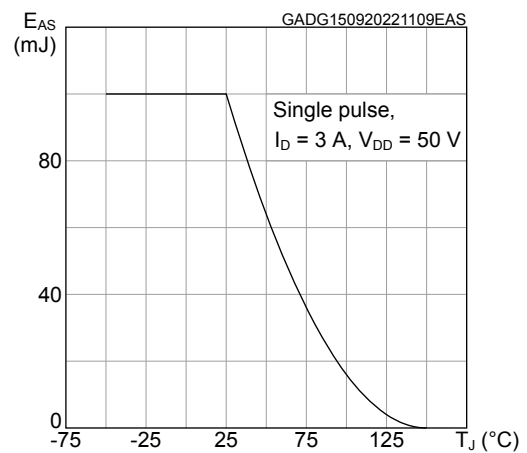

Figure 13. Typical reverse diode forward characteristics

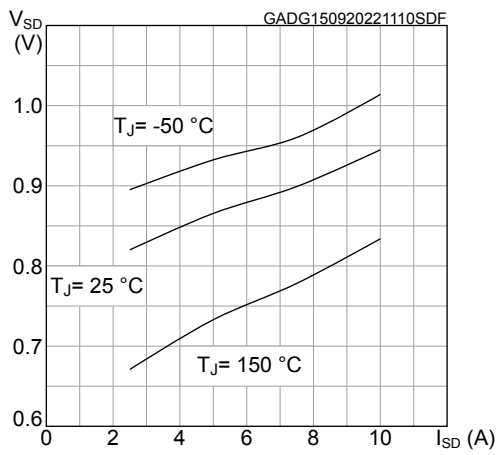

Figure 14. Typical inductive load switching energy vs I_D

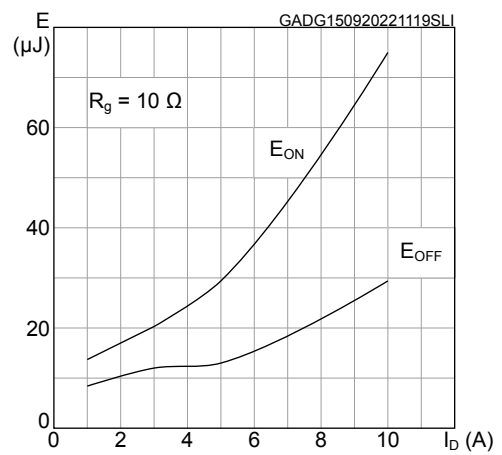
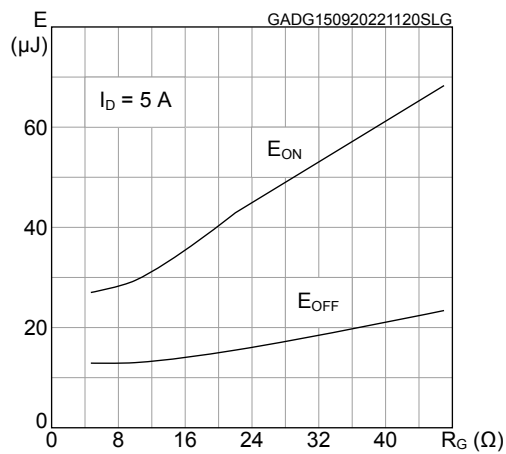
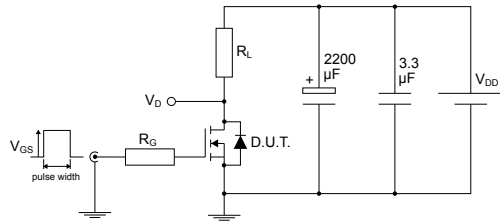

Figure 15. Typical inductive load switching energy vs R_G



3 Test circuits

Figure 16. Test circuit for resistive load switching times

AM01468v1

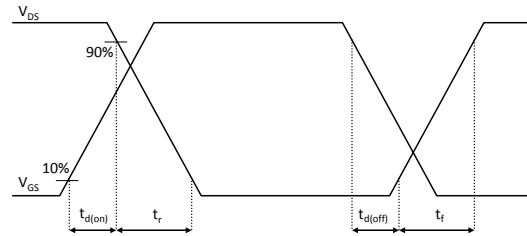
Figure 17. Switching time waveform

GADG280620211209SA

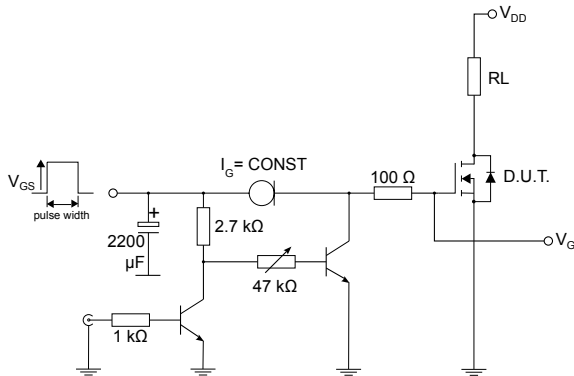
Figure 18. Test circuit for gate charge behavior

AM01469v10

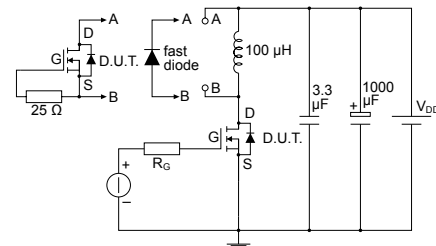
Figure 19. Test circuit for inductive load switching and diode recovery times

AM01470v1

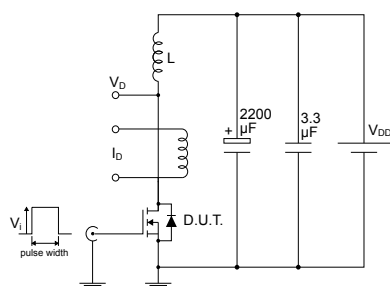
Figure 20. Unclamped inductive load test circuit

AM01471v1

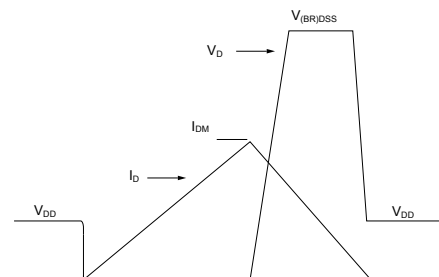
Figure 21. Unclamped inductive waveform

AM01472v1

4 Package information

In order to meet environmental requirements, ST offers these devices in different grades of **ECOPACK** packages, depending on their level of environmental compliance. ECOPACK specifications, grade definitions and product status are available at: www.st.com. ECOPACK is an ST trademark.

4.1 DPAK (TO-252) type A2 package information

Figure 22. DPAK (TO-252) type A2 package outline

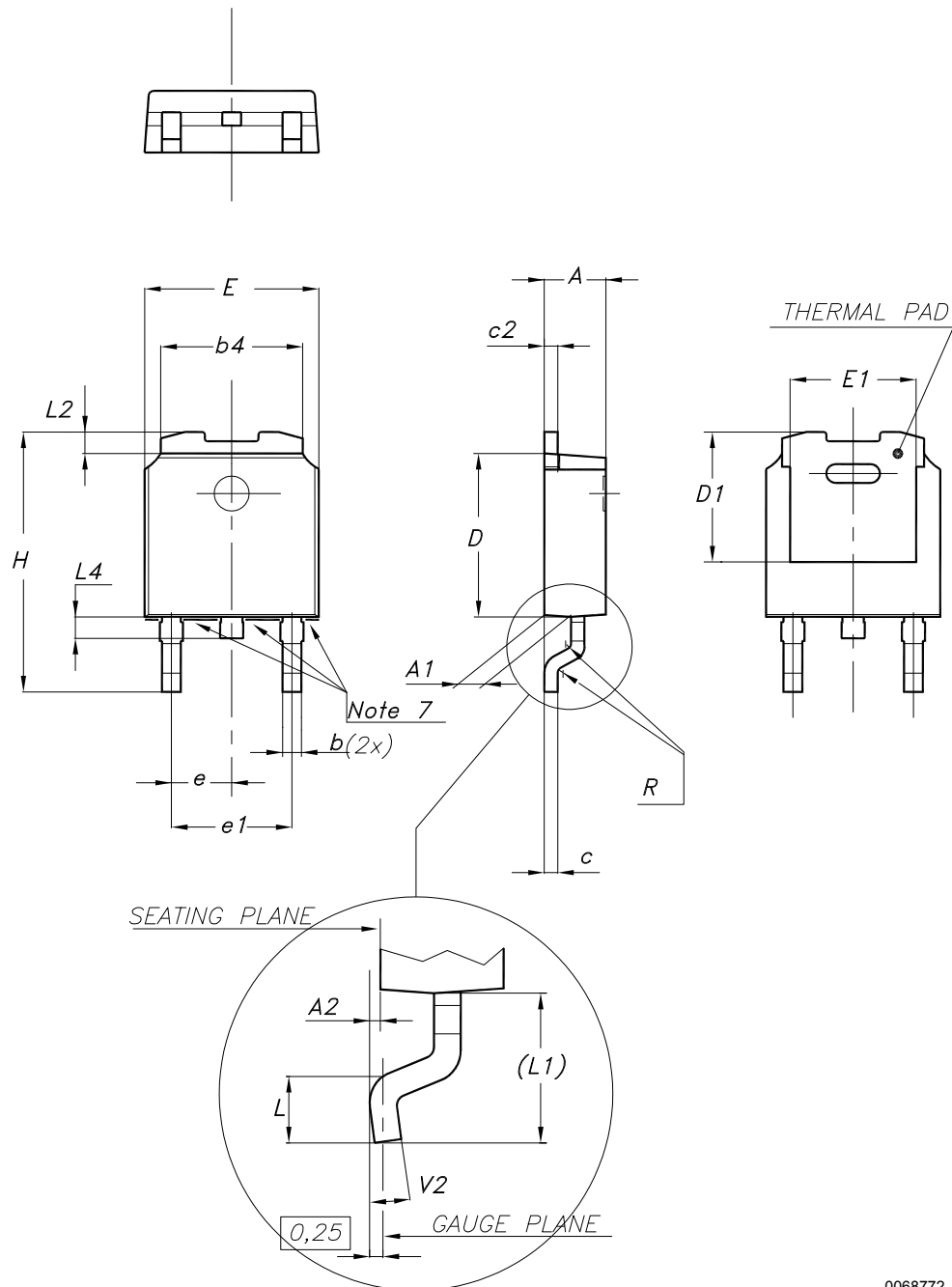

0068772_type-A2_rev34

Table 8. DPAK (TO-252) type A2 mechanical data

Dim.	mm		
	Min.	Typ.	Max.
A	2.20		2.40
A1	0.90		1.10
A2	0.03		0.23
b	0.64		0.90
b4	5.20		5.40
c	0.45		0.60
c2	0.48		0.60
D	6.00		6.20
D1	4.95	5.10	5.25
E	6.40		6.60
E1	5.10	5.20	5.30
e	2.159	2.286	2.413
e1	4.445	4.572	4.699
H	9.35		10.10
L	1.00		1.50
L1	2.60	2.80	3.00
L2	0.65	0.80	0.95
L4	0.60		1.00
R		0.20	
V2	0°		8°

4.2 DPAK (TO-252) type C3 package information

Figure 23. DPAK (TO-252) type C3 package outline

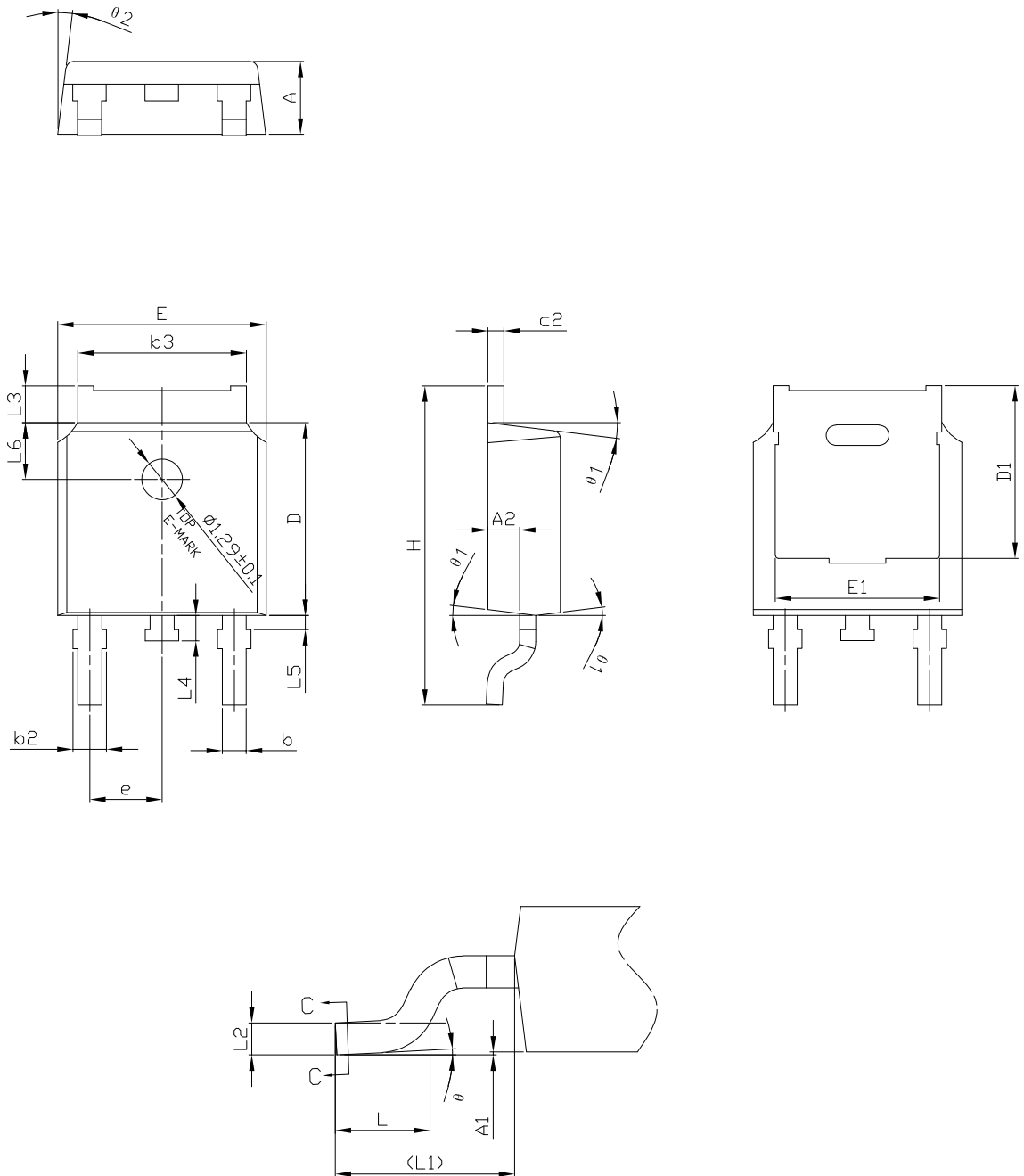

0068772_type-C3_rev34

Table 9. DPAK (TO-252) type C3 mechanical data

Dim.	mm		
	Min.	Typ.	Max.
A	2.20	2.30	2.38
A1	0.00		0.10
A2	0.90	1.01	1.10
b	0.72		0.85
b2	0.72		1.10
b3	5.13	5.33	5.46
c	0.47		0.60
c2	0.47		0.60
D	6.00	6.10	6.20
D1	5.20	5.45	5.70
E	6.50	6.60	6.70
E1	5.00	5.20	5.40
e	2.186	2.286	2.386
H	9.80	10.10	10.40
L	1.40	1.50	1.70
L1	2.90 REF		
L2	0.51 BSC		
L3	0.90		1.25
L4	0.60	0.80	1.00
L5	0.15		0.75
L6	1.80 REF		
θ	0°		8°
θ1	5°	7°	9°
θ2	5°	7°	9°

Figure 24. DPAK (TO-252) recommended footprint (dimensions are in mm)

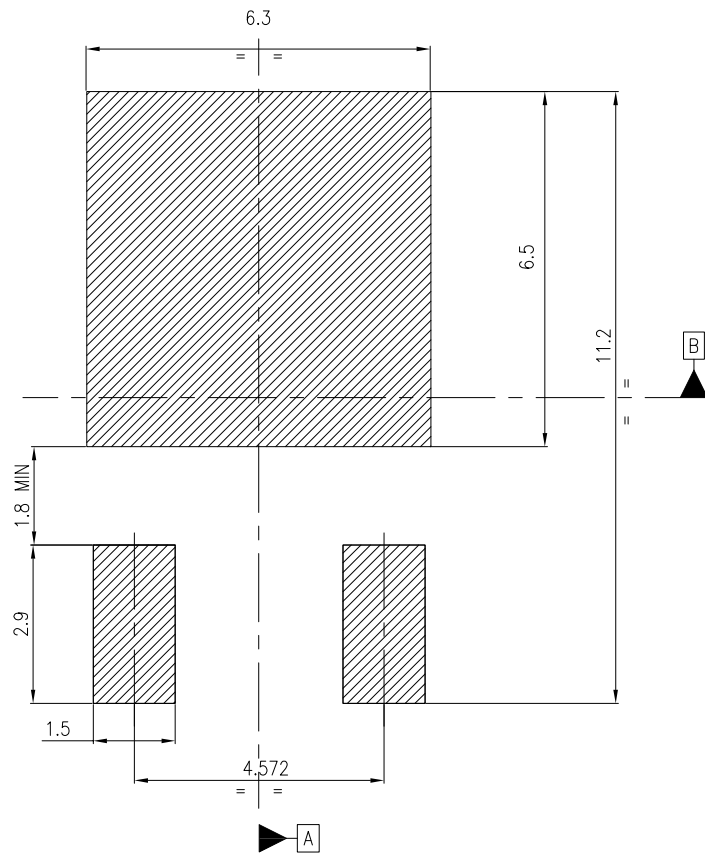

Notes:

- 1) This footprint is able to ensure insulation up to 630 Vrms (according to CEI IEC 664-1)
- 2) The device must be positioned within $\boxed{\oplus 0.05 \text{ A B}}$

FP_0068772_34

4.3 DPAK (TO-252) packing information

Figure 25. DPAK (TO-252) tape outline

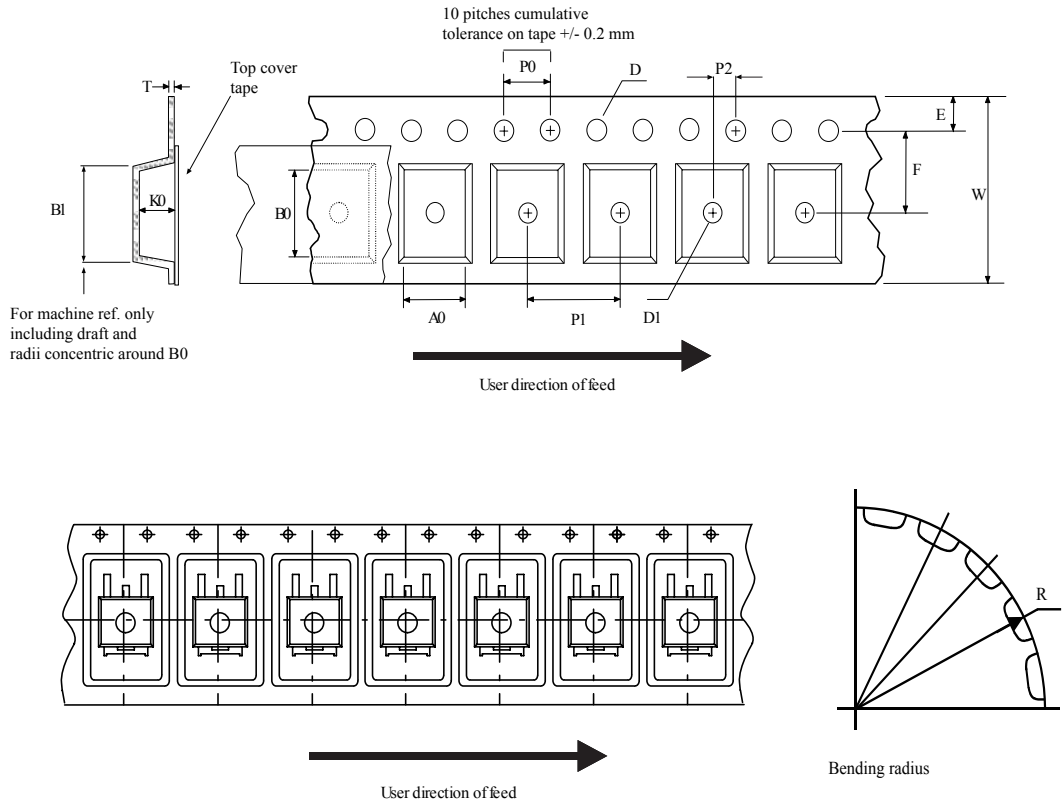

AM08852v1

Figure 26. DPAK (TO-252) reel outline

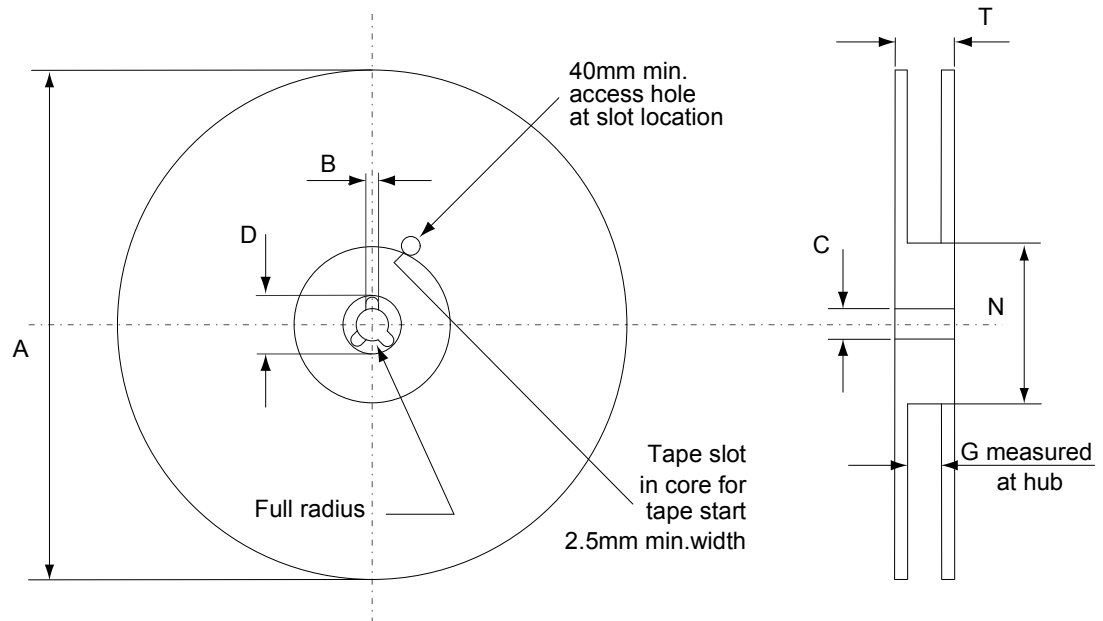

AM06038v1

Table 10. DPAK (TO-252) tape and reel mechanical data

Dim.	Tape		Dim.	Reel	
	mm			mm	
	Min.	Max.		Min.	Max.
A0	6.8	7	A		330
B0	10.4	10.6	B	1.5	
B1		12.1	C	12.8	13.2
D	1.5	1.6	D	20.2	
D1	1.5		G	16.4	18.4
E	1.65	1.85	N	50	
F	7.4	7.6	T		22.4
K0	2.55	2.75			
P0	3.9	4.1	Base qty.		2500
P1	7.9	8.1	Bulk qty.		2500
P2	1.9	2.1			
R	40				
T	0.25	0.35			
W	15.7	16.3			

Revision history

Table 11. Document revision history

Date	Revision	Changes
26-Sep-2022	1	First release.
05-May-2023	2	Updated Section 4.1 DPAK (TO-252) type A2 package information. Added Section 4.2 DPAK (TO-252) type C3 package information.

Contents

1	Electrical ratings	2
2	Electrical characteristics	3
2.1	Electrical characteristics (curves)	5
3	Test circuits	8
4	Package information	9
4.1	DPAK (TO-252) type A2 package information	9
4.2	DPAK (TO-252) type C3 package information	11
4.3	DPAK (TO-252) packing information	14
	Revision history	16

IMPORTANT NOTICE – READ CAREFULLY

STMicroelectronics NV and its subsidiaries (“ST”) reserve the right to make changes, corrections, enhancements, modifications, and improvements to ST products and/or to this document at any time without notice. Purchasers should obtain the latest relevant information on ST products before placing orders. ST products are sold pursuant to ST’s terms and conditions of sale in place at the time of order acknowledgment.

Purchasers are solely responsible for the choice, selection, and use of ST products and ST assumes no liability for application assistance or the design of purchasers’ products.

No license, express or implied, to any intellectual property right is granted by ST herein.

Resale of ST products with provisions different from the information set forth herein shall void any warranty granted by ST for such product.

ST and the ST logo are trademarks of ST. For additional information about ST trademarks, refer to www.st.com/trademarks. All other product or service names are the property of their respective owners.

Information in this document supersedes and replaces information previously supplied in any prior versions of this document.

© 2023 STMicroelectronics – All rights reserved