

Quad smart power solid state relay for complete H-bridge configurations

Datasheet - production data

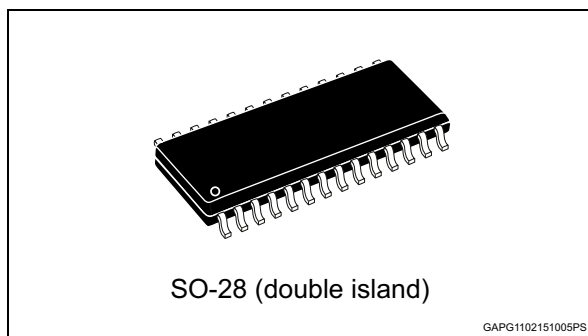

- Thermal shutdown indication on both the high and low-side switches

Applications

- DC motor driving in full or half bridge configuration
- All types of resistive, inductive and capacitive loads

Description

The VN5770AKP-E is a device formed by three monolithic chips housed in a standard SO-28 package: a double high-side and two low-side switches. The double high-side is made using STMicroelectronics® VIPower® M0-5 technology, while the low-side switches are fully protected VIPower M0-3 OMNIFET II. This device is suitable to drive a DC motor in a bridge configuration as well as to be used as a quad switch for any low voltage application.

The dual high-side switches integrate built in non latching thermal shutdown with thermal hysteresis. An output current limiter protects the device in overload condition. In case of long overload duration, the device limits the dissipated power to a safe level up to thermal shutdown intervention. An analog current sense pin delivers a current proportional to the load current (according to a known ratio) and indicates overtemperature shutdown of the relevant high-side switch through a voltage flag.

The low-side switches have built in non latching thermal shutdown with thermal hysteresis, linear current limitation and overvoltage clamping.

Fault feedback for overtemperature shutdown of the low-side switch is indicated by the relevant input pin current consumption going up to the fault sink current flag.

Features

Type	R _{DS(on)}	I _{OUT} (typ)	V _{CC}
VN5770AKP-E	280 mΩ ⁽¹⁾	8.5 A	36 V

1. Total resistance of one side in bridge configuration

- ECOPACK®: lead free and RoHS compliant
- Automotive Grade: compliance with AEC guidelines
- General features
 - Inrush current management by active power limitation on the high-side switches
 - Very low standby current
 - Very low electromagnetic susceptibility
 - Compliance with European directive 2002/95/EC
- Protection
 - High-side drivers undervoltage shutdown
 - Overvoltage clamp
 - Output current limitation
 - High and low-side overtemperature shutdown
 - Short circuit protection
 - ESD protection
- Diagnostic functions
 - Proportional load current sense

Contents

- 1 Block diagram and pin descriptions 5**
- 2 Absolute maximum ratings 8**
 - 2.1 Absolute maximum ratings 8
- 3 Electrical characteristics 10**
 - 3.1 Electrical characteristics for dual high-side switch 10
- 4 Electrical characteristics curves for dual high-side switch 14**
 - 4.1 Electrical characteristics for low-side switches 16
 - 4.2 Electrical characteristics curves for low-side switches 18
- 5 Application information 21**
 - 5.1 Maximum demagnetization energy ($V_{CC} = 13.5\text{ V}$) 24
- 6 Package and thermal data 25**
 - 6.1 SO-28 thermal data 25
- 7 Package information 30**
 - 7.1 SO-28 package information 30
 - 7.2 SO-28 packing information 32
- 8 Order codes 35**
- 9 Revision history 36**

List of tables

Table 1.	Pin descriptions	6
Table 2.	Thermal data	7
Table 3.	Dual high-side switch	8
Table 4.	Low-side switch	9
Table 5.	Power section	10
Table 6.	Switching ($V_{CC} = 13\text{ V}$)	10
Table 7.	Logic input	11
Table 8.	Protection and diagnostics	11
Table 9.	Current sense ($8\text{V} < V_{CC} < 16\text{V}$)	12
Table 10.	Truth table.	13
Table 11.	Off.	16
Table 12.	On.	16
Table 13.	Dynamic ($T_j = 25^\circ\text{C}$, unless otherwise specified)	16
Table 14.	Switching ($T_j = 25^\circ\text{C}$, unless otherwise specified)	16
Table 15.	Source drain diode	17
Table 16.	Protection and diagnostics ($-40^\circ\text{C} < T_j < 150^\circ\text{C}$, unless otherwise specified)	17
Table 17.	Thermal calculations in clockwise and anti-clockwise operation in steady-state mode	26
Table 18.	Thermal resistances definitions	26
Table 19.	Single pulse thermal impedance definitions	27
Table 20.	Thermal calculations in transient mode	27
Table 21.	Thermal parameters	29
Table 22.	SO-28 mechanical data	30
Table 23.	Reel dimensions	32
Table 24.	SO-28 carrier tape dimensions	33
Table 25.	Device summary	35
Table 26.	Document revision history	36

List of figures

Figure 1.	Block diagram	5
Figure 2.	Configuration diagram (top view)	6
Figure 3.	Switching time waveforms	12
Figure 4.	Output voltage drop limitation	13
Figure 5.	Current sense delay characteristics	13
Figure 6.	Off-state output current	14
Figure 7.	High level input current	14
Figure 8.	Input clamp voltage	14
Figure 9.	Input low level	14
Figure 10.	Input high level	14
Figure 11.	Input hysteresis voltage	14
Figure 12.	On-state resistance vs T_{case}	15
Figure 13.	On-state resistance vs V_{CC}	15
Figure 14.	Undervoltage shutdown	15
Figure 15.	Turn-on voltage slope	15
Figure 16.	I_{LIMH} vs T_{case}	15
Figure 17.	Turn-off voltage slope	15
Figure 18.	Static drain source on resistance	18
Figure 19.	Derating curve	18
Figure 20.	Transconductance	18
Figure 21.	Transfer characteristics	18
Figure 22.	Input voltage vs input charge	18
Figure 23.	Capacitance variations	18
Figure 24.	Output characteristics	19
Figure 25.	Step response current limit	19
Figure 26.	Source-drain diode forward characteristics	19
Figure 27.	Static drain-source on resistance vs I_D	19
Figure 28.	Static drain-source on resistance vs input voltage (part 1)	19
Figure 29.	Static drain-source on resistance vs input voltage (part 2)	19
Figure 30.	Normalized input threshold voltage vs temperature	20
Figure 31.	Normalized on resistance vs temperature	20
Figure 32.	Current limit vs junction temperature	20
Figure 33.	Typical application schematic	21
Figure 34.	Recommended motor operation	22
Figure 35.	Waveforms	23
Figure 36.	Maximum turn off current versus load inductance	24
Figure 37.	SO-28 PC board	25
Figure 38.	Chipset configuration	25
Figure 39.	Auto and mutual $R_{thj-amb}$ vs PCB copper area in open box free air condition	26
Figure 40.	SO-28 HSD thermal impedance junction ambient single pulse	27
Figure 41.	SO-28 LSD thermal impedance junction ambient single pulse	28
Figure 42.	Thermal fitting model of an H-bridge in SO-28	28
Figure 43.	SO-28 package outline	30
Figure 44.	SO-28 tube shipment (no suffix)	32
Figure 45.	Reel for SO-28	32
Figure 46.	SO-28 carrier tape	33
Figure 47.	SO-28 schematic drawing of leader and trailer tape	34

1 Block diagram and pin descriptions

Figure 1. Block diagram

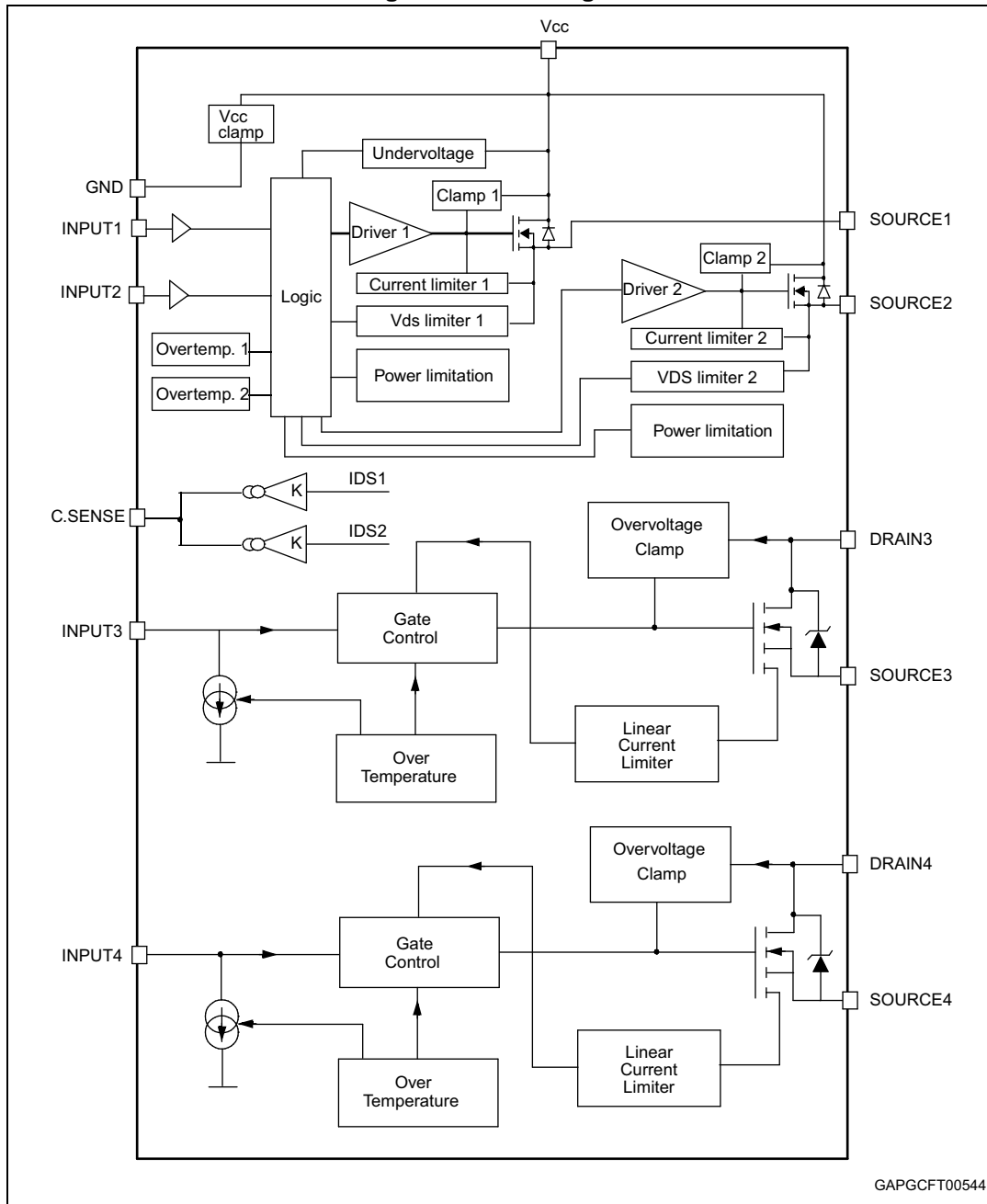

Table 1. Pin descriptions

No	Name	Function
1, 3, 25, 28	DRAIN 3	Drain of switch 3 (low-side switch)
2	INPUT 3	Input of switch 3 (low-side switch)
4, 11	N.C.	Not connected
5, 10, 19, 24	V _{CC}	Drain of switches 1 and 2 (high-side switches) and power supply voltage
6	GND	Ground of switches 1 and 2 (high-side switches)
7	INPUT 1	Input of switch 1 (high-side switches)
8	INPUT 2	Input of switch 2 (high-side switch)
9	CURRENT SENSE	Analog current sense pin, it delivers a current proportional to the load current
12, 14, 15, 18	DRAIN 4	Drain of switch 4 (low-side switch)
13	INPUT 4	Input of switch 4 (low-side switch)
16, 17	SOURCE 4	Source of switch 4 (low-side switch)
20, 21	SOURCE 2	Source of switch 2 (high-side switch)
22, 23	SOURCE 1	Source of switch 1 (high-side switch)
26, 27	SOURCE 3	Source of switch 3 (low-side switch)

Figure 2. Configuration diagram (top view)

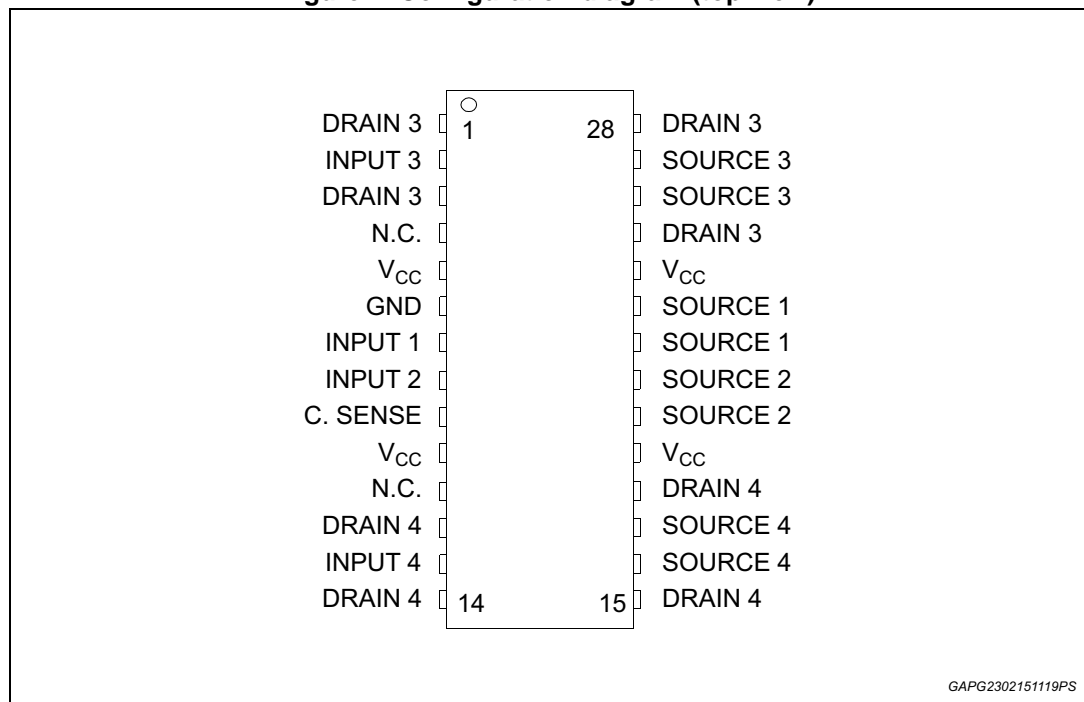

Table 2. Thermal data

Symbol	Parameter	Max value	Unit
$R_{thj-case}$	Thermal resistance junction-lead (high-side switch)	10	°C/W
$R_{thj-case}$	Thermal resistance junction-lead (low-side switch)	7	°C/W
$R_{thj-amb}$	Thermal resistance junction-ambient	See Figure 39	°C/W

2 Absolute maximum ratings

Stressing the device above the rating listed in [Table 3](#) and [Table 4](#) may cause permanent damage to the device. These are stress ratings only and operation of the device at these or any other conditions above those indicated in the Operating sections of this specification is not implied. Exposure to the conditions in [Section 2.1: Absolute maximum ratings](#) for extended periods may affect device reliability.

2.1 Absolute maximum ratings

Table 3. Dual high-side switch

Symbol	Parameter	Value	Unit
V_{CC}	DC supply voltage	41	V
$-V_{CC}$	Reverse DC supply voltage	0.3	V
$-I_{GND}$	DC reverse ground pin current	200	mA
I_{OUT}	DC output current	Internally limited	A
$-I_{OUT}$	Reverse DC output current	-12	A
I_{IN}	DC input current	-1 to 10	mA
I_{CSD}	DC current sense disable input current	-1 to 10	mA
V_{CSENSE}	Current sense maximum voltage	$V_{CC}-41$ $+V_{CC}$	V V
E_{MAX}	Maximum switching energy (single pulse) ($L = 3.7$ mH; $R_L = 0$ Ω ; $V_{bat} = 13.5$ V; $T_{jstart} = 150$ °C; $I_{OUT} = I_{limL}(Typ.)$)	32	mJ
V_{ESD}	Electrostatic discharge (Human Body Model: $R = 1.5$ K Ω ; $C = 100$ pF) – INPUT – CURRENT SENSE – OUTPUT – V_{CC}	4000 2000 5000 5000	V V V V
V_{ESD}	Charge device model (CDM-AEC-Q100-011)	750	V
T_j	Junction operating temperature	-40 to 150	°C
T_{stg}	Storage temperature	-55 to 150	°C

Table 4. Low-side switch

Symbol	Parameter	Value	Unit
V_{DSn}	Drain-source voltage ($V_{INn} = 0$ V)	Internally clamped	V
V_{INn}	Input voltage	Internally clamped	V
I_{INn}	Input current	+/-20	mA
$R_{IN\ MINn}$	Minimum input series impedance	220	Ω
I_{Dn}	Drain current	Internally limited	A
I_{Rn}	Reverse DC output current	-12	A
V_{ESD1}	Electrostatic discharge ($R = 1.5$ K Ω , $C = 100$ pF)	4000	V
V_{ESD2}	Electrostatic discharge on output pins only ($R = 330$ Ω , $C = 150$ pF)	16500	V
P_{tot}	Total dissipation at $T_c = 25$ °C	4	W
T_j	Operating junction temperature	Internally limited	°C
T_c	Case operating temperature	Internally limited	°C
T_{stg}	Storage temperature	-55 to 150	°C

3 Electrical characteristics

3.1 Electrical characteristics for dual high-side switch

Values specified in this section are for $8\text{ V} < V_{CC} < 36\text{ V}$; $-40\text{ °C} < T_j < 150\text{ °C}$, unless otherwise specified (for each channel).

Table 5. Power section

Symbol	Parameter	Test conditions	Min.	Typ.	Max.	Unit
V_{CC}	Operating supply voltage		4.5	13	36	V
V_{USD}	Undervoltage shutdown			3.5	4.5	V
$V_{USDhyst}$	Undervoltage shutdown hysteresis			0.5		V
R_{ON}	On-state resistance	$I_{OUT} = 3\text{ A}$; $T_j = 25\text{ °C}$		160		mΩ
		$I_{OUT} = 3\text{ A}$; $T_j = 150\text{ °C}$			320	mΩ
		$I_{OUT} = 3\text{ A}$; $V_{CC} = 5\text{ V}$; $T_j = 25\text{ °C}$			210	mΩ
V_{clamp}	Clamp Voltage	$I_S = 20\text{ mA}$	41	46	52	V
I_S	Supply current	Off-state; $V_{CC} = 13\text{ V}$; $T_j = 25\text{ °C}$; $V_{IN} = V_{OUT} = V_{SENSE} = 0\text{ V}$		2 ⁽¹⁾	5 ⁽¹⁾	μA
		On-state; $V_{CC} = 13\text{ V}$; $V_{IN} = 5\text{ V}$; $I_{OUT} = 0\text{ A}$		3	6	mA
$I_{L(off)}$	Off-state output current ⁽²⁾	$V_{IN} = V_{OUT} = 0\text{ V}$; $V_{CC} = 13\text{ V}$; $T_j = 25\text{ °C}$	0		3	μA
		$V_{IN} = V_{OUT} = 0\text{ V}$; $V_{CC} = 13\text{ V}$; $T_j = 125\text{ °C}$	0		5	μA
V_F	Output - V_{CC} diode voltage ⁽²⁾	$-I_{OUT} = 3\text{ A}$; $T_j = 150\text{ °C}$			0.7	V

1. PowerMOS leakage included

2. For each channel

Table 6. Switching ($V_{CC} = 13\text{ V}$)

Symbol	Parameter	Test conditions	Min.	Typ.	Max.	Unit
$t_{d(on)}$	Turn-on delay time	$R_L = 4.3\text{ Ω}$ (see Figure 3)	—	15	—	μs
$t_{d(off)}$	Turn-off delay time	$R_L = 4.3\text{ Ω}$ (see Figure 3)	—	10	—	μs
$(dV_{OUT}/dt)_{on}$	Turn-on voltage slope	$R_L = 4.3\text{ Ω}$	—	See Figure 15	—	V/μs
$(dV_{OUT}/dt)_{off}$	Turn-off voltage slope	$R_L = 4.3\text{ Ω}$	—	See Figure 17	—	V/μs
W_{ON}	Switching energy losses during t_{won}	$R_L = 4.3\text{ Ω}$ (see Figure 3)	—	0.16	—	mJ
W_{OFF}	Switching energy losses during t_{woff}	$R_L = 4.3\text{ Ω}$ (see Figure 3)	—	0.08	—	mJ

Table 7. Logic input

Symbol	Parameter	Test conditions	Min.	Typ.	Max.	Unit
V_{IL}	Input low level voltage				0.9	V
I_{IL}	Low level input current	$V_{IN} = 0.9\text{ V}$	1			μA
V_{IH}	Input high level voltage		2.1			V
I_{IH}	High level input current	$V_{IN} = 2.1\text{ V}$			10	μA
$V_{I(hyst)}$	Input hysteresis voltage		0.25			V
V_{ICL}	Input clamp voltage	$I_{IN} = 1\text{ mA}$	5.5		7	V
		$I_{IN} = -1\text{ mA}$		-0.7		V

Table 8. Protection and diagnostics⁽¹⁾

Symbol	Parameter	Test conditions	Min.	Typ.	Max.	Unit
I_{limH}	DC Short circuit current	$V_{CC} = 13\text{ V}$	6	8.5	12	A
		$5\text{ V} < V_{CC} < 36\text{ V}$			12	A
I_{limL}	Short circuit current during thermal cycling	$V_{CC} = 13\text{ V}; T_R < T_j < T_{TSD}$		3.5		A
T_{TSD}	Shutdown temperature		150	175	200	$^{\circ}\text{C}$
T_R	Reset temperature		$T_{RS} + 1$	$T_{RS} + 5$		$^{\circ}\text{C}$
T_{RS}	Thermal reset of STATUS		135			$^{\circ}\text{C}$
T_{HYST}	Thermal hysteresis ($T_{TSD} - T_R$)			7		$^{\circ}\text{C}$
V_{DEMAG}	Turn-off output voltage clamp	$I_{OUT} = 1\text{ A}; V_{IN} = 0;$ $L = 20\text{ mH}$	$V_{CC} - 41$	$V_{CC} - 46$	$V_{CC} - 52$	V
V_{ON}	Output voltage drop limitation	$I_{OUT} = 0.03\text{ A};$ $T_j = -40\text{ }^{\circ}\text{C}$ to $150\text{ }^{\circ}\text{C}$ (see Figure 4)		25		mV

1. To ensure long term reliability under heavy overload or short circuit conditions, protection and related diagnostic signals must be used together with a proper software strategy. If the device is subjected to abnormal conditions, this software must limit the duration and number of activation cycles

Table 9. Current sense (8V<V_{CC}<16V)

Symbol	Parameter	Test conditions	Min.	Typ.	Max.	Unit
K ₀	I _{OUT} /I _{SENSE}	I _{OUT} = 0.08 A; V _{SENSE} = 0.5 V; T _j = -40°C to 50°C	850	1450	2120	
K ₁	I _{OUT} /I _{SENSE}	I _{OUT} = 0.35 A; V _{SENSE} = 0.5V; T _j = -40°C to 150°C T _j = 25°C to 150°C	840 980	1360 1360	2000 1740	
K ₂	I _{OUT} /I _{SENSE}	I _{OUT} = 3A; V _{SENSE} = 4V; T _j = -40°C to 150°C	1200	1270	1350	
K ₃	I _{OUT} /I _{SENSE}	I _{OUT} = 4A; V _{SENSE} = 4V; T _j = -40°C to 150°C	1200	1270	1350	
I _{SENSE0}	Analog sense current	I _{OUT} = 0A; V _{SENSE} = 0V; V _{IN} = 0V; T _j = -40°C to 150°C	0		1	μA
		I _{OUT} = 0A; V _{SENSE} = 0V; V _{IN} = 5V; T _j = -40°C to 150°C	0		2	μA
V _{SENSE}	Max analog sense output voltage	I _{OUT} = 5A; R _{SENSE} = 3.9 KΩ	5			V
V _{SENSEH}	Analog sense output voltage in overtemperature condition	V _{CC} = 13V; R _{SENSE} = 3.9 KΩ		9		V
I _{SENSEH}	Analog sense output current in overtemperature condition	V _{CC} = 13V		8		mA
t _{DSENSE2H}	Delay response time from rising edge of INPUT pin	V _{SENSE} <4 V; 0.35 A<I _{out} <5 A; I _{SENSE} = 90% of I _{SENSE} max (see Figure 5)		70	300	μs
t _{DSENSE2L}	Delay response time from falling edge of INPUT pin	V _{SENSE} <4 V; 0.35 A<I _{out} <5 A; I _{SENSE} = 10% of I _{SENSE} max (see Figure 5)		100	250	μs

Figure 3. Switching time waveforms

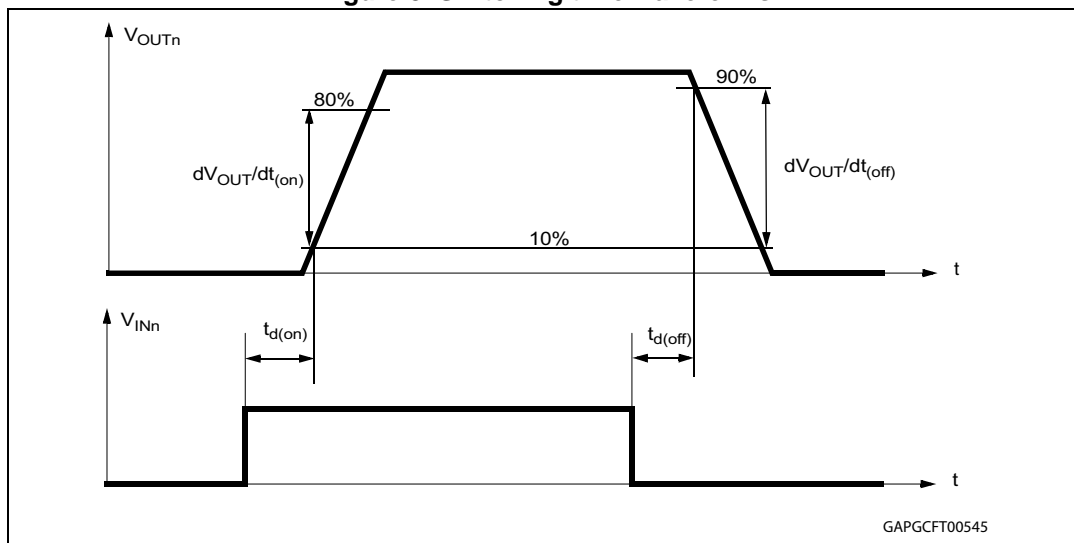

GAPGCFT00545

Figure 4. Output voltage drop limitation

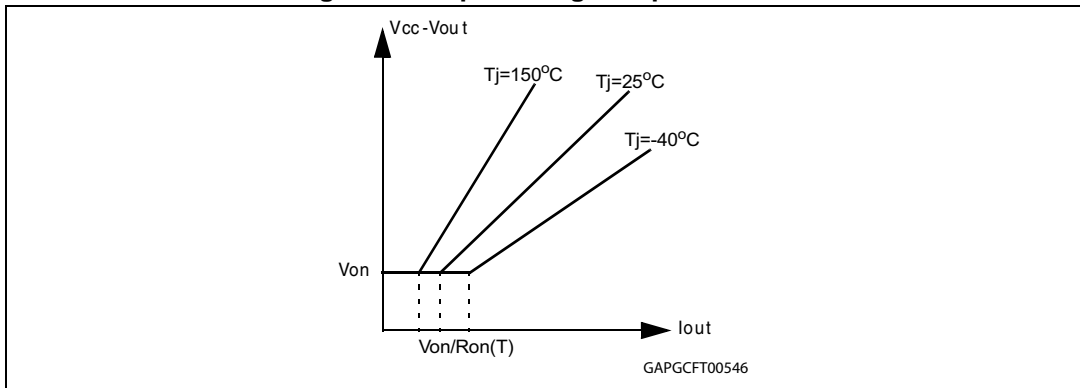
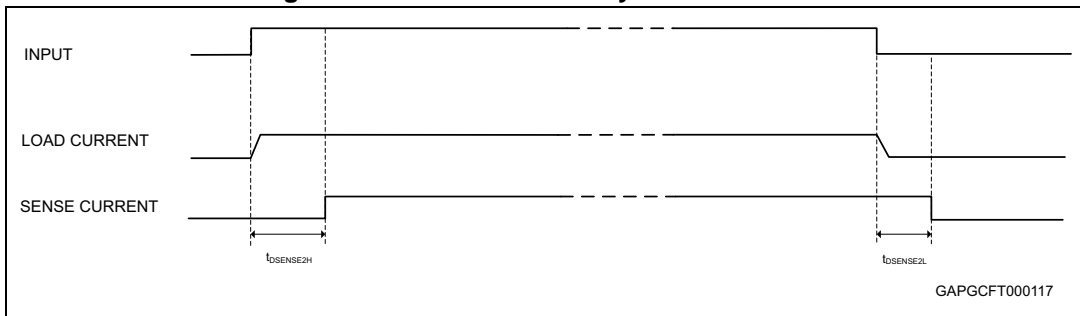

Table 10. Truth table

Conditions	Input	Output	Sense
Normal operation	L	L	0
	H	H	Nominal
Overtemperature	L	L	0
	H	L	V_{SENSEH}
Undervoltage	L	L	0
	H	L	0
Short circuit to GND	L	L	0
	H	L	0
Short circuit to V_{CC}	L	H	0
	H	H	< Nominal
Negative output voltage clamp	L	L	0

Figure 5. Current sense delay characteristics



4 Electrical characteristics curves for dual high-side switch

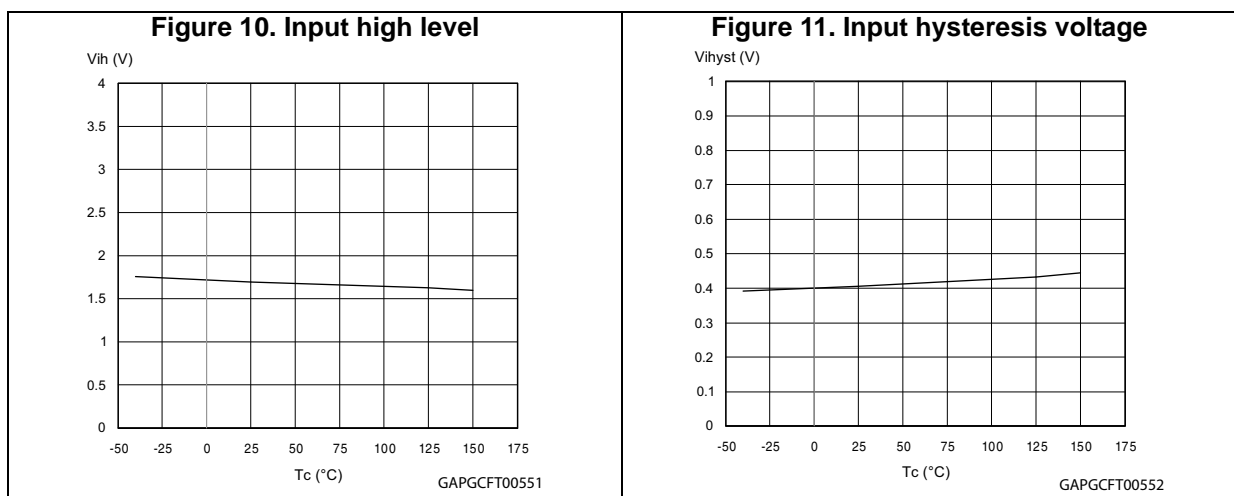
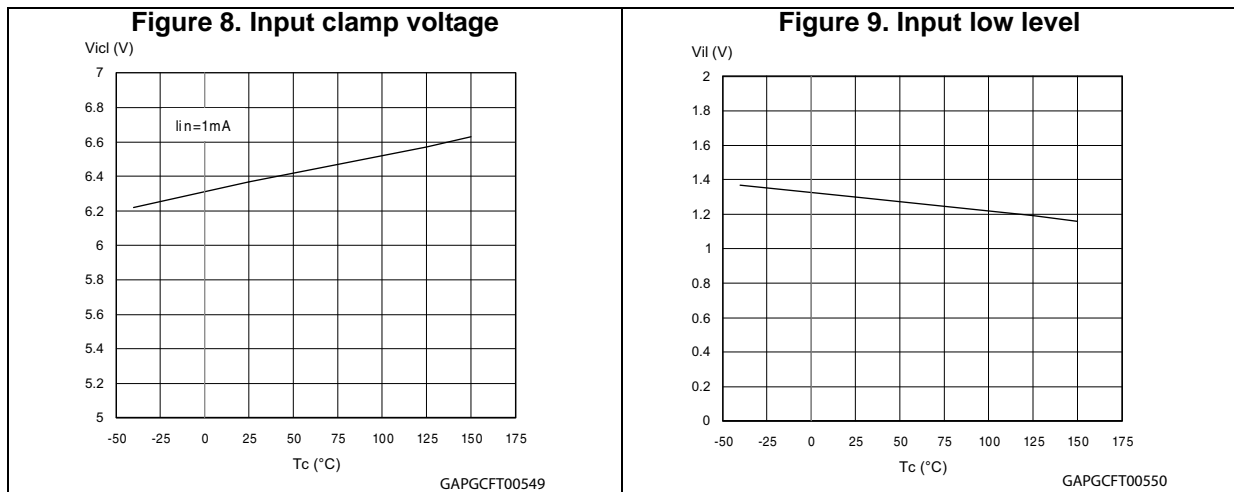
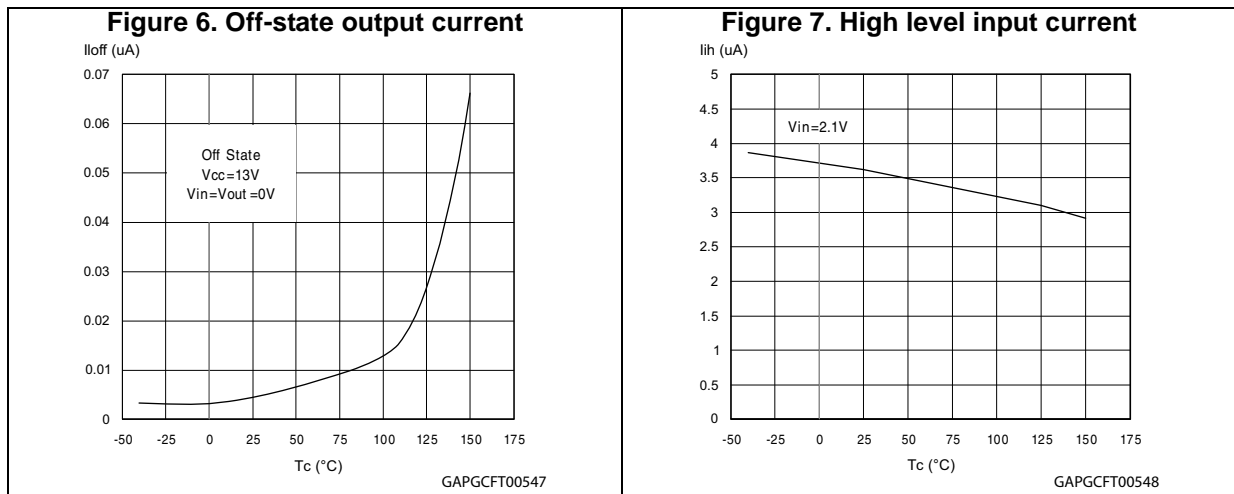

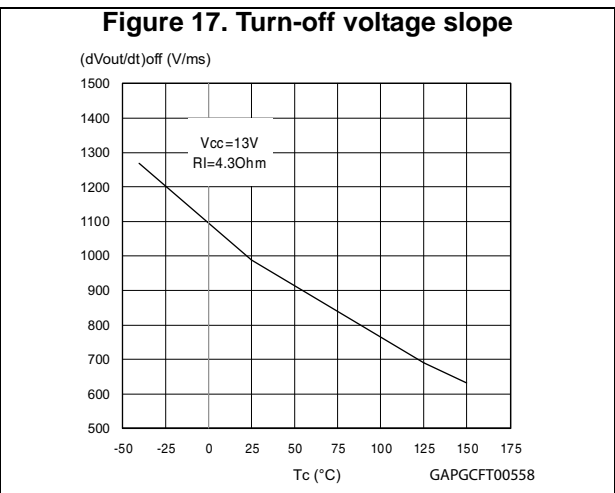
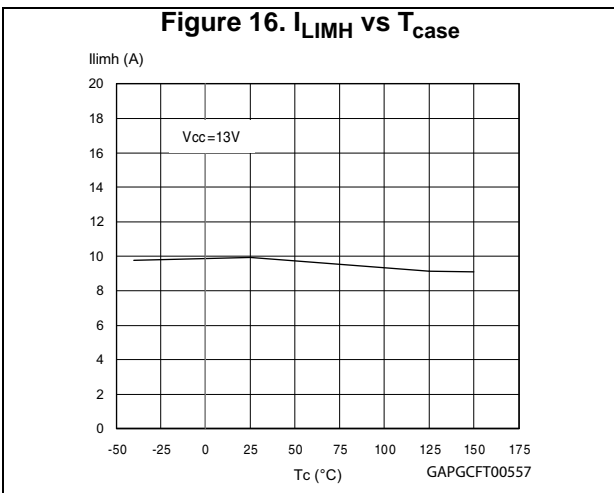
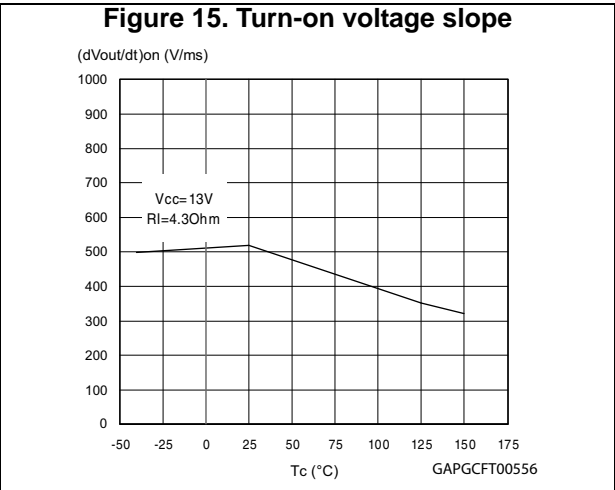
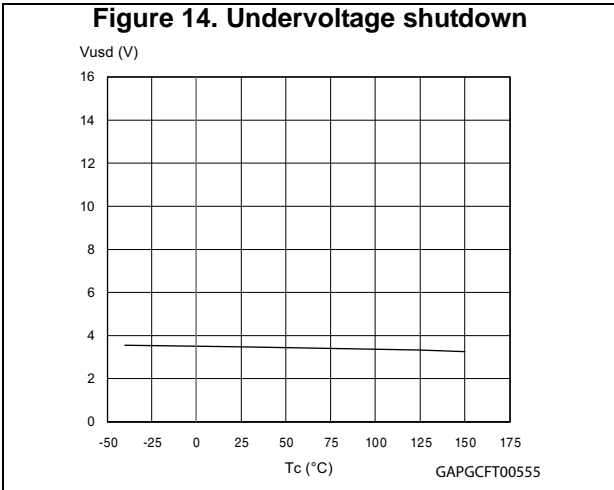
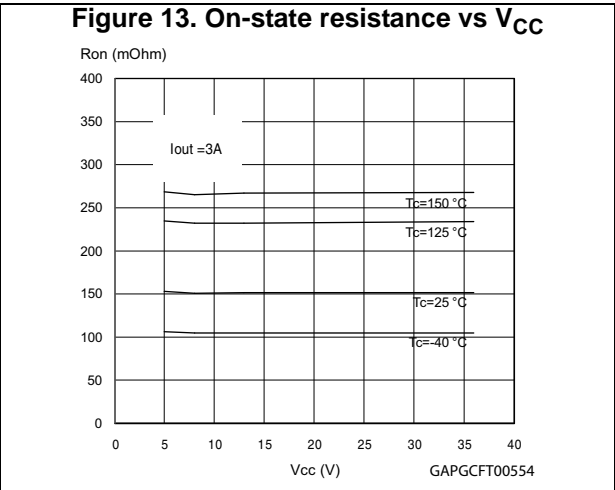
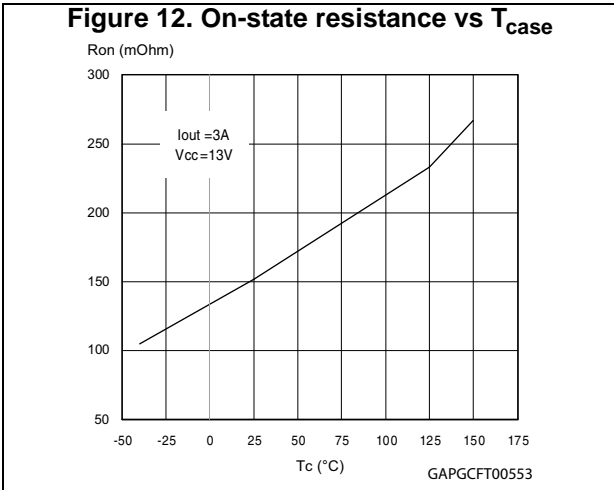

4.1 Electrical characteristics for low-side switches

Values specified in this section are for $-40\text{ °C} < T_j < 150\text{ °C}$, unless otherwise specified

Table 11. Off

Symbol	Parameter	Test conditions	Min	Typ	Max	Unit
V_{CLAMP}	Drain-source clamp voltage	$V_{IN} = 0\text{ V}; I_D = 1.5\text{ A}$	40	45	55	V
V_{CLTH}	Drain-source clamp threshold voltage	$V_{IN} = 0\text{ V}; I_D = 2\text{ mA}$	36			V
V_{INTH}	Input threshold voltage	$V_{DS} = V_{IN}; I_D = 1\text{ mA}$	0.5		2.5	V
I_{ISS}	Supply current from input pin	$V_{DS} = 0\text{ V}; V_{IN} = 5\text{ V}$		100	150	μA
V_{INCL}	Input-source clamp voltage	$I_{IN} = 1\text{ mA}$	6	6.8	8	V
		$I_{IN} = -1\text{ mA}$	-1.0		-0.3	V
I_{DSS}	Zero input voltage drain current ($V_{IN} = 0\text{V}$)	$V_{DS} = 13\text{ V}; V_{IN} = 0\text{ V}; T_j = 25\text{ °C}$			30	μA
		$V_{DS} = 25\text{ V}; V_{IN} = 0\text{ V}$			75	μA

Table 12. On

Symbol	Parameter	Test conditions	Min	Typ	Max	Unit
$R_{DS(on)}$	Static drain-source on resistance	$V_{IN} = 5\text{ V}; I_D = 3\text{ A}; T_j = 25\text{ °C}$	—	—	120	$\text{m}\Omega$
		$V_{IN} = 5\text{ V}; I_D = 3\text{ A}$	—	—	240	$\text{m}\Omega$

Table 13. Dynamic ($T_j = 25\text{ °C}$, unless otherwise specified)

Symbol	Parameter	Test conditions	Min	Typ	Max	Unit
g_{fs}	Forward transconductance	$V_{DD} = 13\text{ V}; I_D = 1.5\text{ A}$	—	2.5	—	S
C_{OSS}	Output capacitance	$V_{DS} = 13\text{ V}; f = 1\text{ MHz}; V_{IN} = 0\text{ V}$	—	150	—	pF

Table 14. Switching ($T_j = 25\text{ °C}$, unless otherwise specified)

Symbol	Parameter	Test conditions	Min	Typ	Max	Unit
$t_{d(on)}$	Turn-on delay time	$V_{DD} = 15\text{ V}; I_D = 3\text{ A}; V_{gen} = 5\text{ V}; R_{gen} = R_{IN\ MINn} = 220\ \Omega$	—	200	400	ns
t_r	Rise time		—	1.2	2.5	μs
$t_{d(off)}$	Turn-off delay time		—	600	1350	ns
t_f	Fall time		—	400	1000	ns
$t_{d(on)}$	Turn-on delay time	$V_{DD} = 15\text{ V}; I_D = 3\text{ A}; V_{gen} = 5\text{ V}; R_{gen} = 2.2\ \text{K}\Omega$	—	0.80	2.5	μs
t_r	Rise time		—	3.7	7.5	μs
$t_{d(off)}$	Turn-off delay time		—	2.6	7.5	μs
t_f	Fall time		—	2.3	7.0	μs

Table 14. Switching ($T_j = 25\text{ °C}$, unless otherwise specified) (continued)

Symbol	Parameter	Test conditions	Min	Typ	Max	Unit
$(dI/dt)_{on}$	Turn-on current slope	$V_{DD} = 15\text{ V}$; $I_D = 3\text{ A}$; $V_{gen} = 5\text{ V}$; $R_{gen} = R_{IN\ MINn} = 220\ \Omega$	—	3.0		A/ μ s
Q_i	Total input charge	$V_{DD} = 12\text{ V}$; $I_D = 3\text{ A}$; $V_{IN} = 5\text{ V}$; $I_{gen} = 2.13\text{ mA}$	—	9.0		nC

Table 15. Source drain diode

Symbol	Parameter	Test conditions	Min	Typ	Max	Unit
$V_{SD}^{(1)}$	Forward on voltage	$I_{SD} = 1.5\text{ A}$; $V_{IN} = 0\text{ V}$	—	0.8	—	V
t_{rr}	Reverse recovery time	$I_{SD} = 1.5\text{ A}$; $dI/dt = 12\text{ A/ms}$; $V_{DD} = 30\text{ V}$; $L = 200\ \mu\text{H}$	—	400	—	ns
Q_{rr}	Reverse recovery charge		—	200	—	nC
I_{RRM}	Reverse recovery current		—	1.0	—	A

1. Pulsed: pulse duration = 300 μ s, duty cycle 1.5%

Table 16. Protection and diagnostics ($-40\text{ °C} < T_j < 150\text{ °C}$, unless otherwise specified)

Symbol	Parameter	Test conditions	Min	Typ	Max	Unit
I_{lim}	Drain current limit	$V_{IN} = 5\text{ V}$; $V_{DS} = 13\text{ V}$	6	8.5	12	A
t_{dlim}	Step response current limit	$V_{IN} = 5\text{ V}$; $V_{DS} = 13\text{ V}$		10		μ s
T_{jsh}	Overtemperature shutdown		150	175	200	$^{\circ}\text{C}$
T_{jrs}	Overtemperature reset		135			$^{\circ}\text{C}$
I_{gf}	Fault sink current	$V_{IN} = 5\text{ V}$; $V_{DS} = 13\text{ V}$; $T_j = T_{jsh}$	10	15	20	mA
E_{as}	Single pulse avalanche energy	Starting $T_j = 25\text{ °C}$; $V_{DD} = 24\text{ V}$; $V_{IN} = 5\text{ V}$; $R_{gen} = R_{IN\ MINn} = 220\ \Omega$; $L = 24\text{ mH}$	100			mJ

4.2 Electrical characteristics curves for low-side switches

Figure 18. Static drain source on resistance

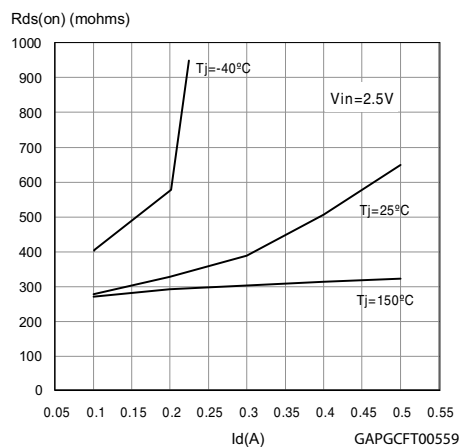

Figure 19. Derating curve

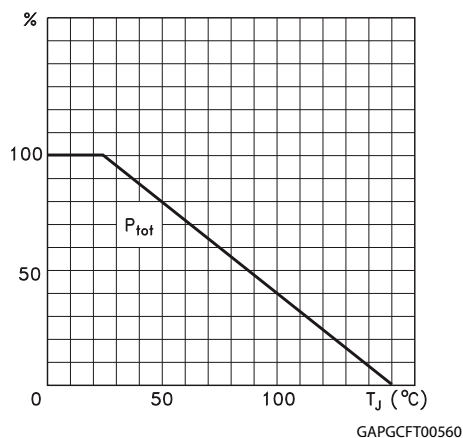

Figure 20. Transconductance

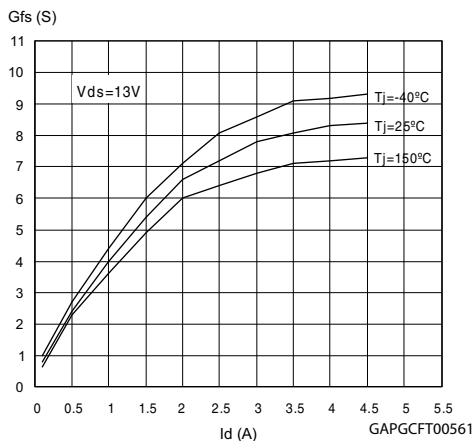

Figure 21. Transfer characteristics

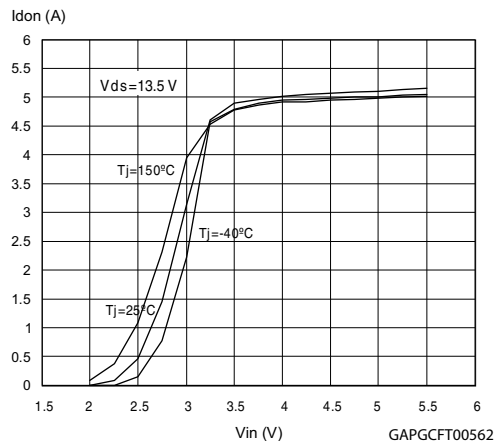

Figure 22. Input voltage vs input charge

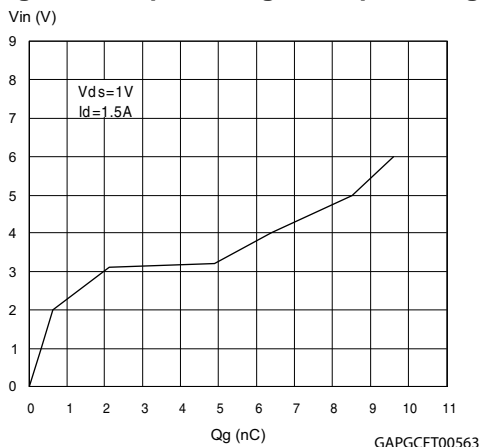
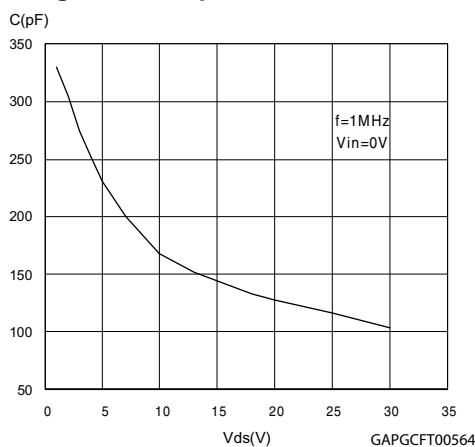
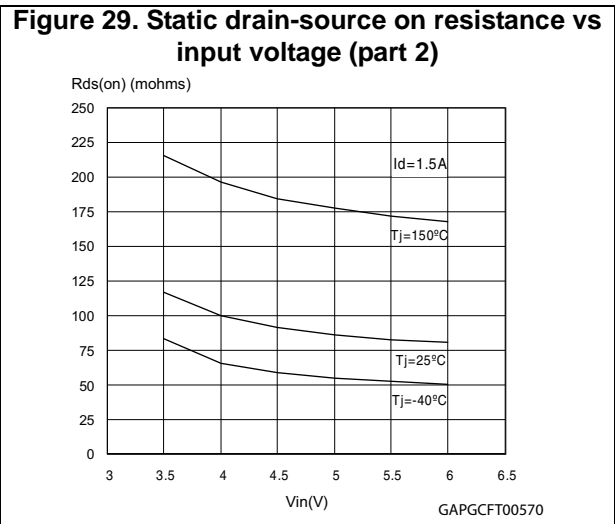
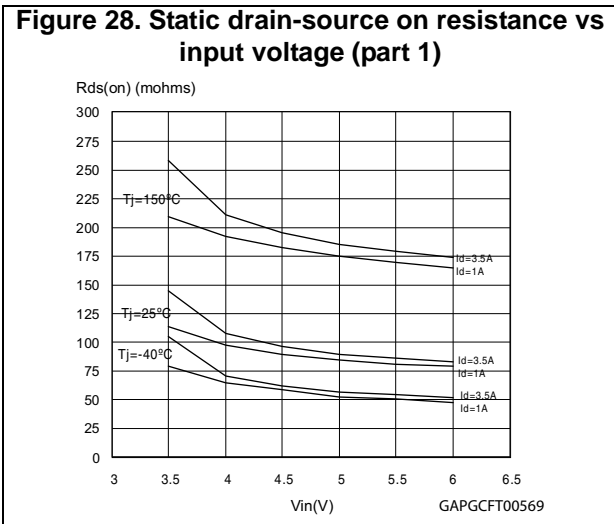
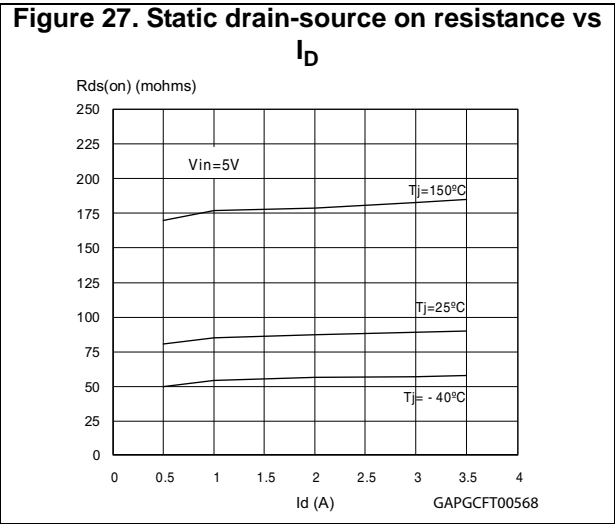
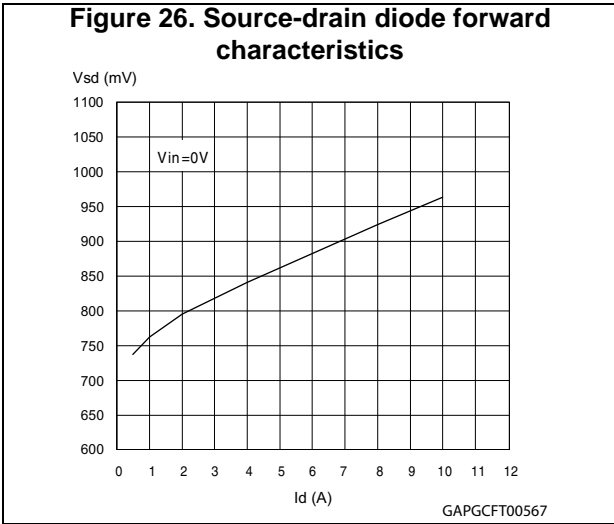
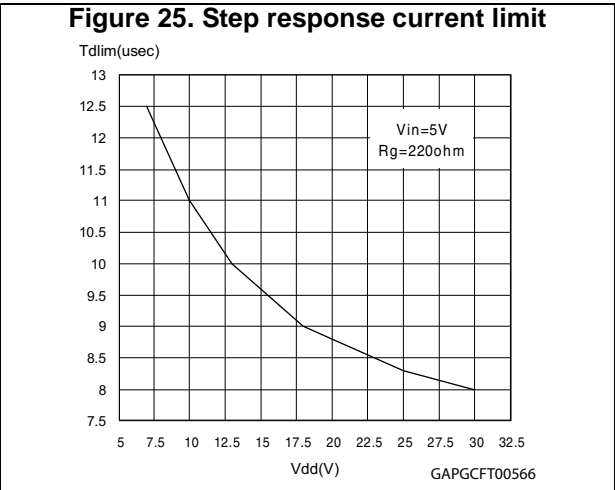
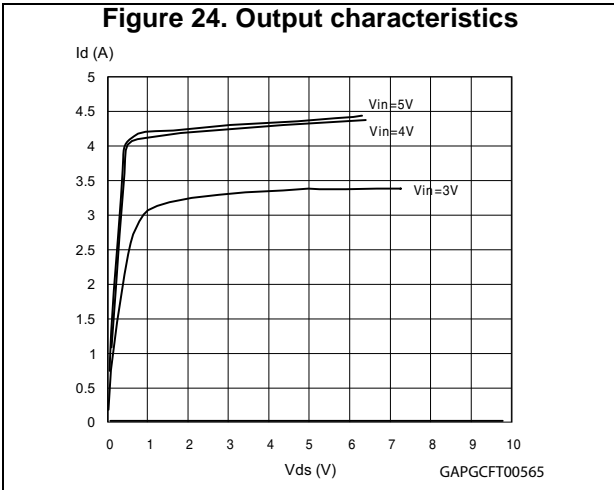
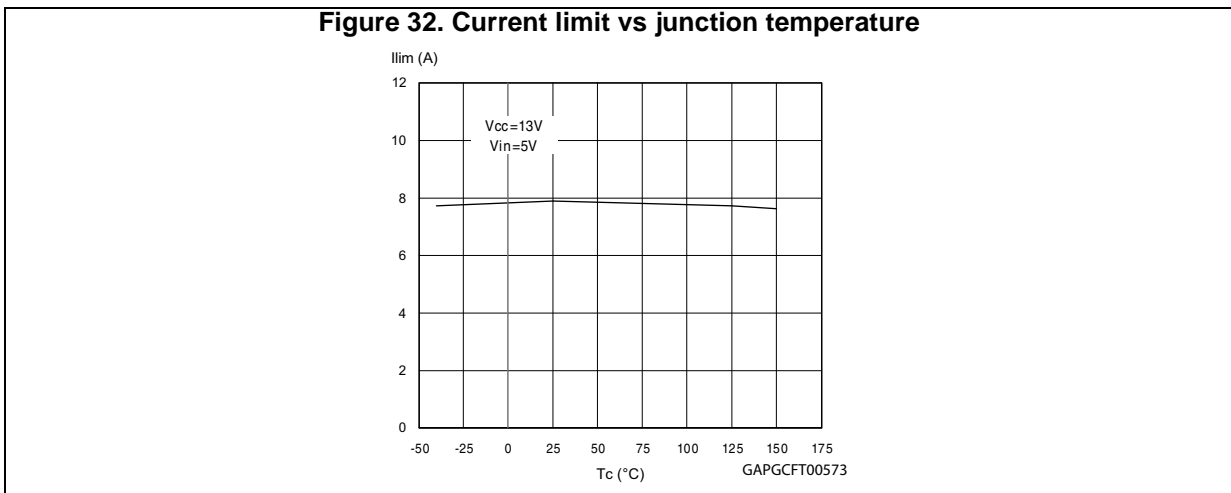
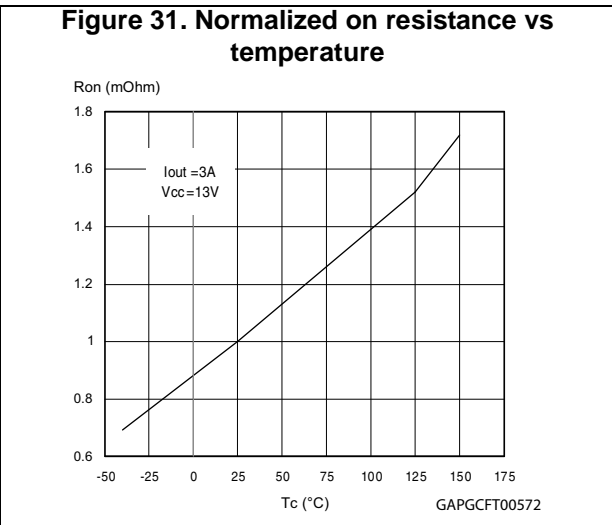
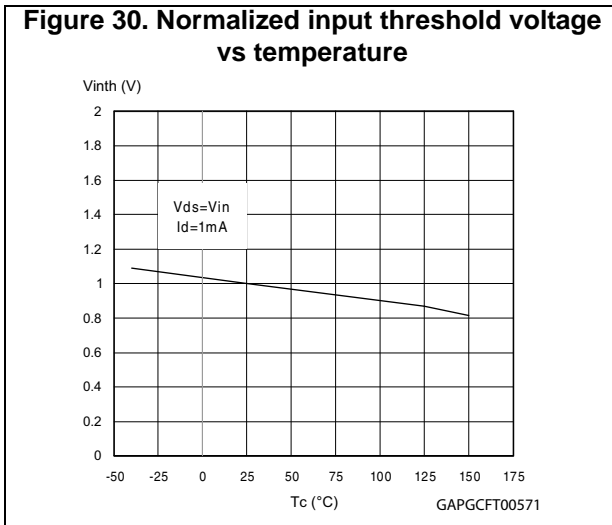

Figure 23. Capacitance variations







5 Application information

Figure 33. Typical application schematic

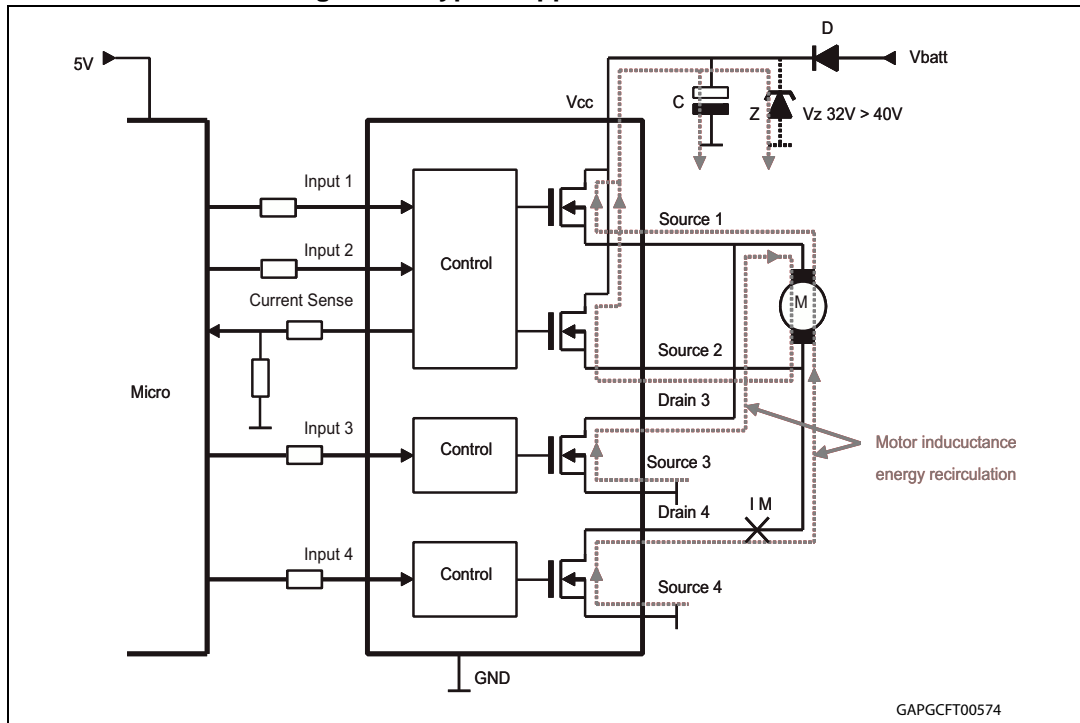

Note: Mostly motor bridge drivers use a reverse battery protection diode (D) inside supply rail. This diode prevents a reverse current flow back to Vbatt in case the bridge gets disabled via the logic inputs while motor inductance still carries energy. In order to prevent a hazardous overvoltage at circuit supply terminal (Vcc), a blocking capacitor (C) is needed to limit the voltage overshoot. As basic orientation, 50 μ F per 1 A load current is recommended. In alternative, also a Zener protection (Z) is suitable. Even if a reverse polarity diode is not present, it is recommended to use a capacitor or zener at Vcc because a similar problem appears in case supply terminal of the module has intermittent electrical contact to the battery or gets disconnected while motor is operating.

Figure 34. Recommended motor operation

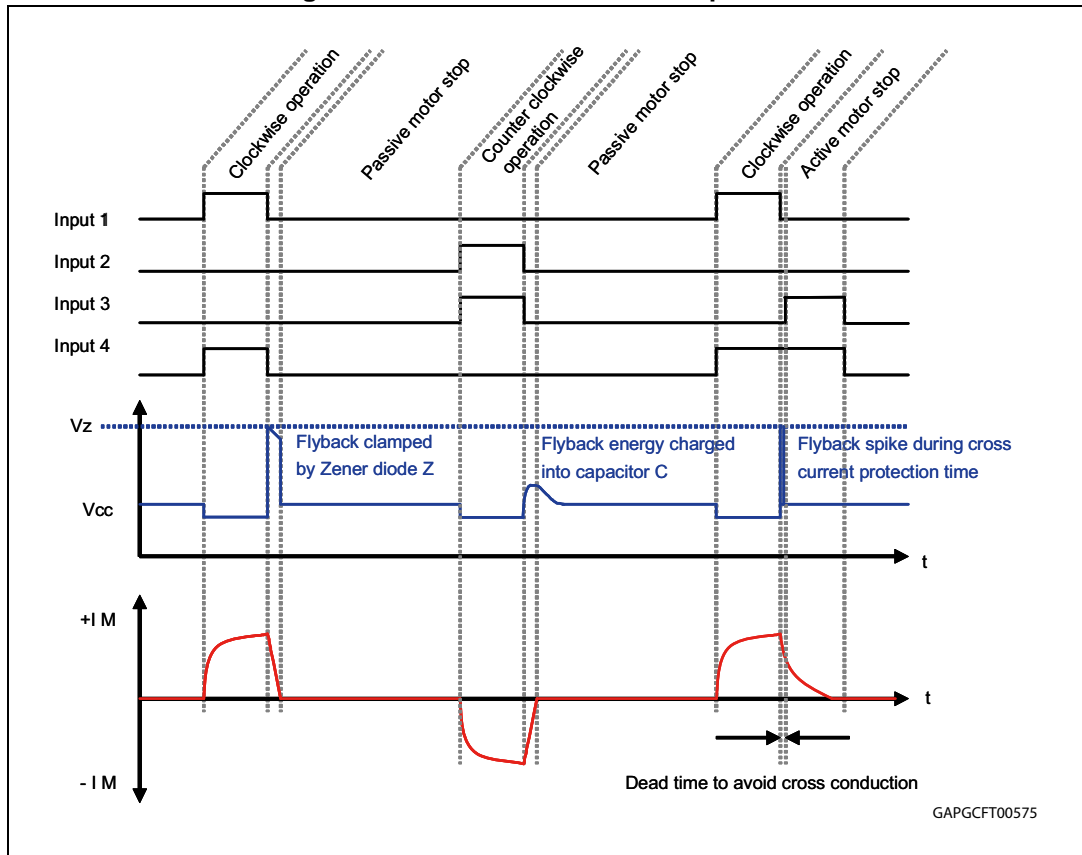

GAPGCF00575

Figure 35. Waveforms

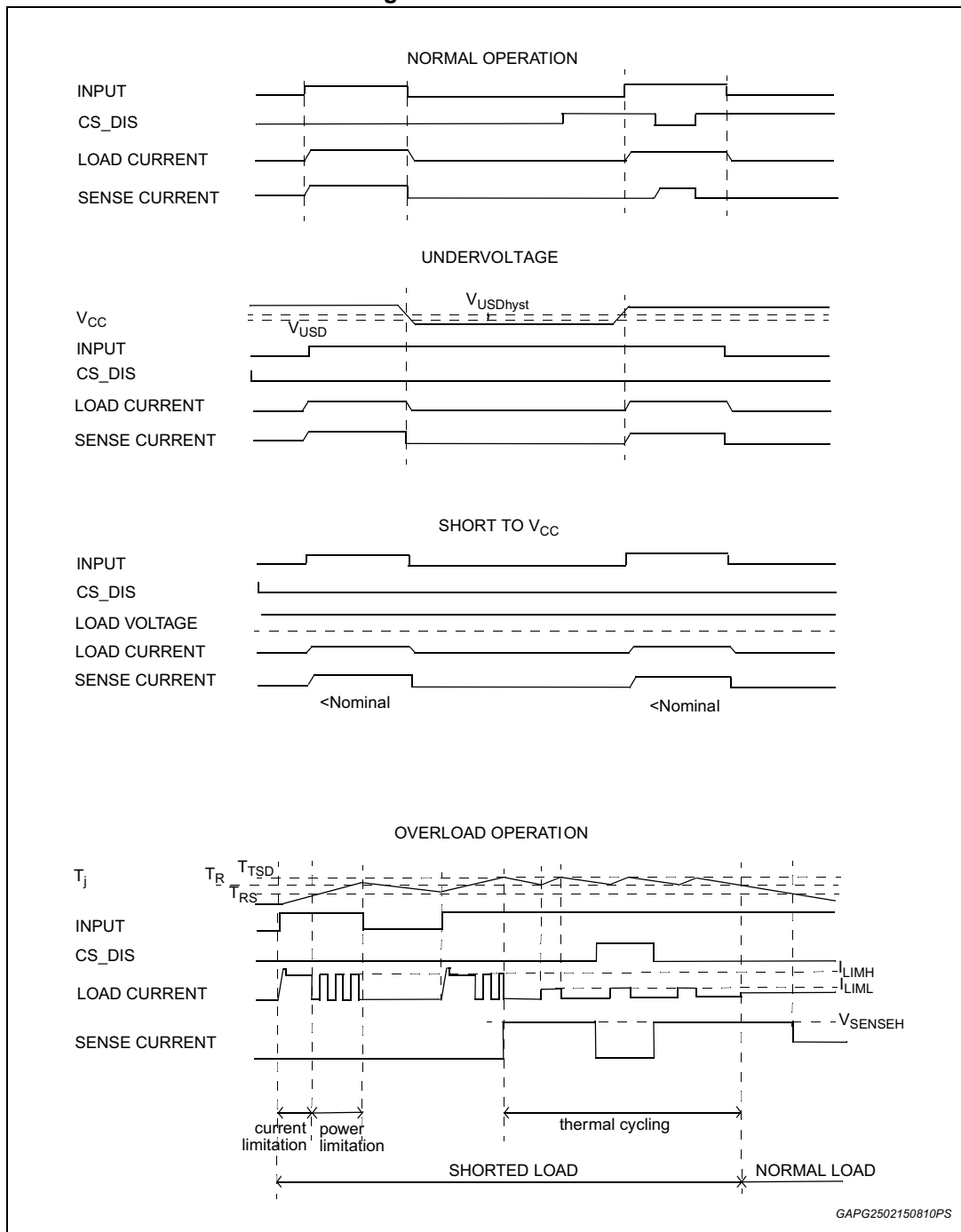

5.1 Maximum demagnetization energy ($V_{CC} = 13.5\text{ V}$)

Figure 36. Maximum turn off current versus load inductance

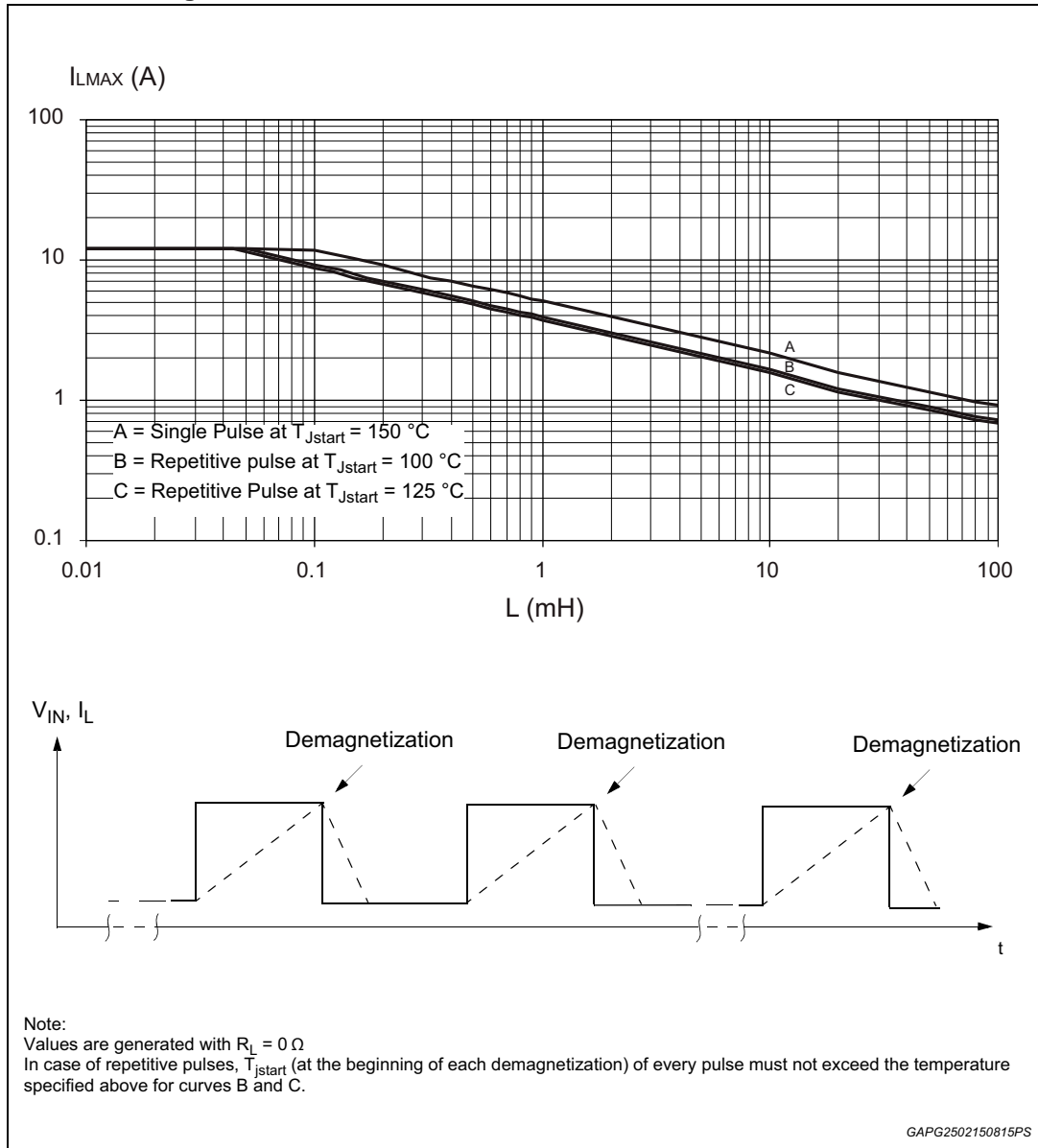

6 Package and thermal data

6.1 SO-28 thermal data

Figure 37. SO-28 PC board

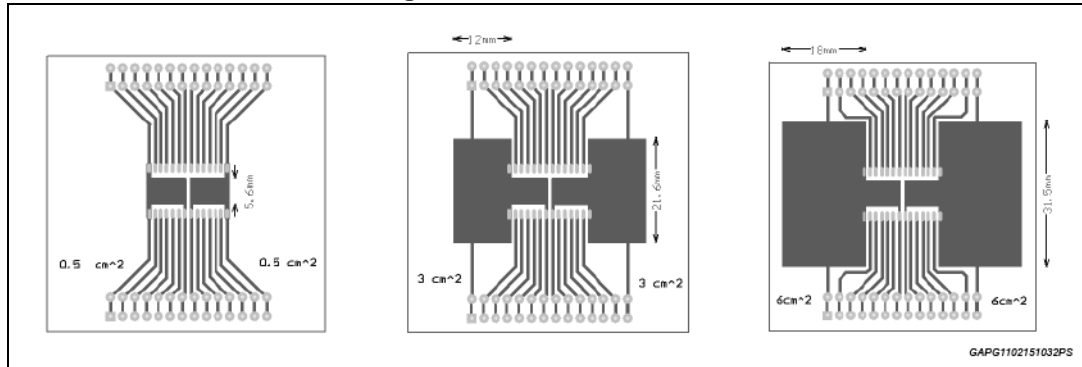

Note: Layout condition of R_{th} and Z_{th} measurements (PCB FR4 area= 58 mm x 58 mm, PCB thickness = 2 mm, Cu thickness = 35 mm, Copper areas: from minimum pad layout to 16 cm²).

Figure 38. Chipset configuration

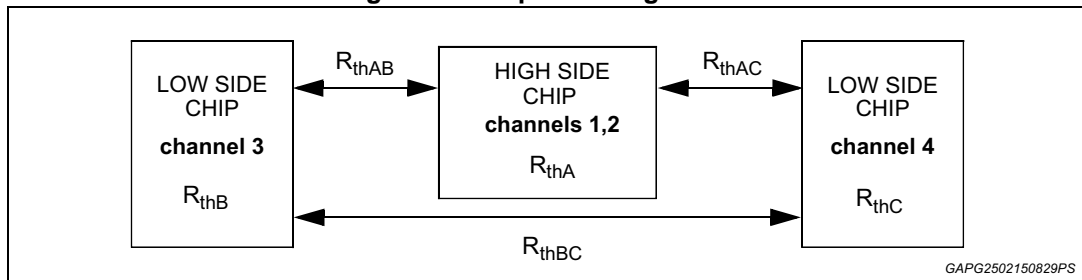
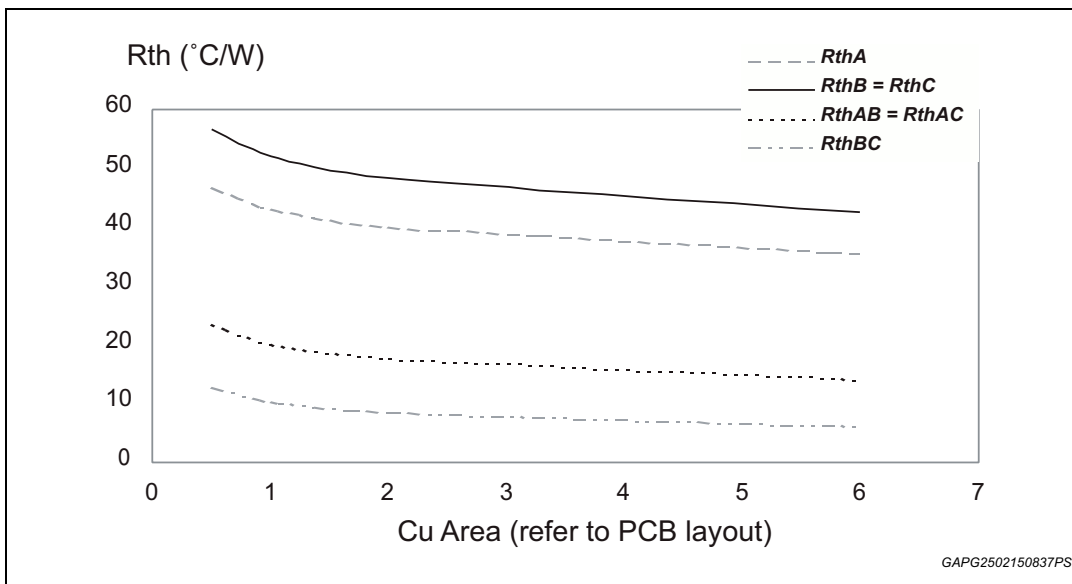

Figure 39. Auto and mutual Rthj-amb vs PCB copper area in open box free air condition



Note: See Figure 38. For more detailed information see Table 17 and Table 18.

Table 17. Thermal calculations in clockwise and anti-clockwise operation in steady-state mode

HS ₁	HS ₂	LS ₃	LS ₄	T _{jHS12}	T _{jLS3}	T _{jLS4}
ON	OFF	OFF	ON	$P_{dHS1} \times R_{thHS} + P_{dLS4} \times R_{thHLSL} + T_{amb}$	$P_{dHS1} \times R_{thHLSL} + P_{dLS4} \times R_{thLSL} + T_{amb}$	$P_{dHS1} \times R_{thHLSL} + P_{dLS4} \times R_{thLS} + T_{amb}$
OFF	ON	ON	OFF	$P_{dHS2} \times R_{thHS} + P_{dLS3} \times R_{thHLSL} + T_{amb}$	$P_{dHS2} \times R_{thHLSL} + P_{dLS3} \times R_{thLS} + T_{amb}$	$P_{dHS2} \times R_{thHLSL} + P_{dLS3} \times R_{thLSL} + T_{amb}$

Table 18. Thermal resistances definitions

Parameter	Definition
R _{thHS} = R _{thHS1} = R _{thHS2}	High-side chip thermal resistance junction to ambient (HS ₁ or HS ₂ in ON-state)
R _{thLS} = R _{thLS3} = R _{thLS4}	Low-side chip thermal resistance junction to ambient
R _{thHLSL} = R _{thHS1LS4} = R _{thHS2LS3}	Mutual thermal resistance junction to ambient between high-side and low-side chips
R _{thLSLS} = R _{thLS3LS4}	Mutual thermal resistance junction to ambient between low-side chips

Note: Values dependent on PCB heatsink area.

Table 19. Single pulse thermal impedance definitions

Parameter	Definition
Z_{thHS}	High-side chip thermal impedance junction to ambient
$Z_{thLS} = Z_{thLS3} = Z_{thLS4}$	Low-side chip thermal impedance junction to ambient
$Z_{thHLSL} = Z_{thHS12LS3} = Z_{thHS12LS4}$	Mutual thermal impedance junction to ambient between high-side and low-side chips
$Z_{thLSSL} = Z_{thLS3LS4}$	Mutual thermal impedance junction to ambient between low-side chips

Note: Values dependent on PCB heatsink area.

Table 20. Thermal calculations in transient mode

Parameter	Definition
T_{jHS12}	$Z_{thHS} \times P_{dHS12} + Z_{thHLSL} \times (P_{dLS3} + P_{dLS4}) + T_{amb}$
T_{jLS3}	$Z_{thHLSL} \times P_{dHS12} + Z_{thLS} \times P_{dLS3} + Z_{thLSSL} \times P_{dLS4} + T_{amb}$
T_{jLS4}	$Z_{thHLSL} \times P_{dHS12} + Z_{thLSSL} \times P_{dLS3} + Z_{thLS} \times P_{dLS4} + T_{amb}$

Note: Calculation is valid in any dynamic operating condition. Pd values set by user.

Figure 40. SO-28 HSD thermal impedance junction ambient single pulse

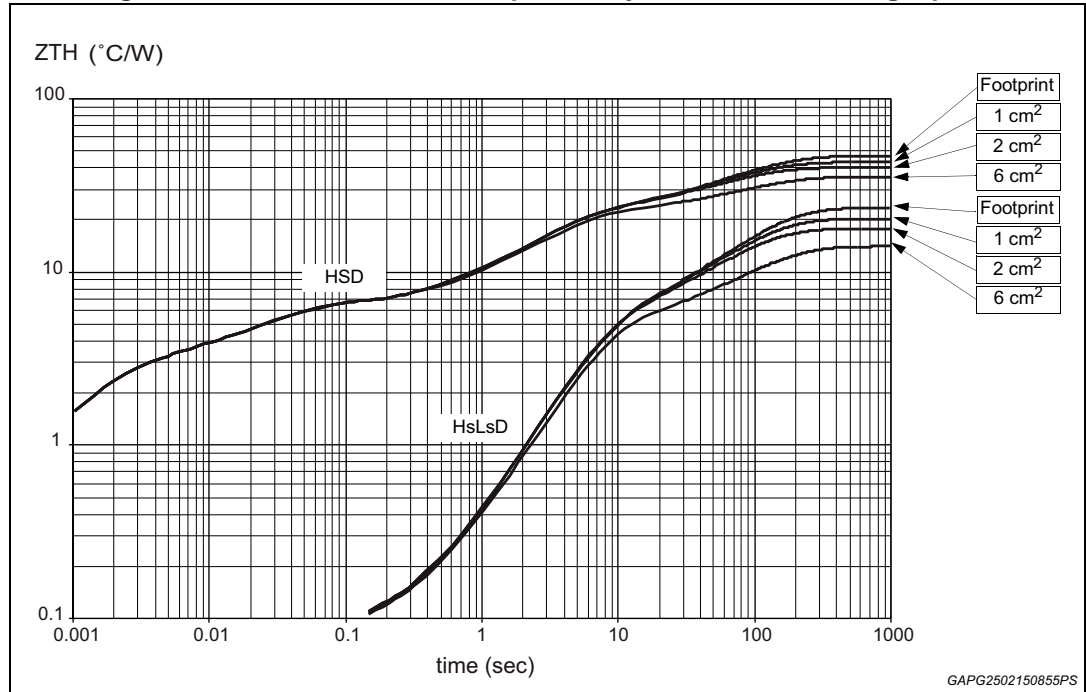
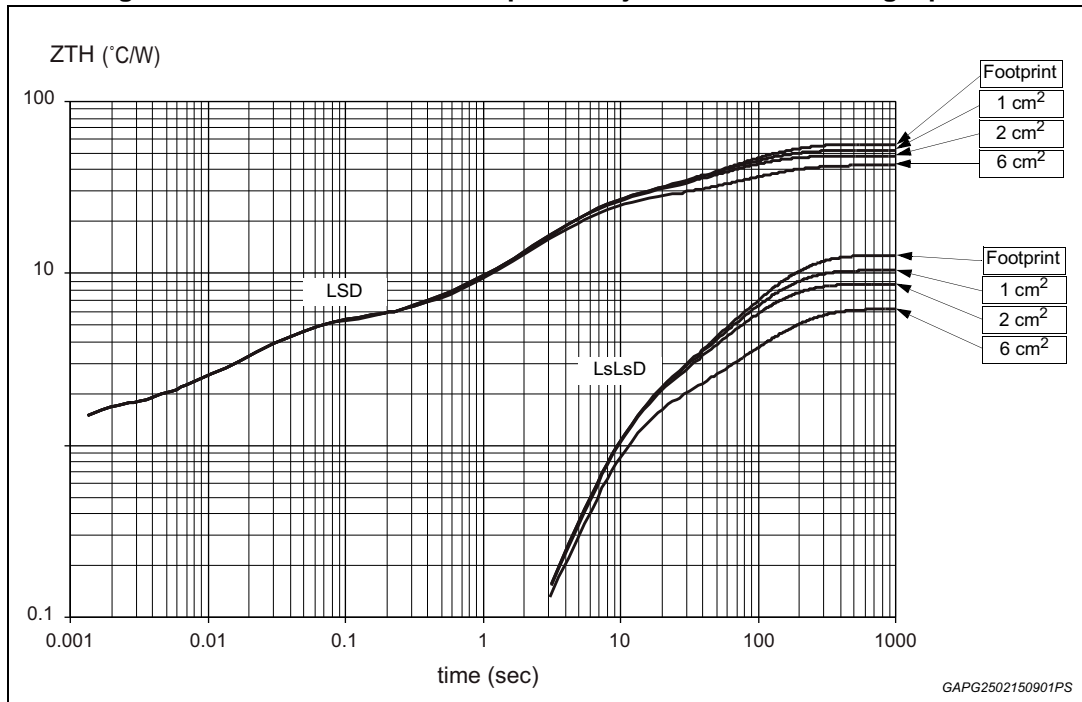

Figure 41. SO-28 LSD thermal impedance junction ambient single pulse



Equation 1: pulse calculation formula

$$Z_{TH\delta} = R_{TH} \cdot \delta + Z_{THtp}(1 - \delta)$$

where $\delta = t_p/T$

Figure 42. Thermal fitting model of an H-bridge in SO-28

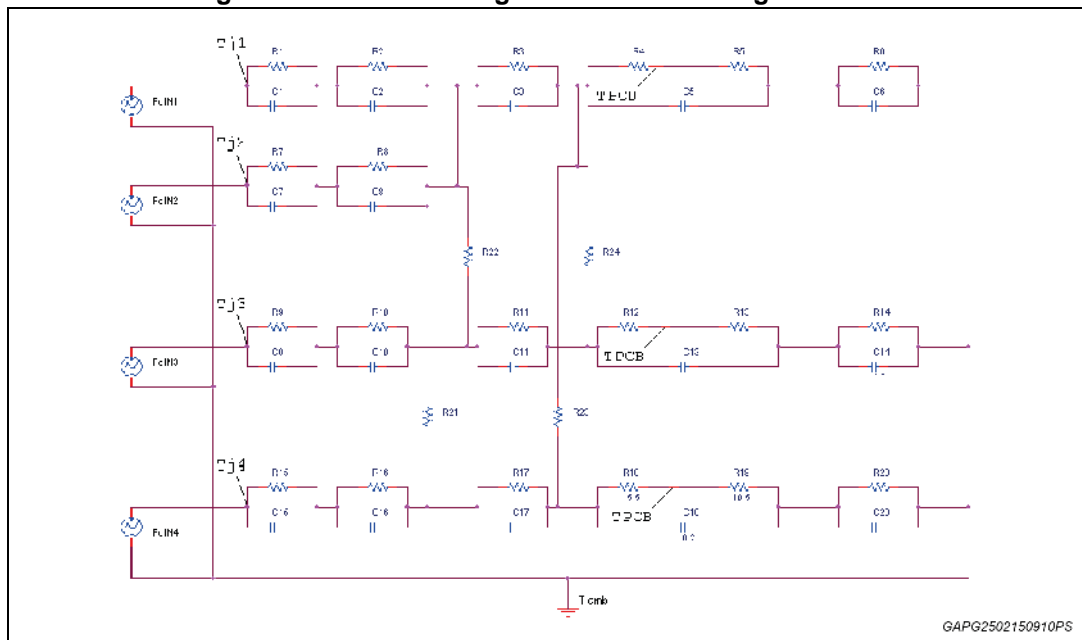

Table 21. Thermal parameters

Area/island (cm ²)	Footprint	1	2	6
R1 = R7 (°C/W)	1			
R2 = R8 (°C/W)	1.8			
R3 = R11 = R17 (°C/W)	3.5			
R4 (°C/W)	13.5			
R5 = R13 = R19 (°C/W)	10.5			
R6 = R14 = R20 (°C/W)	62.28	52.28	44.28	32.28
R9 = R15 (°C/W)	0.24			
R10 = R16 (°C/W)	1.2			
R12 (°C/W)	15.2			
R18 (°C/W)	15.5			
R21 = R22 = R23 (°C/W)	150			
R24 (°C/W)	150	52.28	44.28	32.28
C1 = C7 (W·s/°C)	0.0008			
C2 = C8 (W·s/°C)	0.001			
C3 = C11 = C17 (W·s/°C)	0.008			
C5 = C13 = C19 (W·s/°C)	0.2			
C6 = C14 = C20 (W·s/°C)	1.6	1.61	1.7	3.25
C9 = C15 (W·s/°C)	0.00015			
C10 = C16 (W·s/°C)	0.0005			

Note: A blank space means that the value is the same as the previous one.

7 Package information

In order to meet environmental requirements, ST offers these devices in different grades of ECOPACK® packages, depending on their level of environmental compliance. ECOPACK® specifications, grade definitions and product status are available at: www.st.com. ECOPACK® is an ST trademark.

7.1 SO-28 package information

Figure 43. SO-28 package outline

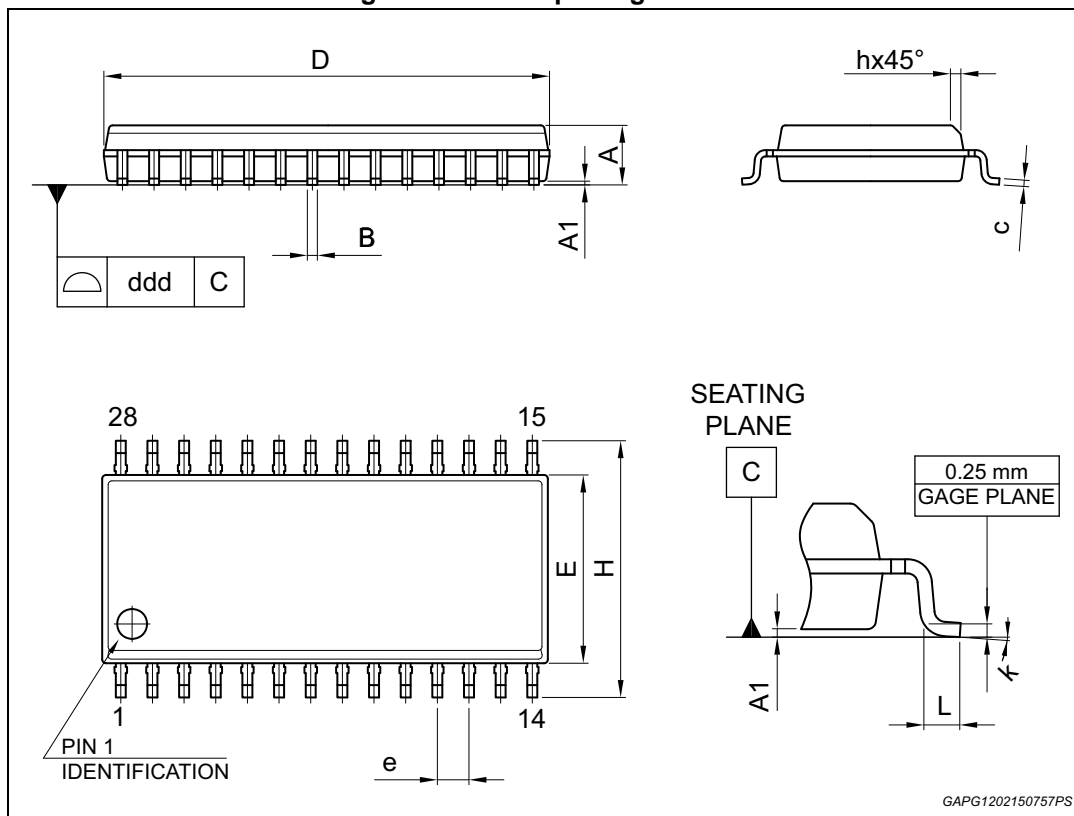

Table 22. SO-28 mechanical data

Ref.	Dimensions		
	Millimeters		
	Min.	Typ.	Max.
A	2.35		2.65
A1	0.10		0.30
B	0.33		0.51
C	0.23		0.32
D ⁽¹⁾	17.70		18.10

Table 22. SO-28 mechanical data

Ref.	Dimensions		
	Millimeters		
	Min.	Typ.	Max.
E	7.40		7.60
e		1.27	
H	10.0		10.65
h	0.25		0.75
L	0.40		1.27
k	0°		8°
ddd			0.10

1. Dimension "D" does not include mold flash, protrusions or gate burrs.
Mold flash, protrusions or gate burrs shall not exceed 0.15mm per side.

7.2 SO-28 packing information

Figure 44. SO-28 tube shipment (no suffix)

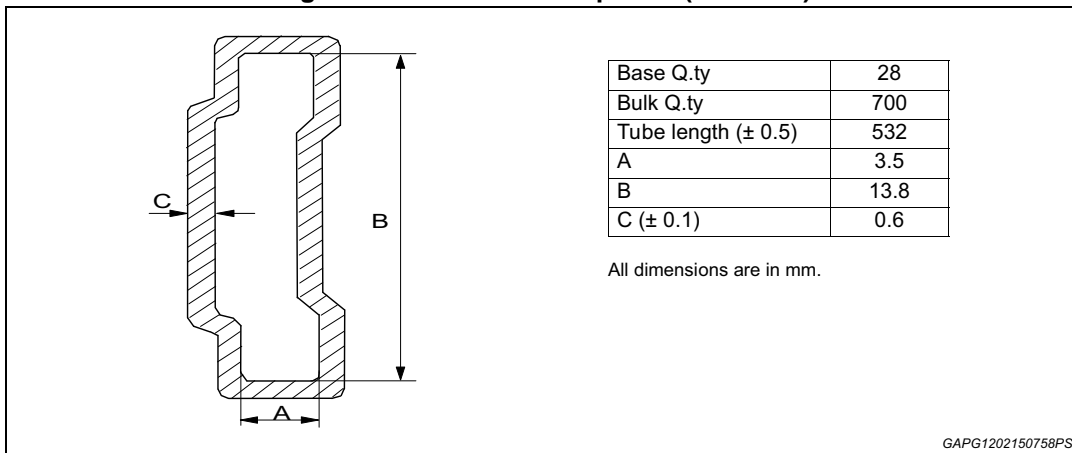

Figure 45. Reel for SO-28

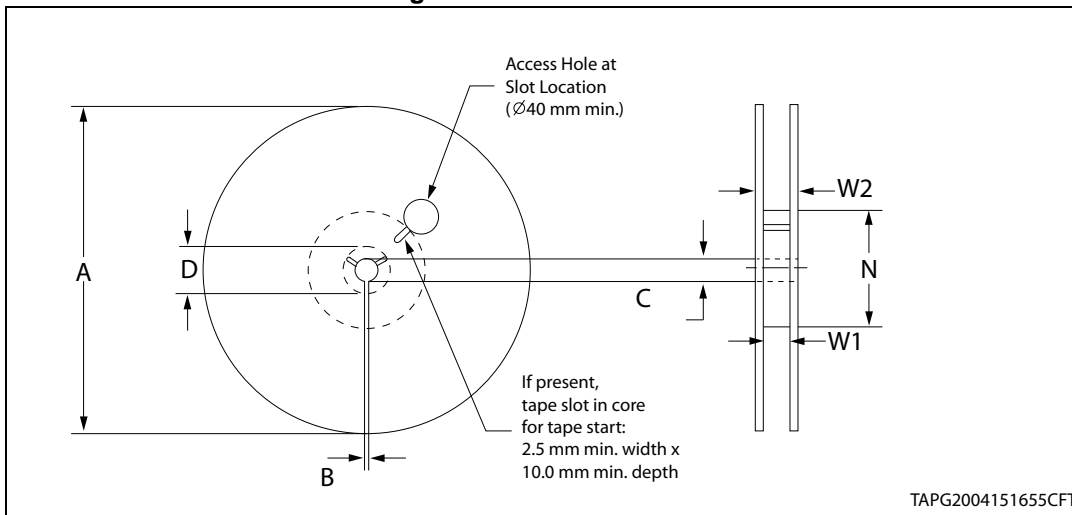

Table 23. Reel dimensions

Description	Value ⁽¹⁾
Base quantity	1000
Bulk quantity	1000
A (max)	330
B (min)	1.5
C (+0.5, -0.2)	13
D (min)	20.2
N	100
W1 (+2/ -0)	24.4
W2 (max)	30.4

1. All dimensions are in mm.

Figure 46. SO-28 carrier tape

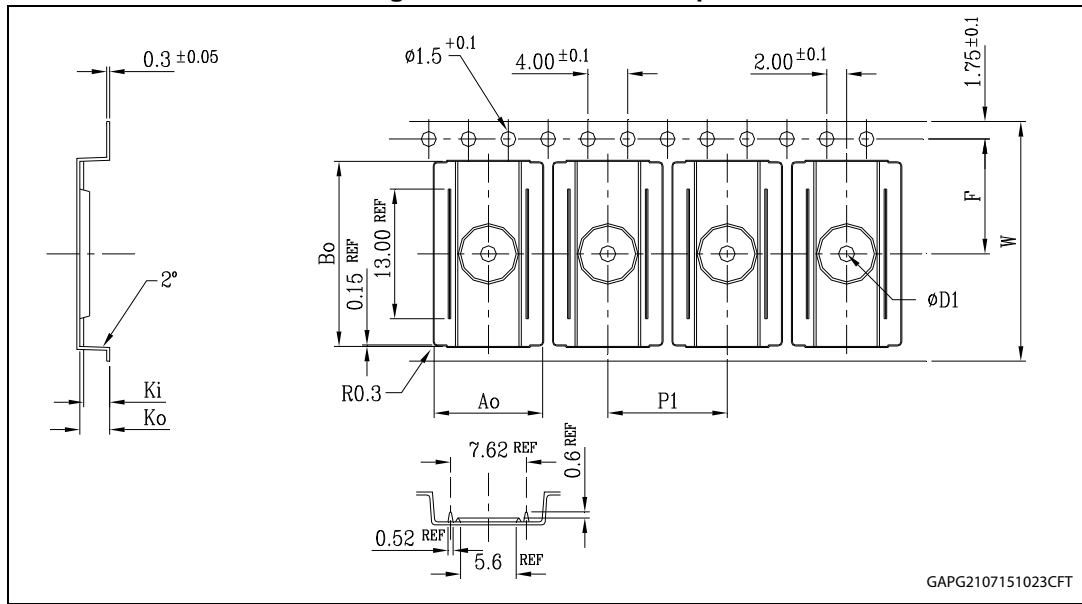
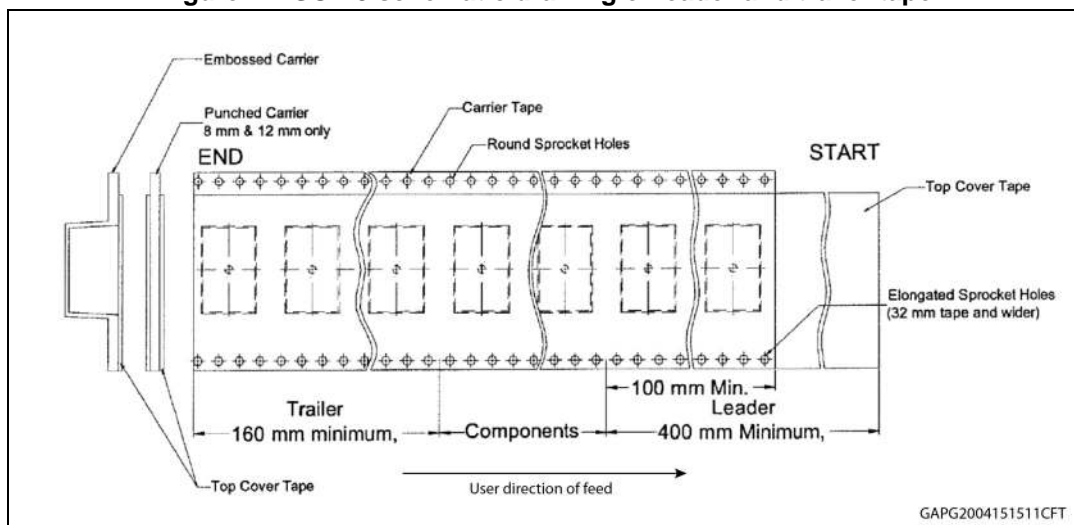

Table 24. SO-28 carrier tape dimensions

Description	Value ⁽¹⁾
A_0	10.90 ± 0.1
B_0	18.55 ± 0.1
K_0	3.0 ± 0.1
K_1	2.6 ± 0.1
F	11.5 ± 0.1
P_1	12.0 ± 0.1
$D1$	1.5 ± 0.1
W	24.0 ± 0.3

1. All dimensions are in mm.

Figure 47. SO-28 schematic drawing of leader and trailer tape



8 Order codes

Table 25. Device summary

Package	Order codes	
	Tube	Tape and reel
SO-28	VN5770AKP-E	VN5770AKPTR-E

9 Revision history

Table 26. Document revision history

Date	Revision	Changes
11-Nov-2010	1	Initial release.
04-Jan-2012	2	<i>Table 9: Current sense (8V<VCC<16V)</i> - K ₀ values modified
20-Feb-2012	3	Update <i>Figure 2: Configuration diagram (top view)</i> and <i>Figure 33: Typical application schematic</i>
02-Oct-2012	4	<i>Table 9: Current sense (8V<VCC<16V)</i> : – K ₀ : updated values
23-Sep-2013	5	Updated Disclaimer Fixed order code value on the cover page and <i>Table 25: Device summary</i>
25-Feb-2015	6	Updated: – <i>Section 7.1: SO-28 package information</i> ; – Tape dimensions in <i>Figure 8: Order codes on page 35</i> .
21-Jul-2015	7	Updated <i>Section 7.2: SO-28 packing information</i>

IMPORTANT NOTICE – PLEASE READ CAREFULLY

STMicroelectronics NV and its subsidiaries ("ST") reserve the right to make changes, corrections, enhancements, modifications, and improvements to ST products and/or to this document at any time without notice. Purchasers should obtain the latest relevant information on ST products before placing orders. ST products are sold pursuant to ST's terms and conditions of sale in place at the time of order acknowledgement.

Purchasers are solely responsible for the choice, selection, and use of ST products and ST assumes no liability for application assistance or the design of Purchasers' products.

No license, express or implied, to any intellectual property right is granted by ST herein.

Resale of ST products with provisions different from the information set forth herein shall void any warranty granted by ST for such product.

ST and the ST logo are trademarks of ST. All other product or service names are the property of their respective owners.

Information in this document supersedes and replaces information previously supplied in any prior versions of this document.

© 2015 STMicroelectronics – All rights reserved

