

DC-DC Converter DATA Sheet

MPDRX301S/MPDRX302S

1. Features

- Ultra high-speed response is realized by using original ripple detecting control.
- Up to 13A output current, non-isolated POL.
- Wide adjustable output voltage range by connecting external resistance (0.8V to 3.63V).
- Wide operating temperature(-40 °C to +85 °C).
- UVLO function, ON/OFF function, Output voltage sense function, Over-current function and, PowerGood signal output function are built in.



Product line up

Output Voltage	
1.6~3.63V	0.8~1.65V
MPDRX301S	MPDRX302S



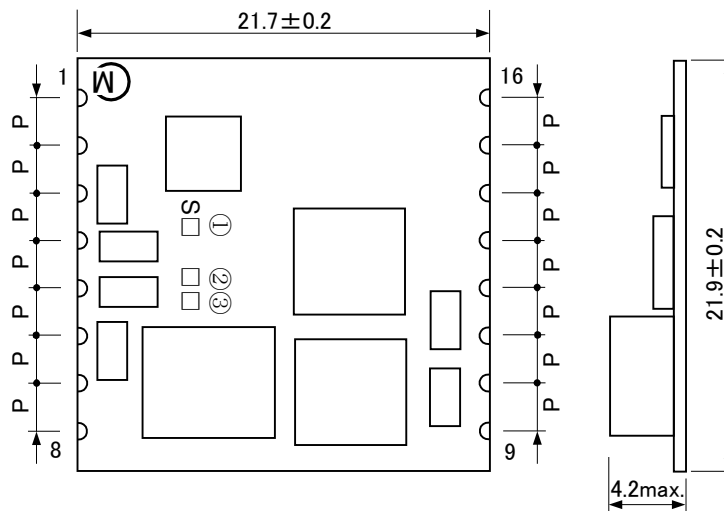

2. Appearance, Dimensions



$P=2.54 \pm 0.2\text{mm}$
Tolerance is not accumulated.

[unit : mm]

Marking

- (1) Pin No.1 Marking / MFG ID 
- (2) Parts No.  
- ① P : MPDRX301S
Q : MPDRX302S
- (3) Lot No.  
- ② Production Year
- ③ Production Month (1,2,3,...9,O,N,D)

Flux may expand on PCB and attach onto the area where the marking is printed with laser.
In the case the marking become darker in color since flux is unreflecting.
It may be a little hard to read, however, the marking is not deleted nor blurred.

Note:

1. This datasheet is downloaded from the website of Murata Manufacturing co., Ltd. Therefore, it's specifications are subject to change or our products in it may be discontinued without advance notice. Please check with our sales representatives or product engineers before ordering.
2. This datasheet has only typical specifications because there is no space for detailed specifications. Therefore, please approve our product specifications or transact the approval sheet for product specifications before ordering.

Pin Number and Function

Pin No.	Symbol	Function
1	SENSE	Output voltage sense
2,3	Vout	Output
4,5,11,12	GND	GND
8,	FT	Output trim
7,	VAR	Output voltage adjustment
9,10	Vin	Input
6,	SS	Soft start
14	N.C.	This pin must be left open.
15	POW-GOOD1	Power Good
16	POW-GOOD2	Power Good
13	ON/OFF	Remote ON/OFF

3. Block Diagram

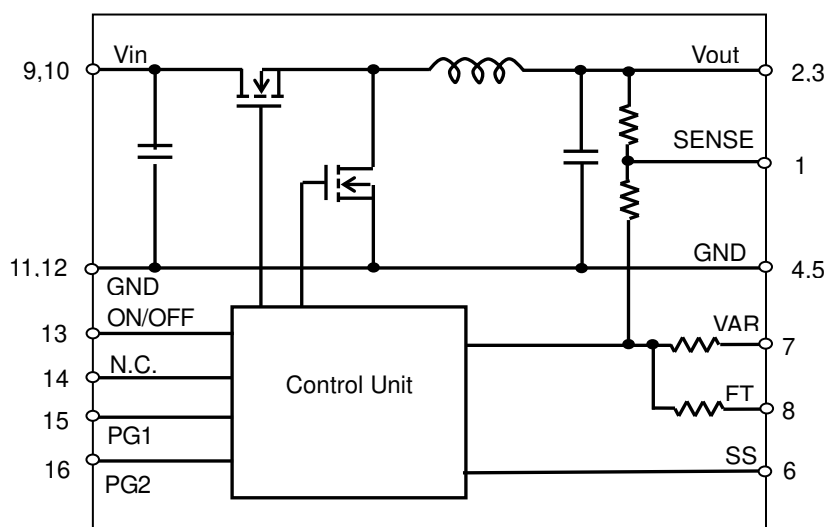

4. Environmental Conditions

4.1. Operating Temperature Range	-40°C ~ +85°C
4.2. Storage Temperature Range	-40°C ~ +85°C
4.3. Operating Humidity Range	20% ~ 85% (No water condenses in any cases.)
4.4. Storage Humidity Range	10% ~ 95% (No water condenses in any cases.)

5. Absolute Maximum Rating

Item	Unit	Absolute Rating	Remarks
Minimum Input Voltage	V	0	
Maximum Input Voltage	V	13.2	
POW-GOOD Pin Voltage			
	Time	Continuous	
		10ms	Voltage slew rate 1.0V/10μs
ON/OFF Pin Voltage	V	7	However, below Vin
Maximum POW-GOOD Sink Current	mA	15	Total of PG1 and PG2

※No voltage, no matter how instantaneous, shall be applied beyond the absolute maximum voltage rating to this product. If you apply any voltage over this limit the product characteristics will deteriorate or the product itself will be destroyed. Even though it may continue operating for a while after the over-voltage event, its life will likely be shortened significantly. Reliability and life of the module may degrade similarly if the maximum operating voltage rating is continuously exceeded. This product is designed to operate within the maximum operating voltage rating specification.

⚠ Note:

- This datasheet is downloaded from the website of Murata Manufacturing co., Ltd. Therefore, it's specifications are subject to change or our products in it may be discontinued without advance notice. Please check with our sales representatives or product engineers before ordering.
- This datasheet has only typical specifications because there is no space for detailed specifications. Therefore, please approve our product specifications or transact the approval sheet for product specifications before ordering.

6. Characteristics

6. 1. Electrical Characteristics (Ta=25 °C)
(1) MPDRX301S

Item	Symbol	Condition	Value			Unit	
			Min.	Typ.	Max.		
Input Voltage Range	Vin		6.2	9.6	13.2	V	
Rising UVLO Threshold	UVLOr	Vin Increasing	-	5.25	-	V	
Falling UVLO Threshold	UVLOf	Vin Decreasing	-	5.0	-	V	
Output Voltage Adjustable Range	Vout	FT=Short	1.6	-	3.63	V	
Output Voltage Tolerance	Vo tol	Over Vin, Io, Temperature Range Vin=6.2~13.2V Rset=1% tolerance, FT=Short	-2.0	-	+2.0	%Vo	
Output Current	Iout	See the thermal derating curve in section 6.2.	0	-	13	A	
Ripple Voltage	Vrpl	Vout =3.3V, Iout=0~13A BW=20MHz, Cout=100μF	-	20	50	mV(pp)	
Efficiency	EFF	Vin =9.6V, Iout=10A	Vout=3.3V	-	91	-	%
			Vout=2.5V	-	88	-	
			Vout=1.8V	-	86	-	
Operating Frequency	Frq	Vin =9.6V, Vout=3.3V	-	750	-	kHz	
		Vin =9.6V, Vout=1.8V	-	550	-		
Power Good	PWGL	Power Good low threshold	-	0.87Vo	-	V	
	PWGH	Power Good high threshold	-	1.13Vo	-		
ON/OFF pin High Voltage	VIH	ON/OFF pin is pulled up to Vin inside of the DC-DC converter. If ON/OFF pin is left open the DC-DC converter shall be "ON". This pin will be pulled down to GND inside the DC-DC converter when UVLO events occur. Please do NOT connect this pin to power supply with low impedance line, so as not to damage the converter.					
ON/OFF pin Low Voltage	VIL	If ON/OFF pin is connected to GND, the DC-DC Converter shall be "OFF".	OFF	0	-	1.0	V
Short Circuit Protection	SCP	If output is shorted to GND, DC-DC converter will shut down. After reject the abnormal mode, DC-DC converter will restart by re-inputting Vin or toggling ON/OFF pin.	13	23	-	A	
External Input Capacitor	Cin	When input voltage is ideal voltage source	20	-	5000	μF	
External Output Capacitor	Cout	When input voltage is ideal voltage source	100	-	1000	μF	
Ramp Rate	Tr	Vo=10%~90%, SS=Open	1	2	5	msec	
Rising Overshoot	Vover		-	0	+10	%	
Startup Delay	Td	ON/OFF High : Vin Low → High Vo=10%, SS= Open	0.1	0.5	2	msec	
RC Startup Delay	Trcd	Vin High : ON/OFF Low → High/Open Vo=10%	0.1	0.4	2	msec	

⚠ Note:

1. This datasheet is downloaded from the website of Murata Manufacturing co., Ltd. Therefore, it's specifications are subject to change or our products in it may be discontinued without advance notice. Please check with our sales representatives or product engineers before ordering.
2. This datasheet has only typical specifications because there is no space for detailed specifications. Therefore, please approve our product specifications or transact the approval sheet for product specifications before ordering.

(2) MPDRX302S

Item	Symbol	Condition	Value			Unit	
			Min.	Typ.	Max.		
Input Voltage Range	Vin		6.2	9.6	13.2	V	
Rising UVLO Threshold	UVLOr	Vin Increasing	-	5.25	-	V	
Falling UVLO Threshold	UVLOf	Vin Decreasing	-	5.0	-	V	
Output Voltage Adjustable Range	Vout	FT=Open	0.8	-	0.95	V	
		FT=Short	0.95	-	1.65		
Output Voltage Tolerance	Vo tol	Over Vin, Io, Temperature Range Vin=6.2~13.2V Rset=1% tolerance	-2.0	-	+2.0	%Vo	
Output Current	Iout	See the thermal derating curve in section 6.2.	0	-	13	A	
Ripple Voltage	Vrpl	Vout =1.65V, Iout=0~13A BW=20MHz, Cout=100μF	-	15	50	mV(pp)	
Efficiency	EFF	Vin =9.6V, Iout=10A	Vout=1.5V	-	85	-	%
			Vout=1.2V	-	83	-	
			Vout=0.8V	-	79	-	
Operating Frequency	Frq	Vin =9.6V, Vout=1.5V	-	650	-	kHz	
		Vin =9.6V, Vout=0.8V	-	450	-		
Power Good	PWGL	Power Good low threshold	-	0.87Vo	-	V	
	PWGH	Power Good high threshold	-	1.13Vo	-		
ON/OFF pin High Voltage	VIH	ON/OFF pin is pulled up to Vin inside of the DC-DC converter. If ON/OFF pin is left open, the DC-DC converter shall be "ON". This pin will be pulled down to GND inside the DC-DC converter when UVLO events occur. Please do NOT connect this pin to power supply with low impedance line, so as not to damage the converter.					
ON/OFF pin Low Voltage	VIL	If ON/OFF pin is connected to GND, the DC-DC Converter shall be "OFF".	OFF	0	-	1.0	V
Short Circuit Protection	SCP	If output is shorted to GND, DC-DC converter will shut down. After reject the abnormal mode, DC-DC converter will restart by re-inputting Vin or toggling ON/OFF pin.		13	23	-	A
External Input Capacitor	Cin	When input voltage is ideal voltage source		20	-	5000	μF
External Output Capacitor	Cout	When input voltage is ideal voltage source		100	-	1000	μF
Ramp Rate	Tr	Vo=10%~90%, SS=Open		1	2	5	msec
Rising Overshoot	Vover			-	0	+10	%
Startup Delay	Td	ON/OFF High : Vin Low → High Vo=10%, SS= Open		0.1	0.5	2	msec
ON/OFF Startup Delay	Trcd	Vin High : ON/OFF Low → High/Open Vo=10%		0.1	0.4	2	msec

⚠ Note:

1. This datasheet is downloaded from the website of Murata Manufacturing co., Ltd. Therefore, it's specifications are subject to change or our products in it may be discontinued without advance notice. Please check with our sales representatives or product engineers before ordering.
2. This datasheet has only typical specifications because there is no space for detailed specifications. Therefore, please approve our product specifications or transact the approval sheet for product specifications before ordering.

6. 2 Thermal Derating

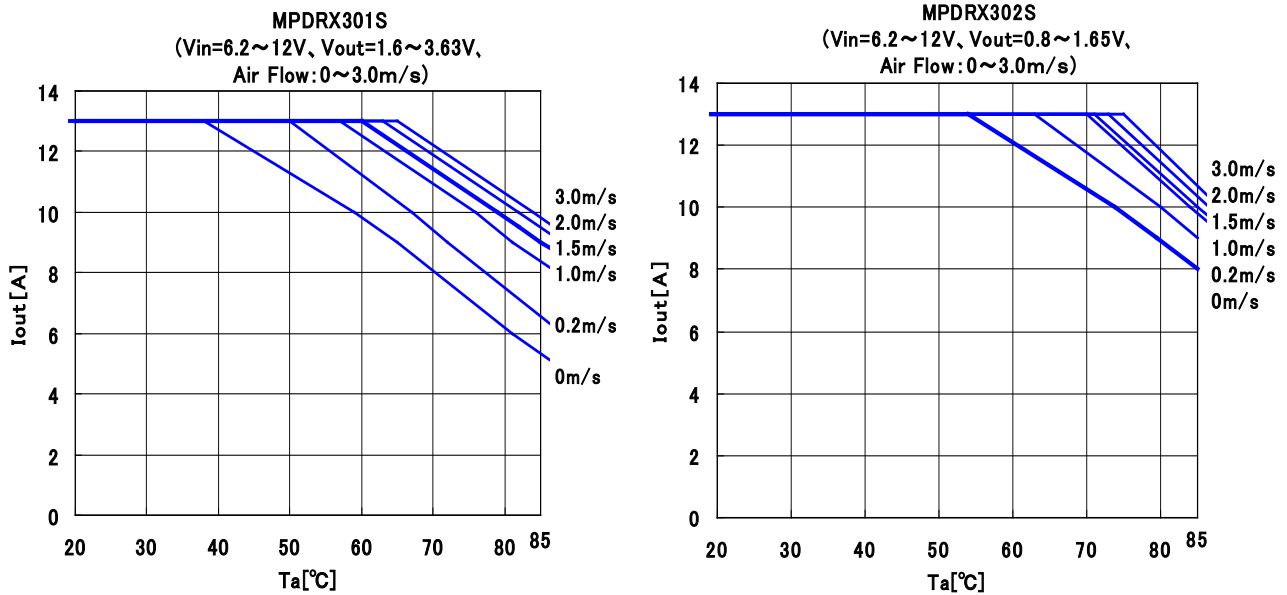

The above derating limits apply to this product soldered directly to 101.6*180mm*1.6mm PCB (6 layer). Any adjacent parts of high temperature may cause overheating. For reliable operation, please ensure that the FET temperature of this product is maintained below 120°C and the inductor temperature is below 111°C.

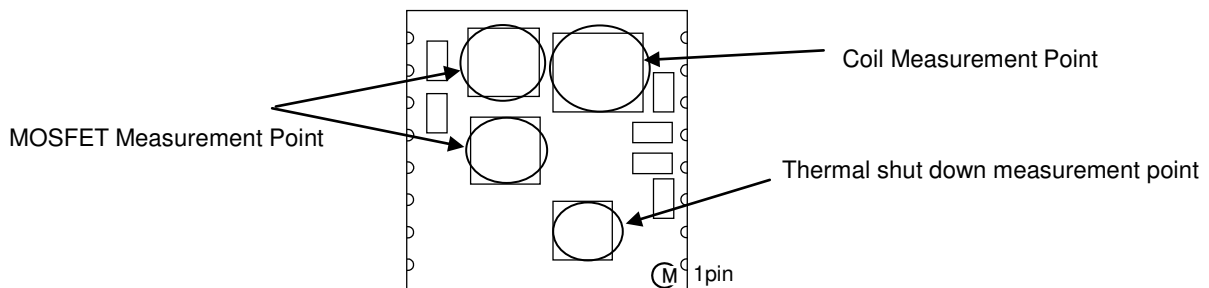

Note:

1. This datasheet is downloaded from the website of Murata Manufacturing co., Ltd. Therefore, it's specifications are subject to change or our products in it may be discontinued without advance notice. Please check with our sales representatives or product engineers before ordering.
2. This datasheet has only typical specifications because there is no space for detailed specifications. Therefore, please approve our product specifications or transact the approval sheet for product specifications before ordering.

7. Operation in information

7.1. Adjusting the Output Voltage

The output voltage can be adjusted by connecting resistors between VAR-pin(7Pin) to GND-pin.

The following equation gives the required external-resistor value to adjust the output voltage to V_{o-adj} .

It is highly recommended that evaluation of the characteristics of this DC-DC converter's operation under your board conditions be thoroughly conducted.

In case output voltage is used more than 0.95V, please connect FT-pin(8pin) to GND.

Internal Circuit

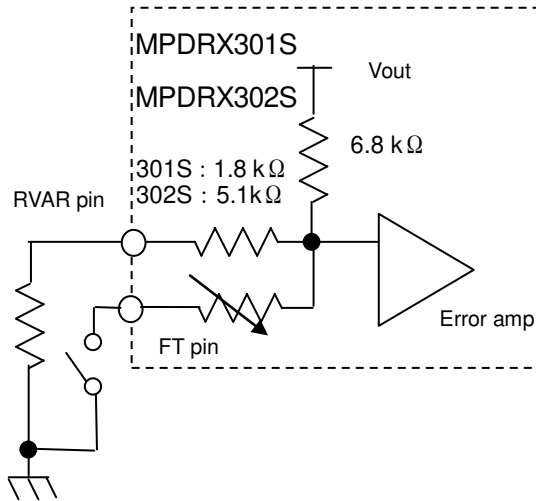

①MPDRX301S (FT-pin : SHORT to GND)

$$RVAR = \frac{5440}{V_{o-adj}[V] \times 1.002 - 1.5[V]} - 1800 \quad [\Omega]$$

②MPDRX302S

(a) $0.8 \leq V_{out} < 0.95V$ (FT-pin : OPEN)

$$RVAR = \frac{5440}{V_{o-adj}[V] \times 1.002 - 0.8[V]} - 5100 \quad [\Omega]$$

(b) $0.95 \leq V_{out} \leq 1.65V$ (FT-pin : SHORT to GND)

$$RVAR = \frac{5440}{V_{o-adj}[V] \times 1.002 - 0.95[V]} - 5100 \quad [\Omega]$$

<RVAR calculation example>

①MPDRX301S

Voadj [V]	Calculated RVAR[Ω]	FT pin(8pin)
3.63	745	Short to GND
3.3	1211	Short to GND
2.5	3613	Short to GND
1.8	16118	Short to GND
1.6	50913	Short to GND

②MPDRX302S

Voadj [V]	Calculated RVAR[Ω]	FT pin(8pin)
1.65	2635	Short to GND
1.5	4737	Short to GND
1.2	16453	Short to GND
1.0	99515	Short to GND
0.95	2858058	Short to GND
0.9	48338	Open
0.8	3394900	Open

7.2. Thermal shutdown

This DC-DC converter thermally shuts down when temperature of a control IC reaches to 180°C typically.

⚠ Note:

- This datasheet is downloaded from the website of Murata Manufacturing co., Ltd. Therefore, it's specifications are subject to change or our products in it may be discontinued without advance notice. Please check with our sales representatives or product engineers before ordering.
- This datasheet has only typical specifications because there is no space for detailed specifications. Therefore, please approve our product specifications or transact the approval sheet for product specifications before ordering.

7.3. Power Good

Powergood signal will be changed within the value of clause 6.1. (Open-drain output)

Output voltage is within voltage detection threshold: POW-GOOD is open.

Output Voltage is out of voltage detection threshold : POW-GOOD is connected to GND.

Hysteresis : 2.5% V_o (TYP)
Mask time : 50 μ s ~ (TYP)

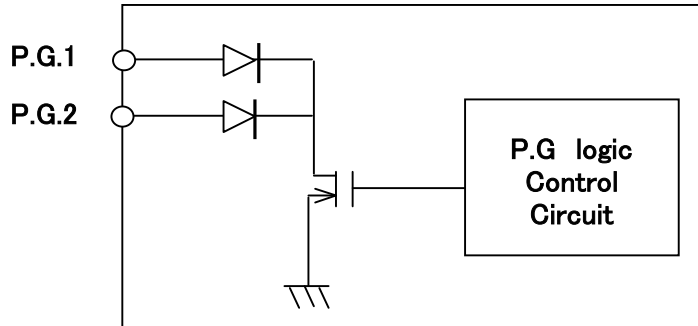

7.4. Output Voltage Sensing

By connecting the SENSE-pin to the load, the output voltage drop due to the PCB wiring may be compensated for.

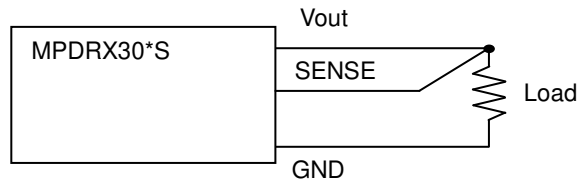

Please do NOT connect SENSE-pin to the output of LC filter that is set to the Vout line. When using this way, this product will not operate properly.

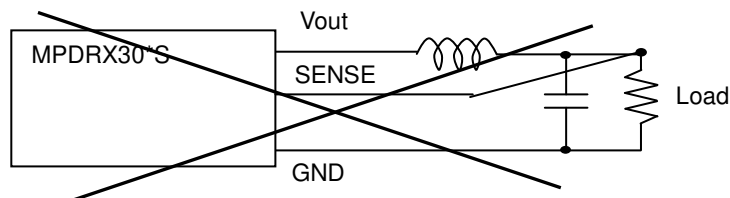

※Caution

Please connect SENSE-pin to Vout-pin nearby the product, if sense function is not used.

⚠ Note:

1. This datasheet is downloaded from the website of Murata Manufacturing co., Ltd. Therefore, it's specifications are subject to change or our products in it may be discontinued without advance notice. Please check with our sales representatives or product engineers before ordering.
2. This datasheet has only typical specifications because there is no space for detailed specifications. Therefore, please approve our product specifications or transact the approval sheet for product specifications before ordering.

7.5. Soft start function

By using the soft start function, ramp-rate of the output-starting is adjustable. Adjustment range of ramp-rate is from 2 to 10ms. Ramp rate is adjusted by external capacitor between SS-pin(6pin) and GND.

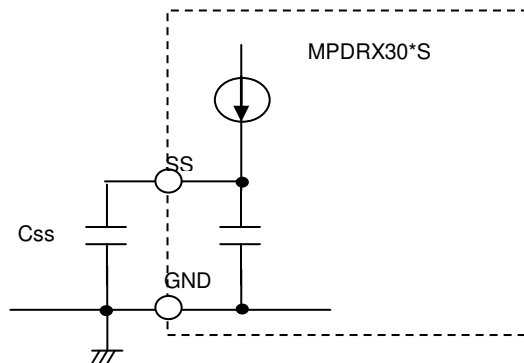

The equation of starting time about output voltage.

$$\text{Starting time : } T_d = \frac{(C_{SS} + 1.2 \times 10^{-8}) \times 0.8}{5 \times 10^{-6}} + 2 \times 10^{-4} [\text{s}]$$

C_{SS} : The capacitance of external capacitor.(F)

7.6. ON/OFF Control

ON/OFF function

Using the ON/OFF feature, the operation of this product can be disabled without removal of the input voltage.

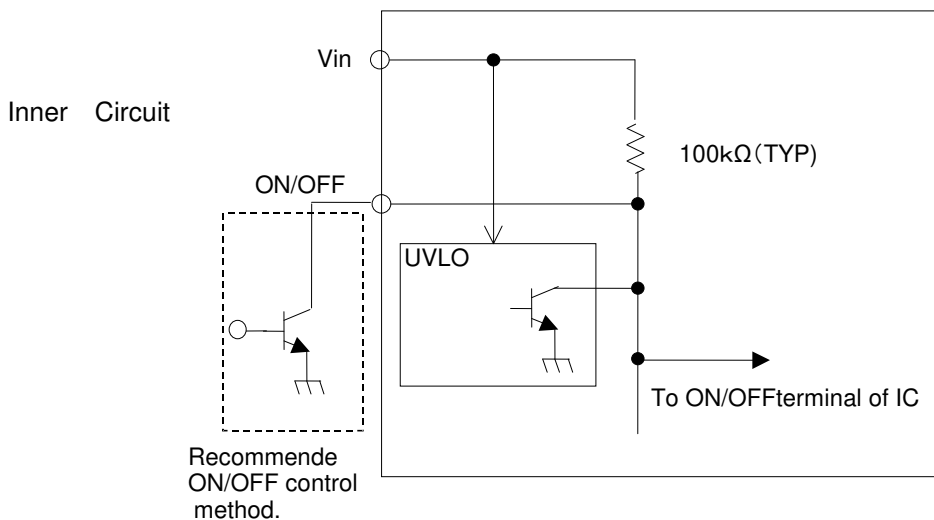

ON/OFF Control Operation

When ON/OFF-pin(13pin) is left open
 When ON/OFF-pin(13pin) is connected to GND

..... Output Voltage =ON
 Output Voltage=OFF

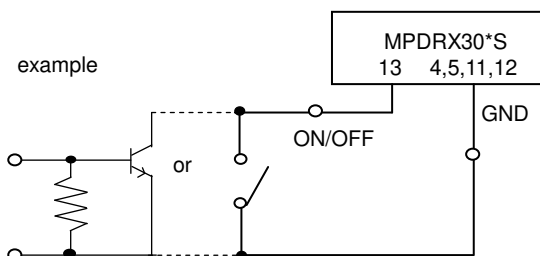

Caution

ON/OFF pin is pulled up inside of the DC-DC converter, so voltage appears up to 7V at ON/OFF pin.
 ON/OFF pin will be pulled down to GND inside the DC-DC converter when UVLO events occur.
 Please do NOT connect this pin to power supply, so as not to damage the converter.

ON/OFF pin of MPDRX301S/302S/303S/304S can be connected each other. The maximum number is up to 20pcs.

⚠ Note:

1. This datasheet is downloaded from the website of Murata Manufacturing co., ltd. Therefore, it's specifications are subject to change or our products in it may be discontinued without advance notice. Please check with our sales representatives or product engineers before ordering.
2. This datasheet has only typical specifications because there is no space for detailed specifications. Therefore, please approve our product specifications or transact the approval sheet for product specifications before ordering.

7.7. Reset Condition

In order to reset all function, the input Voltage is set under 0.5V for Min.100 m second or ON/OFF pin voltage is set under 1.0V for Min 10m second.

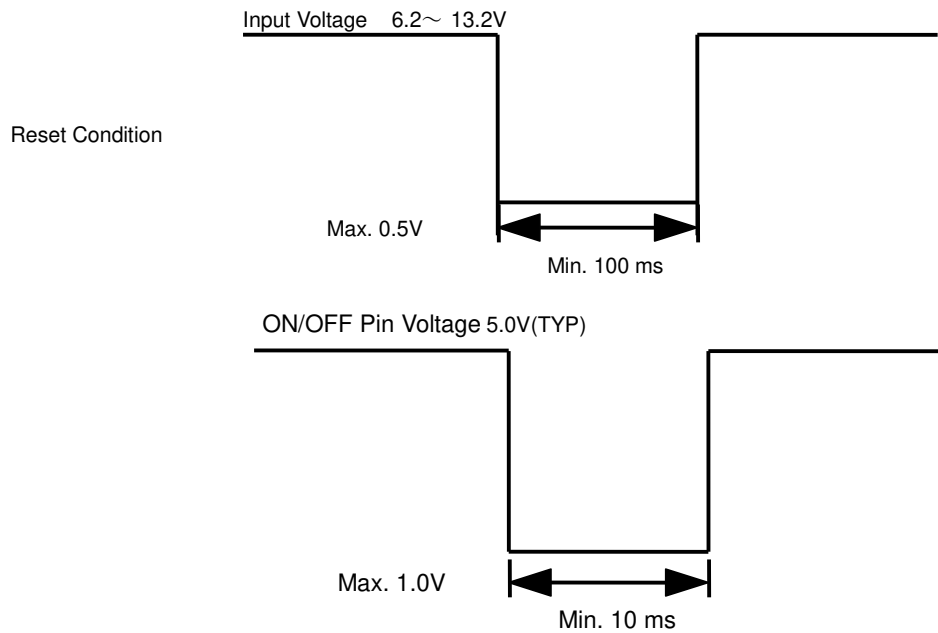

7.8. Input External capacitor

It is recommended to connect a low-impedance electrolytic capacitor of 20 μ F or more at Vin terminal. Smaller input capacitor may leads to an unstable operation of this product caused by input voltage fluctuation. Please check the proper operation of it on your product when smaller input capacitor is used.

Using ceramic capacitors as input capacitor may cause an increase of output voltage, because input ripple current flows through the external input capacitor and wiring resistance. This phenomenon is affected by the position of external capacitors, the value of external capacitors and voltage difference between Vin and Vout. Using low-impedance electrolytic capacitor will ease this problem. Please check the proper operation of it on your product when ceramic input capacitor is used.

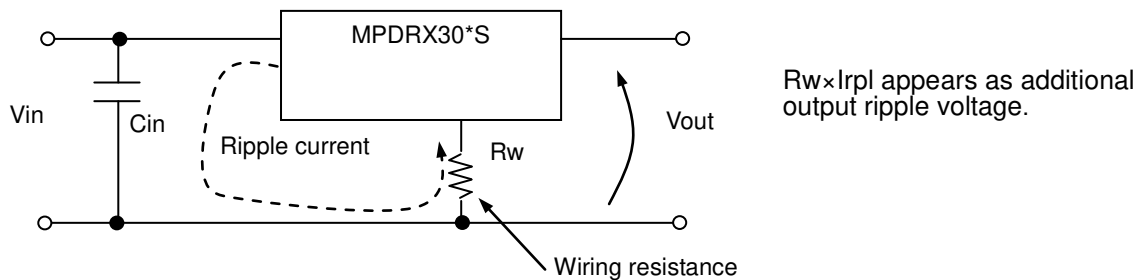

7.9. Output External capacitor

Ceramic capacitors are recommended as output external capacitor. Using ceramic capacitors, small output variation and small ripple voltage are realized.

Output capacitor should be within 100 μ F to 1000 μ F. Output capacitor shall be placed near the output terminal. When using plural capacitors, please make sure to place a capacitor of at least 100 μ F near the output terminal, and place other capacitors near the load.

When using LC output filter, please make sure to place a capacitor of at least 100 μ F near the output terminal.

⚠ Note:

1. This datasheet is downloaded from the website of Murata Manufacturing co., Ltd. Therefore, it's specifications are subject to change or our products in it may be discontinued without advance notice. Please check with our sales representatives or product engineers before ordering.
2. This datasheet has only typical specifications because there is no space for detailed specifications. Therefore, please approve our product specifications or transact the approval sheet for product specifications before ordering.

8. Reliability

8.1. Humidity Test

According to JIS-C-0022.

40±2°C, 90 to 95%RH, 100 hours.

Leave for 4 hours at room temperature.

No damage in appearance and no deviation from electrical characteristics (section 6.1).

8.2. Temperature Cycles Test

Repeat cycle 5 times. Leave 2 hours at room temp.

No damage in appearance and no deviation from electrical characteristics (section 6.1).

Step	Condition	Time
1	-40°C±3°C	30 minutes
2	Room Temp.	5~10 minutes
3	+85°C±2°C	30 minutes
4	Room Temp.	5~10 minutes

8.3. Vibration Test

10 to 55Hz, 1.5mm amplitude (frequency, 1minuit) 1 hour for each of X, Y, Z directions.

No damage in appearance and no deviation from electrical characteristics (section 6.1).

8.4. Mechanical Shock Test

20G, 1 time for each X, Y, Z directions.

No damage in appearance and no deviation from electrical characteristics (section 6.1).

 **Note:**

1. This datasheet is downloaded from the website of Murata Manufacturing co., ltd. Therefore, it' s specifications are subject to change or our products in it may be discontinued without advance notice. Please check with our sales representatives or product engineers before ordering.
2. This datasheet has only typical specifications because there is no space for detailed specifications. Therefore, please approve our product specifications or transact the approval sheet for product specifications before ordering.

9. Test Circuit

In the following test circuit, the initial values under item 6.1 should be met.

9.1. General Measure Circuit

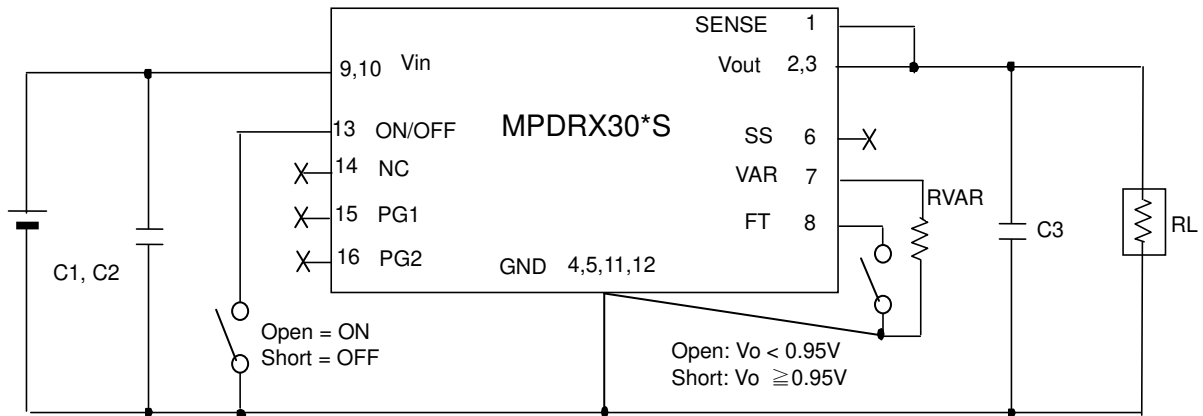

C1,C2 : 10 μ F/25V (Ceramic Capacitor)

C3 : 100 μ F/6.3V (Ceramic Capacitor)

※Please make sure to place C1,C2 and C3 nearby input and output terminal of DC-DC converter.

9.2. Ripple Voltage Measurement Circuit

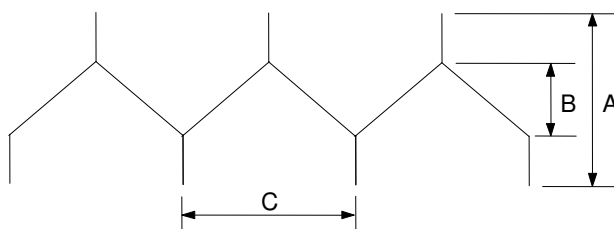
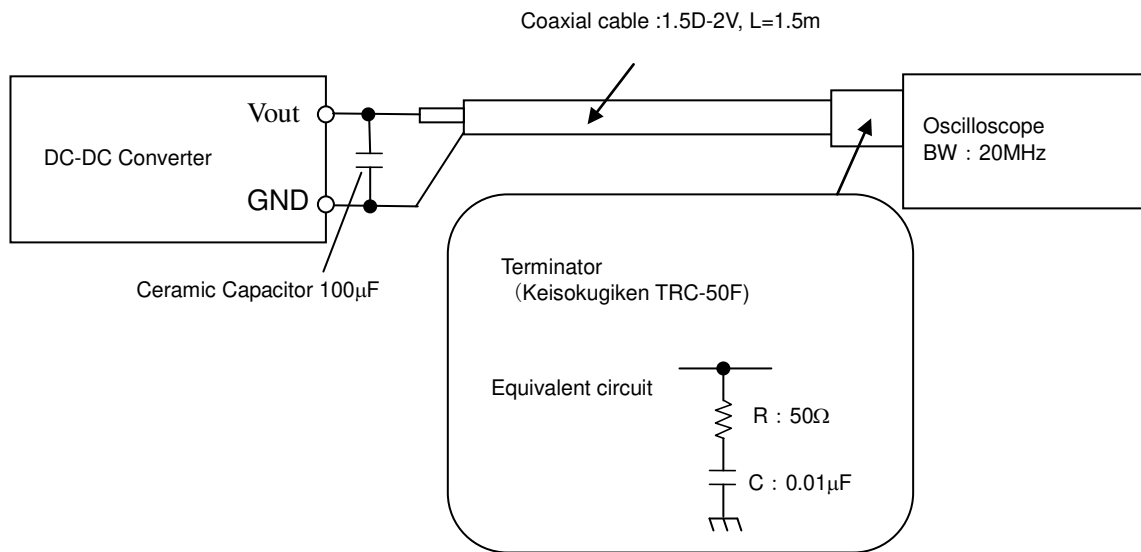

A: Output Ripple Voltage&Noise

B: Output Ripple Voltage

C: Switching Period

⚠ Note:

1. This datasheet is downloaded from the website of Murata Manufacturing co., ltd. Therefore, it's specifications are subject to change or our products in it may be discontinued without advance notice. Please check with our sales representatives or product engineers before ordering.
2. This datasheet has only typical specifications because there is no space for detailed specifications. Therefore, please approve our product specifications or transact the approval sheet for product specifications before ordering.

10. Mounting Condition

10. 1. PCB Land Pattern Recommendation

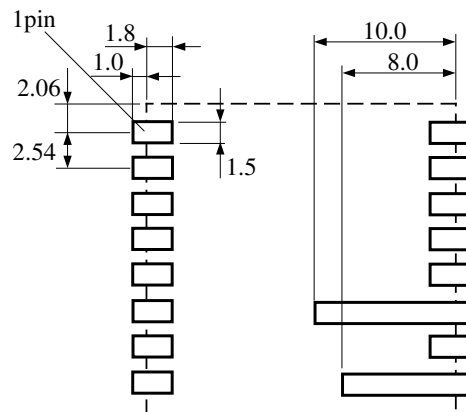

There are wiring coppers or through-hole via at the bottom side of the DC-DC converter. When you design your PCBs, please be careful not to short the circuit of the DC-DC converter or PCBs.

10. 2. Recommended Soldering Conditions

Reflow Soldering

This product is RoHS compliant. The following profile is recommended for the reflow of this product using Pb-free solder paste (Sn-Ag-Cu).

Method : Full convection reflow soldering

Reflow Soldering Profile

JEDEC IPC/JEDEC J-STD-020D
Table 5-2 Classification Reflow Profile
Pb-Free Assembly Large Body

Profile details

Soldering temperature	: 245°C+0/-5°C
Soldering time	: 30 seconds, 240 to 245°C
Heating time	: 60 to 150 seconds, over 217°C
Preheating time	: 60 to 120 seconds, 150 to 200°C
Programming rate	: 3°C/ sec. Max., 217 to 245°C
Descending rate	: 6°C/ sec. Max.
Total soldering time	: 8 minutes Max., 25 to 245°C
Times	: 1 time

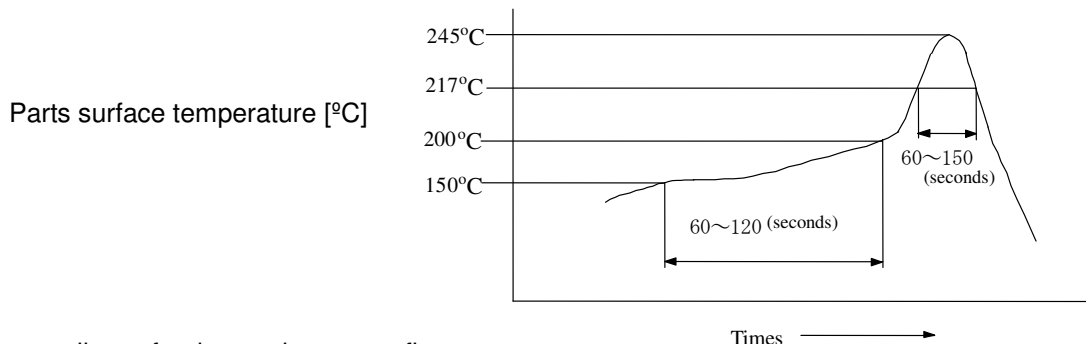

※Do not vibrate for the products on reflow.

Please need to take care temperature control because mounted parts may come off if the product are left under the high temperature.

Do not reflow DC-DC converter as follows, because DC-DC converter may fall down from a substrate during reflowing.

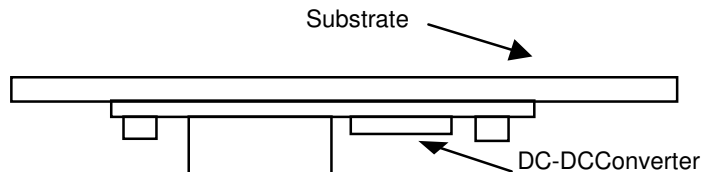

⚠ Note:

1. This datasheet is downloaded from the website of Murata Manufacturing co., ltd. Therefore, it's specifications are subject to change or our products in it may be discontinued without advance notice. Please check with our sales representatives or product engineers before ordering.
2. This datasheet has only typical specifications because there is no space for detailed specifications. Therefore, please approve our product specifications or transact the approval sheet for product specifications before ordering.

11. Packaging Specification

11.1. Tray Dimensions

DC-DC converters are put in the trays. (See Fig.1)

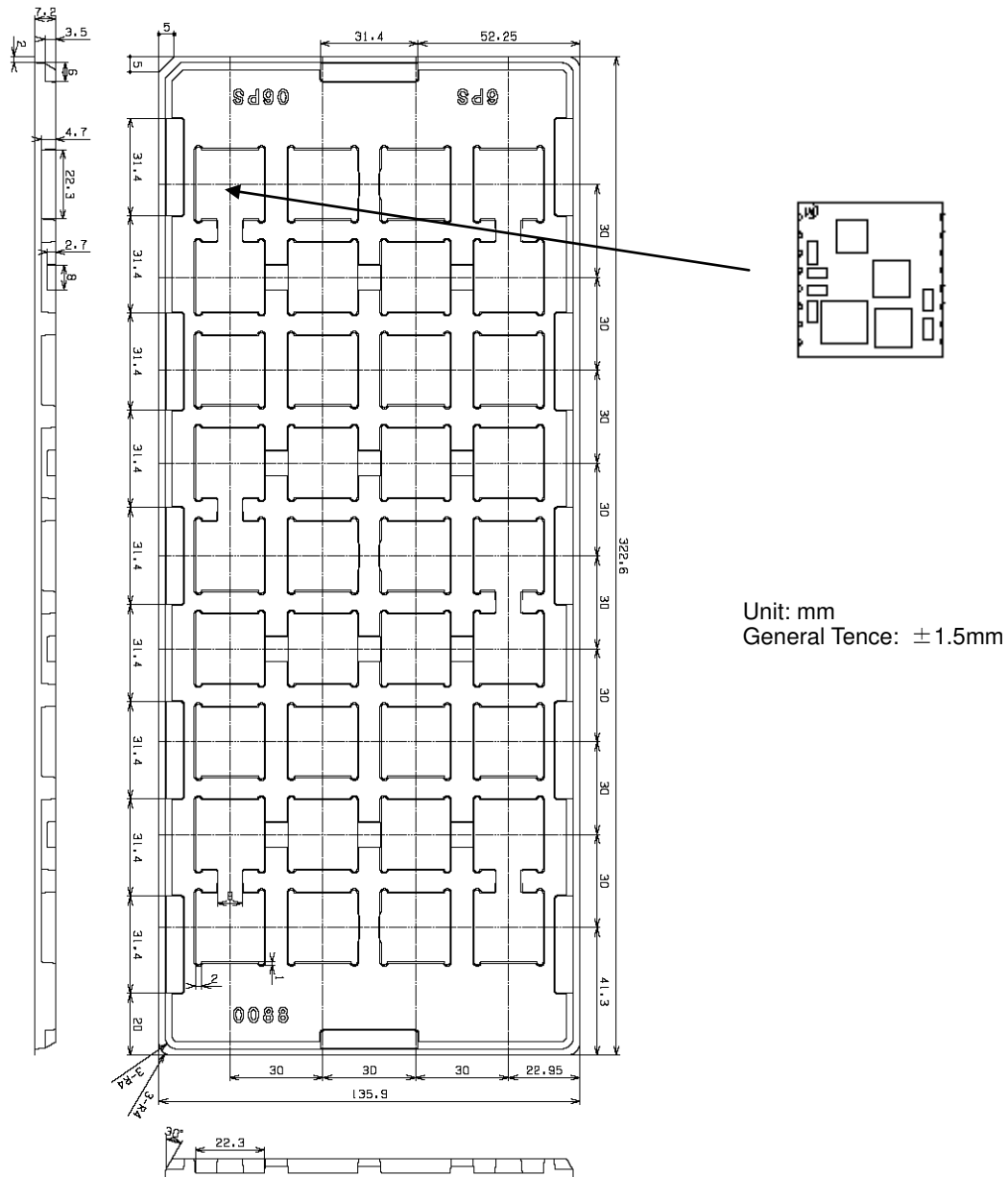

Fig.1

⚠ Note:

1. This datasheet is downloaded from the website of Murata Manufacturing co., ltd. Therefore, it's specifications are subject to change or our products in it may be discontinued without advance notice. Please check with our sales representatives or product engineers before ordering.
2. This datasheet has only typical specifications because there is no space for detailed specifications. Therefore, please approve our product specifications or transact the approval sheet for product specifications before ordering.

11. 2. Contained pieces of products per corrugated box.

Maximum Contained products pieces 324 pcs/corrugated box.

Further plural sheets of corrugated cardboard are placed on the top of the dummy tray according to number of contained trays in order to full up the space in a corrugated box.

11. 3. Packaging Form

Trays with products are lidded and packed in a corrugated box. (See Fig.2)

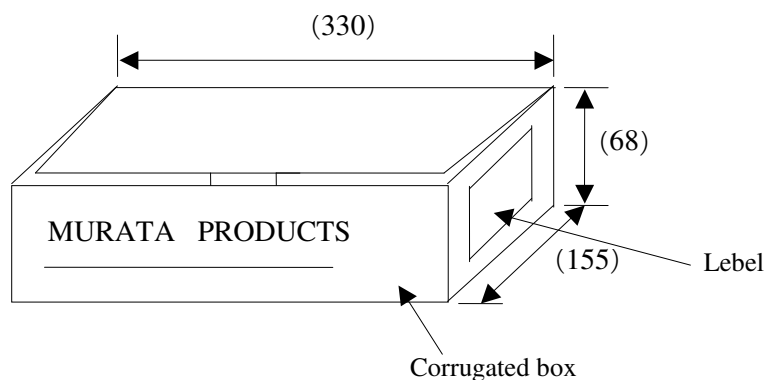
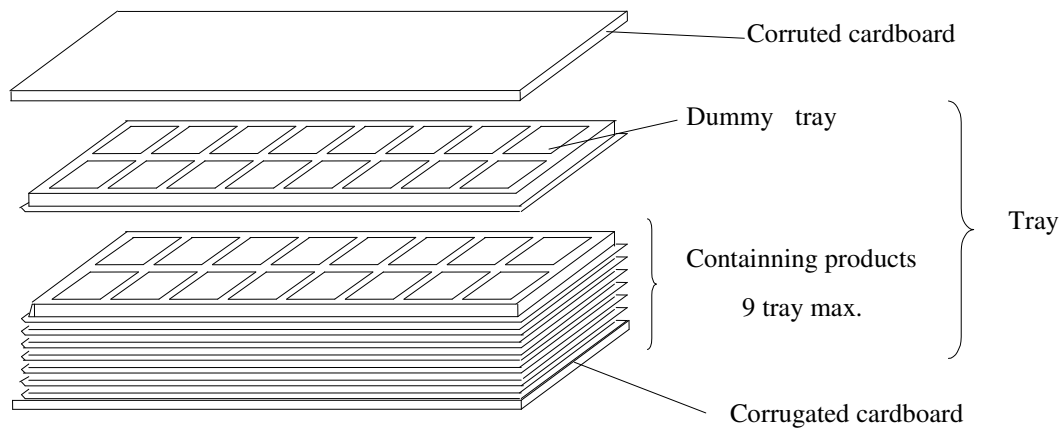

Dimension [unit : mm] of
Corrad box is reference only.

Fig.2

⚠ Note:

1. This datasheet is downloaded from the website of Murata Manufacturing co., ltd. Therefore, it's specifications are subject to change or our products in it may be discontinued without advance notice. Please check with our sales representatives or product engineers before ordering.
2. This datasheet has only typical specifications because there is no space for detailed specifications. Therefore, please approve our product specifications or transact the approval sheet for product specifications before ordering.

12. Typical Characteristics Data

12. 1. Load Transient Response

Our original ripple-detective control method achieves much better load transient responses.

$V_{in}=9.6V$, $V_o=2.5V$ (MPDRX301S, Fig. 11-1a) , $1.2V$ (MPDRX302S, Fig. 11-1b)

$I_o=0A \rightarrow 5A$, $di/dt=10A/\mu s$, $C_{out}=100\mu F$ (Ceramic), $T_a=25^\circ C$

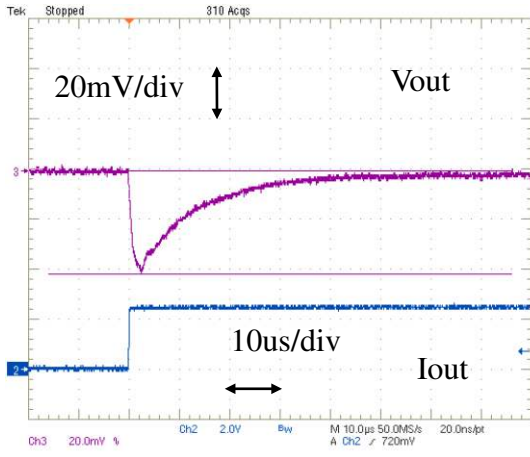

Fig. 12-1a. Load Transient Response (MPDRX301S)

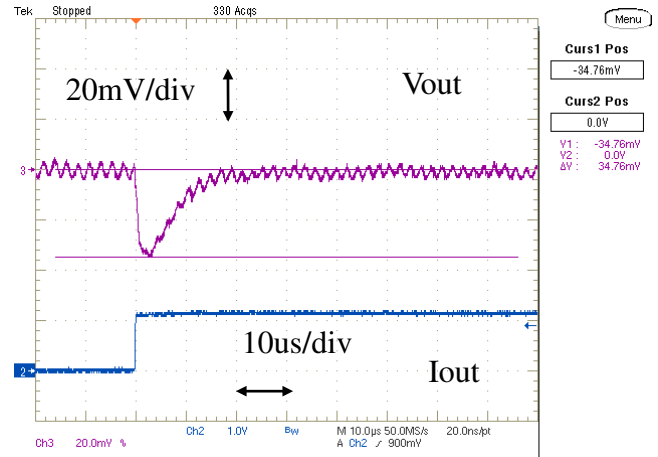

Fig. 12-1b. Load Transient Response (MPDRX302S)

12. 2. Output Impedance characteristics

Our original ripple-detective control method achieves very low output impedance in wide frequency range.

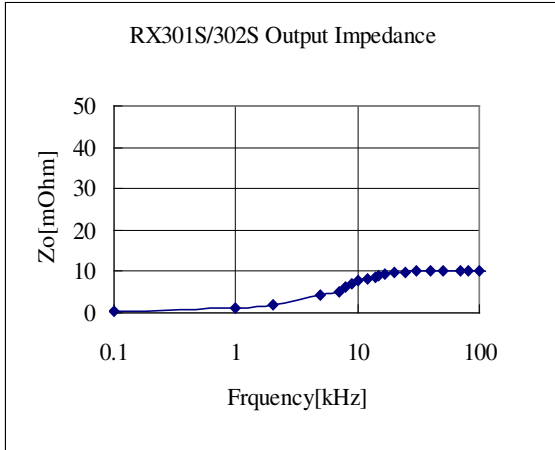

Fig. 12-2-1. Output Impedance of MPDRX301S/302S

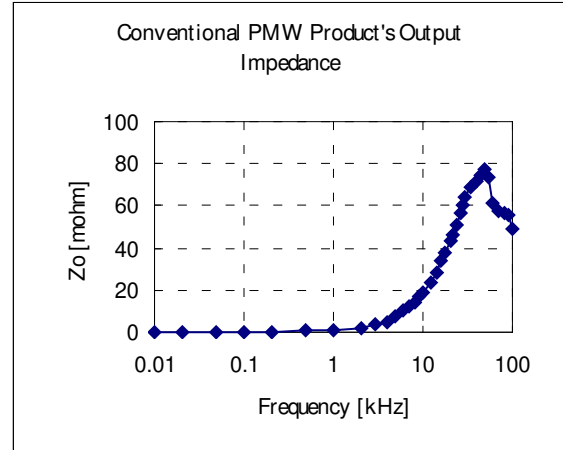

Fig. 12-2-2. Output Impedance of conventional product

Note:

1. This datasheet is downloaded from the website of Murata Manufacturing co., ltd. Therefore, it's specifications are subject to change or our products in it may be discontinued without advance notice. Please check with our sales representatives or product engineers before ordering.
2. This datasheet has only typical specifications because there is no space for detailed specifications. Therefore, please approve our product specifications or transact the approval sheet for product specifications before ordering.

12. 3. Other electrical characteristics

12. 3. 1. Vout=3.3V (MPDRX301S)

(Ta=25°C, Cin= GRM32DR71E106KA12L×2, Cout= GRM32EB30J107ME16, RVAR=1211Ω)

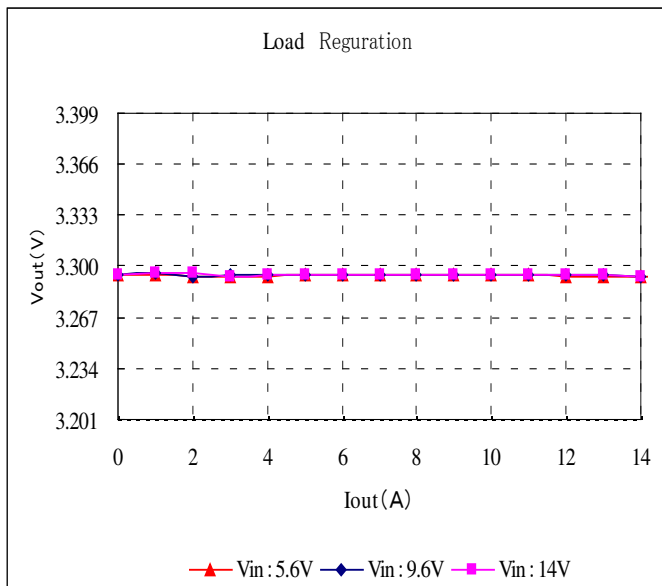

Fig. 12-3-1. Output Voltage v.s. Output Current

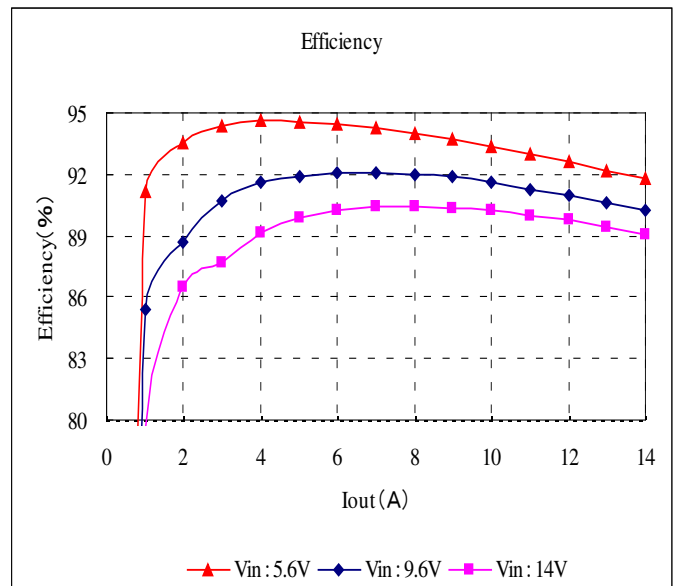

Fig. 12-3-2. Efficiency v.s. Output Current

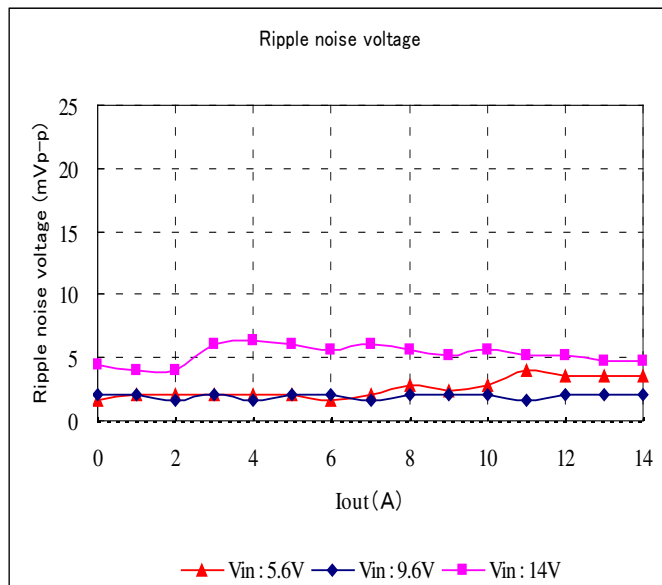

Fig. 12-3-3. Ripple Voltage v. s. Output Current

⚠ Note:

1. This datasheet is downloaded from the website of Murata Manufacturing co., ltd. Therefore, it's specifications are subject to change or our products in it may be discontinued without advance notice. Please check with our sales representatives or product engineers before ordering.
2. This datasheet has only typical specifications because there is no space for detailed specifications. Therefore, please approve our product specifications or transact the approval sheet for product specifications before ordering.

12. 3. 2. Vout=2.5V (MPDRX301S)

(Ta=25 °C, GRM32DR71E106KA12Lx2, Cout= GRM32EB30J107ME16L, RVAR=13613Ω)

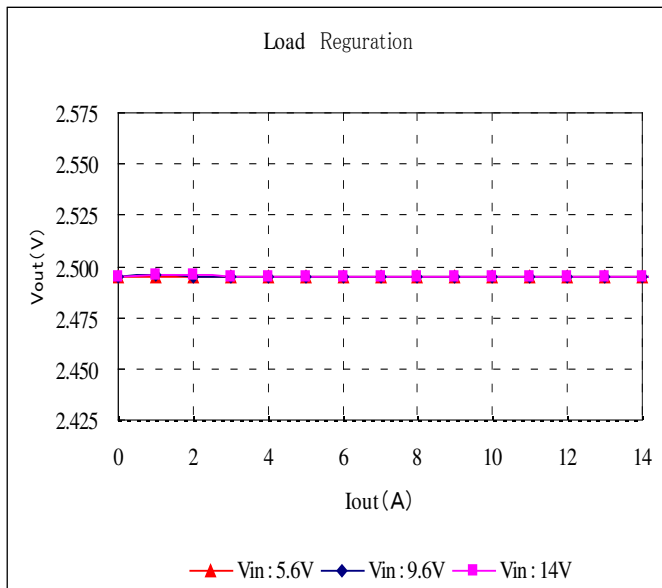

Fig. 12-3-4. Output Voltage v.s. Output Current

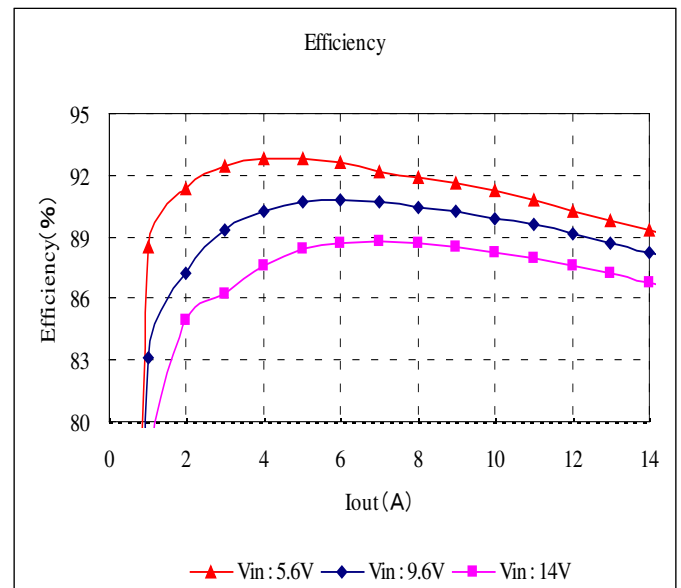

Fig. 12-3-5. Efficiency v.s. Output Current

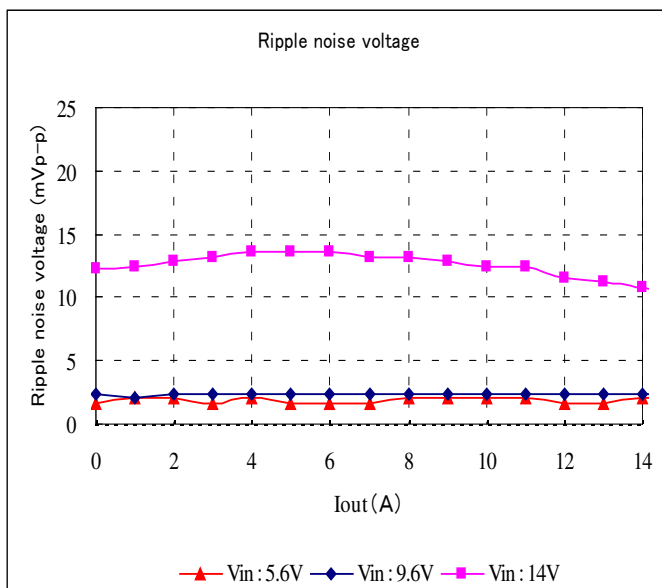

Fig. 12-3-6. Ripple Voltage v.s. Output Current

⚠ Note:

1. This datasheet is downloaded from the website of Murata Manufacturing co., ltd. Therefore, it's specifications are subject to change or our products in it may be discontinued without advance notice. Please check with our sales representatives or product engineers before ordering.
2. This datasheet has only typical specifications because there is no space for detailed specifications. Therefore, please approve our product specifications or transact the approval sheet for product specifications before ordering.

12. 3. 3. $V_{out}=1.8V$ (MPDRX301S)

(Ta=25 °C, GRM32DR71E106KA12Lx2, Cout= GRM32EB30J107ME16L, RVAR=16118Ω)

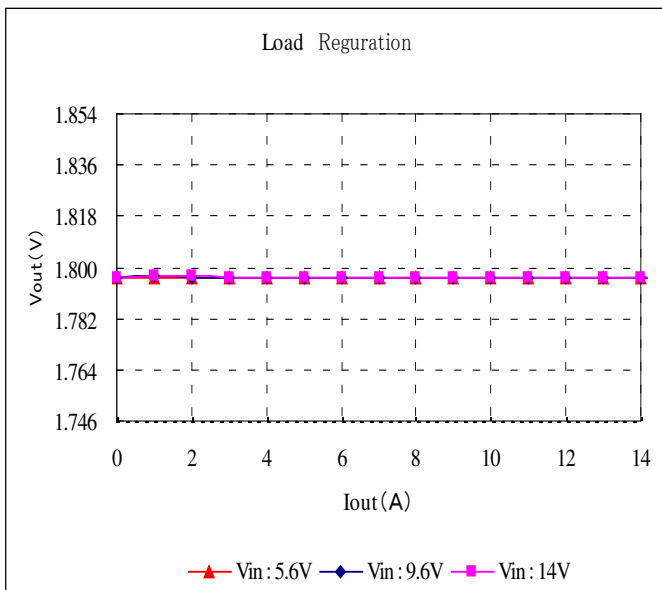

Fig. 12-3-7. Output Voltage v.s. Output Current

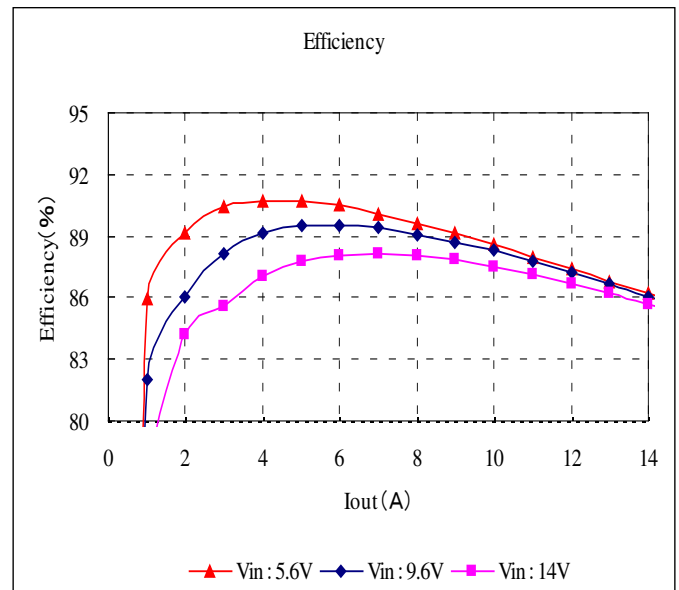

Fig. 12-3-8. Efficiency v.s. Output Current

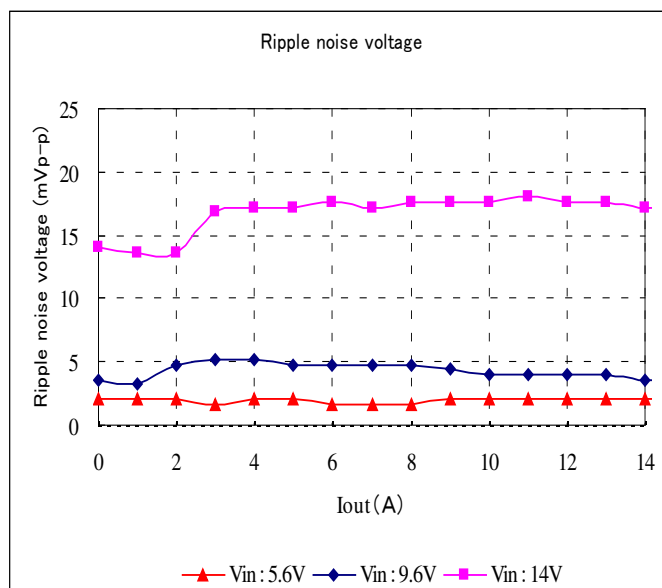

Fig. 12-3-9. Ripple Voltage v.s. Output Current

Note:

1. This datasheet is downloaded from the website of Murata Manufacturing co., ltd. Therefore, it's specifications are subject to change or our products in it may be discontinued without advance notice. Please check with our sales representatives or product engineers before ordering.
2. This datasheet has only typical specifications because there is no space for detailed specifications. Therefore, please approve our product specifications or transact the approval sheet for product specifications before ordering.

12. 3. 4. $V_{out}=1.5V$ (MPDRX302S)

(Ta=25 °C, GRM32DR71E106KA12Lx2, Cout= GRM32EB30J107ME16L, RVAR=4737Ω)

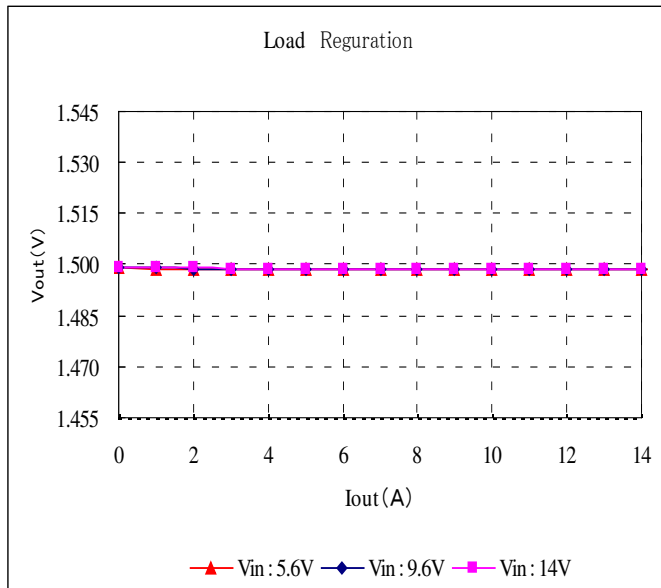

Fig. 12-3-10. Output Voltage v.s. Output Current

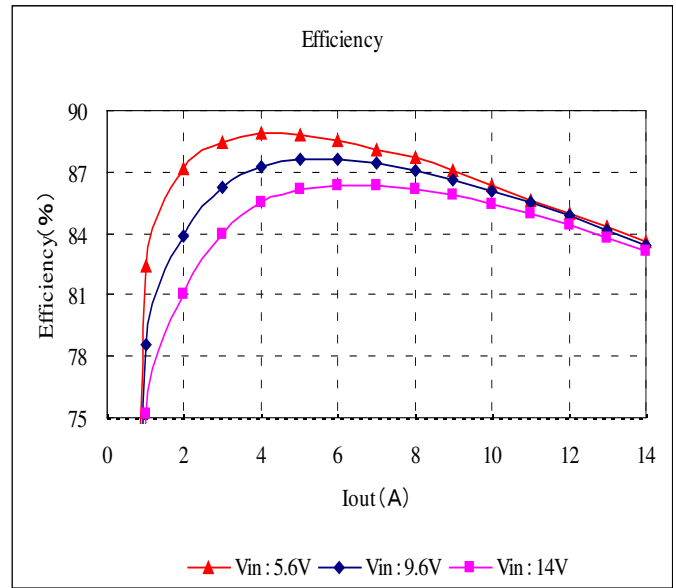

Fig. 12-3-11. Efficiency v.s. Output Current

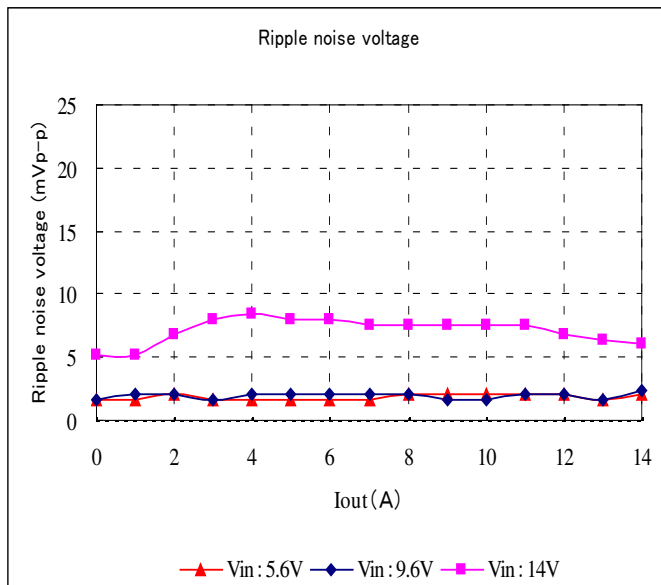

Fig. 12-3-12. Ripple Voltage v.s. Output Current

⚠ Note:

1. This datasheet is downloaded from the website of Murata Manufacturing co., ltd. Therefore, it's specifications are subject to change or our products in it may be discontinued without advance notice. Please check with our sales representatives or product engineers before ordering.
2. This datasheet has only typical specifications because there is no space for detailed specifications. Therefore, please approve our product specifications or transact the approval sheet for product specifications before ordering.

12. 3. 5. $V_{out}=1.2V$ (MPDRX302S)

(Ta=25 °C, GRM32DR71E106KA12Lx2, Cout= GRM32EB30J107ME16L, RVAR=16453Ω)

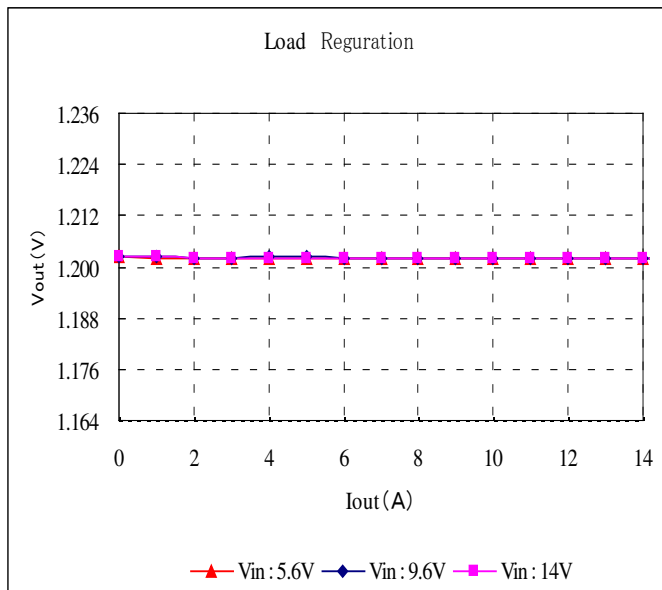

Fig. 12-3-13. Output Voltage v.s. Output Current

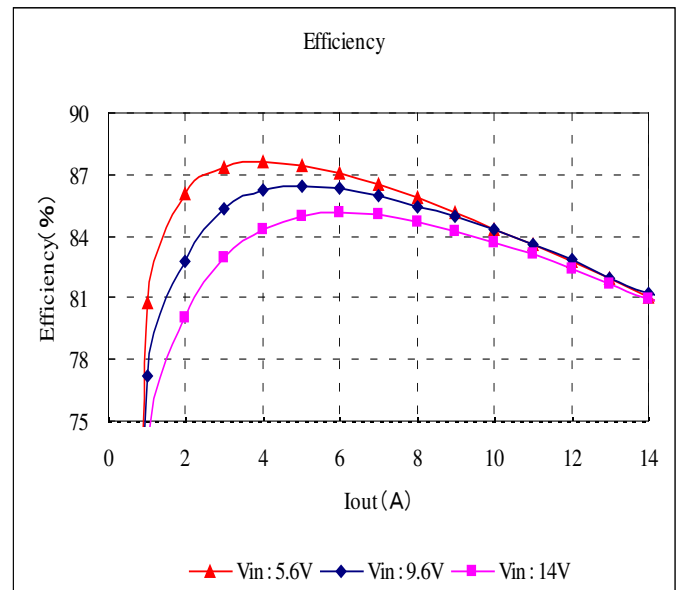

Fig. 12-3-14. Efficiency v.s. Output Current

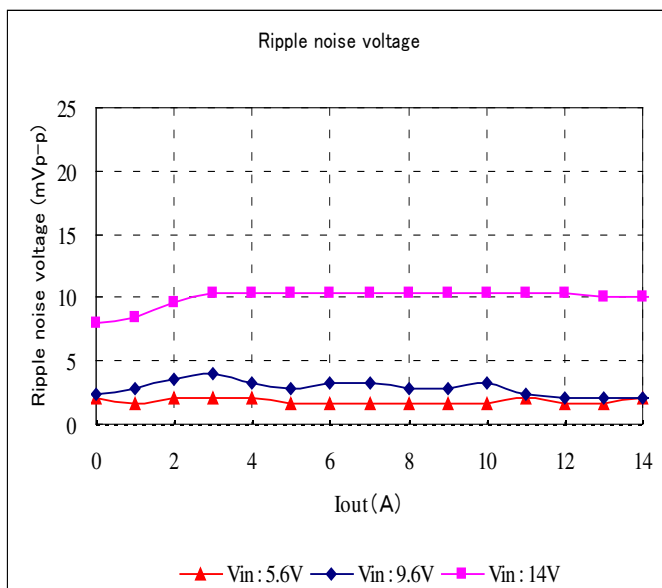

Fig. 12-3-15. Ripple Voltage v.s. Output Current

⚠ Note:

1. This datasheet is downloaded from the website of Murata Manufacturing co., ltd. Therefore, it's specifications are subject to change or our products in it may be discontinued without advance notice. Please check with our sales representatives or product engineers before ordering.
2. This datasheet has only typical specifications because there is no space for detailed specifications. Therefore, please approve our product specifications or transact the approval sheet for product specifications before ordering.

12. 3. 6. $V_{out}=0.8V$ (MPDRX302S)

(Ta=25 °C, GRM32DR71E106KA12Lx2, Cout= GRM32EB30J107ME16L, RVAR=3394900Ω)

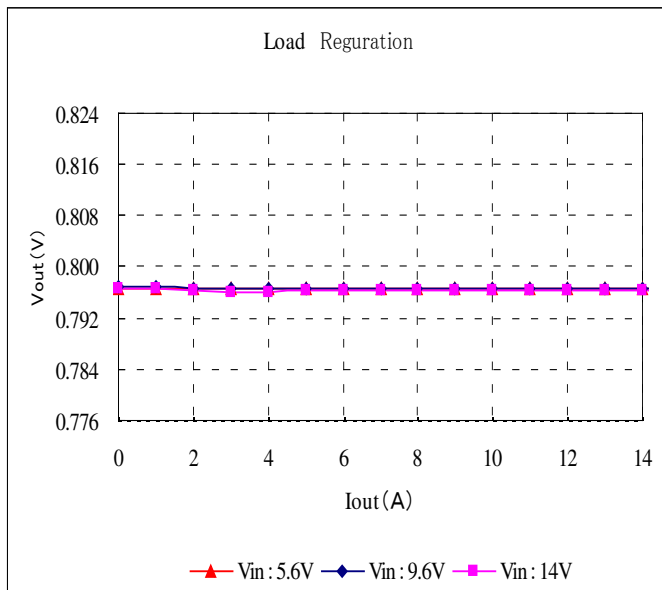

Fig. 12-3-16. Output Voltage v.s. Output Current

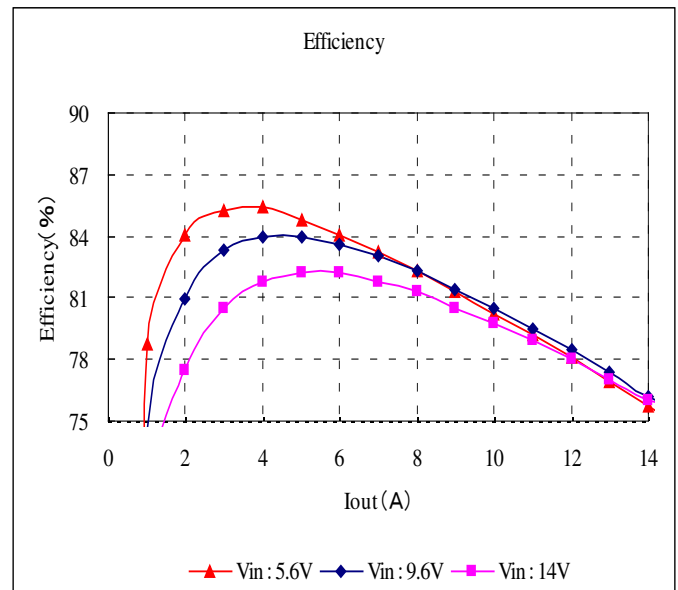

Fig. 12-3-17. Efficiency v.s. Output Current

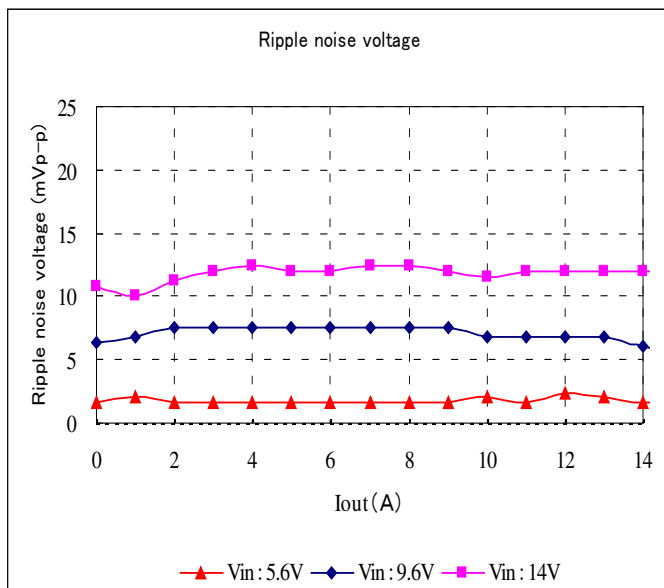

Fig. 12-3-18. Ripple Voltage v.s. Output Current

⚠ Note:

1. This datasheet is downloaded from the website of Murata Manufacturing co., ltd. Therefore, it's specifications are subject to change or our products in it may be discontinued without advance notice. Please check with our sales representatives or product engineers before ordering.
2. This datasheet has only typical specifications because there is no space for detailed specifications. Therefore, please approve our product specifications or transact the approval sheet for product specifications before ordering.

13. Notice

- 13.1. Please do not use a connector or a socket for connection with your board of this product. Electrical performance may be deteriorated the influence of contact resistance. Please be sure to mount this product with solder.
- 13.2. Be sure to provide an appropriate fail-safe function on your product to prevent a second damage that may be caused by the abnormal function or the failure of our product.
- 13.3. Input / Output capacitor
When a inductance or a switch devise are connected to the input line, or when you use a power supply with output inductance as the input voltage source, the input voltage of the DC-DC converter will be fluctuated. By this input voltage fluctuation, the transient load response of the DC-DC converter may be deteriorated or abnormal oscillation may occur. So please confirm normal operation on each application. Please use external input capacitor in order to decrease inductance of input line.
- 13.4. Wiring of input / output capacitor
In the case of input / output capacitor connection, in order to reduce electrical noise, please design PCBs with consideration of the following item.
- ①. Please be sure to check normal operation on your system.
 - ②. Please use low impedance capacitors with good high frequency characteristic.
 - ③. Please shorten those leads of each capacitor as much as possible, and make sure the lead Inductance low.
 - ④. Both input-side and output side, please make the wiring loop between plus and minus as small as possible. The influence of leakage inductance can be reduced.
 - ⑤. Please design the print pattern of the main circuit as wide and short as possible.

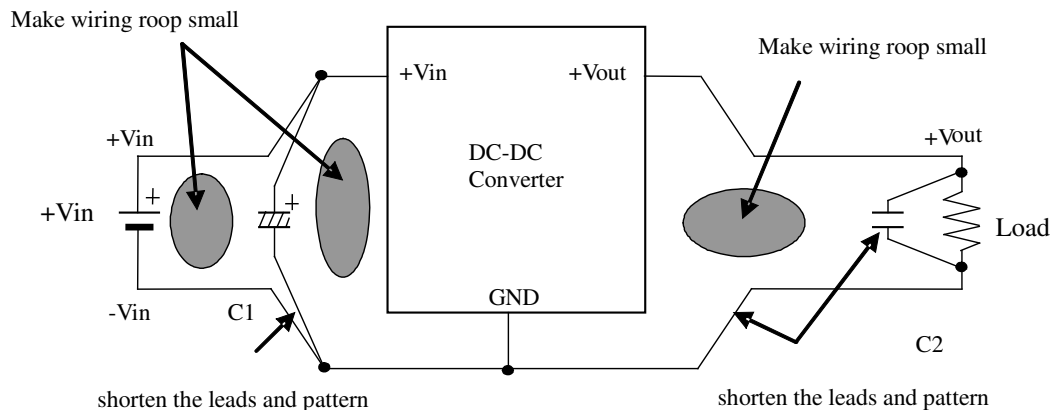

- 13.5. This product should not be operated in parallel or in series.
- 13.6. Inrush current protection is not a feature of this product. Please be careful that surge voltage caused by wiring inductance etc. may make the product damage when input voltage is applied suddenly to the product.
- 13.7. Please connect the input terminal with proper polarity. If you connect wrong polarity, the DC-DC Converter may be broken. In the case of the DC-DC Converter is damaged, abnormal input current may flow in, and abnormal overheat of the DC-DC Converter, or some damage of your products may occur. Please use a diode and a fuse to as following figure.

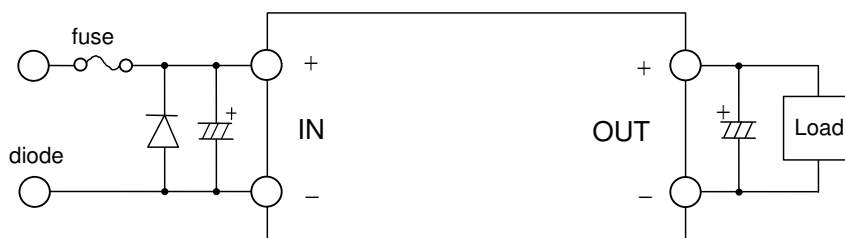

※Please select diode and fuse after confirming the operation.

⚠ Note:

1. This datasheet is downloaded from the website of Murata Manufacturing co., Ltd. Therefore, it's specifications are subject to change or our products in it may be discontinued without advance notice. Please check with our sales representatives or product engineers before ordering.
2. This datasheet has only typical specifications because there is no space for detailed specifications. Therefore, please approve our product specifications or transact the approval sheet for product specifications before ordering.

13.8. Cleaning

Please use no-cleaning type flux and do not wash this product.

13.9. Storage

13.9.1. Please store the products in room where the temperature/humidity is stable and direct sunlight cannot come in, and use the products within 6 months after delivery.

Please avoid damp and heat or such places where the temperature greatly changes, as water may condense on this product, and the quality of characteristics may be reduced, and/or the solderability may be degraded.

If this product needs to be stored for a long time (more than 1 year), this product may be degraded in solderability and/or corroded. Please test the solderability of this product regularly.

Baking before reflow process is unnecessary to store the products under 30°C, 60%RH or less up to 6 months.

In case the storage condition is over above mentioned, if these are unpacked condition, please bake them at 125°C±5°C/24hour. If these are packed in a tape, please bake them before soldering at 60°C±5°C/168hour.

13.9.2. Please do not store this product in places such as :

A dusty place, a place exposed directly to sea breeze, or in an atmosphere containing corrosive gas (Cl₂, NH₃, SO₂, NO_x and so on).

13.10. Operational Environment and Operational Conditions

13.10.1. Operational Environment

The products are not waterproof, chemical-proof or rust-proof.

In order to prevent leakage of electricity and abnormal temperature increase of the products, do not use the products under the following circumstances:

- (1) in an atmosphere containing corrosive gas (Cl₂, NH₃, SO₂, NO_x and so on).
- (2) in a dusty place.
- (3) in a place exposed to direct sunlight.
- (4) in such a place where water splashes or in such a humid place where water condenses.
- (5) in a place exposed to sea breeze.
- (6) in any other places similar to the above (1) through (5).

13.10.2. Operational Conditions

Please use the products within specified values (power supply, temperature, input, output and load condition, and so on). Input voltage drop for line impedance, so please make sure that input voltage is included in specified values.

If you use the products over the specified values, it may break the products, reduce the quality, and even if the products can endure the condition for short time, it may cause degradation of the reliability.

Also please take care that the external voltage over output voltage of DC-DC Converter does not apply to output of this DC-DC Converter.

13.10.3. Note prior to use

If you apply high static electricity, over rated voltage or reverse voltage to the products, it may cause defects in the products or degrade the reliability.

Please avoid the following items:

- (1) over rating power supply, reverse power supply or not-enough connection of 0 V(DC) line.
- (2) electrostatic discharge by production line and/or operator.
- (3) electrified product by electrostatic induction.

Do not give an excessive mechanical shock.

If you drop the products on the floor, etc., it may occur a crack to the core of inductors and monolithic ceramic capacitors.

Do not give a strong shock such as a drop in handling.

13.11. Transportation

If you transport the products, please pack them so that the package will not be damaged by mechanical vibration or mechanical shock, and please educate and guide a carrier to prevent rough handling.

If you transport the products to overseas (in particular, by sea), it is expected that the transportation environment will be the worst, so please pack the products, in the package designed on the consideration of mechanical strength, vibration-resistant and humidity-resistant. The package of the products which Murata sells in Japan, may not resist over seas transport.

Please consult us if you are to use the Murata package of the products sold in Japan for transport to overseas.

Note:

1. This datasheet is downloaded from the website of Murata Manufacturing co., Ltd. Therefore, it's specifications are subject to change or our products in it may be discontinued without advance notice. Please check with our sales representatives or product engineers before ordering.
2. This datasheet has only typical specifications because there is no space for detailed specifications. Therefore, please approve our product specifications or transact the approval sheet for product specifications before ordering.

**Note**

1. Murata recommends that customers ensure that the evaluation and testing of these devices are completed with this product actually assembled on their product.
2. Please contact our main sales office or nearby sales office before using our products for the applications listed below which require especially high reliability for the prevention of defects which might directly cause damage to the third party's life, body or property or this products for any other applications that described in the above.
 - ① Aircraft equipment
 - ② Aerospace equipment
 - ③ Undersea equipment
 - ④ Power plant control equipment
 - ⑤ Medical equipment
 - ⑥ Transportation equipment (vehicles, trains, ships, etc.)
 - ⑦ Traffic signal equipment
 - ⑧ Disaster prevention /crime prevention equipment
 - ⑨ Data-processing equipment
 - ⑩ Application of similar complexity and/or reliability requirements to the applications listed in the above.
3. If you have any concerned materials other than RoHS directive, please contact us.
4. About the written contents, since changing without a preliminary announcement for improvement and supply are sometimes stopped, please confirm in case of ordering. If written contents are unknown, please ask to our main sales office or nearby sales office.

**Note:**

1. This datasheet is downloaded from the website of Murata Manufacturing co., ltd. Therefore, it's specifications are subject to change or our products in it may be discontinued without advance notice. Please check with our sales representatives or product engineers before ordering.
2. This datasheet has only typical specifications because there is no space for detailed specifications. Therefore, please approve our product specifications or transact the approval sheet for product specifications before ordering.