



IR Emitter and Detector Product Data Sheet

LTE-3376

Spec No.: DS-50-95-0023

Effective Date: 12/17/2003

Revision: C

LITE-ON DCC

RELEASE

BNS-OD-FC001/A4

FEATURES

- * HIGH SPEED
- * HIGH POWER
- * AVAILABLE FOR PULSE OPERATING

PACKAGE DIMENSIONS

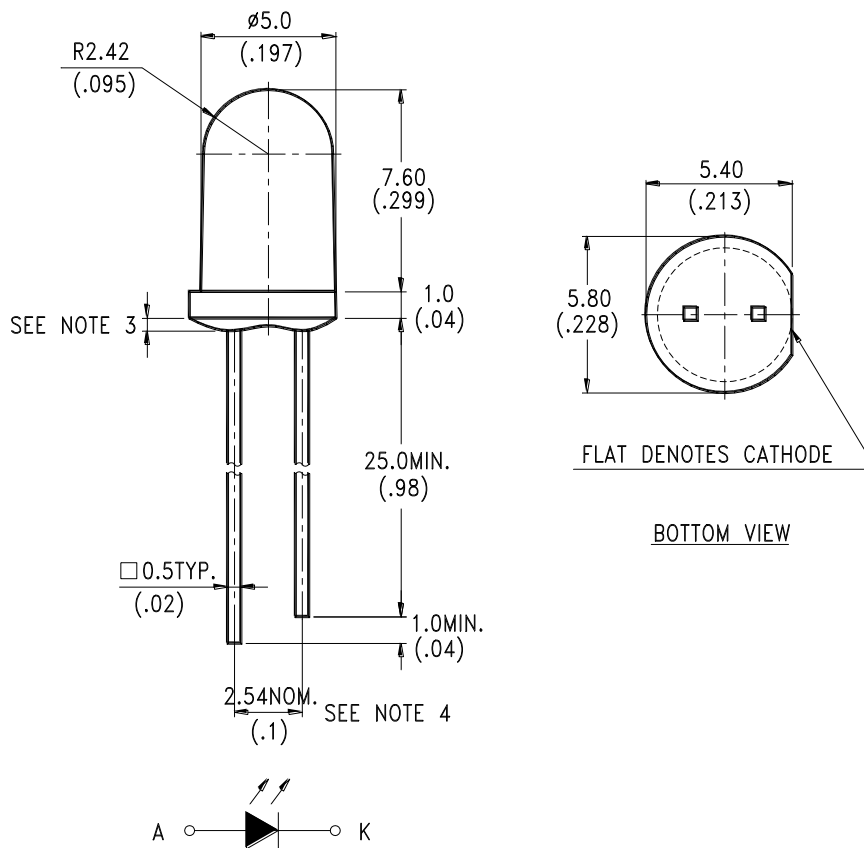

NOTES:

1. All dimensions are in millimeters (inches).
2. Tolerance is $\pm 0.25\text{mm}$ (.010") unless otherwise noted.
3. Protruded resin under flange is 1.5mm (.059") max.
4. Lead spacing is measured where the leads emerge from the package.
5. Specifications are subject to change without notice.



LITE-ON TECHNOLOGY CORPORATION.

Property of Lite-On Only

ABSOLUTE MAXIMUM RATINGS AT TA=25°C

PARAMETER	MAXIMUM RATING	UNIT
Power Dissipation	200	mW
Peak Forward Current (300pps, 10 μ s pulse)	1	A
Continuous Forward Current	80	mA
Reverse Voltage	5	V
Operating Temperature Range	-40°C to + 85°C	
Storage Temperature Range	-55°C to + 100°C	
Lead Soldering Temperature [1.6mm(.063") From Body]	260°C for 5 Seconds	

ELECTRICAL OPTICAL CHARACTERISTICS AT TA=25°C

PARAMETER	SYMBOL	MIN.	TYP.	MAX.	UNIT	TEST CONDITION
Radiant Intensity	I_E	30	45		mW/sr	$I_F = 50mA$
Peak Emission Wavelength	λ_{Peak}		850		nm	$I_F = 50mA$
Spectral Line Half-Width	$\Delta \lambda$		50		nm	$I_F = 50mA$
Forward Voltage	V_F		1.6	2.0	V	$I_F = 50mA$
Reverse Current	I_R			100	μA	$V_R = 5V$
Rise/Fall Time	T_r/T_f		30		nS	10%~90%
Viewing Angle (See FIG.6)	$2\theta_{1/2}$		30		deg.	

TYPICAL ELECTRICAL / OPTICAL CHARACTERISTICS CURVES

(25°C Ambient Temperature Unless Otherwise Noted)

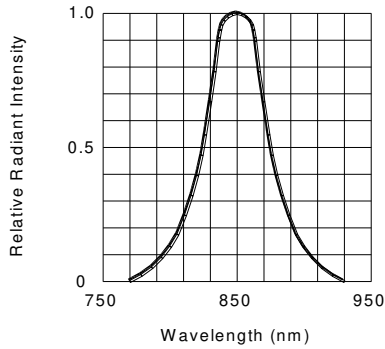

FIG.1 SPECTRAL DISTRIBUTION

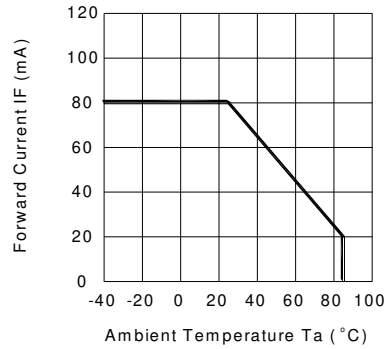

FIG.2 FORWARD CURRENT VS. AMBIENT TEMPERATURE

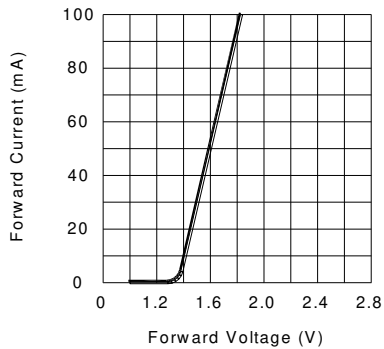

FIG.3 FORWARD CURRENT VS. FORWARD VOLTAGE

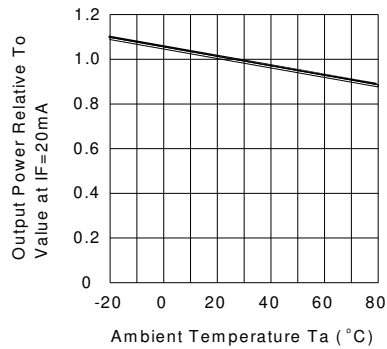

FIG.4 RELATIVE RADIANT INTENSITY VS. AMBIENT TEMPERATURE

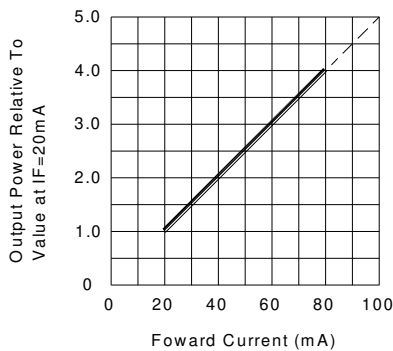

FIG.5 RELATIVE RADIANT INTENSITY VS. FORWARD CURRENT

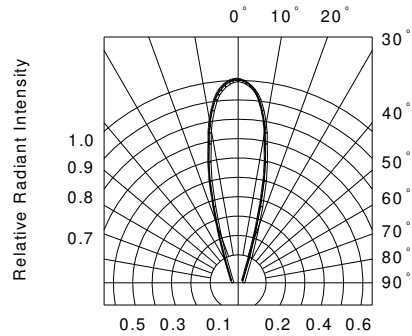

FIG.6 RADIATION DIAGRAM

PACKING

LITEON	
LITE-ON TECHNOLOGY CORP.	
CUSTOMER:	_____
DEVICE TYPE:	LTE-3376
BIN GRADE:	_____
LOT NO.:	_____
QTY:	_____
RMK:	_____

CUSTOMER	:	_____
CUSTOMER P/N	:	_____
DEVICE TYPE	:	LTE-3376
BIN	:	_____
COLOR RANK	:	_____
QUANTITY	:	_____
Q. C STAMP	:	_____

DIVICE NO.	BIN	QUANTITY
LTE-3376		
Q. C STAMP		

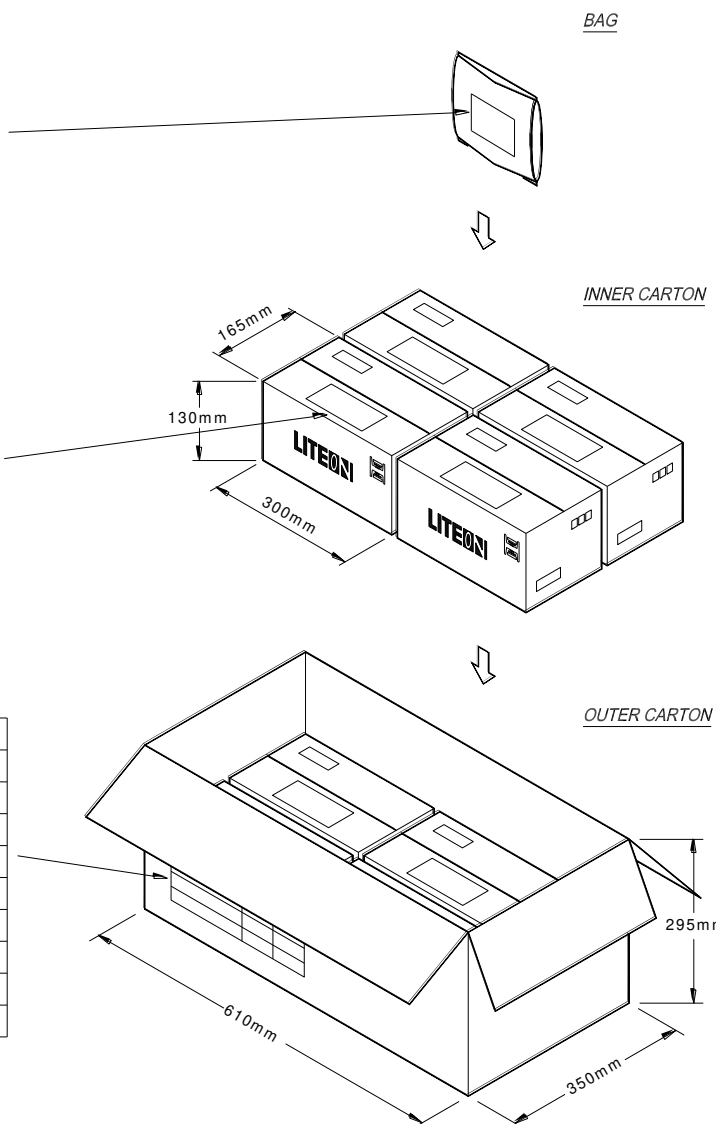

Bag volume (pcs / Bag)	Inner carton volume (Bag / carton)	Outer carton volume (Box / Carton)	Total volume (pcs/outer carton)
1000	8	8	64000