



# CPH5505

## Bipolar Transistor -30V, -3A, Low VCE(sat), PNP Dual CPH5

ON Semiconductor®

<http://onsemi.com>

### Applications

- Relay drivers, lamp drivers, motor drivers, flash

### Features

- Composite type with two PNP transistors contained in a single package facilitating high-density mounting
- The CPH5505 consists of two chips which are equivalent to the CPH3109 encapsulated in a package
- Ultrasmall package facilitates miniaturization in end products (mounting height : 0.9mm)

### Specifications

#### Absolute Maximum Ratings at Ta=25°C

Parameter	Symbol	Conditions	Ratings	Unit
Collector to Base Voltage	V <sub>CBO</sub>		-30	V
Collector to Emitter Voltage	V <sub>CEO</sub>		-30	V
Emitter to Base Voltage	V <sub>EBO</sub>		-5	V
Collector Current	I <sub>C</sub>		-3	A
Collector Current (Pulse)	I <sub>CP</sub>		-5	A
Base Current	I <sub>B</sub>		-600	mA
Collector Dissipation	P <sub>C</sub>	When mounted on ceramic substrate (600mm <sup>2</sup> ×0.8mm)	0.9	W
Total Dissipation	P <sub>T</sub>	When mounted on ceramic substrate (600mm <sup>2</sup> ×0.8mm)	1.2	W
Junction Temperature	T <sub>J</sub>		150	°C
Storage Temperature	T <sub>stg</sub>		-55 to +150	°C

Stresses exceeding Maximum Ratings may damage the device. Maximum Ratings are stress ratings only. Functional operation above the Recommended Operating Conditions is not implied. Extended exposure to stresses above the Recommended Operating Conditions may affect device reliability.

### Package Dimensions

unit : mm (typ)

7017A-009

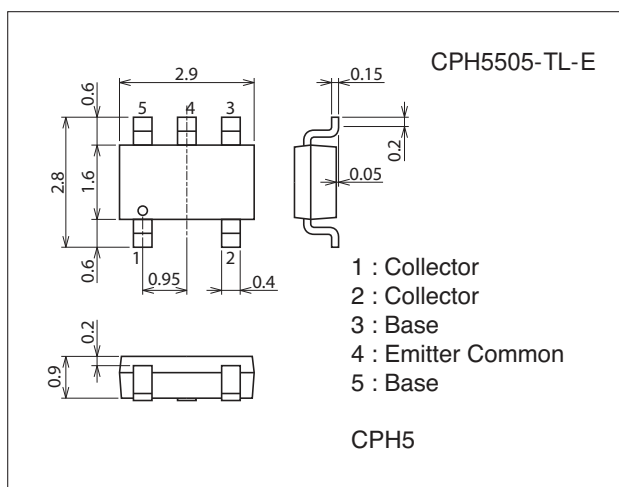

### Product & Package Information

- Package : CPH5
- JEITA, JEDEC : SC-74A, SOT-25
- Minimum Packing Quantity : 3,000 pcs./reel

### Packing Type : TL

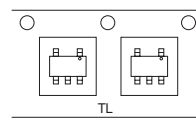

### Marking

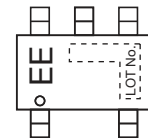

### Electrical Connection

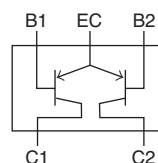

# CPH5505

## Electrical Characteristics at Ta=25°C

Parameter	Symbol	Conditions	Ratings			Unit
			min	typ	max	
Collector Cutoff Current	$I_{CBO}$	$V_{CB} = -30V, I_E = 0A$			-0.1	$\mu A$
Emitter Cutoff Current	$I_{EBO}$	$V_{EB} = -4V, I_C = 0A$			-0.1	$\mu A$
DC Current Gain	$h_{FE}$	$V_{CE} = -2V, I_C = -500mA$	200		560	
Gain-Bandwidth Product	$f_T$	$V_{CE} = -10V, I_C = -500mA$		380		MHz
Output Capacitance	Cob	$V_{CB} = -10V, f = 1MHz$		25		pF
Collector to Emitter Saturation Voltage	$V_{CE(sat)1}$	$I_C = -1.5A, I_B = -30mA$		-155	-230	mV
	$V_{CE(sat)2}$	$I_C = -1.5A, I_B = -75mA$		-105	-155	mV
Base to Emitter Saturation Voltage	$V_{BE(sat)}$	$I_C = -1.5A, I_B = -30mA$		-0.83	-1.2	V
Collector to Base Breakdown Voltage	$V_{(BR)CBO}$	$I_C = -10\mu A, I_E = 0A$	-30			V
Collector to Emitter Breakdown Voltage	$V_{(BR)CEO}$	$I_C = -1mA, R_{BE} = \infty$	-30			V
Emitter to Base Breakdown Voltage	$V_{(BR)EBO}$	$I_E = -10\mu A, I_C = 0A$	-5			V
Turn-ON Time	$t_{on}$	See specified Test Circuit.		50		ns
Storage Time	$t_{stg}$			270		ns
Turn-OFF Time	$t_f$			25		ns

## Switching Time Test Circuit

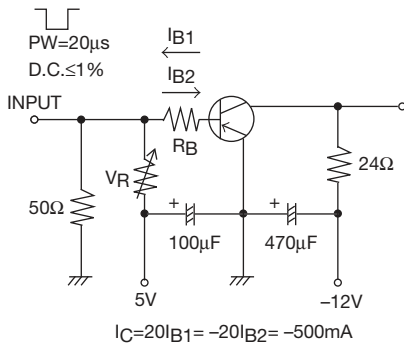

## Ordering Information

Device	Package	Shipping	memo
CPH5505-TL-E	CPH5	3,000pcs./reel	Pb Free

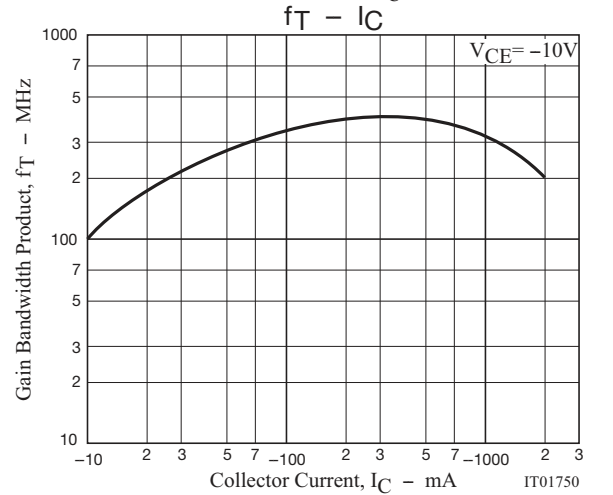
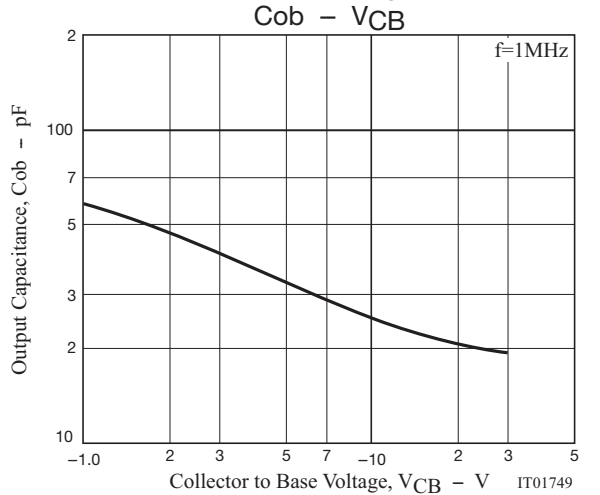
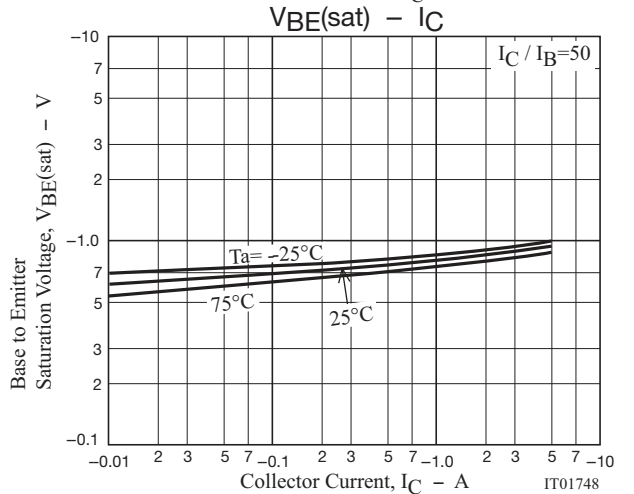
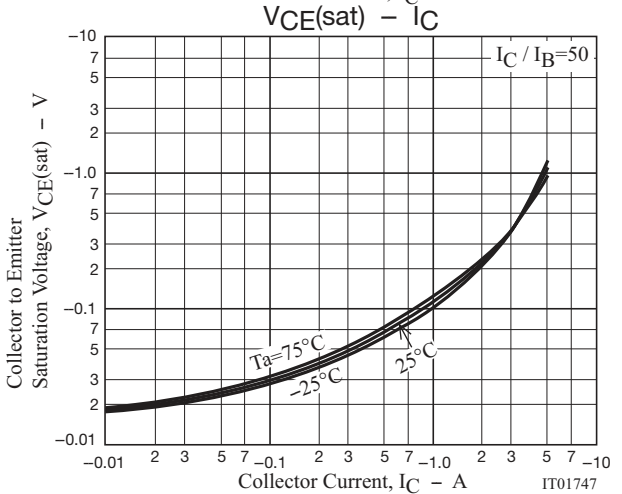
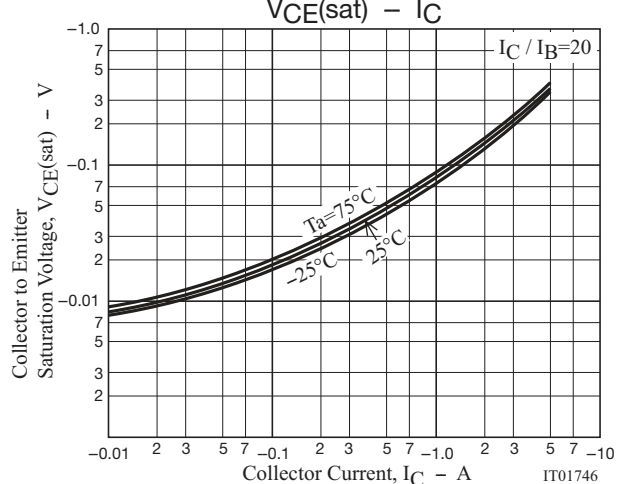
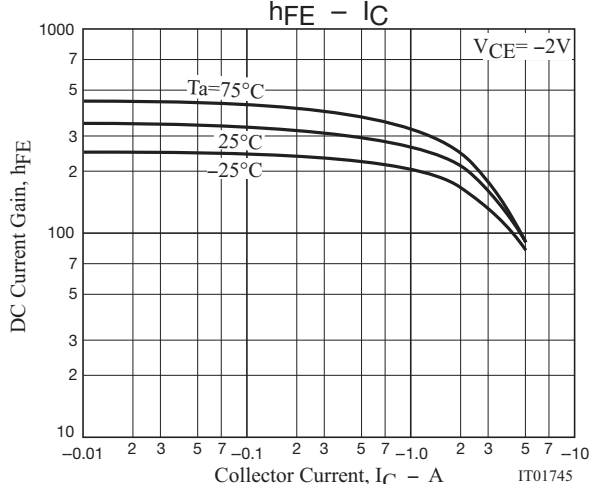
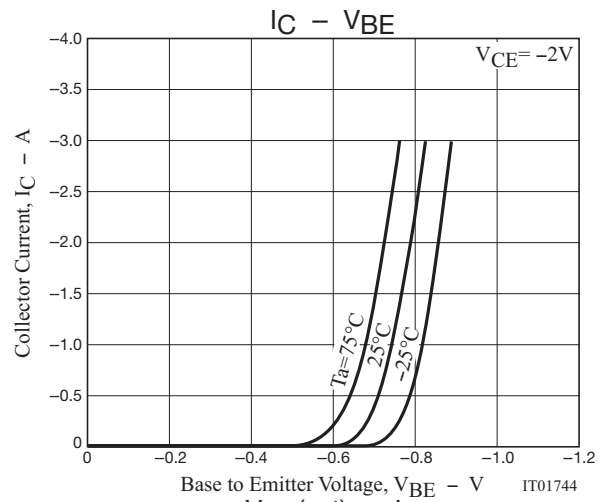
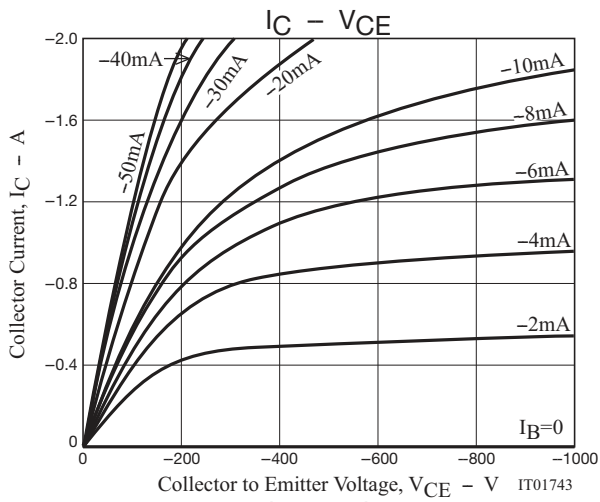

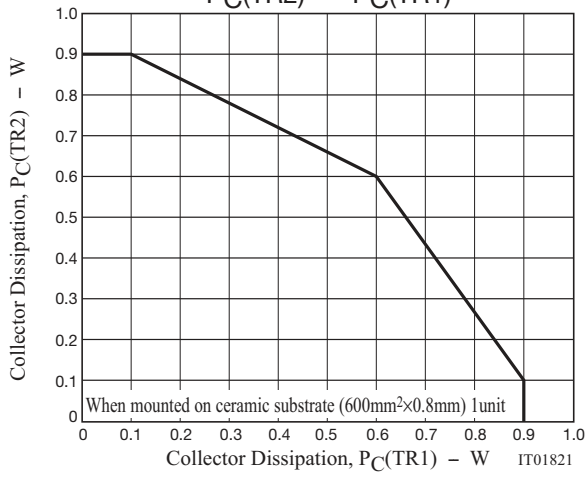
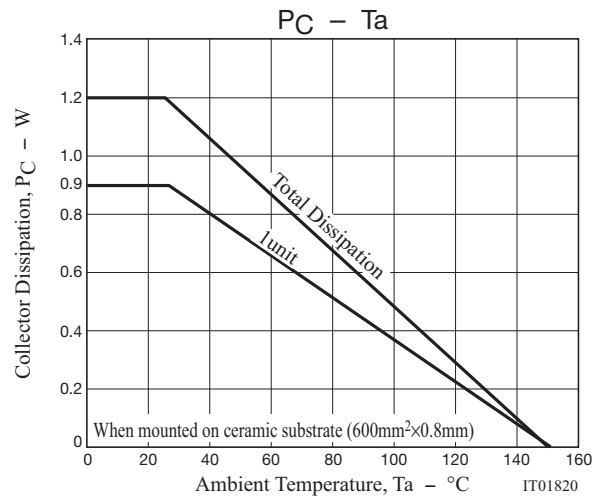
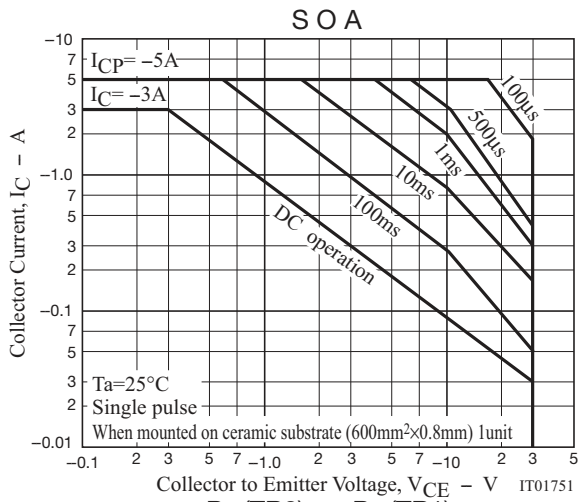

# CPH5505

## Outline Drawing

CPH5505-TL-E

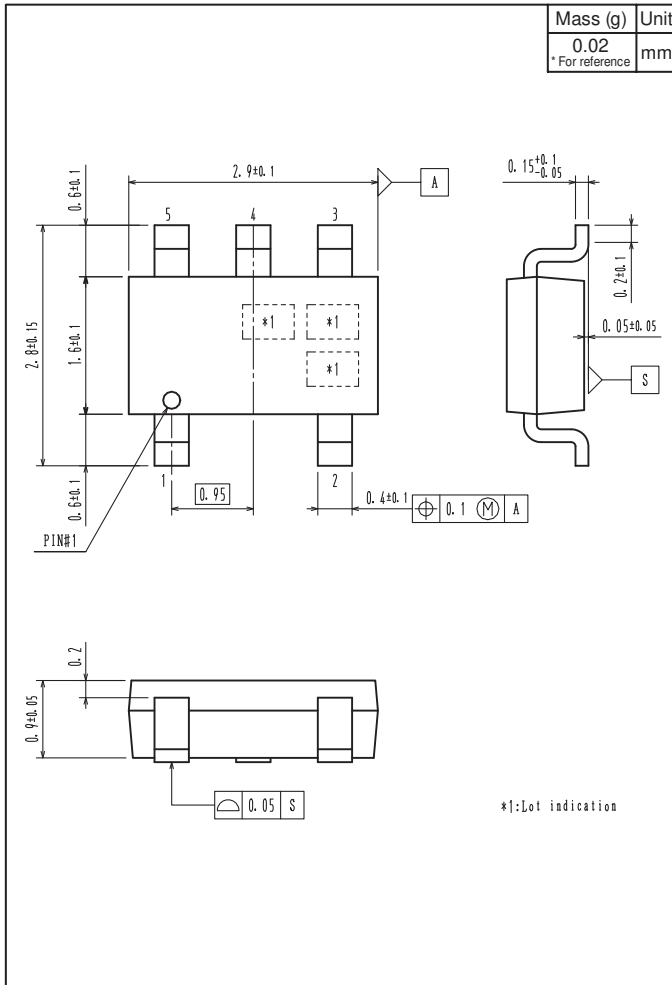

## Land Pattern Example

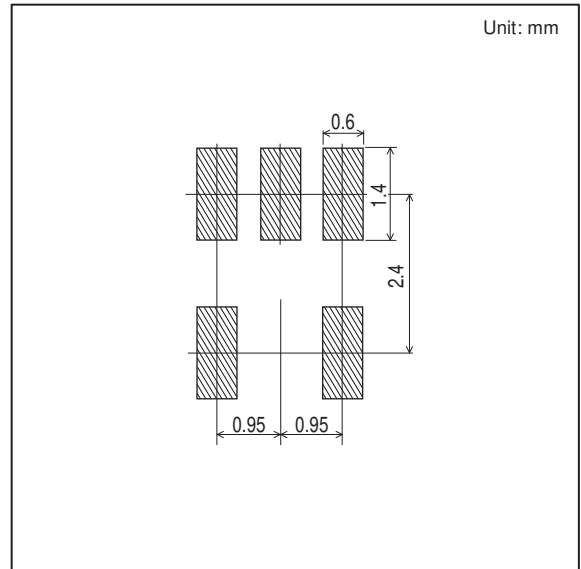

ON Semiconductor and the ON logo are registered trademarks of Semiconductor Components Industries, LLC (SCILLC). SCILLC owns the rights to a number of patents, trademarks, copyrights, trade secrets, and other intellectual property. A listing of SCILLC's product/patent coverage may be accessed at [www.onsemi.com/site/pdf/Patent-Marking.pdf](http://www.onsemi.com/site/pdf/Patent-Marking.pdf). SCILLC reserves the right to make changes without further notice to any products herein. SCILLC makes no warranty, representation or guarantee regarding the suitability of its products for any particular purpose, nor does SCILLC assume any liability arising out of the application or use of any product or circuit, and specifically disclaims any and all liability, including without limitation special, consequential or incidental damages. "Typical" parameters which may be provided in SCILLC data sheets and/or specifications can and do vary in different applications and actual performance may vary over time. All operating parameters, including "Typicals" must be validated for each customer application by customer's technical experts. SCILLC does not convey any license under its patent rights nor the rights of others. SCILLC products are not designed, intended, or authorized for use as components in systems intended for surgical implant into the body, or other applications intended to support or sustain life, or for any other application in which the failure of the SCILLC product could create a situation where personal injury or death may occur. Should Buyer purchase or use SCILLC products for any such unintended or unauthorized application, Buyer shall indemnify and hold SCILLC and its officers, employees, subsidiaries, affiliates, and distributors harmless against all claims, costs, damages, and expenses, and reasonable attorney fees arising out of, directly or indirectly, any claim of personal injury or death associated with such unintended or unauthorized use, even if such claim alleges that SCILLC was negligent regarding the design or manufacture of the part. SCILLC is an Equal Opportunity/Affirmative Action Employer. This literature is subject to all applicable copyright laws and is not for resale in any manner.