

LED..S50L.. High-Intensity Spot Light



Datasheet

For use with PresencePLUS and other vision systems

To view or download the latest technical information about this product, including specifications, dimensions, accessories, and wiring, go to www.bannerengineering.com.

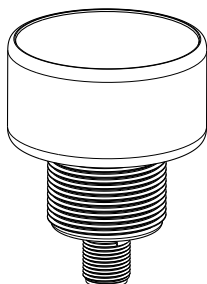

- Low-cost, washdown spot light for vision systems
- Continuous or strobed operation, depending on wiring
- Selectable Active High or Active Low strobe option, depending on wiring
- Optically isolated strobe signal
- Three lens options, depending on model, to vary spot size
- Illuminates a large area with an even pattern of light and no shadows
- 12 V DC to 30 V DC operation
- Cabled and quick-disconnect models available
- 50 mm diameter with flat profiles and 30 mm mounting base
- Rugged sealed housing rated to IP69K per DIN 40050-9



Important: Read the following instructions before operating the light. Please download the complete LED..S50L.. High-Intensity Spot Light technical documentation, available in multiple languages, from www.bannerengineering.com for details on the proper use, applications, Warnings, and installation instructions of this device.



Important: Lea el siguiente instructivo antes de operar el luminario. Por favor descargue desde www.bannerengineering.com toda la documentación técnica de los LED..S50L.. High-Intensity Spot Light, disponibles en múltiples idiomas, para detalles del uso adecuado, aplicaciones, advertencias, y las instrucciones de instalación de estos dispositivos.



Important: Lisez les instructions suivantes avant d'utiliser le luminaire. Veuillez télécharger la documentation technique complète des LED..S50L.. High-Intensity Spot Light sur notre site www.bannerengineering.com pour les détails sur leur utilisation correcte, les applications, les notes de sécurité et les instructions de montage.

Models

Model ¹	LED Color	Lumens / mWatts	Lux / mW/cm ²		Lens Angle	Connection
			0.5 m	1 m		
LEDWS50L5-XQ	White, 5000-8300 K	295 lm	13780 lx	3445 lx	±5° (smaller, more focused spot; see graph)	5 pin M12 integral QD connector (use with 5-wire mating cordset)
LEDRS50L5-XQ	Red, 620-630 nm	110 lm	8000 lx	2000 lx		
LEDBS50L5-XQ	Blue, 465-485 nm	85 lm	4880 lx	1220 lx		
LEDGS50L5-XQ	Green, 520-535 nm	210 lm	13000 lx	3250 lx		
LEDIS50L5-XQ	Infrared, 850 nm	760 mW	4.40 mW/cm ²	1.10 mW/cm ²		
LEDUV395S50L5-XQ	Ultraviolet, 395 nm	480 mW	2.10 mW/cm ²	.525 mW/cm ²		
LEDWS50L11-XQ	White, 5000-8300 K	285 lm	5460 lx	1365 lx	±11° (larger spot; see graph)	
LEDRS50L11-XQ	Red, 620-630 nm	105 lm	2500 lx	625 lx		
LEDBS50L11-XQ	Blue, 465-485 nm	80 lm	1540 lx	385 lx		
LEDGS50L11-XQ	Green, 520-535 nm	200 lm	3900 lx	975 lx		
LEDUV395S50L11-XQ	Ultraviolet, 395 nm	420 mW	.780 mW/cm ²	.195 mW/cm ²		
LEDIS50L14-XQ	Infrared, 850 nm	665 mW	1.16 mW/cm ²	.290 mW/cm ²	±14° (larger spot; see graph)	
LEDWS50L20-XQ	White, 5000-8300 K	270 lm	2000 lx	500 lx	±20° (largest spot; see graph)	
LEDRS50L20-XQ	Red, 620-630 nm	100 lm	1040 lx	260 lx		
LEDBS50L20-XQ	Blue, 465-485 nm	75 lm	700 lx	175 lx		
LEDGS50L20-XQ	Green, 520-535 nm	190 lm	1700 lx	425 lx		
LEDUV395S50L20-XQ	Ultraviolet, 395 nm	390 mW	.420 mW/cm ²	.105 mW/cm ²		

The following caution applies to blue LED models:

¹ Integral QD models only are listed. For integral 2 m (6.5 ft) PVC cable, omit suffix **XQ** from model number (example, **LEDRS50L5**). A model with a QD requires a mating cordset (see [5-Pin M12 Cordsets](#) on page 3).



**CAUTION:**
Risk Group 2: Possibly hazardous optical radiation emitted from this product.

Do not stare at the operating lamp. May be harmful to the eyes. Risk Group 2 (RG 2) products generally do not pose a realistic optical hazard if aversion responses limit the exposure duration or where lengthy exposures are unrealistic.

- IEC 62471

The following caution applies to ultraviolet models:

**CAUTION:**
Risk Group 2: UV Emitted from this product.

Eye or skin irritation may result from exposure. Use appropriate shielding and eye protection. Risk Group 2 (RG 2) products generally do not pose a realistic optical hazard if aversion responses limit the exposure duration or where lengthy exposures are unrealistic.

- IEC 62471

The following caution applies to LEDIS50L5-xx infrared models:

**CAUTION:**
Risk Group 1: IR Emitted from this product.

Use appropriate shielding or eye protection. Risk Group 1 (RG 1) products are safe for most use applications, except for very prolonged exposures where direct ocular exposures may be expected.

- IEC 62471

Wiring Table

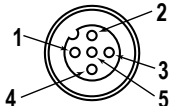
Wire Purpose	Cable Wire Color ²	Continuous On Mode	Strobed Mode	PresencePlus Pro Controller Terminal Block
Power Wires	Brown (1)	+12 V DC to 30 V DC	+12 V DC to 30 V DC	Pin 01 ³
	Blue (3)	common	common	Pin 02
Strobe Polarity Control	Gray (5)	open	Active Low: open	Open — Active Low
			Active High: connect to common (Blue wire)	Pin 02 — Active High
Strobe Voltage Wires	White (2)	open	0 V DC = ON (Active Low) +5 V DC to 30 V DC = OFF (Active Low) 0 V DC = OFF (Active High) +5 V DC to 30 V DC = ON (Active High)	Pin 04
	Black (4)	open	Strobe common	Pin 02
<p>Figure 1. Pinout for Mating Cordset</p> 			<p>Wiring Key</p> <p>1 = +12 V DC to 30 V DC 2 = Strobe (+) 3 = Common 4 = Strobe common 5 = Active high / Active Low</p>	

Specifications

Supply Voltage and Current

Operating voltage: 12 V DC to 30 V DC

Strobe voltage: 5 V DC to 30 V DC @ 15 mA max.

Current draw: 400 mA at 12 V, 160 mA at 30 V

See the electrical characteristics on the product label.

Supply Protection Circuitry

Protected against reverse polarity and transient voltages

Light Source

Three high-intensity LEDs; see models table for color temperature or wavelengths

Strobe

Optically isolated, 40 kHz max strobe frequency

5 µs minimum on time

Useful Life

When operating within specifications, output decreases less than 30% after 50,000 hours for visible and IR models and 20,000 hours for UV models

Construction

Black anodized aluminum housing

Acrylic window

Nickel-plated quick disconnect or PVC-jacketed cable

Black zinc-plated steel mounting nut

Mounting:

30 mm x 1.5 mm thread base mount

Environmental Rating

IP67

IP69K per DIN 40050-9



Note: Do not spray the cable with a high-pressure sprayer or cable damage will result.

Connections

Integral 5-pin M12 male quick-disconnect connector or 2 m (6.5 ft) integral PVC cable, depending on model

5-pin connecting cordset required for quick disconnect fitting models

Operating Conditions

-20 °C to +50 °C (-4 °F to +122 °F)

95% maximum relative humidity (non-condensing)

Storage Temperature: -40 °C to +70 °C (-40 °F to +158 °F)

Vibration and Mechanical Shock

All models meet MIL-STD-202F, Method 201A (Vibration: 10 Hz to 60 Hz maximum, 0.06 inch (1.52 mm) double amplitude, 10G maximum acceleration) requirements. Also meets IEC 60947-5-2 (Shock: 30G 11 ms duration, half sine wave) requirements.

Certifications



² For Banner-supplied wire.

³ When connecting the light to a PresencePLUS Pro controller terminal block, the controller supply must be 24 V DC ± 10%.

Beam Patterns

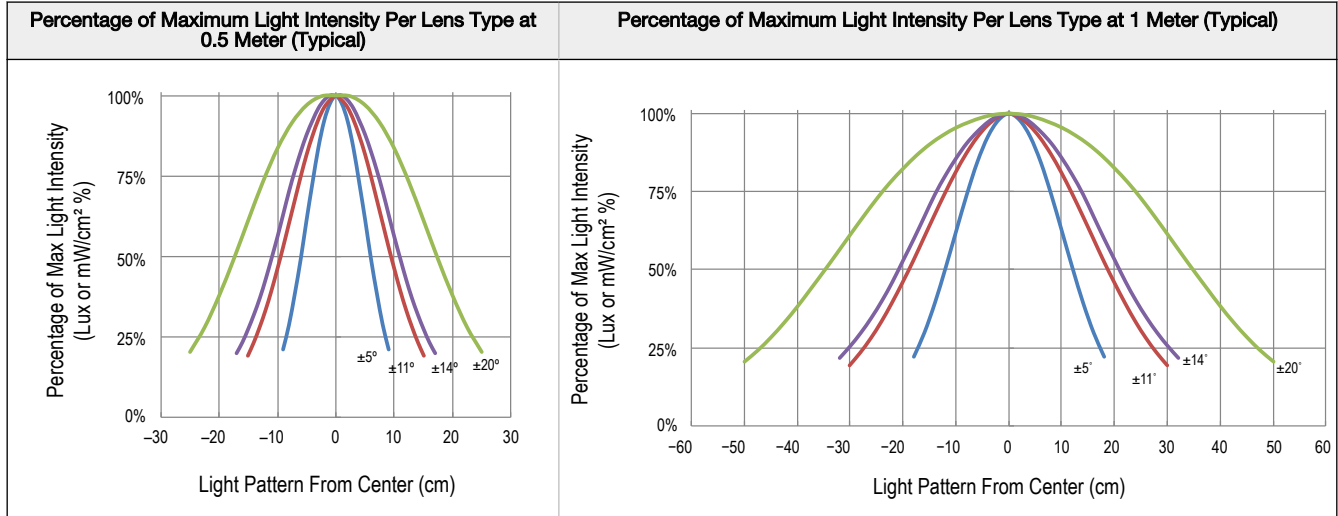

Dimensions

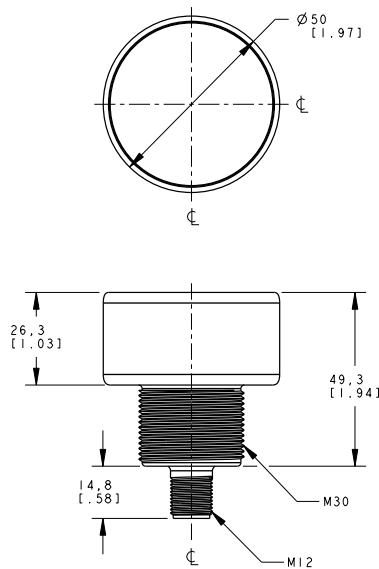

Accessories

5-Pin M12 Cordsets

5-Pin Threaded M12 Cordsets—Single Ended				
Model	Length	Style	Dimensions	Pinout (Female)
MQDC1-501.5	0.5 m (1.5 ft)	Straight		<p>1 = Brown 2 = White 3 = Blue 4 = Black 5 = Gray</p>
MQDC1-506	2 m (6.5 ft)			
MQDC1-515	5 m (16.4 ft)			
MQDC1-530	9 m (29.5 ft)			

5-Pin Threaded M12 Cordsets—Single Ended				
Model	Length	Style	Dimensions	Pinout (Female)
MQDC1-506RA	2 m (6.5 ft)	Right-Angle		
MQDC1-515RA	5 m (16.4 ft)			
MQDC1-530RA	9 m (29.5 ft)			

Mounting Brackets

All measurements are in mm

SMB30A

- Right-angle bracket with curved slot for versatile orientation
- Clearance for M6 (¼ in) hardware
- Mounting hole for 30 mm sensor
- 12-ga. stainless steel

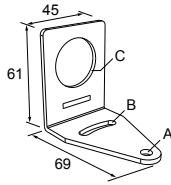

Hole center spacing: A to B=40
Hole size: A=ø 6.3, B= 27.1 x 6.3, C=ø 30.5

SMB30SC

- Swivel bracket with 30 mm mounting hole for sensor
- Black reinforced thermoplastic polyester
- Stainless steel mounting and swivel locking hardware included

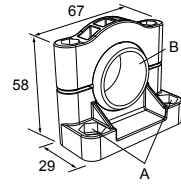

Hole center spacing: A=ø 50.8
Hole size: A=ø 7.0, B=ø 30.0

SMB30FA

- Swivel bracket with tilt and pan movement for precise adjustment
- Mounting hole for 30 mm sensor
- 12-ga. 304 stainless steel
- Easy sensor mounting to extrude rail T-slot
- Metric and inch size bolt available

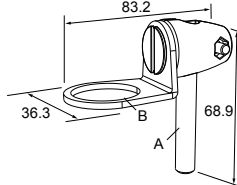

Bolt thread: SMB30FA, A= 3/8 - 16 x 2 in; SMB30FAM10, A= M10 - 1.5 x 50
Hole size: B= ø 30.1

SMBAMS30RA

- Right-angle SMBAMS series bracket
- 30 mm hole for mounting sensors
- Articulation slots for 90°+ rotation
- 12-ga. (2.6 mm) cold-rolled steel

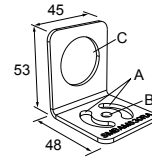

Hole center spacing: A=26.0, A to B=13.0
Hole size: A=26.8 x 7.0, B=ø 6.5, C=ø 31.0

SMB30MM

- 12-ga. stainless steel bracket with curved mounting slots for versatile orientation
- Clearance for M6 (¼ in) hardware
- Mounting hole for 30 mm sensor

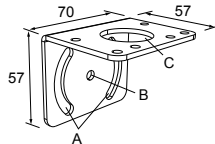

Hole center spacing: A = 51, A to B = 25.4
Hole size: A = 42.6 x 7, B = ø 6.4, C = ø 30.1

SMBAMS30P

- Flat SMBAMS series bracket
- 30 mm hole for mounting sensors
- Articulation slots for 90°+ rotation
- 12-ga. 300 series stainless steel

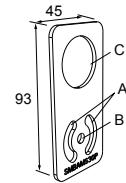

Hole center spacing: A=26.0, A to B=13.0
Hole size: A=26.8 x 7.0, B=ø 6.5, C=ø 31.0

Banner Engineering Corp. Limited Warranty

Banner Engineering Corp. warrants its products to be free from defects in material and workmanship for one year following the date of shipment. Banner Engineering Corp. will repair or replace, free of charge, any product of its manufacture which, at the time it is returned to the factory, is found to have been defective during the warranty period. This warranty does not cover damage or liability for misuse, abuse, or the improper application or installation of the Banner product.

THIS LIMITED WARRANTY IS EXCLUSIVE AND IN LIEU OF ALL OTHER WARRANTIES WHETHER EXPRESS OR IMPLIED (INCLUDING, WITHOUT LIMITATION, ANY WARRANTY OF MERCHANTABILITY OR FITNESS FOR A PARTICULAR PURPOSE), AND WHETHER ARISING UNDER COURSE OF PERFORMANCE, COURSE OF DEALING OR TRADE USAGE.

This Warranty is exclusive and limited to repair or, at the discretion of Banner Engineering Corp., replacement. **IN NO EVENT SHALL BANNER ENGINEERING CORP. BE LIABLE TO BUYER OR ANY OTHER PERSON OR ENTITY FOR ANY EXTRA COSTS, EXPENSES, LOSSES, LOSS OF PROFITS, OR ANY INCIDENTAL, CONSEQUENTIAL OR SPECIAL DAMAGES RESULTING FROM ANY PRODUCT DEFECT OR FROM THE USE OR INABILITY TO USE THE PRODUCT, WHETHER ARISING IN CONTRACT OR WARRANTY, STATUTE, TORT, STRICT LIABILITY, NEGLIGENCE, OR OTHERWISE.**

Banner Engineering Corp. reserves the right to change, modify or improve the design of the product without assuming any obligations or liabilities relating to any product previously manufactured by Banner Engineering Corp. Any misuse, abuse, or improper application or installation of this product or use of the product for personal protection applications when the product is identified as not intended for such purposes will void the product warranty. Any modifications to this product without prior express approval by Banner Engineering Corp will void the product warranties. All specifications published in this document are subject to change; Banner reserves the right to modify product specifications or update documentation at any time. Specifications and product information in English supersede that which is provided in any other language. For the most recent version of any documentation, refer to: www.bannerengineering.com.

For patent information, see www.bannerengineering.com/patents.

Mexican Importer

Banner Engineering de México, S. de R.L. de C.V.
 David Alfaro Siqueiros 103 Piso 2 Valle oriente
 San Pedro Garza García Nuevo León, C. P. 66269

81 8363.2714