

1-1452424-1 ✓ ACTIVE

AMP | MCON Interconnection System

TE Internal #: 1-1452424-1

PA, Brown, -40 – 125 °C [-40 – 257 °F] Operating Temperature,
MCON Interconnection System

[View on TE.com >](#)



Connectors > Connector Accessories > Connector Seals & Cavity Plugs



Primary Product Material: **PA**

Primary Product Color: **Brown**

Operating Temperature (Max): **65 °C, 70 °C, 75 °C, 80 °C, 85 °C, 90 °C, 100 °C, 105 °C, 110 °C, 120 °C, 125 °C [149 °F, 158 °F, 167 °F, 176 °F, 185 °F, 194 °F, 212 °F, 221 °F, 230 °F, 248 °F, 257 °F]**

Contains Lubricant: **No**

Operating Temperature Range: **-40 – 125 °C [-40 – 257 °F]**

Features

Body Features

Primary Product Material	PA
Primary Product Color	Brown

Usage Conditions

Operating Temperature (Max)	65 °C, 70 °C, 75 °C, 80 °C, 85 °C, 90 °C, 100 °C, 105 °C, 110 °C, 120 °C, 125 °C [149 °F] [158 °F][167 °F][176 °F][185 °F][194 °F][212 °F][221 °F][230 °F][248 °F][257 °F]
Operating Temperature Range	-40 – 125 °C[-40 – 257 °F]

Packaging Features

Packaging Quantity	30000
Packaging Method	Box

Other

Contains Lubricant	No
--------------------	----

Product Compliance

[For compliance documentation, visit the product page on TE.com>](#)

EU RoHS Directive 2011/65/EU	Compliant
EU ELV Directive 2000/53/EC	Compliant
China RoHS 2 Directive MIIT Order No 32, 2016	No Restricted Materials Above Threshold
EU REACH Regulation (EC) No. 1907/2006	Current ECHA Candidate List: JUNE 2023 (235) Candidate List Declared Against: JUNE 2023 (235) Does not contain REACH SVHC
Halogen Content	Low Halogen - Br, Cl, F, I < 900 ppm per homogenous material. Also BFR/CFR/PVC Free
Solder Process Capability	Not applicable for solder process capability

Product Compliance Disclaimer

This information is provided based on reasonable inquiry of our suppliers and represents our current actual knowledge based on the information they provided. This information is subject to change. The part numbers that TE has identified as EU RoHS compliant have a maximum concentration of 0.1% by weight in homogenous materials for lead, hexavalent chromium, mercury, PBB, PBDE, DBP, BBP, DEHP, DIBP, and 0.01% for cadmium, or qualify for an exemption to these limits as defined in the Annexes of Directive 2011/65/EU (RoHS2). Finished electrical and electronic equipment products will be CE marked as required by Directive 2011/65/EU. Components may not be CE marked. Additionally, the part numbers that TE has identified as EU ELV compliant have a maximum concentration of 0.1% by weight in homogenous materials for lead, hexavalent chromium, and mercury, and 0.01% for cadmium, or qualify for an exemption to these limits as defined in the Annexes of Directive 2000/53/EC (ELV). Regarding the REACH Regulation, the information TE provides on SVHC in articles for this part number is based on the latest European Chemicals Agency (ECHA) 'Guidance on requirements for substances in articles' posted at this URL: <https://echa.europa.eu/guidance-documents/guidance-on-reach>

Compatible Parts

 <p>TE Part # 9-1452380-9 96 POS. CONNECTOR ASSY</p>	 <p>TE Part # 9-1563173-9 96POS,MCON-1.2 CB,REC HSG,ASSY</p>	 <p>TE Part # 2278584-1 67 POS,MIXED,REC HSG,ASSY, SEALED TYPE180</p>	 <p>TE Part # 9-1452423-9 96 POS. CONNECTOR ASSY</p>
 <p>TE Part # 1-2005475-2 PCU SLD 105P PLUG ASSY(A-RH)</p>	 <p>TE Part # 1-2344950-1 95POS, HYBRID, REC HSG, ASSY, COD A</p>	 <p>TE Part # 1-2344951-2 104POS, MCON 1.2, REC HSG, ASSY, COD A</p>	 <p>TE Part # 2-2344950-1 95POS, HYBRID, REC HSG, ASSY, COD B</p>



TE Part # 2278584-2
67 POS,MIXED,REC HSG,ASSY,
SEALED TYPE45



TE Part # 4-1564285-1
58POS, MIXED,REC HSG,ASSY



TE Part # 7-1564285-4
58POS, MIXED,REC HSG,ASSY



TE Part # 8-1452423-7
96 POS. PCM CPNECTOR



TE Part # 9-1452415-7
58 POS MIXED, MCON CONNECTOR



TE Part # 1564285-7
58POS, MIXED,REC HSG,ASSY



TE Part # 2-1564284-0
96POS,MCON-1.2 CB,REC HSG,ASSY



TE Part # 2-1564284-5
96POS,MCON-1.2 CB,REC HSG,ASSY



TE Part # 3-1564284-7
96POS,MCON-1.2 CB,REC HSG,ASSY



TE Part # 3-1564284-8
96POS,MCON-1.2 CB,REC HSG,ASSY



TE Part # 3-1564285-2
58POS, MIXED,REC HSG,ASSY



TE Part # 3-1564285-6
58POS, MIXED,REC HSG,ASSY

Also in the Series | MCON Interconnection System



Automotive Connector Caps & Covers
(24)



Automotive Connector Locks &
Position Assurance(11)



Automotive Housings(318)

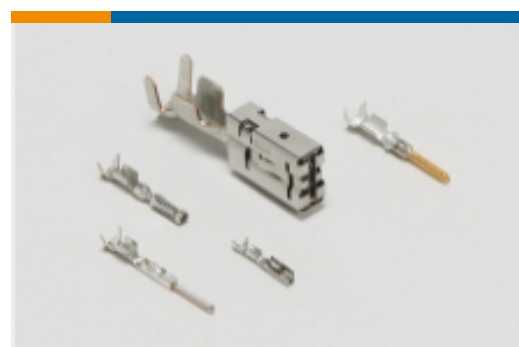

Automotive Terminals(121)



Connector Seals & Cavity Plugs(5)



Insertion & Extraction Tools(31)

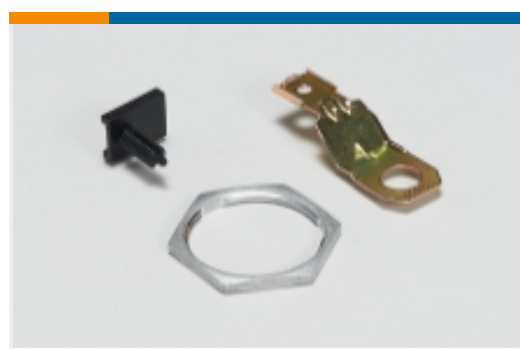

Other Automotive Connector
Accessories(7)



PCB Headers & Receptacles(1)

Customers Also Bought

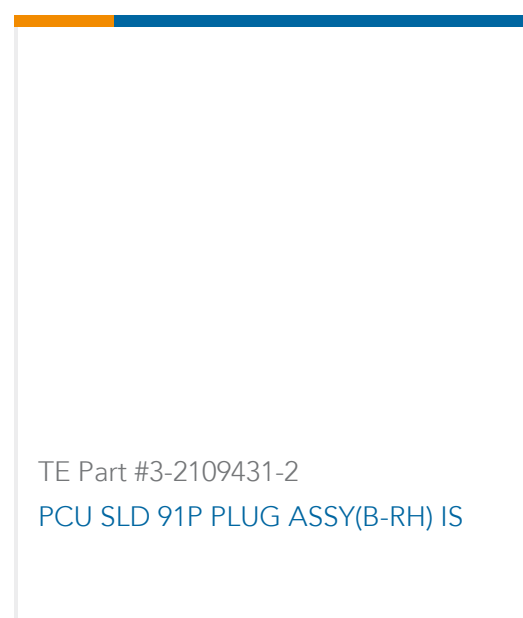
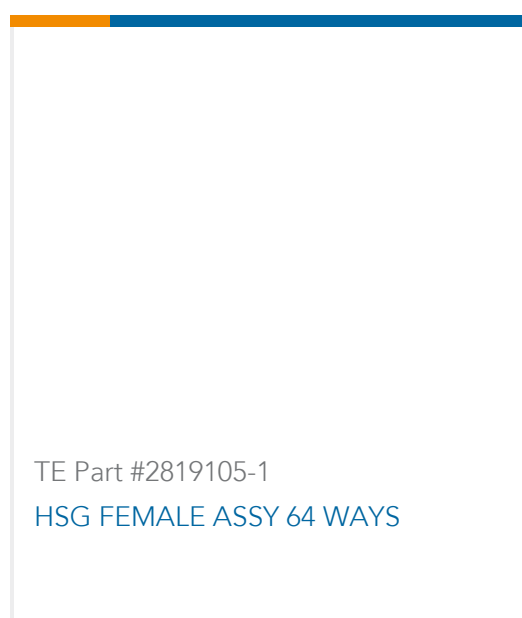
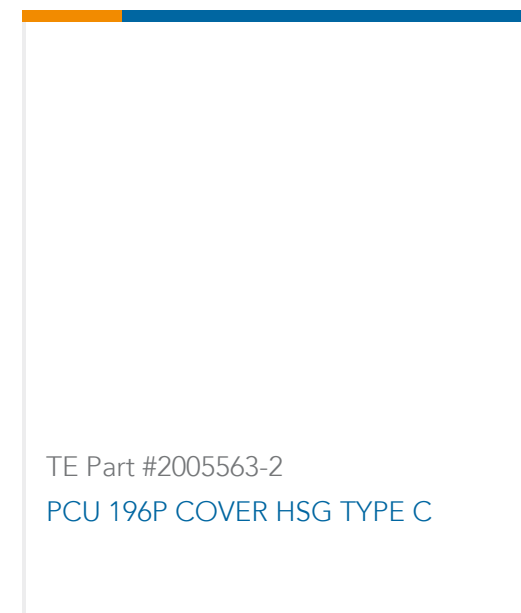
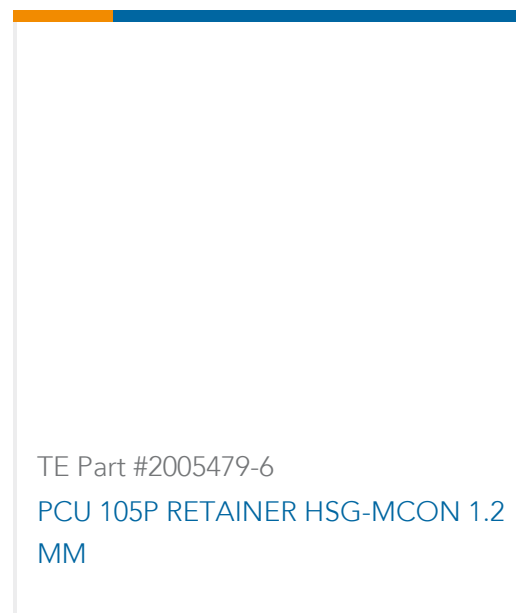
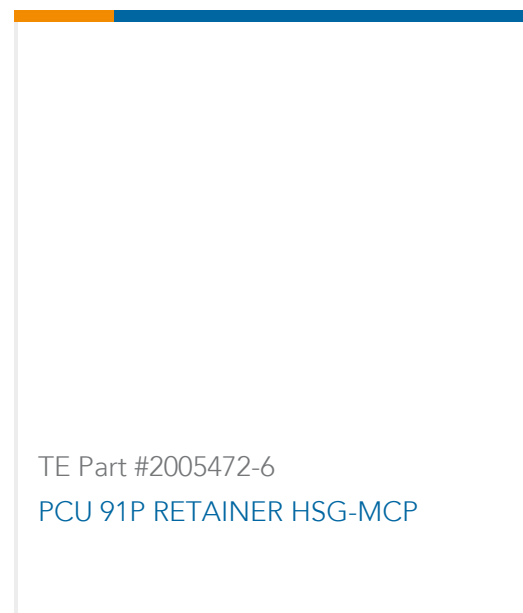
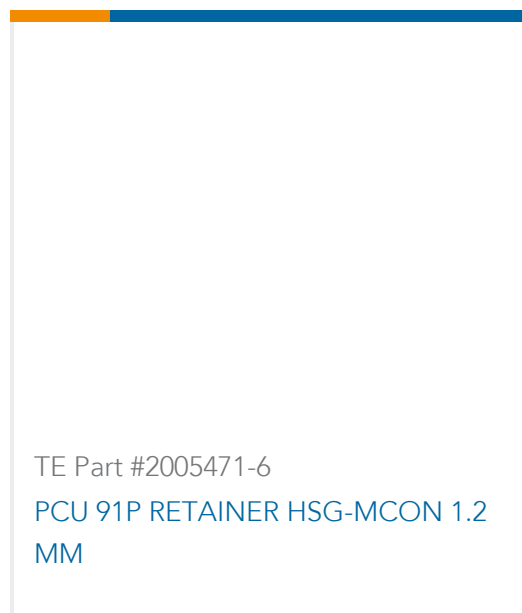
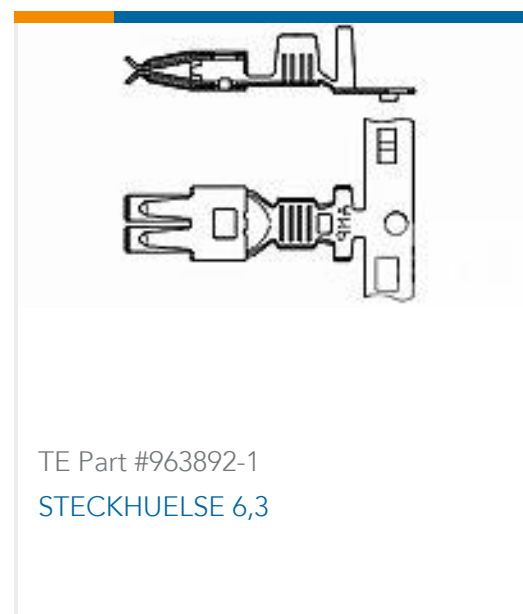

Documents

Product Drawings

[BLIND PLUG FOR MCON 1.2 CB \(0,](#)

English

CAD Files

[3D PDF](#)

[3D](#)

[Customer View Model](#)

[ENG_CVM_CVM_1-1452424-1_A.2d_dxf.zip](#)

English

[Customer View Model](#)

[ENG_CVM_CVM_1-1452424-1_A.3d_igs.zip](#)

English

[Customer View Model](#)

[ENG_CVM_CVM_1-1452424-1_A.3d_stp.zip](#)

English

By downloading the CAD file I accept and agree to the [Terms and Conditions](#) of use.

Product Specifications



Application Specification

English