

## IRENE-IR-25

~16° + 16° rectangular beam

### SPECIFICATION:

Dimensions	Ø 21.6 mm
Height	14.3 mm
Fastening	glue, pin
ROHS compliant	yes ⓘ



### MATERIALS:

Component	Type	Material	Colour	Finish
IRENE-25	Multi-lens	PMMA	clear	
IRENE-HLD	Holder	PC	white	

### ORDERING INFORMATION:

Component	Type	Qty in box	MOQ	MPQ	Box weight (kg)
CP13073_IRENE-IR-25 » Box size: 480 x 280 x 300 mm	Multi-lens	1792	336	112	0.0

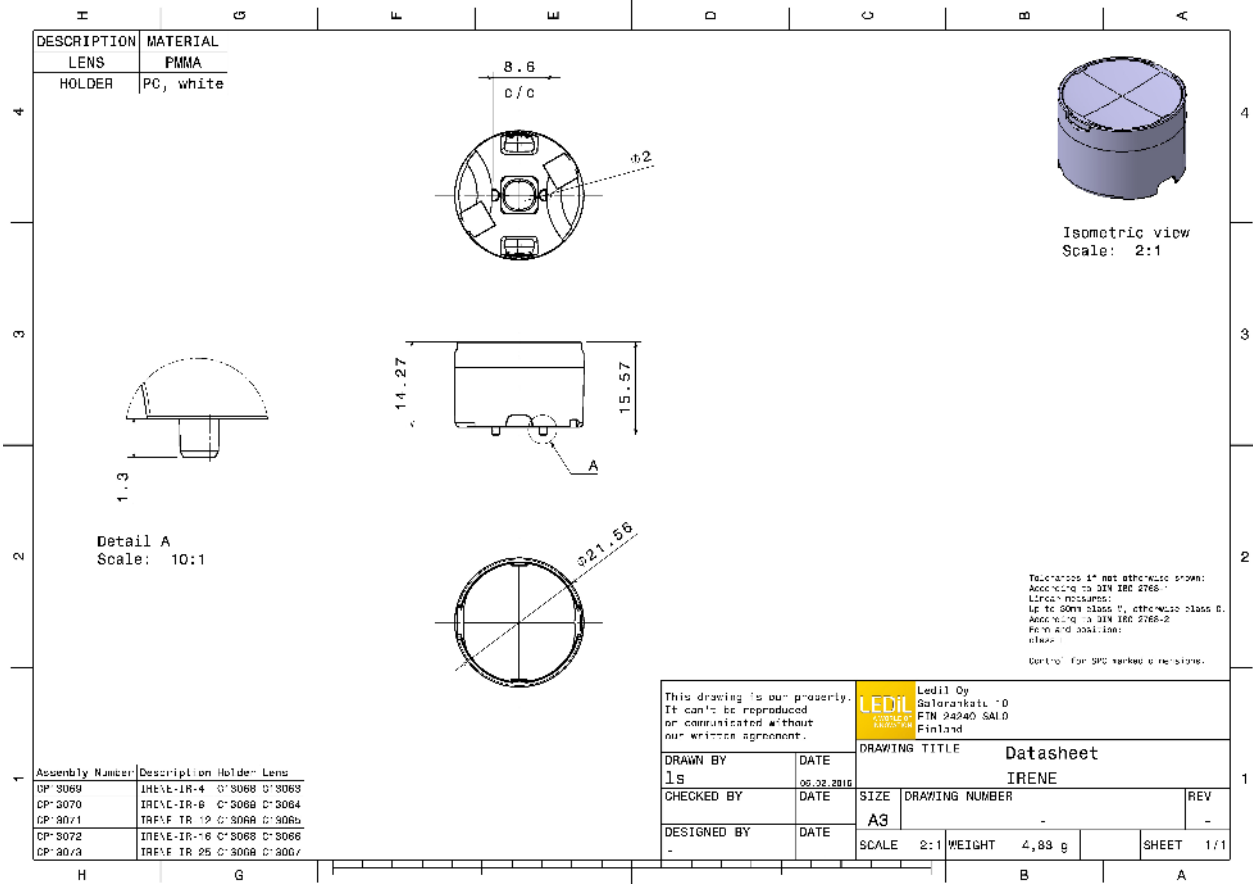

See also our general installation guide: [www.ledil.com/installation\\_guide](http://www.ledil.com/installation_guide)

## OPTICAL RESULTS (MEASURED):







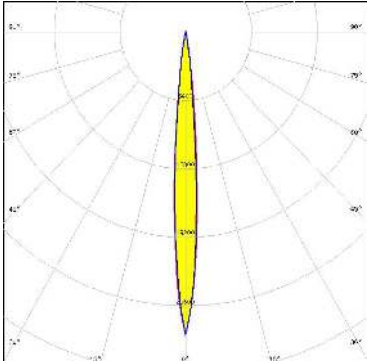

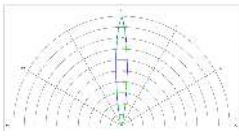
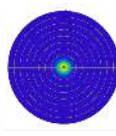
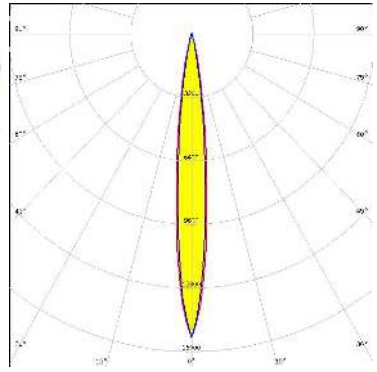

**OSRAM**  
Opto Semiconductors

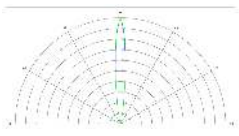
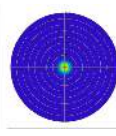
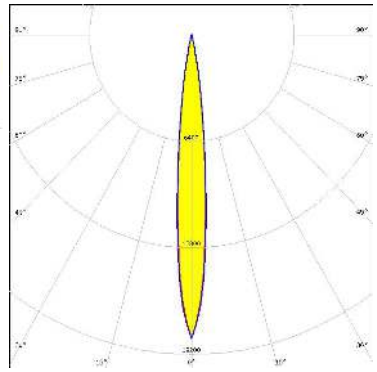
LED	SFH 4725S
FWHM / FWTM	16.0° / 26.0°
Efficiency	%
LEDs/each optic	1
Light colour	White
Required components:	

#### OPTICAL RESULTS (SIMULATED):

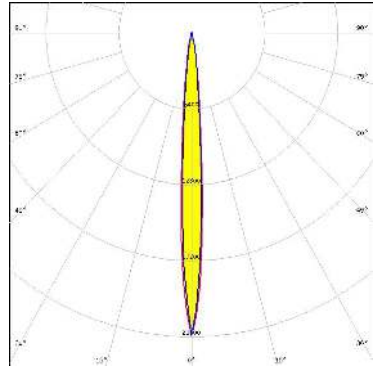
<p><b>LUMILEDS</b></p> <p>LED: LUXEON IR 2720            FWHM / FWTM: 9.0 + 8.0° / 18.0 + 17.0°            Efficiency: 97 %            LEDs/each optic: 1            Light colour: IR            Required components:</p>	
<p><b>LUMILEDS</b></p> <p>LED: LUXEON IR Compact            FWHM / FWTM: 9.0° / 17.0°            Efficiency: 86 %            LEDs/each optic: 1            Light colour: White            Required components:</p>	
<p><b>OSRAM</b>  <small>Opto Semiconductors</small></p> <p>LED: SFH 4715S            FWHM / FWTM: 11.0 + 9.0° / 20.0 + 18.0°            Efficiency: %            LEDs/each optic: 1            Light colour: White            Required components:</p>	
<p><b>OSRAM</b>  <small>Opto Semiconductors</small></p> <p>LED: SFH 4770S            FWHM / FWTM: 13.0 + 11.0° / 27.0 + 24.0°            Efficiency: 94 %            LEDs/each optic: 1            Light colour: White            Required components:</p>	

### OPTICAL RESULTS (SIMULATED):

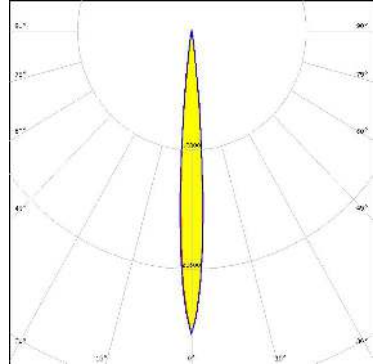
	<p>LED FWR1107MS            FWHM / FWTM 12.0 + 11.0° / 25.0 + 23.0°            Efficiency 95 %            LEDs/each optic 1            Light colour IR            Required components:</p>			
	<p>LED FWR1108MS            FWHM / FWTM 11.0° / 21.0°            Efficiency 96 %            LEDs/each optic 1            Light colour IR            Required components:</p>			
	<p>LED MFN1107MS            FWHM / FWTM 8.0° / 17.0°            Efficiency 94 %            Peak intensity 25.6 cd/lm            LEDs/each optic 1            Light colour IR            Required components:</p>			
	<p>LED MFN1108MS            FWHM / FWTM 8.0° / 16.0°            Efficiency 95 %            Peak intensity 32.7 cd/lm            LEDs/each optic 1            Light colour IR            Required components:</p>			

#### OPTICAL RESULTS (SIMULATED):

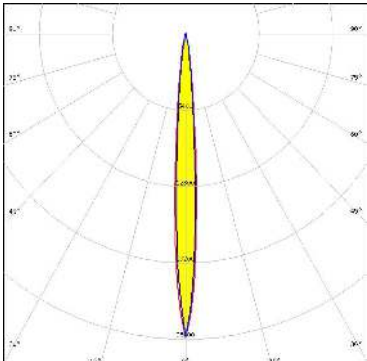
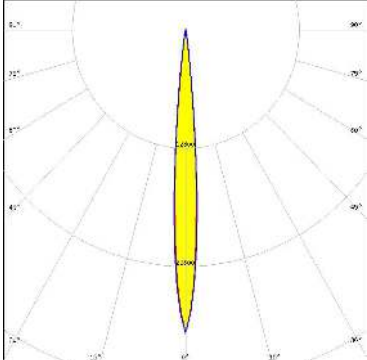
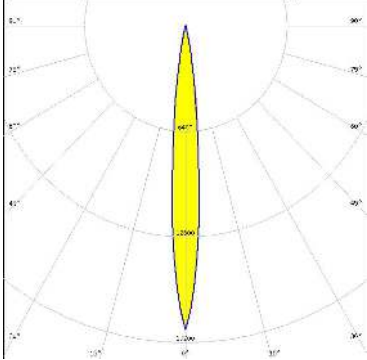
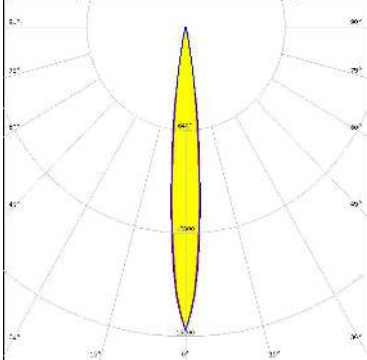
<p><b>STANLEY</b></p> <p>LED MGN1107MS</p> <p>FWHM / FWTM 8.0° / 17.0°</p> <p>Efficiency 94 %</p> <p>Peak intensity 25.5 cd/lm</p> <p>LEDs/each optic 1</p> <p>Light colour IR</p> <p>Required components:</p>	
<p><b>STANLEY</b></p> <p>LED MGN1108MS</p> <p>FWHM / FWTM 8.0° / 16.0°</p> <p>Efficiency 95 %</p> <p>Peak intensity 32.9 cd/lm</p> <p>LEDs/each optic 1</p> <p>Light colour IR</p> <p>Required components:</p>	
<p><b>STANLEY</b></p> <p>LED MJN1107MS</p> <p>FWHM / FWTM 10.0° / 22.0°</p> <p>Efficiency 96 %</p> <p>LEDs/each optic 1</p> <p>Light colour IR</p> <p>Required components:</p>	
<p><b>STANLEY</b></p> <p>LED MJN1108MS</p> <p>FWHM / FWTM 11.0° / 21.0°</p> <p>Efficiency 93 %</p> <p>LEDs/each optic 1</p> <p>Light colour IR</p> <p>Required components:</p>	

### GENERAL INFORMATION:

NOTE: The typical beam angle will be changed by different color, chip size and chip position tolerance. The typical total beam angle is the full angle measured where the luminous intensity is half of the peak value.

### MATERIALS:

As part of our continuous research and improvement processes, and to ensure the best possible quality and availability of our products, LEDiL reserves the right to change material grades without notice.

### PRODUCT DATA USER AGREEMENT AND DISCLAIMER:

The measured data in the provided downloadable LEDiL Product Datasheets and Mechanical 2D-Drawings is rounded and provided as reference for planning. LEDiL Oy's optical specifications have been verified by conducting performance testing of the products in accordance with the company's quality system. The reported data are averaged results of multiple measurements with typical variation. LEDiL Oy reserves the right to without prior notification make changes and improvements to its products.

LEDiL Oy assumes neither warranty, nor guarantee nor any other liability of any kind for the contents and correctness of the provided data. The provided data has been generated with highest diligence but the provided data may in reality not represent the complete possible variation range of all intrinsic parameters. Therefore, in certain cases a deviation from the provided data could occur.

LEDiL Oy reserves the right to undertake technical changes of its products without further notification which could lead to changes in the provided data. LEDiL Oy assumes no liability of any kind for the possible deviation from any provided data or any other damage resulting from the usage of the provided data.

The user agrees to this disclaimer and user agreement with the download or usage of the provided files.

#### LEDiL Oy

Joensuunkatu 13  
FI-24240 SALO  
Finland

#### LEDiL Inc.

228 West Page Street  
Suite D  
Sycamore IL 60178  
USA

#### Ledil Optics Technology (Shenzhen) Co., Ltd.

# 405 , Block B  
Casic Motor Building  
Shenzhen 518057  
P.R.CHINA

#### Local sales and technical support

[www.ledil.com/  
where\\_to\\_buy](http://www.ledil.com/where_to_buy)

#### Shipping locations

Salo, Finland  
Hong Kong, China

#### Distribution Partners

[www.ledil.com/  
where\\_to\\_buy](http://www.ledil.com/where_to_buy)