



SURFACE MOUNT

Power Splitter/Combiner **TCP-2-10-75X+**

Mini-Circuits

75Ω 2 Way-0° 5 to 1000 MHz

FEATURES

- Low insertion, 0.3 dB typ.
- Excellent amplitude unbalance, 0.2 dB typ.
- Very good phase unbalance, 1.0 deg. typ.
- External resistor & capacitor required
- Aqueous washable
- Leads for excellent solderability
- Low cost



Generic photo used for illustration purposes only

CASE STYLE: DB1627

+RoHS Compliant

The +Suffix identifies RoHS Compliance. See our web site for RoHS Compliance methodologies and qualifications

APPLICATIONS

- CATV
- Cellular

ELECTRICAL SPECIFICATIONS AT 25°C

Parameter	Frequency (MHz)	Min.	Typ.	Max.	Unit
Frequency Range		5		1000	MHz
Insertion Loss, above 3.0 dB	5 - 50	—	0.3	1.4	dB
	50 - 500	—	0.3	0.9	
	500 - 1000	—	0.6	1.3	
Isolation	5 - 50	14	24	—	dB
	50 - 500	19	29	—	
	500 - 1000	16	30	—	
Phase Unbalance	5 - 50	—	—	6.0	Degree
	50 - 500	—	—	4.0	
	500 - 1000	—	—	3.0	
Amplitude Unbalance	5 - 50	—	—	1.2	dB
	50 - 500	—	—	0.6	
	500 - 1000	—	—	0.5	

MAXIMUM RATINGS

Parameter	Ratings
Operating temperature	-40°C to 85°C
Storage temperature	-55°C to 100°C
RF Power Input (as splitter)	0.5 W max.

Permanent damage may occur if any of these limits are exceeded.

FUNCTIONAL SCHEMATIC

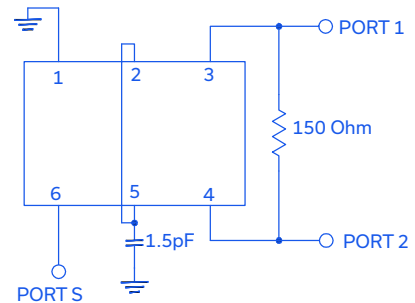

REV. C
ECO-018059
TCP-2-10-75X+
DY/TD/CP/AM
230605





SURFACE MOUNT

Power Splitter/Combiner **TCP-2-10-75X+**

PIN CONNECTIONS

SUM PORT	6
PORT 1	3
PORT 2	4
GROUND	1
CONNECT	2,5
EXT. RESISTOR 150Ω	3,4
EXT. CAPACITOR 1.5pF	2 OR 5 TO GND

PRODUCT MARKING: PB

**DEMO BOARD MCL P/N: TB-124
SUGGESTED PCB LAYOUT (PL-002)**

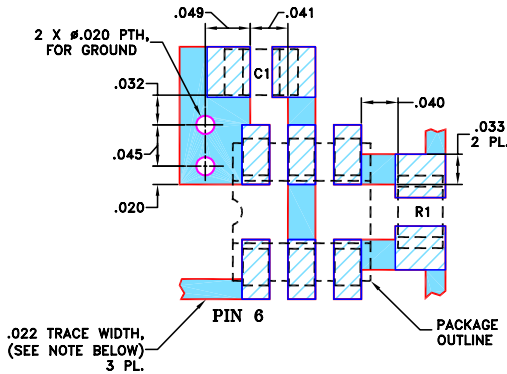

RESISTOR R1: 150 Ohm, 0805 SIZE
CAPACITOR C1: 1.5 pF, 0805 SIZE

- NOTES: 1. TRACE WIDTH IS SHOWN FOR ROGERS R04350B WITH DIELECTRIC THICKNESS $0.030" \pm 0.002"$; COPPER: 1 OZ. EACH SIDE. FOR OTHER MATERIALS TRACE WIDTH MAY NEED TO BE MODIFIED.
2. BOTTOM SIDE OF THE PCB IS CONTINUOUS GROUND PLANE.
- DENOTES PCB COPPER LAYOUT WITH SMOBC (SOLDER MASK OVER BARE COPPER)
 - DENOTES COPPER LAND PATTERN FREE OF SOLDER MASK

OUTLINE DRAWING

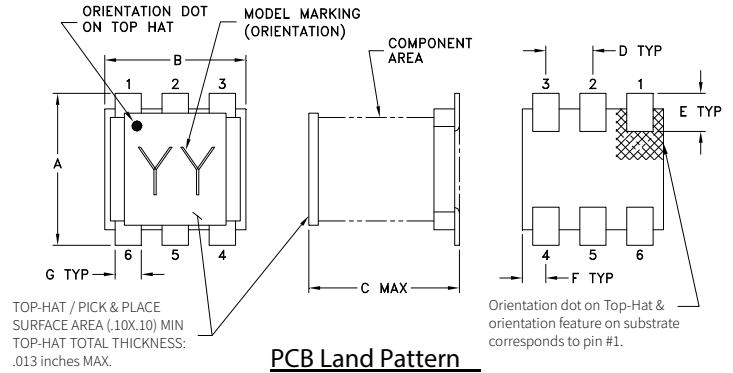

PCB Land Pattern

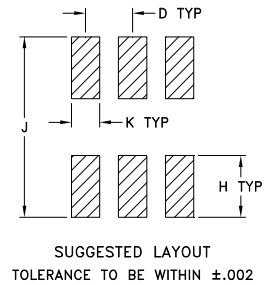

OUTLINE DIMENSIONS (Inches mm)

A	B	C	D	E	F
.160	.150	.160	.050	.040	.025
4.06	3.81	4.06	1.27	1.02	0.64
G	H	J	K	wt	
.028	.065	.190	.030	grams	
0.71	1.65	4.83	0.76	0.15	

TAPE & REEL INFORMATION: F47



SURFACE MOUNT

Power Splitter/Combiner TCP-2-10-75X+

Mini-Circuits

TYPICAL PERFORMANCE DATA AT 25°C

Frequency (MHz)	Total Loss ¹ (dB)		Amplitude Unbalance (dB)	Isolation (dB)	Phase Unbalance (deg.)	VSWR (:1)		
	S-1	S-2				S	1	2
5.00	3.14	3.32	0.19	27.67	0.39	1.02	1.16	1.21
8.00	3.13	3.31	0.18	28.39	0.22	1.01	1.15	1.19
10.00	3.13	3.32	0.18	28.59	0.14	1.01	1.14	1.19
20.00	3.14	3.32	0.18	28.82	0.06	1.00	1.14	1.18
35.00	3.14	3.32	0.19	28.77	0.04	1.00	1.14	1.18
50.00	3.14	3.33	0.18	28.68	0.01	1.00	1.14	1.18
80.00	3.15	3.33	0.18	28.61	0.08	1.01	1.13	1.17
110.00	3.16	3.34	0.18	28.60	0.16	1.02	1.13	1.17
150.00	3.17	3.35	0.18	28.65	0.12	1.03	1.12	1.16
350.00	3.21	3.39	0.18	28.62	0.20	1.10	1.11	1.10
550.00	3.25	3.40	0.15	26.72	0.34	1.21	1.17	1.13
650.00	3.27	3.41	0.14	25.16	0.31	1.27	1.23	1.19
750.00	3.34	3.47	0.13	23.56	0.39	1.33	1.30	1.26
900.00	3.54	3.65	0.11	21.40	0.55	1.40	1.41	1.36
1000.00	3.71	3.80	0.09	20.18	0.68	1.44	1.48	1.42

1. Total Loss = Insertion Loss + 3dB splitter loss.

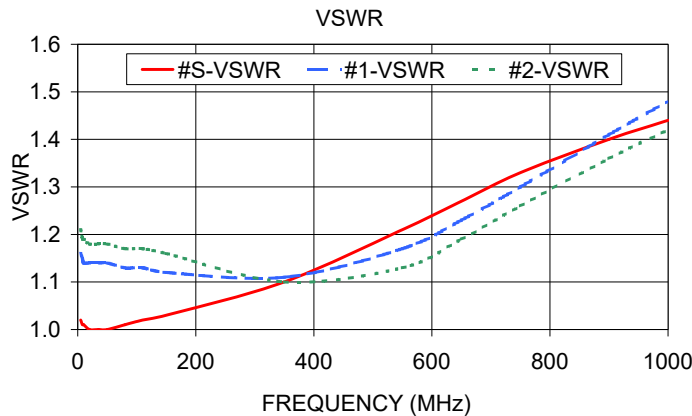
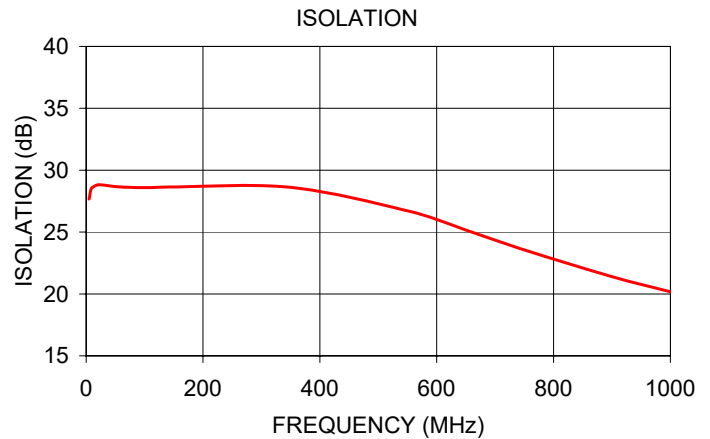
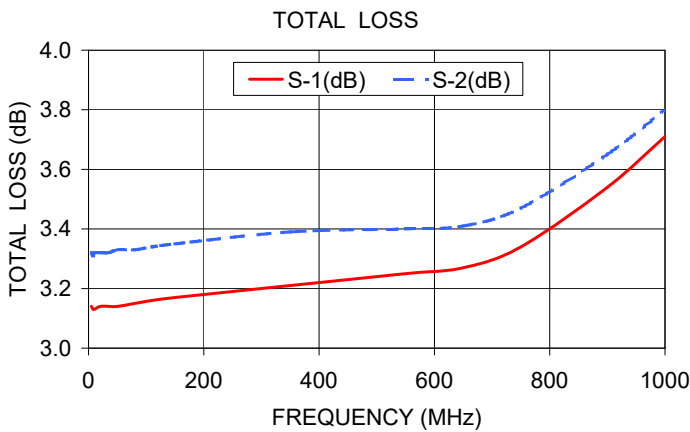

- NOTES**
- A. Performance and quality attributes and conditions not expressly stated in this specification document are intended to be excluded and do not form a part of this specification document.
 - B. Electrical specifications and performance data contained in this specification document are based on Mini-Circuit's applicable established test performance criteria and measurement instructions.
 - C. The parts covered by this specification document are subject to Mini-Circuits standard limited warranty and terms and conditions (collectively, "Standard Terms"); Purchasers of this part are entitled to the rights and benefits contained therein. For a full statement of the standard. Terms and the exclusive rights and remedies thereunder, please visit Mini-Circuits' website at www.minicircuits.com/MCLStore/terms.jsp

