

1.5 A, Very Low-Dropout (VLDO) Fast Transient Response Regulator Series

NCP59150, NCV59150 Series

The NCP59150 series are high precision, very low dropout (VLDO), low ground current positive voltage regulators that are capable of providing an output current in excess of 1.5 A with a typical dropout voltage lower than 300 mV at 1.5 A load current. The devices are stable with ceramic output capacitors. This series consists of Adjustable output voltage and fixed voltage versions.

The NCP59150 series can withstand up to 18 V max input voltage.

Internal protection features consist of output current limiting, built-in thermal shutdown and reverse output current protection. Logic level enable and error flag pins are available on the 5-pin and 8-pin versions.

The NCP59150 series Adjustable Voltage devices are available in D2PAK-5 and DFN8 packages, the Fixed Voltage option are available in D2PAK-5, D2PAK-3 and DFN8 packages.

Features

- Output Current in Excess of 1.5 A
- 300 mV Typical Dropout Voltage at 1.5 A
- Adjustable and Fixed Output Voltage Options
- Low Ground Current
- Fast Transient Response
- Stable with Ceramic Output Capacitor
- Logic Compatible Enable and Error Flag Pins
- Current Limit, Reverse Current and Thermal Shutdown Protection
- Operation up to 13.5 V Input Voltage
- NCV Prefix for Automotive and Other Applications Requiring Unique Site and Control Change Requirements; AEC-Q100 Qualified and PPAP Capable
- These are Pb-Free Devices

Applications

- Consumer and Industrial Equipment Point of Regulation
- Servers and Networking Equipment
- FPGA, DSP and Logic Power Supplies
- Switching Power Supply Post Regulation
- Battery Chargers
- Functional Replacement for Industry Standard MIC29150, MIC39150, MIC37150

MARKING DIAGRAMS

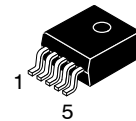

D²PAK
CASE 936A

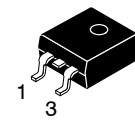
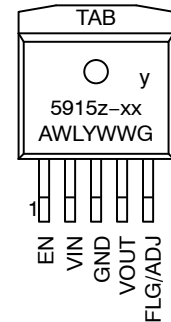

D²PAK3
CASE 936

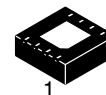
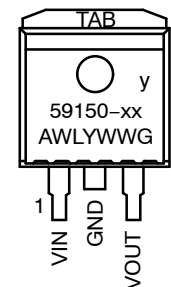

DFN8
CASE 488AF

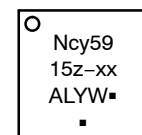

xx = Voltage Version
y = P (NCP), V (NCV)
z = 1 (Fix Voltage), 2 (Adj)
A = Assembly Location
L, WL = Wafer Lot
Y, YY = Year
W, WW = Work Week
G, ■ = Pb-Free Package
(Note: Microdot may be in either location)

ORDERING INFORMATION

See detailed ordering and shipping information in the package dimensions section on page 9 of this data sheet.

NCP59150, NCV59150 Series

TYPICAL APPLICATIONS

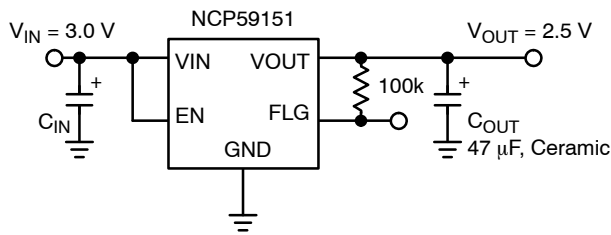

Figure 1. Fixed 2.5 Regulator with Error Flag

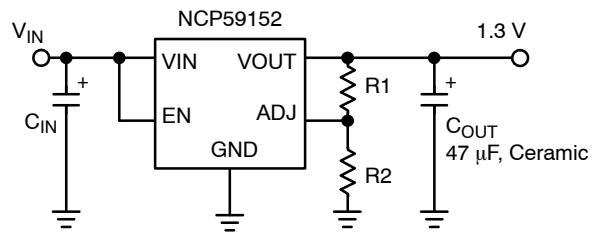

Figure 2. Adjustable Regulator

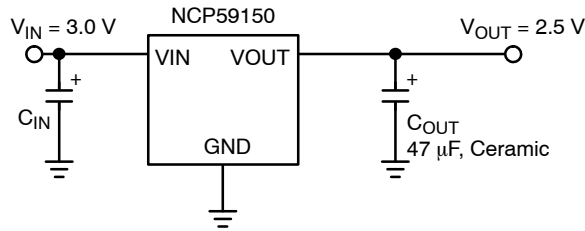

Figure 3. Fixed 2.5 Regulator in D²PAK-3 Package

PIN FUNCTION DESCRIPTION

Pin Number D2PAK-5	Pin Number D2PAK-3	Pin Number DFN8	Pin Name	Pin Function
1	-	2	EN	Enable Input: CMOS and TTL logic compatible. Logic high = enable; Logic low = shutdown.
2	1	3	VIN	Input voltage which supplies both the internal circuitry and the current to the output load.
3	2	1	GND	Ground
TAB	TAB	-	TAB	TAB is connected to ground.
4	3	6	VOUT	Linear Regulator Output.
5 (Fixed)	-	8	FLG	Error Flag Open collector output. Active-low indicates an output fault condition.
5 (Adj)	-	7 (Adj)	ADJ	Adjustable Regulator Feedback Input. Connect to output voltage resistor divider central node.
-	-	7 (Fixed)	VOUT SENSE	Fixed Voltage Regulator Feedback Input. Connect to output voltage node.
-	-	EP	EXPOSED PAD	PAD for removing heat from the device. Must be connected to GND.
-	-	4, 5	NC	Not internally connected.

NCP59150, NCV59150 Series

ABSOLUTE MAXIMUM RATINGS

Symbol	Rating	Value	Unit
V _{IN}	Supply Voltage	0 to 18	V
V _{EN}	Enable Input Voltage	0 to 18	V
V _{FLG}	Error Flag Open Collector Output Maximum Voltage	0 to 18	V
V _{OUT} – V _{IN}	Reverse V _{OUT} – V _{IN} Voltage (EN = Shutdown or Vin = 0 V) (Note 1)	0 to 6.5	V
P _D	Power Dissipation (Notes 2 and 5)	Internally Limited	
T _J	Junction Temperature	-40 ≤ T _J ≤ +125	°C
T _S	Storage Temperature	-65 ≤ T _J ≤ +150	°C
	ESD Rating (Notes 3 and 4)	Human Body Model Machine Model	2000 200

Stresses exceeding those listed in the Maximum Ratings table may damage the device. If any of these limits are exceeded, device functionality should not be assumed, damage may occur and reliability may be affected.

NOTE: All voltages are referenced to GND pin unless otherwise noted.

- The ENABLE pin input voltage must be ≤ 0.8 V or Vin must be connected to ground potential.
- $P_{D(max)} = (T_{J(max)} - T_A) / R_{\theta JA}$, where $R_{\theta JA}$ depends upon the printed circuit board layout.
- Devices are ESD sensitive. Handling precautions recommended..
- This device series incorporates ESD protection and is tested by the following methods:
ESD Human Body Model (HBM) tested per AEC-Q100-002 (EIA/JESD22-A114C)
ESD Machine Model (MM) tested per AEC-Q100-003 (EIA/JESD22-A115C)
This device contains latch-up protection and exceeds 100 mA per JEDEC Standard JESD78.
- This protection is not guaranteed outside the Recommended Operating Conditions.

RECOMMENDED OPERATING CONDITIONS (Note 6)

Symbol	Rating	Value	Unit
V _{IN}	Supply Voltage	2.24 to 13.5	V
V _{EN}	Enable Input Voltage	0 to 13.5	V
V _{FLG}	Error Flag Open Collector Voltage	0 to 13.5	V
T _J	Junction Temperature	-40 ≤ T _J ≤ +125	°C

- The device is not guaranteed to function outside it's Recommended operating conditions.

NCP59150, NCV59150 Series

ELECTRICAL CHARACTERISTICS

$T_J = 25^\circ\text{C}$ with $V_{IN} = V_{OUT\text{ nominal}} + 1\text{ V}$; $V_{EN} = V_{IN}$; $I_L = 10\text{ mA}$; bold values indicate $-40^\circ\text{C} < T_J < +125^\circ\text{C}$, unless noted.

Parameter	Conditions	Min	Typ	Max	Unit
Output Voltage Accuracy DFN package	$I_L = 10\text{ mA}$	-1		1	%
	$10\text{ mA} < I_{OUT} < 1.5\text{ A}$, $V_{OUT\text{ nominal}} + 1 \leq V_{IN} \leq 13.5\text{ V}$	-2		2	%
Output Voltage Accuracy D2PAK package	$I_L = 10\text{ mA}$	-1.5		1.5	%
	$10\text{ mA} < I_{OUT} < 1.5\text{ A}$, $V_{OUT\text{ nominal}} + 1 \leq V_{IN} \leq 13.5\text{ V}$	-2.5		2.5	%
Output Voltage Line Regulation	$V_{IN} = V_{OUT\text{ nominal}} + 1.0\text{ V}$ to 13.5 V ; $I_L = 10\text{ mA}$		0.02	0.5	%
Output Voltage Load Regulation	$I_L = 10\text{ mA}$ to 1.5 A		0.2	1.0	%
$V_{IN} - V_{OUT}$ Dropout Voltage (Note 7)	$I_L = 750\text{ mA}$		175	350	mV
	$I_L = 1.5\text{ A}$		300	500	mV
Ground Pin Current (Note 8)	$I_L = 1.5\text{ A}$		40	60 80	mA
Ground Pin Current in Shutdown	$V_{EN} \leq 0.5\text{ V}$		1.0	5.0	μA
Overload Protection Current Limit	$V_{OUT} = 0\text{ V}$		2.0	3.0	A
Start-up Time	$V_{EN} = V_{IN}$, $V_{OUT\text{ nominal}} = 2.5\text{ V}$, $I_{OUT} = 10\text{ mA}$, $C_{OUT} = 47\text{ }\mu\text{F}$		100	500	μs
Output Voltage Start-up Slope Fixed Voltage Devices	$V_{EN} = V_{IN}$, $I_{OUT} = 10\text{ mA}$, $C_{OUT} = 47\text{ }\mu\text{F}$ (Note 9)		40	200	$\mu\text{s/V}$

ENABLE INPUT

Enable Input Signal Levels	Regulator Enable	1.8			V
	Regulator Shutdown			0.8	V
Enable Pin Input Current	$V_{EN} \leq 0.8\text{ V}$ (Regulator Shutdown)			2.0 4.0	μA
	$6.5\text{ V} > V_{EN} \geq 1.8\text{ V}$ (Regulator enable)	1.0	15	30 40	μA

FLAG OUTPUT

$I_{FLG(\text{leak})}$	$V_{oh} = 13.5\text{ V}$, Flag OFF			1.0 2.0	μA
$V_{FLG(\text{Lo})}$	$V_{IN} = 2.24\text{ V}$, $I_{FLG} = 1\text{ mA}$, Flag ON		210	400 500	mV
V_{FLG}	Low Threshold, % of particular V_{OUT}	93	95		%
	Hysteresis, % of particular V_{OUT}		2		%
	High Threshold, % of particular V_{OUT}		97	99.2	%

NCP/NCV59152 ADJ VOLTAGE DEVICES ONLY

Reference Voltage	DFN Package	1.228 1.215	1.240	1.252 1.265	V
	D ² PAK Package	1.221 1.209	1.240	1.259 1.271	
Adjust Pin Bias Current			100	200 350	nA

7. $V_{DO} = V_{IN} - V_{OUT}$ when V_{OUT} decreases to 98% of its nominal output voltage with $V_{IN} = V_{OUT} + 1\text{ V}$. For output voltages below 1.74 V, dropout voltage specification does not apply due to a minimum input operating voltage of 2.24 V.

8. $I_{IN} = I_{GND} + I_{OUT}$.

9. Fixed Voltage Device Start-up Time = Output Voltage Start-up Slope * $V_{OUT\text{ nominal}}$.

Package	Conditions / PCB Footprint	Thermal Resistance
D2PAK-3, Junction-to-Case		$R_{\theta JC} = 2.1^\circ\text{C/W}$
D2PAK-5, Junction-to-Case		$R_{\theta JC} = 2.1^\circ\text{C/W}$
D2PAK-3, Junction-to-Air	PCB with 100 mm ² 2.0 oz Copper Heat Spreading Area	$R_{\theta JA} = 52^\circ\text{C/W}$
D2PAK-5, Junction-to-Air	PCB with 100 mm ² 2.0 oz Copper Heat Spreading Area	$R_{\theta JA} = 52^\circ\text{C/W}$
DFN8, Junction-to-Air	PCB with 500 mm ² 2.0 oz Copper Heat Spreading Area	$R_{\theta JA} = 75^\circ\text{C/W}$

NCP59150, NCV59150 Series

TYPICAL CHARACTERISTICS

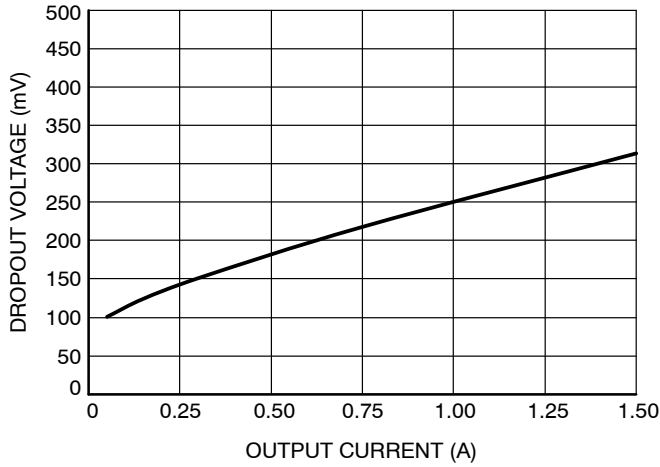

Figure 4. Dropout Voltage vs. Output Current
($V_{OUTnom} = 2.5\text{ V}$)

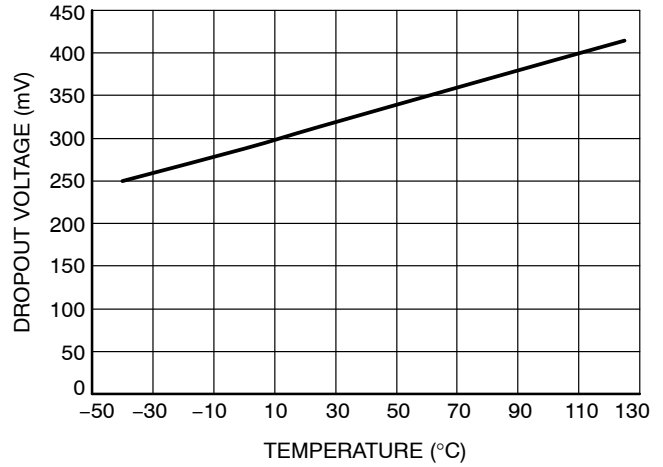

Figure 5. Dropout Voltage vs. Temperature
($V_{OUTnom} = 2.5\text{ V}$, $I_{OUT} = 1.5\text{ A}$)

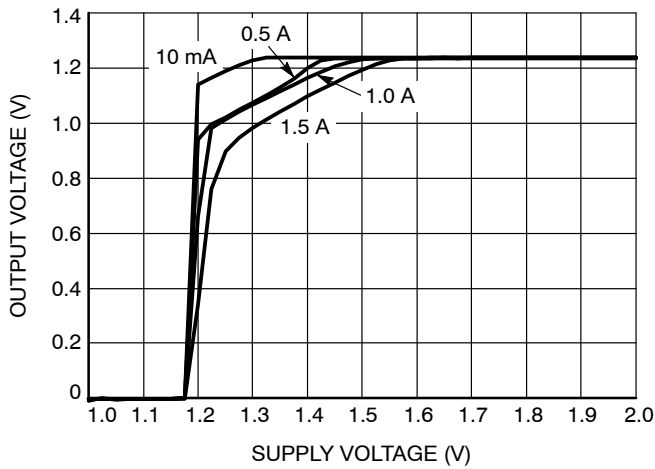

Figure 6. Dropout Characteristics
($V_{OUTnom} = 1.24\text{ V}$)

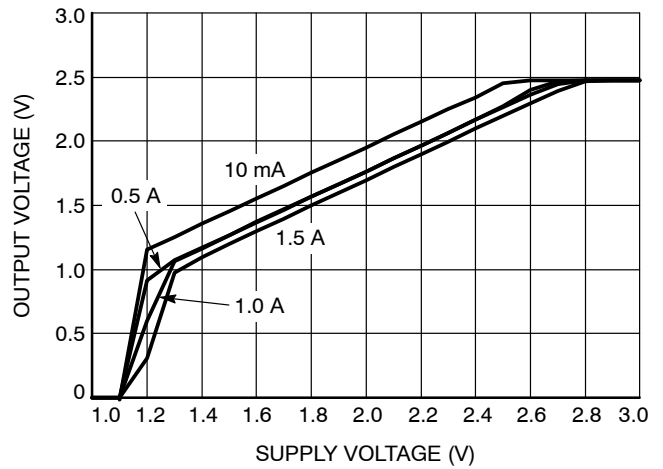

Figure 7. Dropout Characteristics
($V_{OUTnom} = 2.5\text{ V}$)

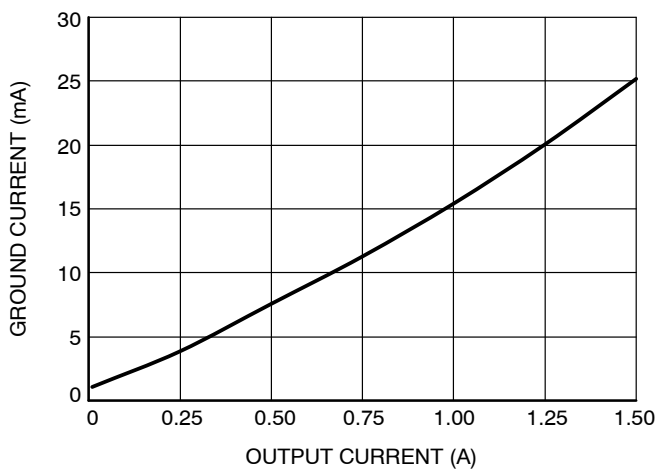

Figure 8. Ground Current vs. Output Current
($V_{OUTnom} = 1.24\text{ V}$)

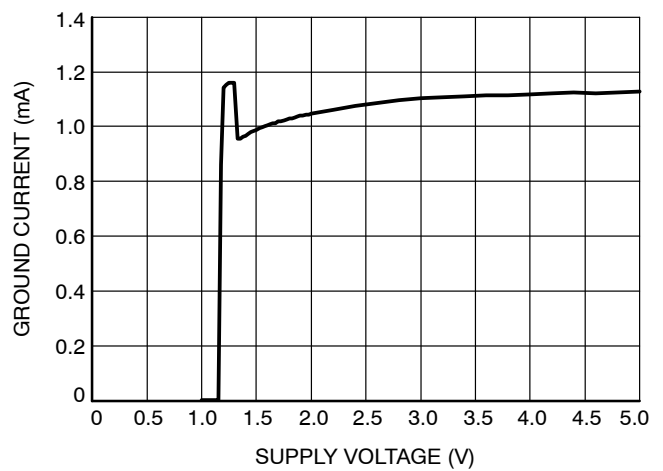

Figure 9. Ground Current vs. Supply Voltage
($V_{OUTnom} = 1.24\text{ V}$, $I_{OUT} = 10\text{ mA}$)

NCP59150, NCV59150 Series

TYPICAL CHARACTERISTICS

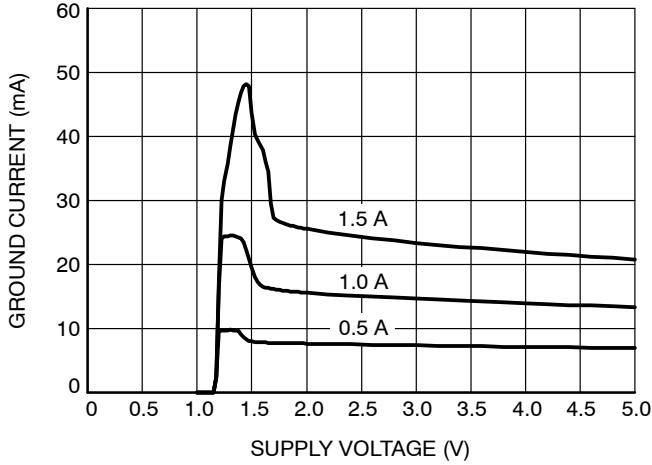

Figure 10. Ground Current vs. Supply Voltage
($V_{OUTnom} = 1.24\text{ V}$)

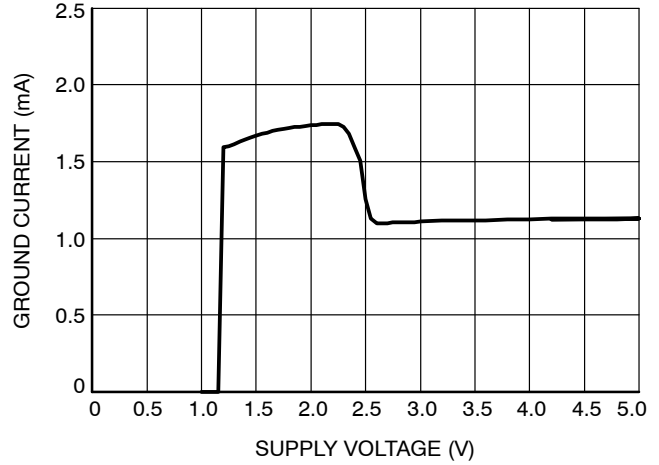

Figure 11. Ground Current vs. Supply Voltage
($V_{OUTnom} = 2.5\text{ V}$, $I_{OUT} = 10\text{ mA}$)

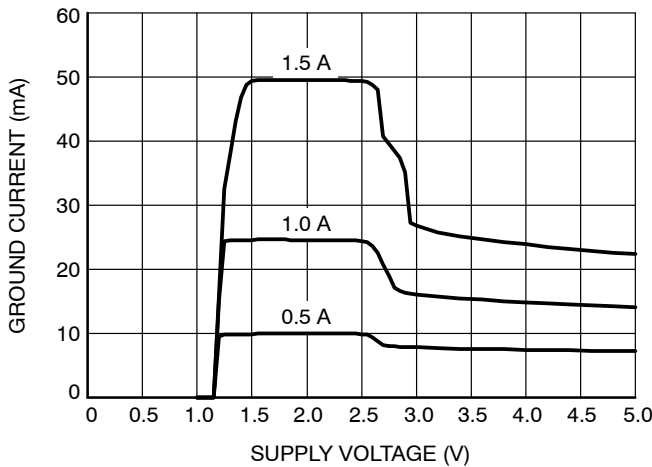

Figure 12. Ground Current vs. Supply Voltage
($V_{OUTnom} = 2.5\text{ V}$)

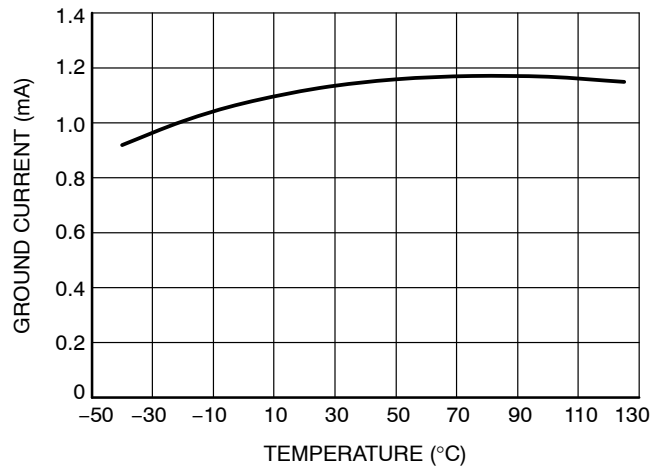

Figure 13. Ground Current vs. Temperature
($V_{OUTnom} = 2.5\text{ V}$, $I_{OUT} = 10\text{ mA}$, $V_{IN} = 3.5\text{ V}$)

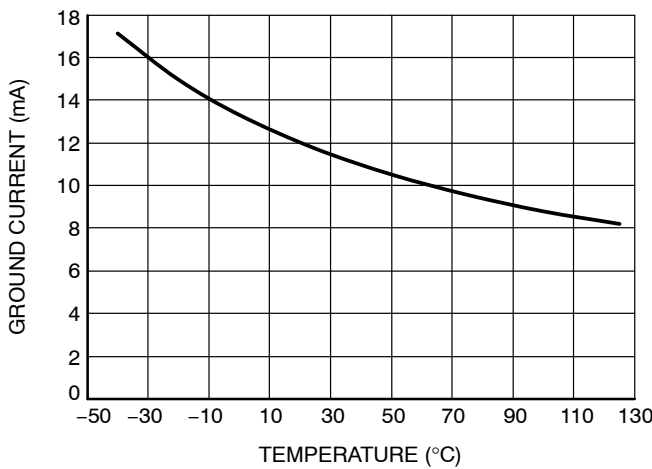

Figure 14. Ground Current vs. Temperature
($V_{OUTnom} = 2.5\text{ V}$, $I_{OUT} = 0.75\text{ A}$, $V_{IN} = 3.5\text{ V}$)

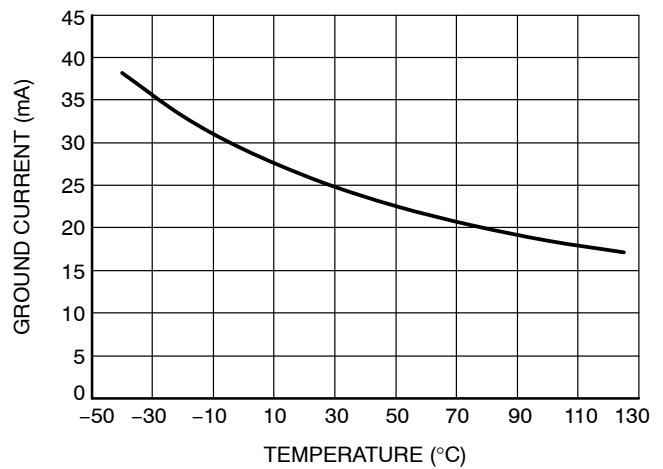

Figure 15. Ground Current vs. Temperature
($V_{OUTnom} = 2.5\text{ V}$, $I_{OUT} = 1.5\text{ A}$, $V_{IN} = 3.5\text{ V}$)

NCP59150, NCV59150 Series

TYPICAL CHARACTERISTICS

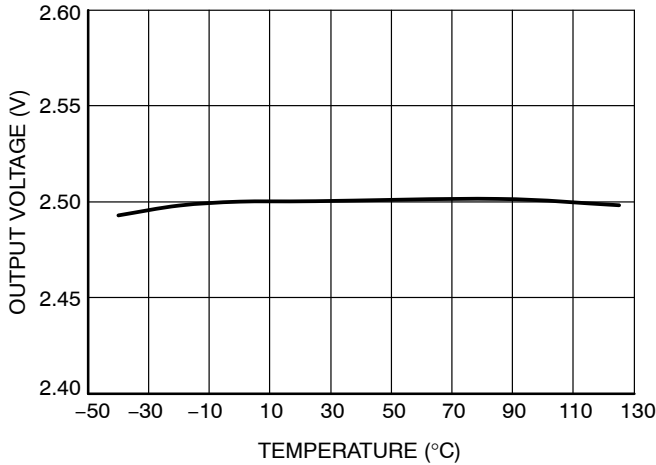

Figure 16. Output Voltage vs. Temperature
 $(V_{OUTnom} = 2.5\text{ V}, I_{OUT} = 10\text{ mA})$

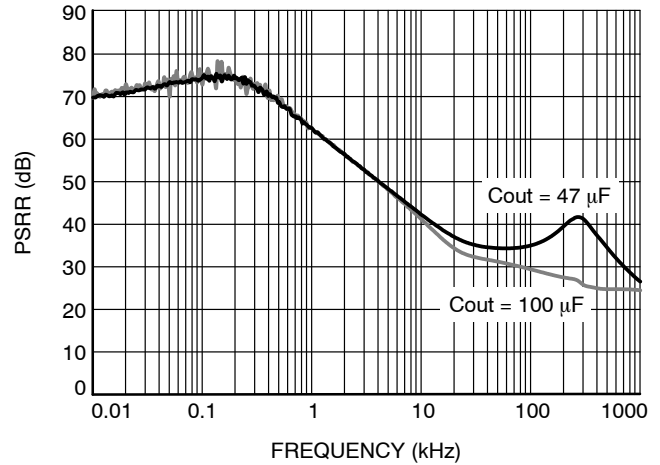

Figure 17. PSRR vs. Frequency, $V_{in} = 3.5\text{ V} + 200\text{ mVpp}$ Modulation, $V_{out} = 2.5\text{ V}$, $I_{out} = 0.5\text{ A}$

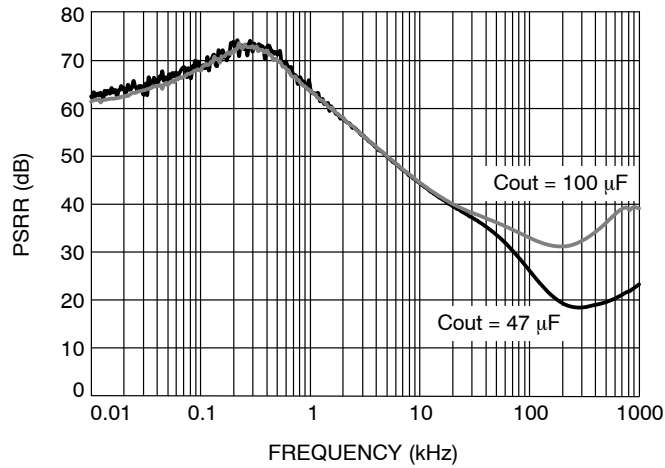

Figure 18. PSRR vs. Frequency, $V_{in} = 3.5\text{ V} + 200\text{ mVpp}$ Modulation, $V_{out} = 2.5\text{ V}$, $I_{out} = 1.5\text{ A}$

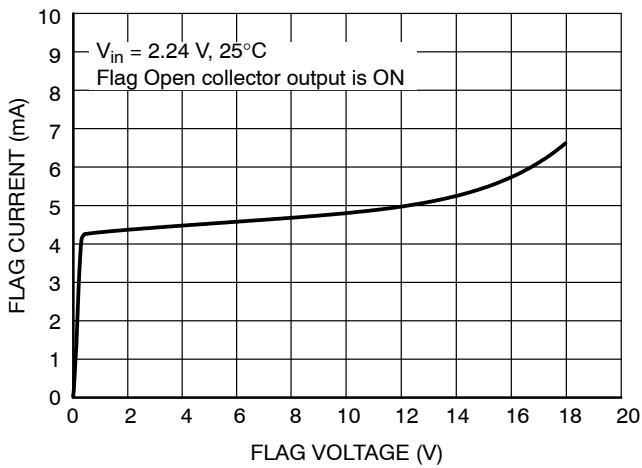

Figure 19. Flag Current vs. Flag Voltage

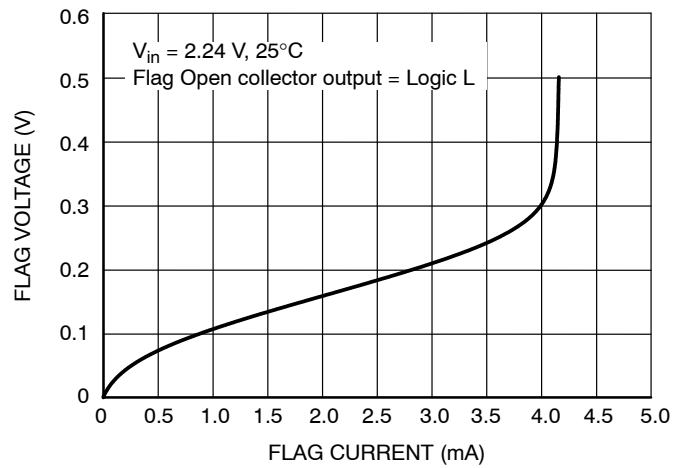

Figure 20. Flag Voltage vs. Flag Current

NCP59150, NCV59150 Series

TYPICAL CHARACTERISTICS

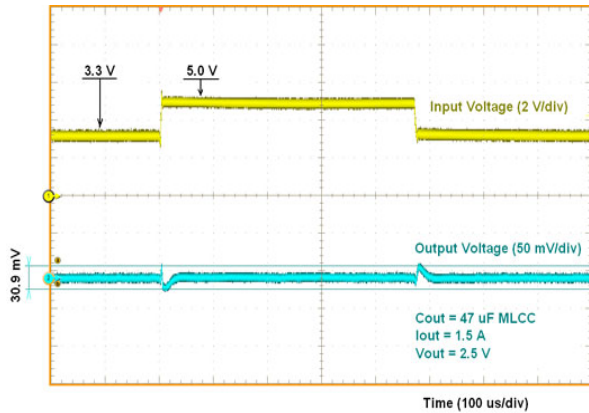

Figure 21. Line Transient Response

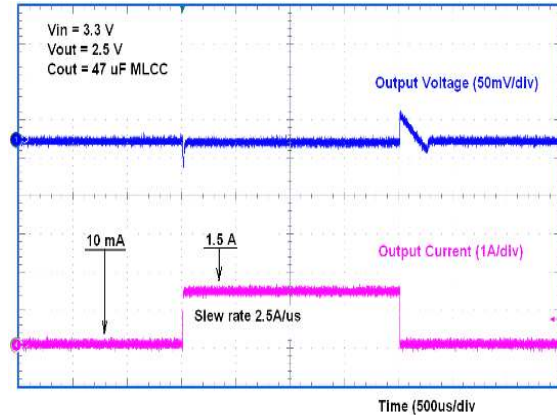

Figure 22. Load Transient Response

APPLICATIONS INFORMATION

Output Capacitor and Stability

The NCP59150 series requires an output capacitor for stable operation. The NCP59150 series is designed to operate with ceramic output capacitors. The recommended output capacitance value is 47 μF or greater. Such capacitors help to improve transient response and noise reduction at high frequency.

Input Capacitor

An input capacitor of 1.0 μF or greater is recommended when the device is more than 4 inches away from the bulk supply capacitance, or when the supply is a battery. Small, surface-mount chip capacitors can be used for the bypassing. The capacitor should be placed within 1 inch of the device for optimal performance. Larger values will help to improve ripple rejection by bypassing the input of the regulator, further improving the integrity of the output voltage.

Minimum Load Current

The NCP59150 regulator is specified between finite loads. A 5 mA minimum load current is necessary for proper operation.

Error Flag

Some NCP59150 series members feature an error flag circuit that monitors the output voltage and signals an error condition when the voltage is 5% below the nominal output voltage. The error flag is an open-collector output that can sink up to 5 mA typically during a V_{OUT} fault condition.

The FLG output is overload protected when a short circuit of the pullup load resistor occurs in the application. This is guaranteed in the full range of FLG output voltage Max ratings (see Max Ratings table). Please be aware operation in this mode is not recommended, power dissipated in the device can impact on output voltage precision and other device characteristics.

Enable Input

Some NCP59150 series members also feature an enable input for on/off control of the device. Its shutdown state draws “zero” current from input voltage supply (only microamperes of leakage). The enable input is TTL/CMOS compatible for simple logic interface, but can be connected up to V_{IN} .

Overcurrent and Reverse Output Current Protection

The NCP59150 regulator is fully protected from damage due to output current overload and output short conditions. When NCP59150 output is overloaded, Output Current limiting is provided. This limiting is linear; output current during overload or output short conditions is constant. These features are advantageous for powering FPGAs and other ICs having current consumption higher than nominal during their startup.

Thermal shutdown disables the NCP59150 device when the die temperature exceeds the maximum safe operating temperature.

When NCP59150 is disabled and $(V_{\text{OUT}} - V_{\text{IN}})$ voltage difference is less than 6.5 V in the application, the output structure of these regulators is able to withstand output voltage (backup battery as example) to be applied without reverse current flow. Of course the additional current flowing through the feedback resistor divider inside the Fixed Voltage devices (30 μA typically at nominal output voltage) needs to be included in the backup battery discharging calculations.

Adjustable Voltage Design

The NCP/NCV59152 Adjustable voltage Device Output voltage is set by the ratio of two external resistors as shown in Figure 23.

The device maintains the voltage at the ADJ pin at 1.24 V referenced to ground. The current in R2 is then equal to

NCP59150, NCV59150 Series

1.24 V / R2, and the current in R1 is the current in R2 plus the ADJ pin bias current. The ADJ pin bias current flows from V_{OUT} through R1 into the ADJ pin.

The output voltage can be calculated using the formula shown in Figure 23.

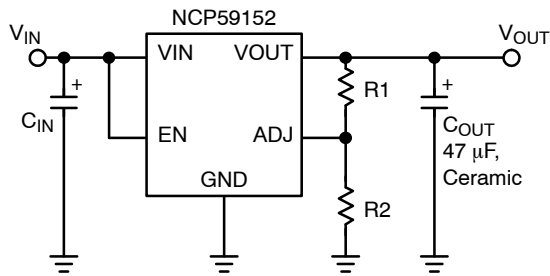

$$V_{OUT} = 1.24 \text{ V} \cdot \left(1 + \frac{R1}{R2} \right) + I_{ADJ} \cdot R1$$

Figure 23. Adjustable Voltage Operation

Thermal Considerations

The power handling capability of the device is limited by the maximum rated junction temperature (125°C). The P_D total power dissipated by the device has two components, Input to output voltage differential multiplied by Output current and Input voltage multiplied by GND pin current.

$$P_D = (V_{IN} - V_{OUT}) \cdot I_{OUT} + V_{IN} \cdot I_{GND} \quad (\text{eq. 1})$$

The GND pin current value can be found in Electrical Characteristics table and in Typical Characteristics graphs.

The Junction temperature T_J is

$$T_J = T_A + P_D \cdot R_{\theta JA} \quad (\text{eq. 2})$$

where T_A is ambient temperature and R_{θJA} is the Junction to Ambient Thermal Resistance of the NCP/NCV59150 device mounted on the specific PCB.

To maximize efficiency of the application and minimize thermal power dissipation of the device it is convenient to use the Input to output voltage differential as low as possible.

The static typical dropout characteristics for various output voltage and output current can be found in the Typical Characteristics graphs.

ORDERING INFORMATION

Device	Output Current	Output Voltage	Junction Temp. Range	Package	Shipping [†]
NCP59150DS18R4G	1.5 A	1.8 V	-40°C to +125°C	D ² PAK-3 (Pb-Free)	Contact Sales Office
NCP59150DS25R4G	1.5 A	2.5 V	-40°C to +125°C	D ² PAK-3 (Pb-Free)	Contact Sales Office
NCP59150DS28R4G	1.5 A	2.8 V	-40°C to +125°C	D ² PAK-3 (Pb-Free)	Contact Sales Office
NCP59150DS30R4G	1.5 A	3.0 V	-40°C to +125°C	D ² PAK-3 (Pb-Free)	Contact Sales Office
NCP59150DS33R4G	1.5 A	3.3 V	-40°C to +125°C	D ² PAK-3 (Pb-Free)	Contact Sales Office
NCP59150DS50R4G	1.5 A	5.0 V	-40°C to +125°C	D ² PAK-3 (Pb-Free)	Contact Sales Office
NCV59150DS18R4G*	1.5 A	1.8 V	-40°C to +125°C	D ² PAK-3 (Pb-Free)	Contact Sales Office
NCV59150DS25R4G*	1.5 A	2.5 V	-40°C to +125°C	D ² PAK-3 (Pb-Free)	Contact Sales Office
NCV59150DS28R4G*	1.5 A	2.8 V	-40°C to +125°C	D ² PAK-3 (Pb-Free)	Contact Sales Office
NCV59150DS30R4G*	1.5 A	3.0 V	-40°C to +125°C	D ² PAK-3 (Pb-Free)	Contact Sales Office
NCV59150DS33R4G*	1.5 A	3.3 V	-40°C to +125°C	D ² PAK-3 (Pb-Free)	Contact Sales Office
NCV59150DS50R4G*	1.5 A	5.0 V	-40°C to +125°C	D ² PAK-3 (Pb-Free)	Contact Sales Office
NCP59151DS18R4G	1.5 A	1.8 V	-40°C to +125°C	D ² PAK-5 (Pb-Free)	800 / Tape & Reel

[†]For information on tape and reel specifications, including part orientation and tape sizes, please refer to our Tape and Reel Packaging Specifications Brochure, BRD8011/D.

*NCV Prefix for Automotive and Other Applications Requiring Unique Site and Control Change Requirements; AEC-Q100 Qualified and PPAP Capable

NCP59150, NCV59150 Series

ORDERING INFORMATION (continued)

Device	Output Current	Output Voltage	Junction Temp. Range	Package	Shipping [†]
NCP59151DS25R4G	1.5 A	2.5 V	-40°C to +125°C	D ² PAK-5 (Pb-Free)	800 / Tape & Reel
NCP59151DS28R4G	1.5 A	2.8 V	-40°C to +125°C	D ² PAK-5 (Pb-Free)	800 / Tape & Reel
NCP59151DS30R4G	1.5 A	3.0 V	-40°C to +125°C	D ² PAK-5 (Pb-Free)	800 / Tape & Reel
NCP59151DS33R4G	1.5 A	3.3 V	-40°C to +125°C	D ² PAK-5 (Pb-Free)	800 / Tape & Reel
NCP59151DS50R4G	1.5 A	5.0 V	-40°C to +125°C	D ² PAK-5 (Pb-Free)	800 / Tape & Reel
NCV59151DS18R4G*	1.5 A	1.8 V	-40°C to +125°C	D ² PAK-5 (Pb-Free)	800 / Tape & Reel
NCV59151DS25R4G*	1.5 A	2.5 V	-40°C to +125°C	D ² PAK-5 (Pb-Free)	800 / Tape & Reel
NCV59151DS28R4G*	1.5 A	2.8 V	-40°C to +125°C	D ² PAK-5 (Pb-Free)	800 / Tape & Reel
NCV59151DS30R4G*	1.5 A	3.0 V	-40°C to +125°C	D ² PAK-5 (Pb-Free)	800 / Tape & Reel
NCV59151DS33R4G	1.5 A	3.3 V	-40°C to +125°C	D ² PAK-5 (Pb-Free)	800 / Tape & Reel
NCV59151DS50R4G	1.5 A	5.0 V	-40°C to +125°C	D ² PAK-5 (Pb-Free)	800 / Tape & Reel
NCP59151MN18TYG	1.5 A	1.8 V	-40°C to +125°C	DFN8-4x4 (Pb-Free)	4000 / Tape & Reel
NCP59151MN25TYG	1.5 A	2.5 V	-40°C to +125°C	DFN8-4x4 (Pb-Free)	4000 / Tape & Reel
NCP59151MN28TYG	1.5 A	2.8 V	-40°C to +125°C	DFN8-4x4 (Pb-Free)	4000 / Tape & Reel
NCP59151MN30TYG	1.5 A	3.0 V	-40°C to +125°C	DFN8-4x4 (Pb-Free)	4000 / Tape & Reel
NCP59151MN33TYG	1.5 A	3.3 V	-40°C to +125°C	DFN8-4x4 (Pb-Free)	4000 / Tape & Reel
NCP59151MN50TYG	1.5 A	5.0 V	-40°C to +125°C	DFN8-4x4 (Pb-Free)	4000 / Tape & Reel
NCV59151MN18TYG	1.5 A	1.8 V	-40°C to +125°C	DFN8-4x4 (Pb-Free)	4000 / Tape & Reel
NCV59151MN25TYG	1.5 A	2.5 V	-40°C to +125°C	DFN8-4x4 (Pb-Free)	4000 / Tape & Reel
NCV59151MN28TYG	1.5 A	2.8 V	-40°C to +125°C	DFN8-4x4 (Pb-Free)	4000 / Tape & Reel
NCV59151MN30TYG	1.5 A	3.0 V	-40°C to +125°C	DFN8-4x4 (Pb-Free)	4000 / Tape & Reel
NCV59151MN33TYG	1.5 A	3.3 V	-40°C to +125°C	DFN8-4x4 (Pb-Free)	4000 / Tape & Reel
NCV59151MN50TYG	1.5 A	5.0 V	-40°C to +125°C	DFN8-4x4 (Pb-Free)	4000 / Tape & Reel
NCP59152MNADJTYG	1.5 A	ADJ	-40°C to +125°C	DFN8-4x4 (Pb-Free)	4000 / Tape & Reel
NCV59152MNADJTYG	1.5 A	ADJ	-40°C to +125°C	DFN8-4x4 (Pb-Free)	4000 / Tape & Reel

[†]For information on tape and reel specifications, including part orientation and tape sizes, please refer to our Tape and Reel Packaging Specifications Brochure, BRD8011/D.

*NCV Prefix for Automotive and Other Applications Requiring Unique Site and Control Change Requirements; AEC-Q100 Qualified and PPAP Capable

NCP59150, NCV59150 Series

ORDERING INFORMATION (continued)

Device	Output Current	Output Voltage	Junction Temp. Range	Package	Shipping [†]
NCP59152DSADJR4G	1.5 A	ADJ	-40°C to +125°C	D2PAK-5 (Pb-Free)	800 / Tape & Reel
NCV59152DSADJR4G	1.5 A	ADJ	-40°C to +125°C	D2PAK-5 (Pb-Free)	800 / Tape & Reel

[†]For information on tape and reel specifications, including part orientation and tape sizes, please refer to our Tape and Reel Packaging Specifications Brochure, BRD8011/D.

*NCV Prefix for Automotive and Other Applications Requiring Unique Site and Control Change Requirements; AEC-Q100 Qualified and PPAP Capable

NCP59150, NCV59150 Series

PACKAGE DIMENSIONS

D²PAK 5-LEAD CASE 936A-02 ISSUE E

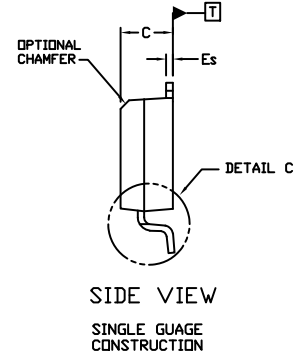
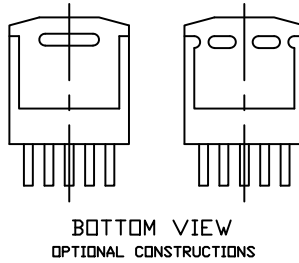
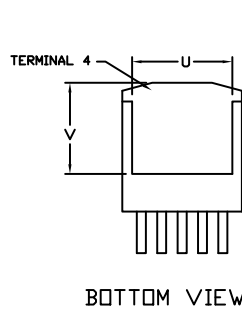
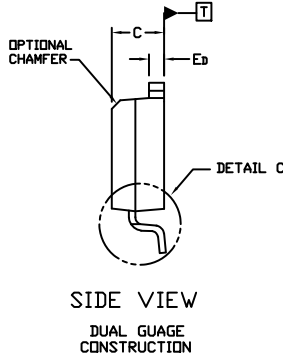
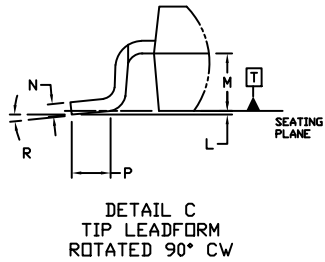
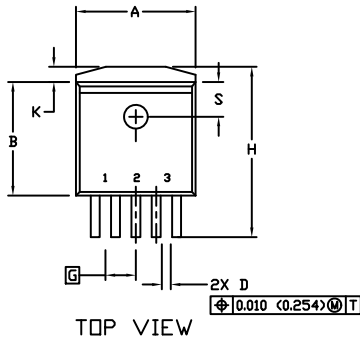

NOTES:

1. DIMENSIONING AND TOLERANCING PER ANSI Y14.5M, 1982.
2. CONTROLLING DIMENSION: INCHES
3. TAB CONTOUR OPTIONAL WITHIN DIMENSIONS A AND K.
4. DIMENSIONS U AND V ESTABLISH A MINIMUM MOUNTING SURFACE FOR TERMINAL 4.
5. DIMENSIONS A AND B DO NOT INCLUDE MOLD FLASH OR GATE PROTRUSIONS. MOLD FLASH AND GATE PROTRUSIONS NOT TO EXCEED 0.025 (0.635) MAXIMUM.

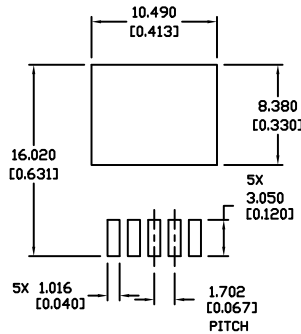

* For additional information on our Pb-Free strategy and soldering details, please download the IN Semiconductor Soldering and Mounting Techniques Reference Manual, SOLDERRM/D.

DIM	INCHES		MILLIMETERS	
	MIN.	MAX.	MIN.	MAX.
A	0.396	0.403	9.804	10.236
B	0.356	0.368	9.042	9.347
C	0.170	0.180	4.318	4.572
D	0.026	0.036	0.660	0.914
Ed	0.045	0.055	1.143	1.397
Es	0.018	0.026	0.457	0.660
G	0.067 BSC		1.702 BSC	
H	0.539	0.579	13.691	14.707
K	0.050 REF		1.270 REF	
L	0.000	0.010	0.000	0.254
M	0.088	0.102	2.235	2.591
N	0.018	0.026	0.457	0.660
P	0.058	0.078	1.473	1.981
R	0°		8°	
S	0.116 REF		2.946 REF	
U	0.200 MIN		5.080 MIN	
V	0.250 MIN		6.350 MIN	

NCP59150, NCV59150 Series

PACKAGE DIMENSIONS

D²PAK
CASE 936-03
ISSUE E

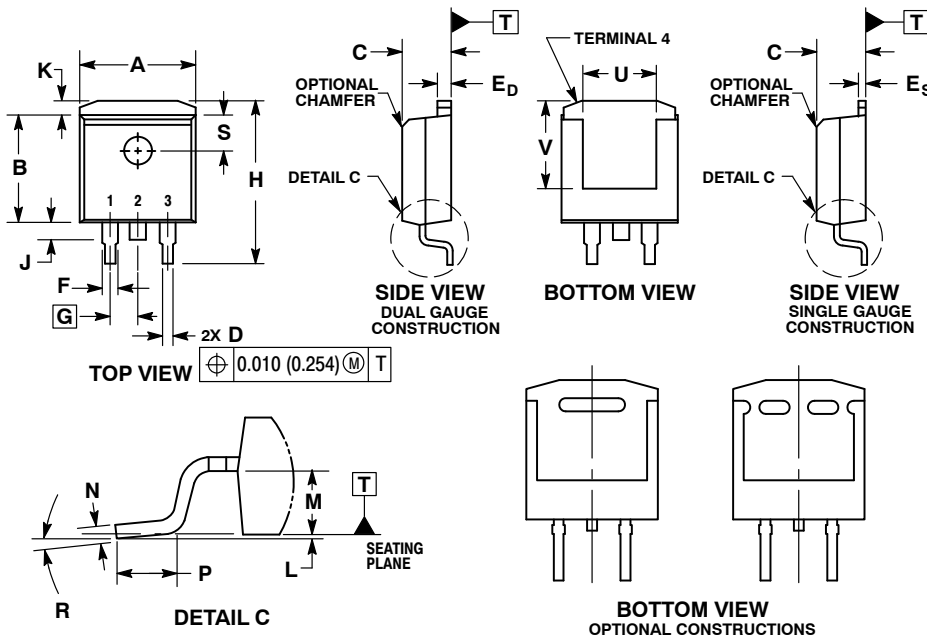

NOTES:

1. DIMENSIONING AND TOLERANCING PER ANSI Y14.5M, 1982.
2. CONTROLLING DIMENSION: INCHES.
3. TAB CONTOUR OPTIONAL WITHIN DIMENSIONS A AND K.
4. DIMENSIONS U AND V ESTABLISH A MINIMUM MOUNTING SURFACE FOR TERMINAL 4.
5. DIMENSIONS A AND B DO NOT INCLUDE MOLD FLASH OR GATE PROTRUSIONS. MOLD FLASH AND GATE PROTRUSIONS NOT TO EXCEED 0.025 (0.635) MAXIMUM.
6. SINGLE GAUGE DESIGN WILL BE SHIPPED AFTER FPCN EXPIRATION IN OCTOBER 2011.

DIM	INCHES		MILLIMETERS	
	MIN	MAX	MIN	MAX
A	0.386	0.403	9.804	10.236
B	0.356	0.368	9.042	9.347
C	0.170	0.180	4.318	4.572
D	0.026	0.036	0.660	0.914
E _D	0.045	0.055	1.143	1.397
E _S	0.018	0.026	0.457	0.660
F	0.051 REF		1.295 REF	
G	0.100 BSC		2.540 BSC	
H	0.539	0.579	13.691	14.707
J	0.125 MAX		3.175 MAX	
K	0.050 REF		1.270 REF	
L	0.000	0.010	0.000	0.254
M	0.088	0.102	2.235	2.591
N	0.018	0.026	0.457	0.660
P	0.058	0.078	1.473	1.981
R	0°	8°	0°	8°
S	0.116 REF		2.946 REF	
U	0.200 MIN		5.080 MIN	
V	0.250 MIN		6.350 MIN	

SOLDERING FOOTPRINT*

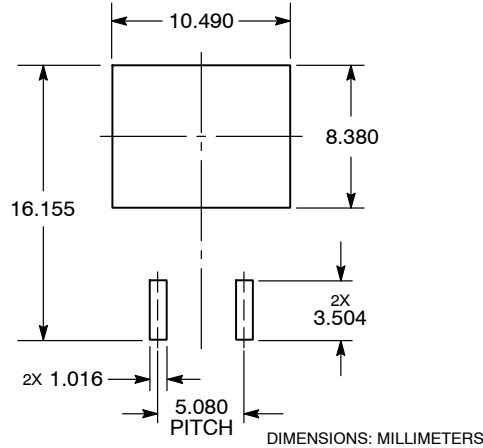

*For additional information on our Pb-Free strategy and soldering details, please download the **onsemi** Soldering and Mounting Techniques Reference Manual, SOLDERRM/D.

NCP59150, NCV59150 Series

PACKAGE DIMENSIONS

DFN8, 4x4
CASE 488AF
ISSUE C

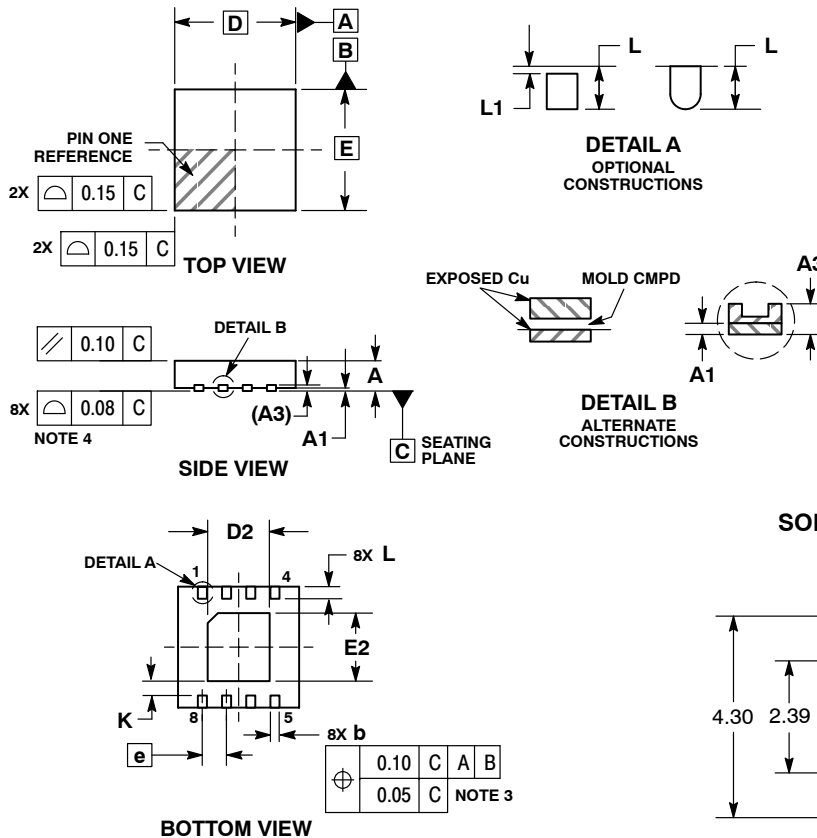

NOTES:

1. DIMENSIONS AND TOLERANCING PER ASME Y14.5M, 1994.
2. CONTROLLING DIMENSION: MILLIMETERS.
3. DIMENSION b APPLIES TO PLATED TERMINAL AND IS MEASURED BETWEEN 0.15 AND 0.30MM FROM TERMINAL TIP.
4. COPLANARITY APPLIES TO THE EXPOSED PAD AS WELL AS THE TERMINALS.
5. DETAILS A AND B SHOW OPTIONAL CONSTRUCTIONS FOR TERMINALS.

DIM	MILLIMETERS	
	MIN	MAX
A	0.80	1.00
A1	0.00	0.05
A3	0.20 REF	
b	0.25	0.35
D	4.00 BSC	
D2	1.91	2.21
E	4.00 BSC	
E2	2.09	2.39
e	0.80 BSC	
K	0.20	---
L	0.30	0.50
L1	---	0.15

SOLDERING FOOTPRINT*

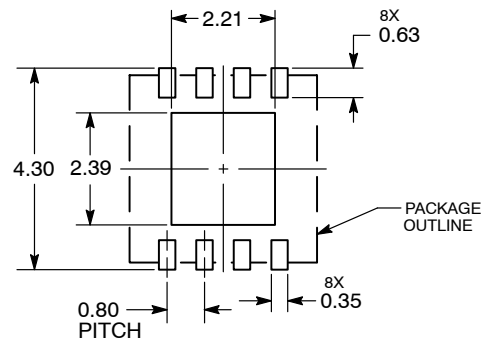

DIMENSIONS: MILLIMETERS

*For additional information on our Pb-Free strategy and soldering details, please download the **onsemi** Soldering and Mounting Techniques Reference Manual, SOLDERRM/D.

onsemi, Onsemi, and other names, marks, and brands are registered and/or common law trademarks of Semiconductor Components Industries, LLC dba "onsemi" or its affiliates and/or subsidiaries in the United States and/or other countries. onsemi owns the rights to a number of patents, trademarks, copyrights, trade secrets, and other intellectual property. A listing of onsemi's product/patent coverage may be accessed at www.onsemi.com/site/pdf/Patent-Marking.pdf. onsemi reserves the right to make changes at any time to any products or information herein, without notice. The information herein is provided "as-is" and onsemi makes no warranty, representation or guarantee regarding the accuracy of the information, product features, availability, functionality, or suitability of its products for any particular purpose, nor does onsemi assume any liability arising out of the application or use of any product or circuit, and specifically disclaims any and all liability, including without limitation special, consequential or incidental damages. Buyer is responsible for its products and applications using onsemi products, including compliance with all laws, regulations and safety requirements or standards, regardless of any support or applications information provided by onsemi. "Typical" parameters which may be provided in onsemi data sheets and/or specifications can and do vary in different applications and actual performance may vary over time. All operating parameters, including "Typicals" must be validated for each customer application by customer's technical experts. onsemi does not convey any license under any of its intellectual property rights nor the rights of others. onsemi products are not designed, intended, or authorized for use as a critical component in life support systems or any FDA Class 3 medical devices or medical devices with a same or similar classification in a foreign jurisdiction or any devices intended for implantation in the human body. Should Buyer purchase or use onsemi products for any such unintended or unauthorized application, Buyer shall indemnify and hold onsemi and its officers, employees, subsidiaries, affiliates, and distributors harmless against all claims, costs, damages, and expenses, and reasonable attorney fees arising out of, directly or indirectly, any claim of personal injury or death associated with such unintended or unauthorized use, even if such claim alleges that onsemi was negligent regarding the design or manufacture of the part. onsemi is an Equal Opportunity/Affirmative Action Employer. This literature is subject to all applicable copyright laws and is not for resale in any manner.

PUBLICATION ORDERING INFORMATION

LITERATURE FULFILLMENT:
Email Requests to: orderlit@onsemi.com

TECHNICAL SUPPORT
North American Technical Support:
Voice Mail: 1 800-282-9855 Toll Free USA/Canada
Phone: 011 421 33 790 2910

Europe, Middle East and Africa Technical Support:
Phone: 00421 33 790 2910
For additional information, please contact your local Sales Representative