



Productivity
Through
Protection™

Disconnect Switches

Table of Contents
Fusible Disconnect Switches..... Page 2
Non-Fusible Disconnect Switches..... Page 29
Enclosed Fusible Disconnect Switches..... Page 71
Enclosed Non-Fusible Disconnect Switches..... Page 75
Index by Part Number Page 86

Fusible
Non-Fused
Enclosed Fused
Enclosed Non-Fused



CFD30CC3 – FD800L3

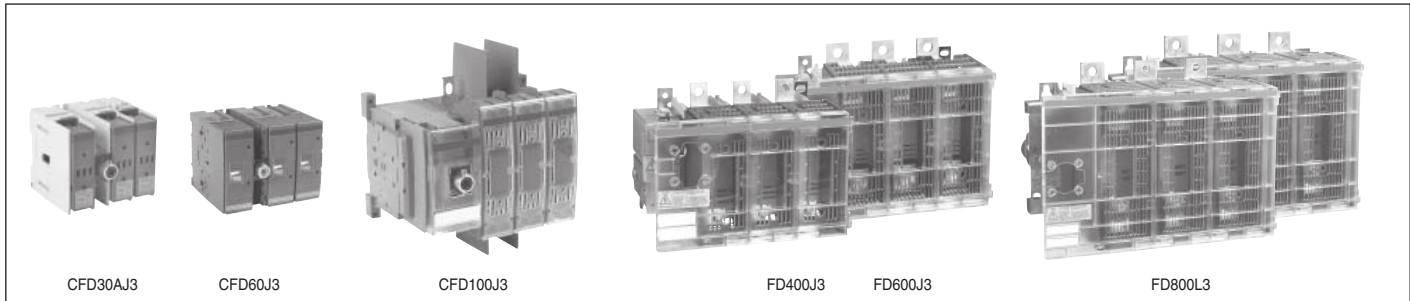

Fusible

Non-Fused

Enclosed Fused

Enclosed Non-Fused

Catalog number	3 pole	CFD30ACC3	CFD30AJ3	CFD60J3	CFD100J3	CFD200J03	FD400J3	FD600J3	FD800L3	
General purpose amp rating	A	30	30	60	100	200	400	600	800	
Approvals^①	2 pole 3 pole 4 pole	N/A UL98 & IEC UL98 & IEC	N/A UL98 & IEC UL98 & IEC	N/A UL98 & IEC UL98 & IEC	UL98 & IEC UL98 & IEC UL98 & IEC	UL98 & IEC UL98 & IEC UL98 & IEC	UL98 & IEC UL98 & IEC UL98 & IEC	UL98 & IEC UL98 & IEC UL98 & IEC	UL98 & IEC UL98 & IEC UL98 & IEC	
Technical ratings (UL, cULus)										
Max operating voltage	V	600	600	600	600	600	600	600	600	
Max horsepower rating										
Three phase										
200 – 208V	HP	5/7.5	5/7.5	15	25	50	100/125	150	200	
240V	HP	7.5	7.5	15	30	60	125	200	250	
480V	HP	15	15	30	60	125	250	400	500	
600V	HP	20	20	50	75	150	350	500	600	
Single phase										
120V	HP	2	2	—	—	—	—	—	—	
240V	HP	3	3	—	—	—	—	—	—	
UL fuse class		CC	J	J	J	J	J,T	J,T	L	
Technical ratings (IEC)										
Rated insulation and operational voltage. AC20 and DC20 ^②		1000	1000	750	750	1000	1000	1000	1000	
Rated thermal current, I _{th}										
AC 20/DC 20 open	A	32	32	63	125	200	400	630	800	
AC 20/DC 20 enclosed	A	32	32	63	125	200	400	600	720	
AC 21A 500V	A	32	32	63	125	200	400	630	800	
690V	A	32	32	63	125	200	400	630	800	
Rated operational power AC23										
400/415V	kW	14/15	14/15	30	80/90	110	210/230	315/340	350/380	
690V	kW	25	25	60	132	200	330	540	600	
Physical characteristics										
Weight	3 pole switch 4 pole	lb lb	1.54 1.98	1.54 1.98	2.86 3.52	3.30 3.96	5.9 7.5	17.2 19.4	37.48 46.3	37.48 46.3
Dimension	3 pole	H in W in D in	3.82 4.17 4.21	3.82 4.17 4.21	3.94 5.63 5.04	5.66 7.06 5.09	6.5 7.1 5.2	7.87 11.22 8.11	11.42 14.69 9.21	11.42 14.69 9.21
Accessories										
Double break contacts		S	S	S	S	S	S	S	S	
Fuse cover		S	S	S	•	S	S	S	S	
Terminal lug kit		Integral	Integral	Integral	BDTL24	CDTL200	BDTL26	BDTL27	BDTL27	
Terminal shroud		Not required	Not required	Not required	•	•	•	•	•	
Auxiliary contact		•	•	•	•	•	•	•	•	
Handle UL/NEMA type										
Type 1, 3R, 12		•	•	•	•	•	•	•	•	
Type 1, 3R, 4, 4X, 12		•	•	•	•	•	•	•	•	
Conversion kit										
6 pole		•	•	•	•	•	•	•	•	
Electrical interlock		—	—	—	—	•	•	•	•	

S = Standard
• = Available
— = Not available

UL Listed, cULus approved, IEC rated, CE marked

① UL Listed switches are also cULus approved.
② 1000V IEC 408

30A Fusible Disconnect Switches Base & DIN Rail Mounted



UL Fuse Class J, CC

For a complete assembly,
please select one of each:

- 1 switch
- 1 handle
- 1 shaft



CFD30AJ3



BDS__



CDH3S

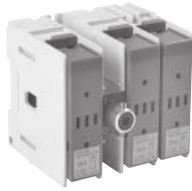

CFD30AJ3



CBDH3S, 5S



CBDH4S, 6S



BDS__

30 Amp switches, 600V

UL general purpose amp rating	UL Fuse type 600V	Maximum horsepower rating					Terminal lugs		Catalog number
		Three phase					Wire size	Wire type	
		200V	208V	240V	480V	600V			
3 pole									
30	J	5	7.5	7.5	15	20	#18-8	Cu	CFD30AJ3
30 [Ⓞ]	CC	5	7.5	7.5	15	20	#18-8	Cu	CFD30ACC3
4 pole									
30	J	5	7.5	7.5	15	20	#18-8	Cu	CFD30AJ4
30 [Ⓞ]	CC	5	7.5	7.5	15	20	#18-8	Cu	CFD30ACC4

Selector handles — for use with shafts .24 x .24" (6 x 6 mm)

NEMA type	IEC type	Color	Defeatable	Padlockable	Weight (lbs.)	Catalog number
-----------	----------	-------	------------	-------------	---------------	----------------

All marked both **O/I** & **Off/On**

1,3R,12	IP65	Black	—	Yes	0.16	CBDH3S
1,3R,12	IP65	Red/Yellow	—	Yes	0.16	CBDH4S
1,3R,12	IP65	Black	Yes	Yes	0.16	CBDH5S
1,3R,12	IP65	Red/Yellow	Yes	Yes	0.16	CBDH6S

Shafts — for use with CBDH selector handles .24 x .24" (6 x 6 mm)

Shaft length (inches/mm)	Mounting depth (in inches)	Weight (lbs.)	Catalog number
3.3/85	5.5 – 5.7	0.04	BDS85S
4.1/105	5.5 – 6.5	0.04	BDS105S
4.7/120	5.5 – 7.1	0.05	BDS120S
5.1/130	5.5 – 7.5	0.05	BDS130S
7.1/180	6.3 – 9.4	0.08	BDS180S
9.8/250	9.1 – 12.2	0.10	BDS250S
13.0/330	12.2 – 15.4	0.14	BDS330S

Ⓞ Rejection style fuses only.

For a complete assembly,
please select one of each:

- 1 switch
- 1 handle
- 1 shaft



CFD30AJ3



BDS_



BDH59

Pistol handles — for use with shafts .24 x .24" (6 x 6 mm)

NEMA type	IEC type	Color	Marking	Length inches/mm	Defeatable	Padlockable	Weight (lbs.)	Catalog number
1,3R,12	IP65	Black	O/I & Off/On	1.8/45	Yes	Yes	0.28	BDH56
1,3R,12	IP65	Red/Yellow	O/I & Off/On	1.8/45	Yes	Yes	0.28	BDH57
1,3R,12	IP65	Black	O/I & Off/On	2.6/65	Yes	Yes	0.29	BDH58
1,3R,12	IP65	Red/Yellow	O/I & Off/On	2.6/65	Yes	Yes	0.29	BDH59
1,3R,4,4X,12	IP65	Black	O/I & Off/On	2.6/65	Yes	Yes	0.29	CDHXB65L6
1,3R,4,4X,12	IP65	Red/Yellow	O/I & Off/On	2.6/65	Yes	Yes	0.29	CDHXY65L6
1,3R,12	IP65	Black	Off/On/Test	2.6/65	Yes	Yes	0.29	BDH58T
1,3R,12	IP65	Red/Yellow	Off/On/Test	2.6/65	Yes	Yes	0.29	BDH59T

Shafts — for use with pistol handles .24 x .24" (6 x 6 mm)

Shaft length (inches/mm)	Mounting depth (in inches)	Weight (lbs.)	Catalog number
5.9/150	4.9 – 8.9	0.07	BDS150
6.7/170	5.9 – 9.7	0.08	BDS170
10.4/265	9.5 – 13.4	0.12	BDS265
15.8/400	15.0 – 18.7	0.18	BDS400
19.7/500	20.5 – 22.6	0.23	BDS500

Direct mount handle — mounts directly to switch, no shaft necessary

NEMA type	Color	Marking	Length mm	Padlockable	Weight (lbs.)	Catalog number
1	Blk	O/I/Test	50	Yes	0.10	BDHA79



BDH56, BDH58



BDH57, BDH59



BDS_

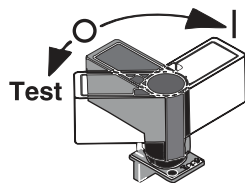

BDHA79

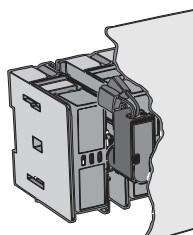

BDHA79 Mounted

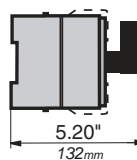

5.20"/132mm
BDHA79 Mounted depth

Fusible

Non-Fused

Enclosed Fused

Enclosed Non-Fused

Accessories for 30A Fusible Disconnect Switches

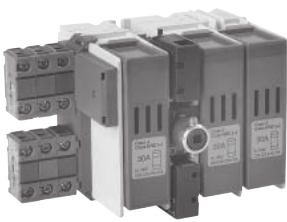

CFD30AJ3 with auxiliaries

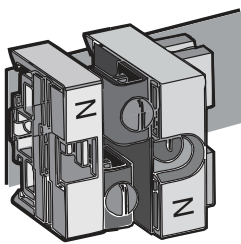

CFDZX171

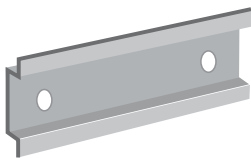

NDNA100

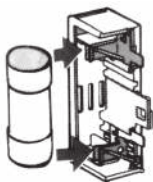

BDZD48



CXBY67121

Auxiliary contacts^①

Description	For use on:	Weight (lbs)	AC thermal amp rating	AC rated voltage	Catalog number
Form C 1 N.O. & 1 N.C. (2 maximum)	CFD30_ for direct mounting to switch	0.04	6	250	BDAUX157
1 N.O. 1 N.C. (6 maximum)	CFD30_ CDAUXB mounting base required	0.03	NEMA A600,P600		CDAUX10 CDAUX01K

Mounting base

Description	For use with:	Weight (lbs)	Catalog number
Mounting base	CDAUX10, CDAUX01K	0.08	CDAUXB

Terminal pole

Description	For use on:	Weight (lbs)	AC thermal amp rating	AC rated voltage	Catalog number
Detachable neutral mounts on side of switch or DIN rail	CFD30_	0.45	30	600	CFDZX171

DIN rail

Description	For use on:	Weight (lbs.)	Length inches/mm	Catalog number
35mm DIN Rail	CFD30_	.38	39.4/1000	NDNA100
35mm Aluminum DIN Rail	CFD30_	.75	78.8/2000	NDNA200

Fuse Carriers (Replacement Parts)

Description	For use on:	Catalog number
CC fuse carrier	BDCF30CC_	BDZD48
J fuse carrier	BDCF30J_	BDZD28
Class CC Solid link	CFD30_	NNB-R

Terminal cover (replacement part)

Description	For use on:	Catalog number
Covers terminal below fuse carrier	CFD30_	CDBY67121

^① UL File # E83510

Fusible

Non-Fused

Enclosed Fused

Enclosed Non-Fused

Fusible

Non-Fused

Enclosed Fused

Enclosed Non-Fused

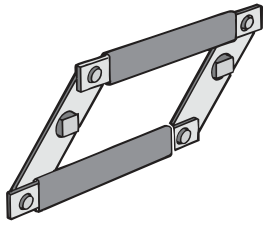

BDZW6

Conversion mechanisms

- Switches are not included

Description	For use on:	Weight (lbs)	Catalog number
6 pole	CFD30	1.74	BDZW6
8 pole	CFD30	1.90	BDZX8

6 or 8 pole — BDZW5

6 (8) pole mechanism allows two switches, controlled by one handle, to open or close simultaneously.

Equipment required for a complete installation:

- One conversion mechanism
- Two disconnect switches
- One handle
- One 5 mm shaft

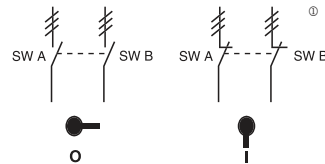

	POS. O	POS. I
SW. A	O	X
SW. B	O	X

X = Closed
 O = Open

Ⓢ = Three poles

60A – 100A for Fusible Disconnect Switches



UL Fuse Class J

For a complete assembly,
please select one of each:

- 1 switch
- 1 handle
- 1 shaft
- 1 terminal lug kit



CFD60J3



BDS210



BDH58

60 – 100 Amp switches, 600V

UL general purpose amp rating	UL Fuse type 600V	Maximum horsepower rating					Catalog number	
		Three phase						
		200V	208V	240V	480V	600V		
3 pole	60	J	15	15	15	30	50	3 pole CFD60J3 CFD100J3
	100	J	25	25	30	60	75	
4 pole	60	J	15	15	15	30	50	4 pole CFD60J4 CFD100J4
	100	J	25	25	30	60	75	

Pistol handles — .24 x .24" (6 x 6mm)

NEMA/UL type	IEC type	Color	Length in/mm	Marking	Defeatable	Padlockable	Weight (lbs.)	Catalog number
1,3R,12	IP65	Black	2.6/65	O/I & Off/On	Yes	Yes	0.29	BDH58
1,3R,12	IP65	Red/Yel	2.6/65	O/I & Off/On	Yes	Yes	0.29	BDH59
1,3R,12	IP65	Black	3.1/80	O/I & Off/On	Yes	Yes	0.30	BDH60
1,3R,12	IP65	Red/Yel	3.1/80	O/I & Off/On	Yes	Yes	0.30	BDH61
1,3R,4,4X,12	IP65	Black	3.1/80	O/I & Off/On	Yes	Yes	0.30	CDHXB86
1,3R,4,4X,12	IP65	Red/Yel	3.1/80	O/I & Off/On	Yes	Yes	0.30	CDHXY86

Shafts — .24 x .24" (6 x 6mm)

Shaft length (inches/mm)	Mounting depth (inches)	Weight (lbs.)	Catalog number
5.9/150	5.5 – 8.5	0.09	BDS150
8.3/210	8.0 – 11.0	0.13	BDS210
11.4/290	11.0 – 14.0	0.18	BDS290
14.2/360	13.8 – 16.8	0.23	BDS360
16.9/430	16.5 – 19.7	0.27	BDS430

Twisted shafts — Rotates handle 45° .24 x .24" (6 x 6mm)

Shaft length (inches/mm)	Mounting depth (inches)	Weight (lbs.)	Catalog number
5.1/130	4.8 – 7.8	0.08	BDST4
8.3/210	8.0 – 11.0	0.13	BDST25
11.4/290	11.0 – 14.0	0.18	BDST29
14.2/360	13.8 – 16.8	0.23	BDST30

Direct mount handle — mounts directly to switch, no shaft necessary

NEMA type	Color	Marking	Length mm	Padlockable	Weight (lbs.)	Catalog number
1	Black	O/I/Test	50	Yes	0.10	CDH4



CFD60J3

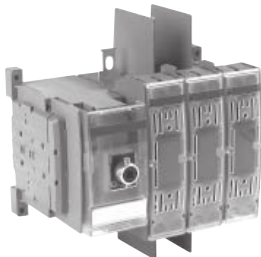

CFD100J3



BDH58,60



BDH59,61



BDS_



BDST_

Fusible

Non-Fused

Enclosed Fused

Enclosed Non-Fused

Fusible

Non-Fused

Enclosed Fused

Enclosed Non-Fused



BDTL24

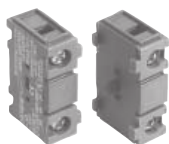

CDAUX10, CDAUX01K

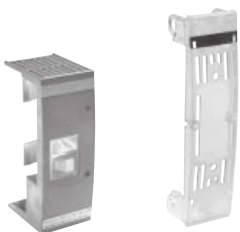

CFC60J

CFCVR100



CFTS100

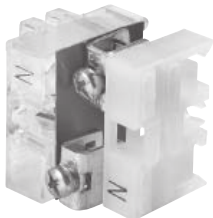

CFZ1

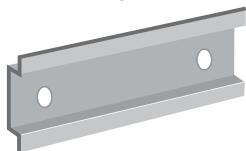

NDNA100

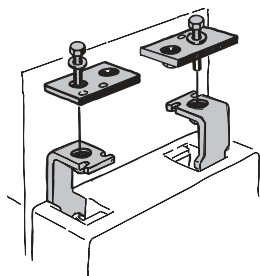

BDTA1

Terminal lug kit

For use on:	Wire size	Kit weight (lbs)	Wire type	Terminal lugs per kit	Catalog number
CFD60J_	#14 – 4	—	Cu	—	Integral
CFD100J_	#14 – 2/0	0.43	Cu/Al	6	BDTL24

Auxiliary contacts

Description	For use on:	Weight (lbs)	AC thermal amp rating	AC rated voltage	Catalog number
1 N.O. 1 N.C.	CFD60 – CFD100	0.07 0.07	10 10	600 600	CDAUX10 CDAUX01K

Replacement fuse clip

Description	For use on:	Catalog number
Removable fuse carrier	CFD60	CFC60J

Replacement fuse covers

Description	For use on:	Catalog number
Transparent fuse cover	CFD100	CFCVR100

Terminal shroud

Description	For use on:	Weight (lbs)	Catalog number
Includes one terminal shroud for line or load side	CFD100, 1-POLE	0.04	CFTS100

Terminal poles

Description	For use on:	Weight (lbs.)	AC thermal amp rating	AC rated voltage	Catalog number
Detachable neutral mounts on side of switch or DIN rail	CFD60	0.13	63	600	CFZ1
	CFD100	0.31	125	600	CFZ2

DIN rail

Description	For use on:	Weight (lbs.)	Length inches/mm	Catalog number
35mm Aluminum DIN Rail	CFD60	.38	39.4/1000	NDNA100
35mm Aluminum DIN Rail	CFD60	.75	78.8/1000	NDNA200

“T” type fuse adapter kit

Description	For use on:	Catalog number
100A, 600V	CFD100	BDTA1

Accessories for 60A – 100A Fusible Disconnect Switches

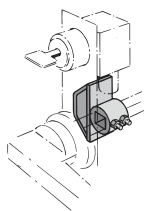

CDETL-ZW16

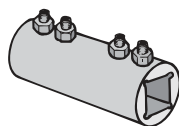

BDZX167
BDZW95

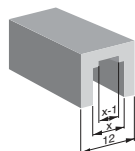

CDZK19
(X=6MM)

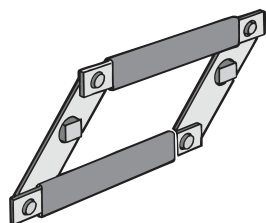

BDZW2

Locking accessories

Description	For use on:	Weight (lbs)	Catalog number
Cam attachment for Kirk Key, Castell, Lowe & Fletcher and Ronis interlock. Cam attachment for adapting to the interlock system. The interlock is not included.	CFD60 – CFD100	0.25	CDETL-ZW16

Shaft extension coupler

Description	For use on:	Weight (lbs)	Catalog number
Joins two shafts together for applications where extended length is required	6mm shafts	0.26	BDZX167 BDZW95
	12mm shafts	0.26	

Shaft adapter

Description	For use on:	Weight (lbs)	Catalog number
Adapts one end of a 6mm shaft to 12mm. Use with shaft extension coupler	6mm shafts	0.20	CDZK19

Conversion mechanisms

- Switches are not included

Description	For use on:	Weight (lbs)	Catalog number
6 and 8 pole	CFD60 – CFD100	1.52	BDZW2
Mechanical interlock	CFD60 – CFD100	0.55	BDZW10

6 or 8 pole — BDZW2

6 (8) pole mechanism allows two switches controlled by one handle, to open or close simultaneously. Shafts included.

Equipment required for a complete installation:

- One conversion mechanism
- Two disconnect switches
- One handle

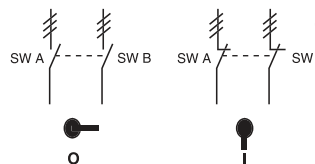

	POS. O	POS. I
SW. A	O	X
SW. B	O	X

X = Closed
O = Open

① = Three poles

Fusible

Non-Fused

Enclosed Fused

Enclosed Non-Fused

UL Fuse Class J

For a complete assembly, please select one of each:

- 1 switch
- 1 handle
- 1 shaft
- 1 terminal lug kit

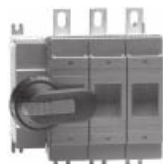

CFD200J03



BDS210



BDH58



CDTL200

200 Amp Switches, 600V

UL general purpose amp rating	UL fuse type 600V	Maximum horsepower rating					Catalog number
		Three phase					
		200V	208V	240V	480V	600V	
3 pole							
200	J	50	50	60	125	150	CFD200J03
4 pole							
200	J	50	50	60	125	150	CFD200J04

Pistol handles - □ .24 x .24" (□ 6 x 6mm)

UL/NEMA type	IEC type	Color	Length inches/mm	Marking	Defeatable	Padlockable	Weight (lbs)	Catalog number
1,3R,12	IP65	Black	2.6/65	O/I & Off/On	Yes	Yes	0.29	BDH58
1,3R,12	IP65	Red/Yel	2.6/65	O/I & Off/On	Yes	Yes	0.29	BDH59
1,3R,12	IP65	Black	3.1/80	O/I & Off/On	Yes	Yes	0.30	BDH60
1,3R,12	IP65	Red/Yel	3.1/80	O/I & Off/On	Yes	Yes	0.30	BDH61
1,3R,4,4X,1	IP65	Black	3.1/80	O/I & Off/On	Yes	Yes	0.30	CDHXB86
1,3R,4,4X,12	IP65	Red/Yel	3.1/80	O/I & Off/On	Yes	Yes	0.30	CDHXY86

Shafts - □ .24 x .24" (□ 6 x 6mm)

Shaft length (inches/mm)	Mounting dept (inches)	Weight (lbs)	Catalog number
5.9/150	5.5-8.5	0.09	BDS150
8.3/210	8.0-11.0	0.13	BDS210
11.4/290	11.0-14.0	0.18	BDS290
14.2/360	13.8-16.8	0.23	BDS360
16.9/430	16.5-19.7	0.27	BDS430

Twisted shafts - rotates handle 45° □ .24 x .24" (□ 6 x 6mm)

Shaft length (inches/mm)	Mounting dept (inches)	Weight (lbs)	Catalog number
5.1/130	4.8-7.8	0.08	BDST4
8.3/210	8.0-11.0	0.13	BDST25
11.4/290	11.0-14.0	0.18	BDST29
14.2/360	13.8-16.8	0.23	BDST30

Direct mount handle - mounts directly to switch, no shaft necessary

Nema Type	Color	Marking	Padlockable	(lbs)	Catalog number
1	Black	O/I	Yes	0.1	CDHSB20
1	Red/Yel	O/I	Yes	0.3	CDHSY20

Fusible

Non-Fused

Enclosed Fused

Enclosed Non-Fused



BDH58,60



BDH58,61



BDS_

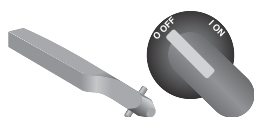

BDST_

Accessories for 200A Fusible Disconnect Switches

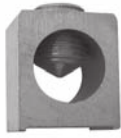

CDTL200

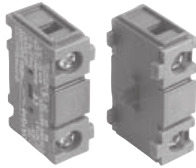

CDAUX10, CDAUX01K



CDSS200S3



CDSS200L3

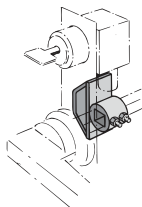

CDETL-ZW16

Terminal Lug Kits

For use on:	Wire Size	Wire Type	Description	Terminal lugs per kit	Weight (lbs)	Catalog number
CFD200J03	#4-300kcmil		---	6	0.5	CDTL200
CFD200J04	#4-300kcmil		---	3	0.25	CDTL200/3P
	(6) 14-6 AWG	Cu/Al	Distribution lug	3		CDTL206

Auxiliary Contacts

Description	For use on:	Weight (lbs)	Catalog number
1 N.O. 1 N.C.	CFD200J03, CFD200J04	0.07 0.07	CDAUX10 CDAUX01K

Module for auxiliary contacts

Description	Weight (lbs)	Catalog number
Screw mounting to the left side of the switch	0.1	CDAUXM28

Mounting on the left side of the switch: Max. 8 auxiliary contact blocks with the CDAUXM28
Mounting under the mechanism cover: Max. 4 auxiliary contact blocks

Replacement parts

Description	For use on:	Catalog number
Fuse cover Phase barrier	CFD200J03 and CFD200J04	CFCVR200 CPBR200

Terminal

For use on:	Description	Number of poles	Weight (lbs)	Catalog number
CFD200J03 and CFD200J04	Long type	3	0.2	CDSS200L3
	Short type	3	0.13	CDSS200S3
	Long type	4	0.26	CDSS200L4
	Short type	4	0.18	CDSS200S4

Terminal poles

Description	Weight (lbs)	AC thermal amp rating	AC rated voltage	Catalog number
Detachable neutral mounts on side of switch or DIN	0.88	200	600	CDD200P

Locking accessories

Description	Weight (lbs)	Catalog number
Cam attachment for Kirk Key, Castell, Lowe & Fletcher and Ronis interlock. Cam attachment for adapting to the interlock system. The interlock is not included.	0.25	CDETL-ZW16

Fusible

Non-Fused

Enclosed Fused

Enclosed Non-Fused

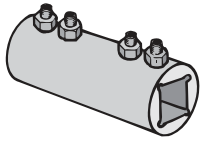

BDZX167, BDZW95

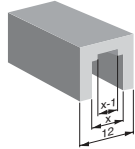

CDZK19
(X=6mm)



BDZW2

Shaft extension coupler

Description	For use on:	Weight (lbs)	Catalog number
Joins two shafts together for applications where extended length is required	6mm shafts 12mm shafts	0.26	BDZX167 BDZX95

Shaft adapter

Description	For use on:	Catalog number
Adapts one end of a 6mm shaft to 12mm. Use with shaft extension coupler.	6mm shafts	CDZK19

Conversion mechanisms

Description	Weight (lbs)	UL/NEMA type	Catalog number
6 and 8 pole	1.52	-----	BDZW2

Fusible

Non-Fused

Enclosed Fused

Enclosed Non-Fused

UL Fuse Class J, T, L

For a complete assembly, please select one of each:

- 1 switch
- 1 handle
- 1 shaft
- 1 terminal lug kit

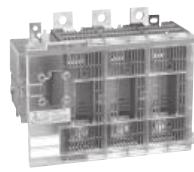

FD400J3



BDS280



BDH114



BDTL26

400 – 800 Amp switches, 600V

UL general purpose amp rating	UL Fuse type 600V	Maximum horsepower rating					Catalog number
		Three phase					
		200V	208V	240V	480V	600V	
2 pole							2 pole
400	J [Ⓟ]	—	—	—	—	—	FD400J2
600	J [Ⓟ]	—	—	—	—	—	FD600J2
800	L	—	—	—	—	—	FD800L2
3 pole							3 pole
400	J [Ⓟ]	100	125	125	250	350	FD400J3
600	J [Ⓟ]	150	150	200	400	500	FD600J3
800	L	200	200	250	500	600	FD800L3
4 pole							4 pole
400	J [Ⓟ]	100	125	125	250	350	FD400J4
600	J [Ⓟ]	150	150	200	400	500	FD600J4
800	L	200	200	250	500	600	FD800L4

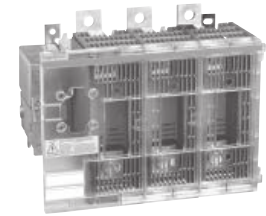

FD400J3

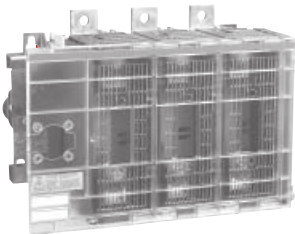

FD600J3
FD800L3



BDH112



BDH113

Pistol handles — □ .47 x .47" (□ 12 x 12mm)

NEMA type	IEC type	Color	Length inches/mm	Marking	Defeatable	Padlockable	Weight (lbs)	Catalog number
1,3R,12	IP65	Black	4.9/125	O/I & Off/On	Yes	Yes	0.39	BDH112
1,3R,12	IP65	Red/Yel	4.9/125	O/I & Off/On	Yes	Yes	0.39	BDH113
1,3R,12	IP65	Black	5.7/145	O/I & Off/On	Yes	Yes	0.39	BDH114
1,3R,12	IP65	Red/Yel	5.7/145	O/I & Off/On	Yes	Yes	0.39	BDH115
1,3R,12	IP65	Black	6.9/175	O/I & Off/On	Yes	Yes	0.41	BDH116
1,3R,12	IP65	Red/Yel	6.9/175	O/I & Off/On	Yes	Yes	0.41	BDH117
1,3R,4,4X,12	IP65	Black	5.7/145	O/I & Off/On	Yes	Yes	0.39	CDHXB12
1,3R,4,4X,12	IP65	Red/Yel	5.7/145	O/I & Off/On	Yes	Yes	0.39	CDHXY12
1,3R,4,4X,12	IP65	Black	6.9/175	O/I & Off/On	Yes	Yes	0.41	CDHXB22
1,3R,4,4X,12	IP65	Red/Yel	6.9/175	O/I & Off/On	Yes	Yes	0.41	CDHXY22
1,3R,4,4X,12	IP65	Metal	8.7/220	Off/On	—	Yes	1.50	BDH8

Ⓟ J type fuse clips are standard. If 600V Type "T" fuse clips are desired, please order a "T" type fuse adapter kit.

Fusible

Non-Fused

Enclosed Fused

Enclosed Non-Fused

Fusible

Non-Fused

Enclosed Fused

Enclosed Non-Fused



Shafts — □ .47 x .47" (□ 12 x 12mm)

Shaft length	 Mounting depth [Ⓢ] in inches	Weight	Catalog
For use on FD400J_			
8.7/220	7.9 – 12.2	0.61	BDS220
9.8/250	9.1 – 13.4	0.70	BDS250
11.0/280	10.2 – 14.5	0.77	BDS280
12.8/325	12.0 – 16.3	0.90	BDS325
15.6/395	14.8 – 19.1	1.10	BDS395
18.3/465	17.5 – 21.9	1.32	BDS465
21.1/535	20.3 – 24.6	1.54	BDS535
For use on FD600J_ – FD800J_			
9.8/250	10.0 – 12.8	0.70	BDS250
11.0/280	11.2 – 14.0	0.77	BDS280
12.8/325	13.0 – 15.8	0.90	BDS325
15.6/395	15.8 – 18.6	1.10	BDS395
18.3/465	18.5 – 21.3	1.32	BDS465
21.1/535	21.1 – 24.1	1.54	BDS535

Twisted shafts — Rotates handle 45° □ .47 x .47" (□ 12 x 12mm)

Shaft length (inches/mm)	 Mounting depth (inches)	Weight (lbs.)	Catalog number
For use on FD400J_			
11.0/280	10.2 – 14.5	0.77	BDS28045
12.8/325	12.0 – 16.3	0.90	BDS32545
18.3/465	17.5 – 21.9	1.32	BDS46545
For use on FD600J_ – FD800J_			
11.0/280	11.2 – 14.0	0.77	BDS28045
12.8/325	13.0 – 15.8	0.90	BDS32545
18.3/465	18.5 – 21.3	1.32	BDS46545

Terminal lug kit

For use on:	Wire size	Kit weight (lbs)	Wire type	Terminal lugs per kit	Catalog number
FD400J_	#2 – 600 kcmil	3.50	Cu/Al	6	BDTL26
FD600J – FD800L	(12)#14-16 – 600 kcmil	1.10	Cu/Al	3	BDTL175/400
FD600J_ & FD800L_	(2)#2 – 600 kcmil	4.62	Cu/Al	6	BDTL27

“T” type fuse adapter kit

For use on:	AC thermal amp rating	AC rated voltage	Poles	Catalog number
FD400J_	400	600	3	BDA4
FD600J_	600	600	3	BDA6

[Ⓢ] Mounting depth is the distance from the outside of the door to the disconnect switch mounting plate. Shaft can be cut to desired length.

Accessories for 400A – 800A Fusible Disconnect Switches

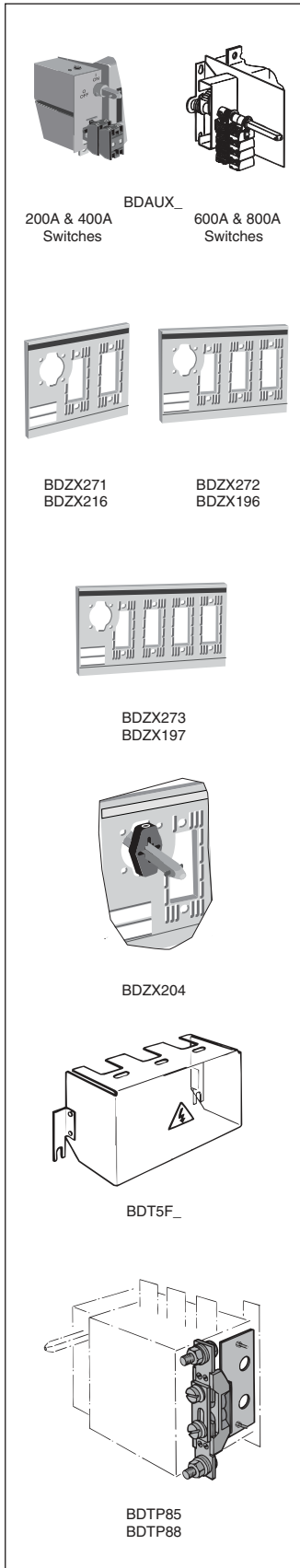

Auxiliary contacts[®]

Description	For use on:	Weight (lbs)	AC thermal amp rating	AC rated voltage	Catalog number
1 N.O. + 1 N.C.	FD400 – FD800	0.20	10	600	BDAUX1
2 N.O. + 2 N.C.		0.26	10	600	BDAUX2
4 N.O. + 4 N.C.		0.40	10	600	BDAUX3
2 N.O.		0.18	10	600	BDAUX4
4 N.O.		0.25	10	600	BDAUX5
8 N.O.		0.40	10	600	BDAUX6

Fuse covers (replacement part)

Description	For use on:	Weight (lbs)	Catalog number
2 pole	FD400	0.30	BDZX271
3 pole		0.40	BDZX272
4 pole		0.53	BDZX273
2 pole	FD600 – FD800	0.40	BDZX216
3 pole		0.50	BDZX196
4 pole		0.67	BDZX197

Fuse cover interlock

Description	For use on:	Catalog number
Prevents the fuse cover from being opened when the switch is in the ON position	FD400- FD800	BDZX204

Terminal shroud

Description	For use on:	Weight (lbs)	Catalog number
Includes one terminal shroud for line or load side	FD400	0.13	BDTSF4
	FD600 – FD800	0.11	BDTSF6

Terminal pole

Description	For use on:	Weight (lbs)	AC thermal amp rating	AC rated voltage	Catalog number
Detachable neutral mounts on side of switch or DIN rail	FD400	1.04	400	600	BDTP85
	FD600 – FD800	1.19	800	600	BDTP88

① UL file #E57057

Fusible

Non-Fused

Enclosed Fused

Enclosed Non-Fused

Fusible

Non-Fused

Enclosed Fused

Enclosed Non-Fused

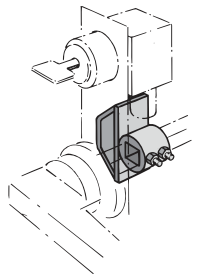

CDETL-ZW5

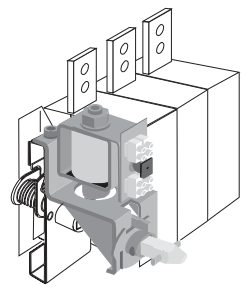

CDETL-ZT80

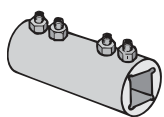

BDZW95

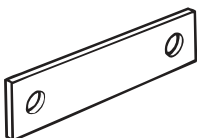

FDSBZK98
FDSBZL79

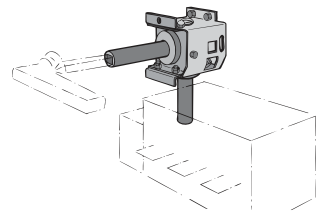

BDZX108

Locking accessories

Description	For use on:	Weight (lbs)	Catalog number
Cam attachment for Kirk Key, Castell, Lowe & Fletcher and Ronis interlock. For adapting to the interlock system. The interlock is not included.	FD400 – FD800	0.29	CDETL-ZW5
Electrical interlock Closed circuit principle for interlocking the switch movement. When the coil circuit is dead, A-types cannot be operated to ON-position and L-types cannot be operated to ON- or OFF-position. Coil voltages 110VAC, 220VAC, 24VDC, 48VDC, 60 VDC 110VDC, 220VDC, P = 15W	FD600 – FD800	2.42	CDETL-ZT80A☒ CDETL-ZT80L☒

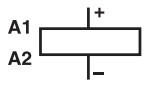

H - Coil voltage

Shaft extension coupler

Description	For use on:	Weight (lbs)	Catalog number
Joins two shafts together for applications where extended length is required	12mm shafts	0.26	BDZW95

Shorting bars

Description	For use on:	AC thermal amp rating	AC rated voltage	Catalog number
Solid links (1 per kit)	FD400	400	600	FDSBZK98
	FD600 – FD800	800	600	FDSBZL79

90° angle kit

Description	For use on:	Weight (lbs)	Catalog number
Converts switch mechanism from front operation to side operation	FD400 – FD800	4.63	BDZX108

Accessories for 400A – 800A Fusible Disconnect Switches

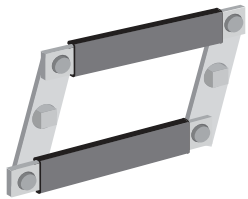

BDZW9

Conversion mechanisms

- Switches are not included

Description	For use on:	Weight (lbs)	Catalog number
6 or 8 pole	FD400 – FD800	2.42	BDZW9

6 or 8 pole — BDZW9

6 (8) pole mechanism allows two switches controlled by one handle, to open or close simultaneously.

Equipment required for a complete installation:

- One conversion mechanism
- Two disconnect switches
- One handle
- One additional shaft

(Only one shaft is included with mechanism)

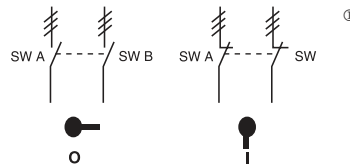

	POS. O	POS. I
SW. A	O	X
SW. B	O	X

X = Closed
O = Open

① = Three poles

Fusible

Non-Fused

Enclosed Fused

Enclosed Non-Fused

UL Fuse Class J, CC, T

For a complete assembly,
please select one of each:

- 1 switch
- 1 handle
- 1 shaft
- 1 terminal lug kit

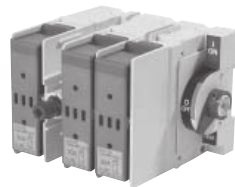

CFD30AJ3S



BDS170



BDH59SH

Fusible

Non-Fused

Enclosed Fused

Enclosed Non-Fused

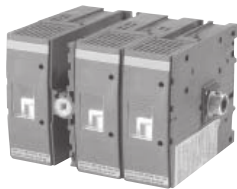

CFD60J3S

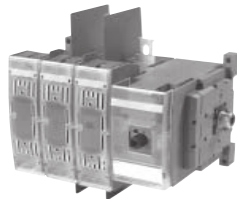

CFD100J3S

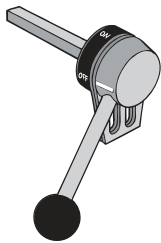

BDZX74



BDS325



BDTL25

Side operated switches — 3 pole

UL general purpose amp rating	UL fuse type 600V	Maximum horsepower rating					Weight (lbs)	Catalog number
		Three phase						
		200V	208V	240V	480V	600V		
30	J	5	7.5	7.5	15	20	1.54	CFD30AJ3S
30	CC	5	7.5	7.5	15	20	1.54	CFD30ACC3S
60	J	15	15	15	30	50	3.52	CFD60J3S
100	J [Ⓞ]	25	25	30	60	75	3.97	CFD100J3S
200	J [Ⓞ]	50	50	60	125	150	15.21	FD200J3-S
400	J [Ⓞ]	100	125	125	250	350	17.20	FD400J3-S

Handles

NEMA type	IEC type	Color	Length inches/mm	Marking	Defeatable	Padlockable	Weight	Catalog number
For use with CFD30J3S & CFD30CC3S								
1, 3R, 12	IP65	Black	2.6/65	OFF/ON/TEST	Yes	Yes	0.29	BDH58SH
1, 3R, 12	IP65	Red/Yellow	2.6/65	OFF/ON/TEST	Yes	Yes	0.29	BDH59SH
For use with CFD60J3S & CFD100J3S								
1, 3R, 12	IP65	Black	3.1/80	OFF/ON/TEST	Yes	Yes	0.30	BDH110SH
1, 3R, 12	IP65	Red/Yellow	3.1/80	OFF/ON/TEST	Yes	Yes	0.30	BDH111SH
For use with FD200J3-S & FD400J3-S								
1, 3R, 12	IP65	Black	4.9/145	OFF/ON/TEST	Yes	Yes	0.39	BDH114SH
1, 3R, 12	IP65	Red/Yellow	4.9/145	OFF/ON/TEST	Yes	Yes	0.39	BDH115SH
1, 3R, 12	IP65	Metal	4.9/145	OFF/ON/TEST	—	Yes	1.50	BDZX74

— = No

Shafts

For use with:	Length (inches/mm)	Description	Weight (lbs.)	Catalog number
CFD30AJ3S & CFD30ACC3S	6.7/170	0.24 x 0.24" (6 x 6mm)	0.08	BDS170
CFD60J3S & CFD100J3S	8.3/210	0.24 x 0.24" (6 x 6mm)	0.13	BDS210
FD200J3-S & FD400J3-S	12.8/325	0.47 x 0.47" (12 x 12mm)	0.90	BDS325

Terminal lug kit

For use on:	Wire size	Kit weight (lbs)	Wire type	Lugs per kit	Catalog number
CFD30J3S & CFD30CC3S	#14 – 4	—	Cu	—	Integral
CFD60J3S	#14 – 4	—	Cu	—	Integral
CFD100J3S	#14 – 2/0	0.43	Cu/Al	6	BDTL24
FD200J3-S	#6 – 300 kcmil	0.93	Cu/Al	6	BDTL25
FD400J3-S	#2 – 600 kcmil	3.50	Cu/Al	6	BDTL26

[Ⓞ] J type fuse clips are standard. If 600V Type "T" fuse clips are desired, please order the "T" type fuse adapter kit.

Flange Operated Fusible Disconnect Switches for 30A – 100A



UL Fuse Class J, CC, T

For a complete assembly,
please select one of each:

- 1 switch
- 1 handle
- 1 shaft
- 1 terminal lug kit

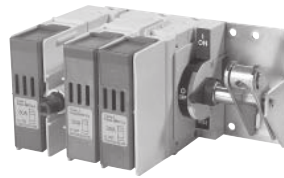

CFD30J3F



BDFHS12



BDFHNHS12

Fusible

Non-Fused

Enclosed Fused

Enclosed Non-Fused

Flange operated switches — 3 pole

UL general purpose amp rating	UL fuse type 600V	Maximum horsepower rating					Weight (lbs)	Catalog number
		Three phase						
		200V	208V	240V	480V	600V		
30	J	5	7.5	7.5	15	20	2.20	CFD30AJ3F
30	CC	5	7.5	7.5	15	20	2.50	CFD30ACC3F
60	J	15	15	15	30	50	3.52	CFD60J3F
100	J	25	25	30	60	75	3.97	CFD100J3F

Handles

NEMA type	Color	Length inches/mm	Marking	Defeatable	Padlockable	Weight (lbs)	Catalog number
1, 3R, 12	Metal	6.9/175	O/I & OFF/ON	Yes	Yes	3.52	BDFHNHS12
4, 4X	Metal	6.9/175	O/I & OFF/ON	Yes	Yes	3.52	BDFHNHS4

Shafts

Shaft length inches	Mounting depth in inches	Weight (lbs)	Catalog number
12		0.39	BDFHS12
17		0.55	BDFHS17
22.5		0.73	BDFHS22

Terminal lug kit

For use on:	Wire size	Kit weight (lbs)	Wire type	Lugs per kit	Catalog number
BDCF30J6_ & BDFLF60J6-F	#14 – #4	—	Cu	—	Standard
BDFLF100J6-F	#14 – 2/0	0.43	Cu/Al	6	BDTL24

Door hardware — NEMA 12

Item	Weight (lbs)	Catalog number
Safety door latch, 2 point with 6" handle	1.92	BDDHK
Roller for 3 point latch, add to FH-DHK	0.39	BD3RL

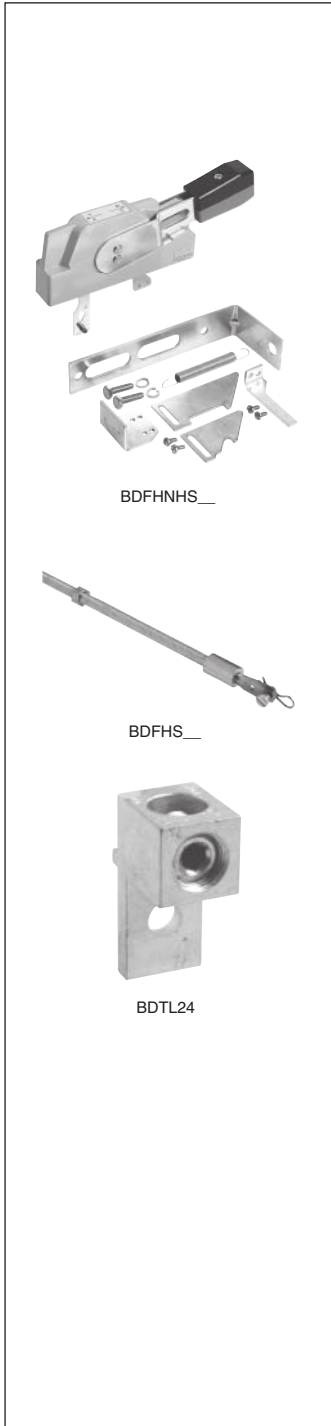

For a complete assembly, please select one each of the following:

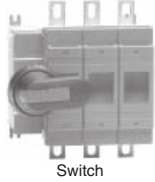

+



+

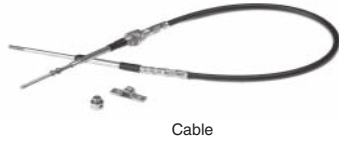

+



+



Fusible

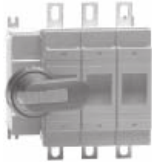

Switch



Handle

Non-Fused

Enclosed Fused



BFCL36 - BFCL108
BK7C048 - BK7C084

Enclosed Non-Fused



Lug kit



BDTL175/400

Fusible

UL general purpose amp rating	UL fuse type 600V	Maximum horsepower rating					Poles	Mechanism Part Number	Switch Part Number
		Three-phase							
		200-208V	240V	480V	600V				
30	CC	5/7.5	7.5	15	20	3	BMKCS2	CFD30ACC3	
30	J	5/7.5	7.5	15	20	3	BMKCS2	CFD30AJ3	
60	J	15	15	30	50	3	BMKCS3	CFD60J3	
100	J/T	25	30	60	75	3	BMKCS4	CFD100AJ3	
200	J	50	60	125	150	3	BMKCS4	CFD200J03	
400	J/T	100	125	250	350	3	Incl.	FD400J3-FC	
600	J/T	150	200	400	500	3	Incl.	FD600J3-FC	
800	L	200	250	500	600	3	Incl.	FD800J3-FC	

Flange handles - UL 98; File #E101914

For use with:	Environmental rating	Catalog number
CFD30 - CFD200	NEMA 1, 3R, 12	BDHFC12
	NEMA 4, 4X	BDHFC4
FD400 - FD-800	NEMA 1, 3R, 12	BK7FCH
	NEMA 4, 4X	BK7FCH4

Flexible cables

For use with:	Cable length (inches)	Catalog number
CFD30 - CFD200	36	BFCL36
	48	BFCL48
	60	BFCL60
	72	BFCL72
	84	BFCL84
	96	BFCL96
	108	BFCL108
FD400 - FD800	48	BK7C048
	60	BK7C060
	72	BK7C072
	84	BK7C084

Terminal lug kits

For use with:	Wire size	Wire type	Description	Lugs per kit	Catalog number
CFD100 - CFD200	#4-300kcmil	Cu/Al	-	6	CDTL200
	#4-300kcmil	Cu/Al	-	3	CDTL200/3P
	(6)#4-6AWG	Cu/Al	Dist. lug	3	CDTL206
FD400J	#2-600kcmil	Cu/Al		6	BDTL26
FD600J - FD800L	(12)#14-16 - 600kcmil	Cu/Al		3	BDTL175/400
FD600J - & FD800L	(2)#2 - 600kcmil	Cu/Al		6	BDTL27

Door hardware — NEMA 12

Item	Catalog number
Safety door latch, 2 point, door less than 40" high	BKDH2R
Safety door latch, 3 point, door greater than 40" high	BKDH3R

UL & cULus Technical Data for Fusible Disconnect Switches



CFD30CC3 - FD800L3

UL & cULus

Catalog number	3 pole	CFD30_3	CFD60J3	CFD100J3	CFD200J03	FD400J3	FD600J3	FD800L3
Approvals ^①	2 pole 3 pole 4 pole	N/A UL98 & IEC UL98 & IEC	N/A UL98 & IEC UL98 & IEC	UL98 & IEC UL98 & IEC UL98 & IEC	UL98 & IEC UL98 & IEC UL98 & IEC	UL98 & IEC UL98 & IEC UL98 & IEC	UL98 & IEC UL98 & IEC UL98 & IEC	UL98 & IEC UL98 & IEC UL98 & IEC
Technical ratings	-40° to 40°C							
General purpose amp rating pf = 0.7 – 0.8	A	30	60	100	200	400	600	800
Max operating voltage	V	600	600	600	600	600	600	600
Max horsepower rating/ Max motor FLA current pf = 0.4 – 0.5								
Three phase								
200 – 208V	HP/A	5/16.8 – 7.5/24.2	15/46.2	25/75.0	50/143.0	100/273 – 125/344	150/396	200/528
240V	HP/A	7.5/22.0	15/42.0	30/80.0	60/145.0	125/312.0	200/480.0	250/602.0
480V	HP/A	15/21.0	30/40.0	60/77.0	125/156.0	250/302.0	400/477.0	500/590.0
600V	HP/A	20/22.0	50/52.0	75/77.0	150/144.0	350/336.0	500/472.0	600/ —
Single phase								
120V	HP/A	2/24.0	—	—	—	—	—	—
240V	HP/A	3/17.0	—	—	—	—	—	—
Short circuit rating with fuse	kA	200	200	200	200	200	200	200
UL Fuse size	A	30	60	100	200	400	600	800
UL Fuse type		J/CC	J	J/T	J	J/T	J/T	L
Endurances								
Min. Electrical endurance, pf = 0.75 – 0.80	operation cycles	6000	6000	6000	6000	1000	1000	500
Mechanical endurance	operation	20,000	20,000	20,000	20,000	12,000	10,000	7000
Physical characteristics								
Weight	3 pole lb 4 pole lb	1.54 1.98	2.86 3.52	3.30 3.96	5.9 7.5	17.2 19.4	37.48 46.3	37.48 46.3
Dimension	3 pole H in W in D in	3.82 4.17 4.21	3.94 5.63 5.04	5.66 7.06 5.09	6.5 7.1 5.2	7.87 11.22 8.11	11.42 14.69 9.21	11.42 14.69 9.21
Shaft size square □	in mm	.24 x .24 6 x 6	.24 x .24 6 x 6	.24 x .24 6 x 6	.24 x .24 6 x 6	.47 x .47 12 x 12	.47 x .47 12 x 12	.47 x .47 12 x 12
Switch operating torque for rotary 3 pole switches	lb. in.	26.6	35.5	70.9	195	195	248	248
Terminal lug kits								
Wire range	AWG	#18 – 8	#14 – 4	BDTL24 #14 – 2/0	CDTL200 #4 – 300kcmil	BDTL26 #2 – 600kcmil	BDTL27 (2) #2 – 600 kcmil	BDTL27 (2) #2 – 600 kcmil
Torque:								
Wire tightening	lb. in.	17	30	120	275	500	375	375
Lug mounting	lb. in.	N/A	N/A	50	150	480	500	480
Auxiliary contacts								
NEMA ratings, AC		—	A600	A600	A600	A600	A600	A600
AC rated voltage	VAC	250	600	600	600	600	600	600
AC thermal rated current	A	6	10	10	10	10	10	10
AC maximum volt ampere making	VA	—	7200	7200	7200	7200	7200	7200
AC maximum volt ampere breaking	VA	—	720	720	720	720	720	720
NEMA ratings, DC		—	P300	R300	R300	R300	P600	P600
DC rated voltage	VDC	—	300	300	300	300	600	600
DC thermal rated current	A	—	1	1	1	5	5	5
DC maximum make break current	A	—	28	28	28	138	138	138
Torque:								
Wire tightening	lb. in.	7	7	7	7	7	7	7
Wire range	AWG	#22 – 14/#18 – 14	#18 – 14	#22 – 14	#18 – 14	#22 – 14	#22 – 14	#22 – 14

Fusible

Non-Fused

Enclosed Fused

Enclosed Non-Fused

^① The following UL Listed switches are also cULus approved.

CFD30CC3 - FD800L3

IEC

Catalog number	3 pole	CFD30_3	CFD60J3	CFD100J3	CFD200J03	FD400J3	FD600J3	FD800L3
Technical ratings	-40° to 40°C							
Rated insulation voltage ^① Pollution degree 3 ^② V	1000	1000	1000	1000	1000	1000	1000	
Dielectric strength 50Hz/60Hz, 1 min	kV	10	10	10	10	10	10	10
Rated impulse withstand voltage	kV	12	12	12	12	12	12	12
Rated thermal current, I _{th} / max. fuse power dissipation ^③								
AC 20/DC 20 open ^④	A/W	32/3.5	63/7.5	160/12	200/17	400/45	630/60	800/65
40°C enclosed	A/W	32/3.5	63/7.5	160/10, 135/12	200/17	400/34, 360/37	600/45, 570/50	720/55
Enclosed with solid links	A/W	32	85	175	280	450	700	900
with minimum cable cross section Cu	mm ²	6	16	70	95	240	2 x 185	2 x 240
Rated operational voltage AC 20 and DC 20V		1000	1000	1000	1000	1000	1000	1000
AC Rated operational currents								
AC 21A	500V A	32	63	160	200	400	630	800
	690V A	32	63	160	200	400	630	800
AC 22A	500V A	32	63	160	200	400	630	800
	690V A	32	63	160	200	400	630	800
AC 23A	500V A	32	63	160	200	400	630	720
	690V A	32	63 ^⑤	160 ^⑥	200	400	630	720
DC Rated operational currents/poles in series								
DC21A	48V ^⑦ A	32/2	⊙	⊙	200/1	400/2	630/2	800/2
	110V A	32/2	⊙	⊙	200/1	400/2	630/2	800/2
	220V A	32/2	⊙	⊙	200/1	400/2	630/2	800/2
	440V A	32/4	⊙	⊙	200/2	400/2	630/2	800/2
	750V A	—	⊙	⊙	180/4	400/3	630/1	800/3
	1000V A	—	⊙	⊙	—	400/4	630	800/4
DC22A	48V ^⑦ A	32/2	⊙	⊙	200/1	400/2	630/2	800/2
	110V A	32/2	⊙	⊙	200/1	400/2	630/2	800/2
	220V A	32/2	⊙	⊙	200/1	400/2	630/2	800/2
	440V A	32/4	⊙	⊙	200/2	400/2	630/2	800/2
	750V A	—	⊙	⊙	180/4	400/3	630/3	800/3
	1000V A	—	⊙	⊙	—	400/4	630/4	800/4
DC23A	48V ^⑦ A	32/2	⊙	⊙	200/1	400/2	630/2	800/2
	110V A	32/2	⊙	⊙	200/1	400/2	630/2	800/2
	220V A	32/2	⊙	⊙	200/1	400/2	630/2	800/2
	440V A	32/4	⊙	⊙	200/2	400/2	630/2	800/2
	750V A	—	⊙	⊙	180/4	400/3	630/3	800/3
	1000V A	—	⊙	⊙	—	—	630/4	800/4
Rated operational power AC23A								
	230V kW	8	18.5	45	60	110	180	200
	400V kW	14	30	80	110	210	315	350
	415V kW	15	30	90	110	230	340	380
	500V kW	18	37	110	140	280	400	470
	690V kW	25	60	132	190	330	540	600

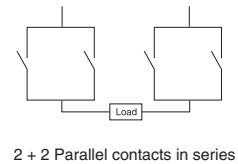
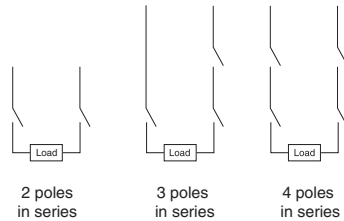

① 1000V, IEC 408.
 ② Ambient temperature 60°C: derating 20 percent. Mounting on ceiling: derating 10 percent. Mounting on wall, horizontal fuses: derating 8 percent.
 ③ The ambient air temperature does not exceed +40°C and its average over a period of 24h does not exceed +35°C according to IEC 947.
 ④ For 30A switches, use 2 parallel contacts in series.
 ⑤ Available on request.
 ⑥ IEC 947-3, utilization category B, infrequent operation.
 ⑦ Pollution degree 3: Conductive pollution occurs, or dry, non-conductive pollution occurs, which becomes conductive due to condensation.

IEC Technical Data for Fusible Disconnect Switches



CFD30CC3 - FD800L3

IEC

Catalog number	3 pole	CFD30_3	CFD60J3	CFD100J3	CFD200J03	FD400J3	FD600J3	FD800L3
Rated breaking capacity								
in category AC-23A	500V A	256	504	1280	1600	3200	5760	5760
	690V A	256	504	1280	1600	3200	5760	5760
Rated breaking capacity/poles in series								
in category DC-23	<220V A	128/2	—	—	1000/2	1600/2	3200/2	3200/2
	440V A	128/4	—	—	1000/2	1600/2	3200/2	3200/2
	500 – 750V A	—	—	—	1000/3	1600/3	3200/3	3200/3
	1000V A	—	—	—	—	—	3200/4	3200/4
Rated conditional short-circuit current r.m.s. ^①								
	80 kA, 415V kA	9	17	22	35	40	75	75
	100 kA, 500 V kA	7.5	17	22	37.5	40	75	75
	50 kA, 690 V kA	6	13	15	35	35	60	60
Rated short time withstand current, 1s.	kA	1	2.5	5	8	10	16	16
Rated capacitor power								
– The capacitor rating of the fusible disconnect switch is limited by the fuse link								
	400 V kVar	15	30	—	—	180	250	310
	415V kVar	15	32	—	—	200	270	340
	690V kVar	25	50	—	—	325	450	550
Power loss/pole								
with rated current, without fuse	W	2	4	9	8	30	55	77
Mechanical endurance	operations	20,000	20,000	20,000	20,000	16,000	10,000	10,000
Fuse types, IEC 269-2	DIN 43620	—	000, 00	000, 00	—	0 – 2	3	3
	NFC	10 x 38, 14 x 51	14 x 51, 22 x 58	22 x 58	—	0 – 2	3	—
	BS 88	A1, A2, F1	A2 – A3	A2 – A4	B1 – B2	B1 – B4	C1 – C2	C1 – C3
size/distance of link bolts		M4/44.5(A1) M5/73(A2)	M5/73	M5/73 M8/94	M6/111	M3/111	M10/133, 184	M10/133, 184
Physical characteristics								
Weight	3 pole	0.7	1.3	1.5	2.6	7.8	17.0	17.0
	4 pole	0.9	1.6	1.8	7.9	8.8	21.0	21.0
Dimension	3 pole H	97	100	144	198.5	226	282	282
	W mm	106	174	179	181.5	284	373	373
	D mm	107	123	129	132	198	221	221
Shaft size	square □ mm	6 x 6	6 x 6	6 x 6	6 x 6	12 x 12	12 x 12	12 x 12
Terminals								
Built-in terminal size	mm ²	0.5 – 10	2.5 – 25	—	—	—	—	—
Terminal bolt size, metric thread								
diameter x length	mm	—	—	M6 x 20	M8 x 25	M10 x 40	M12 x 40	M12 x 40
Terminal bolt tightening torque	Nm	2	3.5	6 – 9	15 – 22	30 – 44	50 – 75	50 – 75
Fuse-links bolts tightening torque	Nm	2	3.5	3.5 – 5	4	15	40	40
Operating torque	Nm	3	4	8	7	22	28	28
Auxiliary contacts								
		①	②	③	④	⑤		
Ratings according to IEC 947-5-1								
Rated voltage, Ui	VAC	690	690	690	690	690	690	690
Thermal current, Ith	A	10	16	16	16	16	10	10
AC12 / DC12, Ie	Ue= 24V A	—/6	—	—	—	—	—	—
	120V A	—/6	—	—	—	8/—	8/—	8/—
	125V A	—	—	—	—	—/1.1	—/1.1	—/1.1
	230V A	—	6/—	6/—	6/—	6/—	6/—	6/—
	250V A	3/0.1	—	—	—	—/0.55	—/0.55	—/0.55
	400V A	—	4/—	4/—	4/—	4/—	4/—	4/—
	415V A	—	—	—	—	4/—	4/—	4/—
	440V A	2/—	—	—	—	—/0.31	—/0.31	—/0.31
	480V A	—	—	—	—	3/—	3/—	3/—
	500V A	—	—	—	—	3/0.27	3/0.27	3/0.27
	600V A	—	—	—	—	—/0.2	—/0.2	—/0.2
	690V A	—	2/—	2/—	2/—	2/—	2/—	2/—

Fusible

Non-Fused

Enclosed Fused

Enclosed Non-Fused

① AC15 / DC12, according to IEC 947-5-1
 ② AC15 / DC13, according to IEC 947-5-1
 ③ AC15, according to IEC 947-5-1
 ④ AC11 / DC11, according to IEC 947-5-1
 ⑤ Values shown are corresponding max. allowed cut-off current, peak-values per single phase fuse tests.

CFD30AJ3 - CFD60J3

CFD30AJ3 & CFD30ACC3

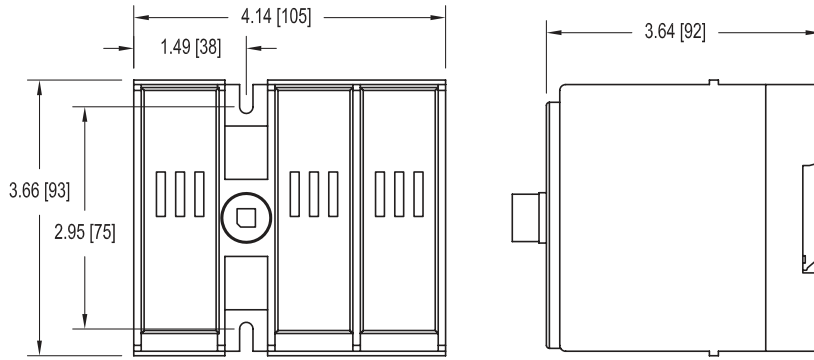

Fusible

Non-Fused

CFD60J3

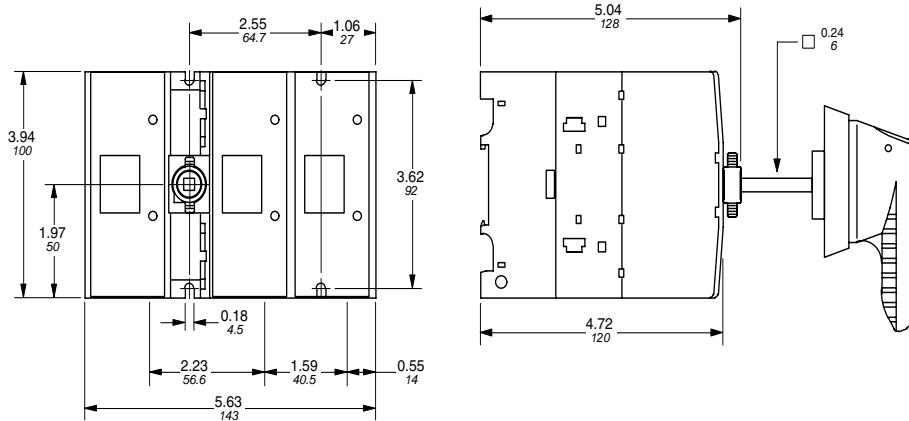

Enclosed Fused

Enclosed Non-Fused

Approximate Dimensions for Fusible Disconnect Switches

COOPER Bussmann

CFD100J3 - CFD200J03

CFD100J3

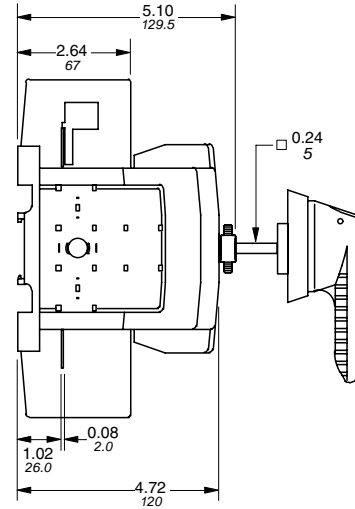
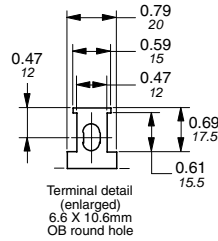
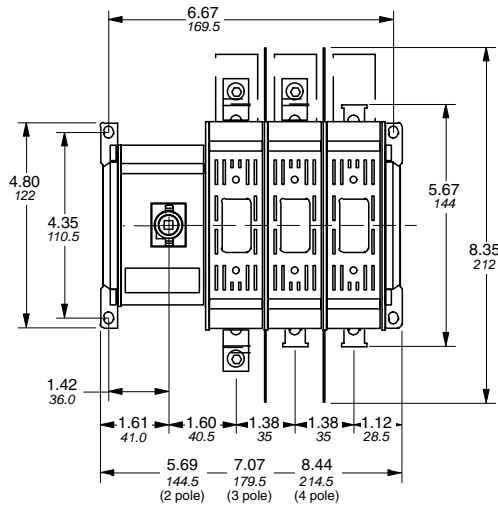

CFD200J03

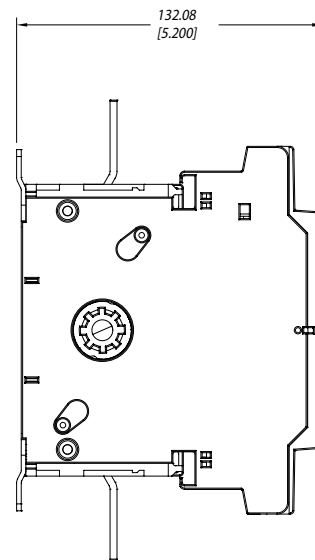
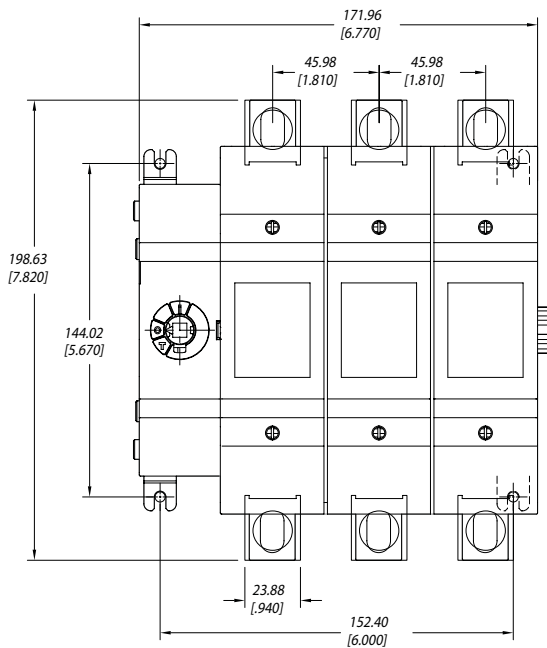

Fusible

Non-Fused

Enclosed Fused

Enclosed Non-Fused

FD400J3 – FD800J3

FD400J3

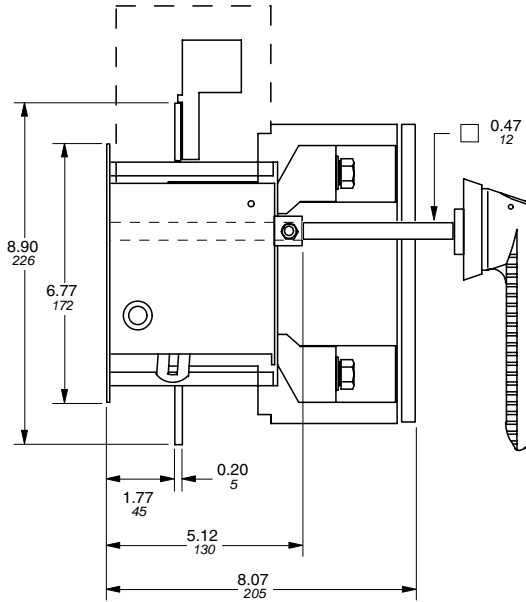
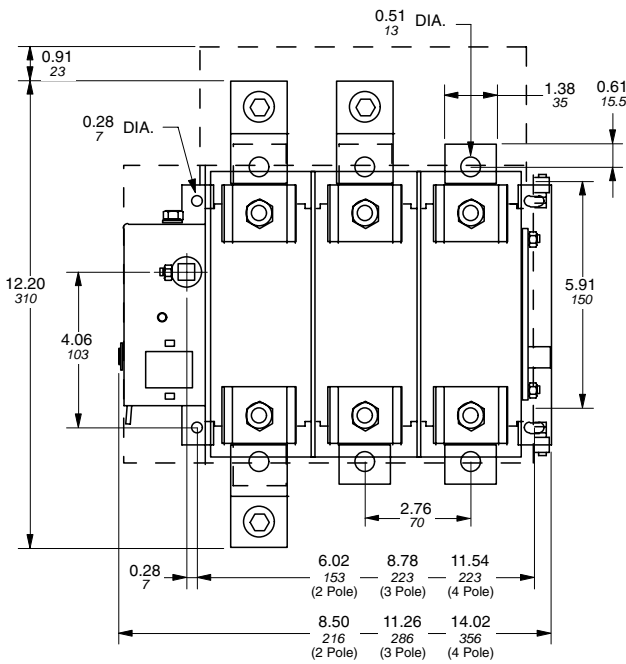

Fusible

Non-Fused

FD600J3 & FD800L3

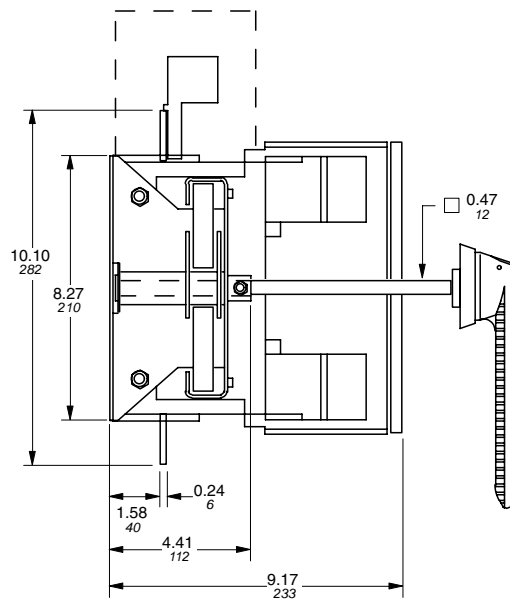
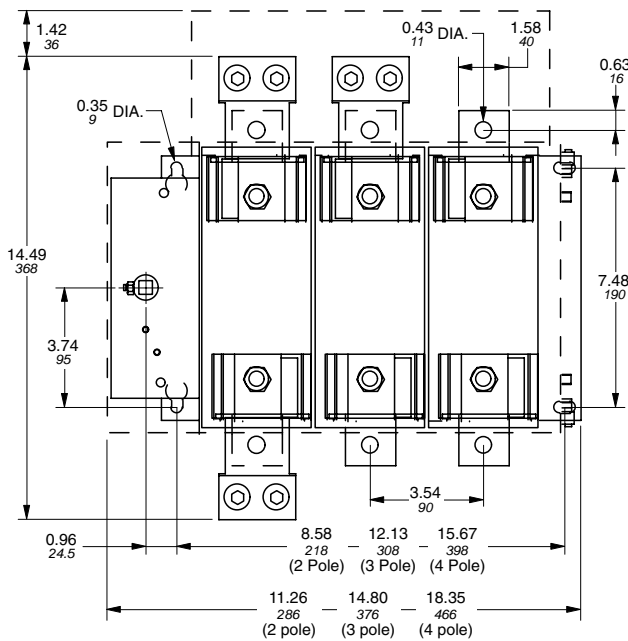

Enclosed Fused

Enclosed Non-Fused

Approximate Dimensions for Terminal Lugs



BDTL24 — for use with 100A switches

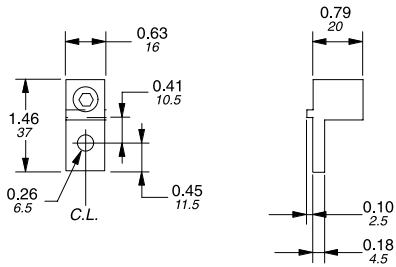

BDTL26 — for use with 400A switches

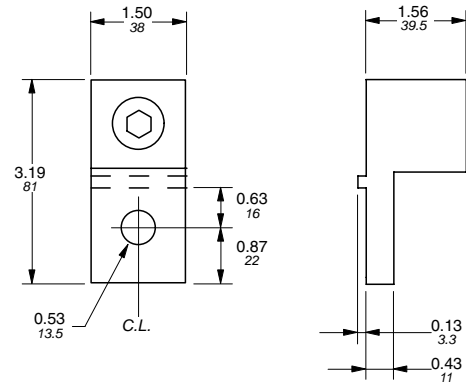

CDTL200 — for use with 200A switches

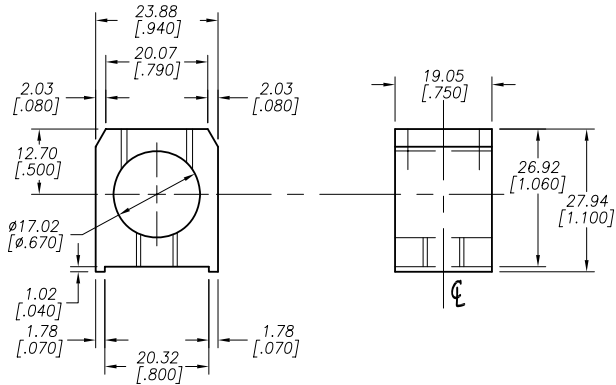

BDTL27 — for use with 600A switches

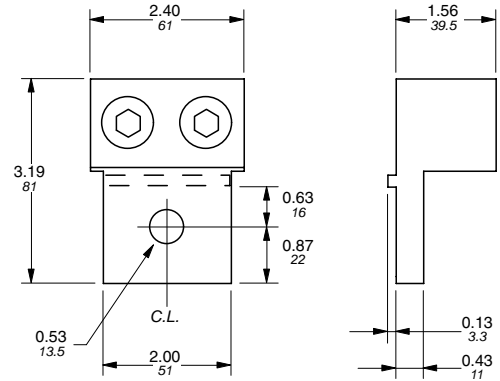

CDTL206 — power distribution lug, for 200A switch

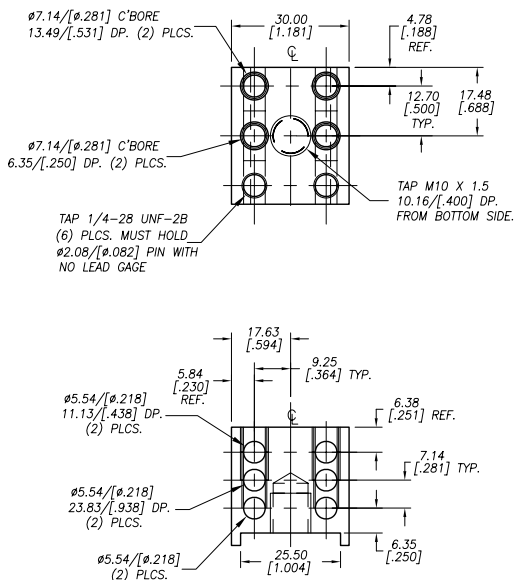

BDTL175/400 — distributor lug kit for use with 600A & 800A switches

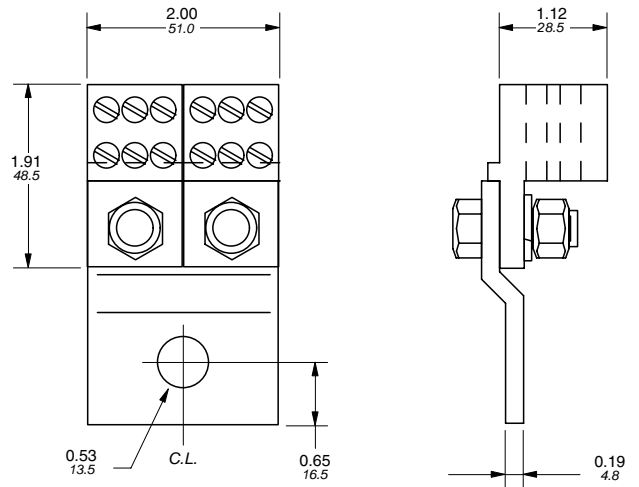

Fusible

Non-Fused

Enclosed Fused

Enclosed Non-Fused

30A 6 pole — BDZW6

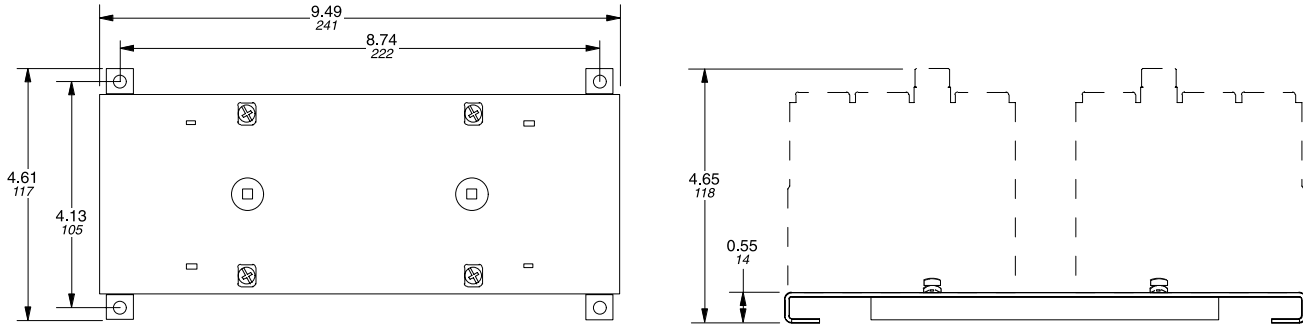

Fusible

60A - 200A 6 or 8 pole — BDZW2

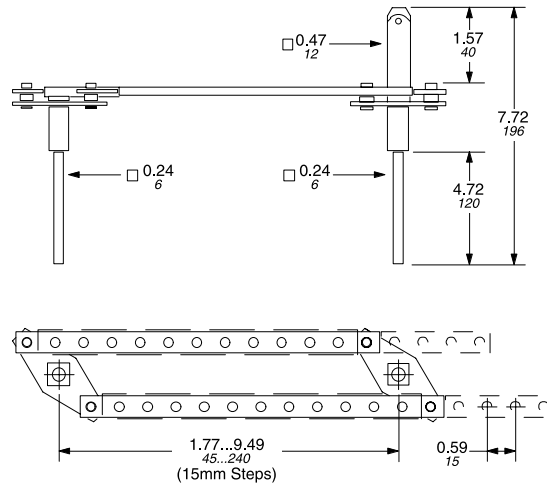

Non-Fused

Enclosed Fused

400 - 800A 6 or 8 pole — BDZW9

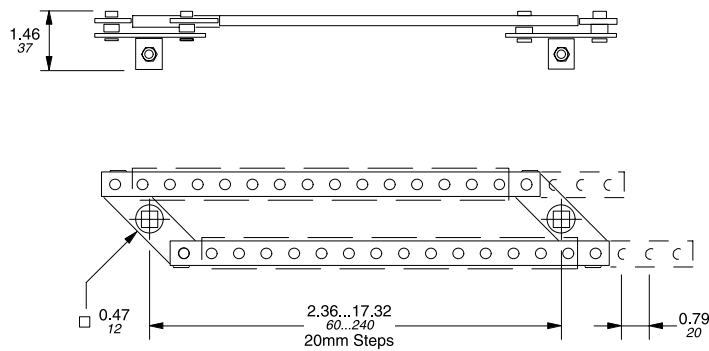

Enclosed Non-Fused

Overview for Non-Fusible Disconnect Switches



CDNF16 - CDFN100A3

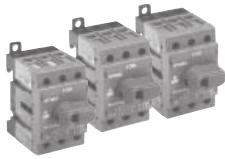

CDNF16A3, CDFN25A3, CDFN32A3

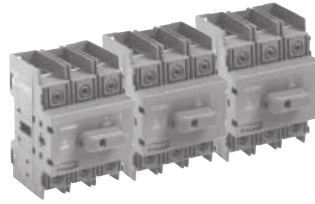

CDNF30A3, CDFN60A3, CDFN100A3

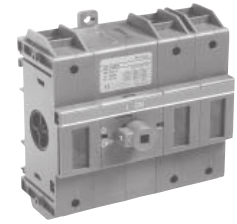

CDNF160

Catalog number	3 pole	CDNF16A3	CDNF25A3	CDNF32A3	CDNF45A3	CDNF63A3	CDNF30A3	CDNF60A3	CDNF100A3	
General purpose amp rating	A	16	25	40	60	80	30	60	100	
Approvals ^①										
	2 pole	N/A	N/A	N/A	N/A	N/A	N/A	N/A	N/A	
	3 pole	UL508	UL508	UL508	UL508	UL508	UL98	UL98	UL98	
	4 pole	UL508	UL508	UL508	UL508	UL508	UL98	UL98	UL98	
Technical ratings										
UL, cULus^②										
Max operating voltage	V	600	600	600	600	600	600	600	600	
Max horsepower rating										
Three phase										
200 – 208V	HP	3	7.5	10	15	20	10	20	25	
240V	HP	5	7.5	10	15	20	10	20	30	
480V	HP	10	15	20	30	40	20	40	50	
600V	HP	10	20	25	30	40	30	40	50	
Single phase										
120V	HP	1/2	3/4	1	2	2	2	3	5	
240V	HP	1.5	2	3	5	5	5	7.5	15	
Technical ratings										
IEC^③										
Rated insulation and operational voltage. AC20 and DC20 ^④	V	750	750	750	750	750	750	750	750	
Rated thermal current, I _{th}										
AC 20/DC 20 open	A	25	32	40	63	80	40	63	115	
AC 20/DC 20 enclosed	A	25	32	40	63	80	40	63	115	
AC 21A 500V	A	16	25	32	63	80	40	63	100	
690V	A	16	25	32	63	80	40	63	100	
Rated operational power AC23										
400/415V	kW	7.5	9	11	22	37	15	18.5	37	
690V	kW	7.5	9	11	15	18.5	15	15	37	
Physical characteristics										
Weight ^④	3 pole lb	0.24	0.24	0.24	0.59	0.59	0.79	0.79	0.79	
Dimension	3 pole H in	2.68	2.68	2.68	3.60	3.60	3.94	3.94	3.94	
	W in	1.38	1.38	1.38	2.07	2.07	2.76	2.76	2.76	
	D in	2.20	2.20	2.20	2.85	2.85	2.95	2.95	2.95	
Accessories										
Terminal lug kit		Integral	Integral	Integral	Integral	Integral	Integral	Integral	Integral	
Terminal shroud		•	•	•	•	•	•	•	•	
Auxiliary contact		•	•	•	•	•	•	•	•	
Handle UL/NEMA type										
Type 1, 3R, 12		•	•	•	•	•	•	•	•	
Type 1, 3R, 4, 4X, 12		•	•	•	•	•	•	•	•	
Handle type										
Selector		•	•	•	•	•	—	—	—	
Pistol		•	•	•	•	•	•	•	•	
Conversion kits										
6 pole		•	•	•	•	•	•	•	•	
Transfer		•	•	•	•	•	•	•	•	
Bypass		•	•	•	•	•	•	•	•	
Mechanical interlock		•	•	•	•	•	•	•	—	
Electrical interlock		—	—	—	—	—	—	—	—	

• = Available
— = Not available

UL Listed, cULus approved, IEC rated, CE marked

- ① UL Listed switches are also cULus approved.
- ② For complete technical information please see page 58 & 59.
- ③ 1000V, IEC 408.
- ④ Switch only

Fusible

Non-Fused

Enclosed Fused

Enclosed Non-Fused

CDNF200U03 - BDNF3150

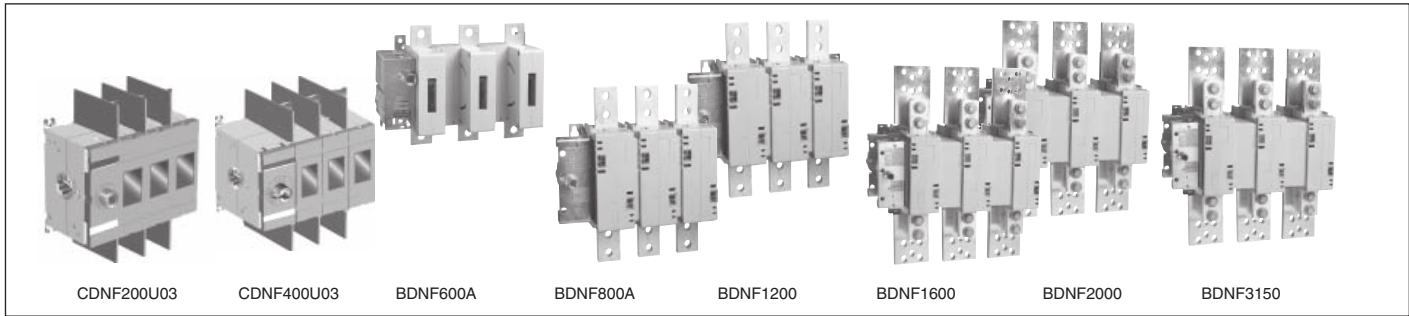

Fusible

Non-Fused

Enclosed Fused

Enclosed Non-Fused

Catalog number	3 pole	CDNF200U03	CDNF400U03	BDNF600A	BDNF800A	BDNF1200	BDNF1600	BDNF2000	BDNF3150
General purpose amp rating	A	200	400	600	800	1200	1600	2000	3150
Approvals ^①									
	2 pole	UL98 & IEC	UL98 & IEC	UL98 & IEC	UL98 & IEC	UL98 & IEC	UL98 & IEC	UL98 & IEC	IEC
	3 pole	UL98 & IEC	UL98 & IEC	UL98 & IEC	UL98 & IEC	UL98 & IEC	UL98 & IEC	UL98 & IEC	IEC
	4 pole	IEC	UL98 & IEC	UL98 & IEC	IEC	IEC	IEC	IEC	IEC
Technical ratings UL, cULus^②									
Max operating voltage	V	600	600	600	600	600	600	600	600
Max horsepower rating									
Three phase									
200 – 208V	HP	60	100	150	200	—	—	—	—
240V	HP	75	125	200	250	—	—	—	—
480V	HP	150	250	400	500	—	—	—	—
600V	HP	200	350	500	600	—	—	—	—
Single phase									
120V	HP	—	—	—	—	—	—	—	—
240V	HP	—	—	—	—	—	—	—	—
Technical ratings IEC^③									
Rated insulation and operational voltage. AC20 and DC20 ^④	V	1000	1000	1000	1000	1000	1000	1000	1000
Rated thermal current, I _n									
AC 20/DC 20 open	A	250	400	800	1250	1600	2500	2500	3150
AC 20/DC 20 enclosed	A	250	400	720	1250	1600	2300	2300	2600
AC 21A 500V	A	250	400	800	1250	1600	2500	2500	3150
690V	A	250	400	800	1250	1600	2500	2500	3150
Rated operational power AC23									
400/415V	kW	132	220	355	400	400	400	400	400
690V	kW	240	355	355	—	—	—	—	—
Physical characteristics									
Weight ^⑤	3 pole lb	2.90	5.70	13.66	35.9	38.55	127.7	127.7	127.7
Dimension	3 pole								
	H in	6.69	8.66	11.77	19.09	19.09	25.04	25.04	25.04
	W in	6.67	8.70	11.93	14.29	14.29	18.43	18.43	18.43
	D in	3.30	4.15	5.12	4.92	4.92	10.67	10.67	10.67
Accessories									
Terminal lug kit		CDTL200	CDTL400	BDTL27	BDTL30	BDTL28	BDTL28	BDTL28/2	BDTL28/2
Terminal shroud		•	•	•	•	•	—	—	—
Auxiliary contact		•	•	•	•	•	•	•	•
Handle UL/NEMA type									
Type 1, 3R, 12		•	•	•	•	•	•	•	•
Type 1, 3R, 4, 4X, 12		•	•	•	•	•	•	•	•
Handle type									
Selector		—	—	—	—	—	—	—	—
Pistol		•	•	•	•	•	•	•	•
Conversion kits									
6 pole		•	•	•	•	•	—	—	—
Transfer		•	•	•	•	•	—	—	—
Bypass		•	•	•	•	•	—	—	—
Mechanical interlock		•	•	•	•	•	•	•	•
Electrical interlock		•	•	•	•	•	•	•	•

S = Standard feature
 • = Available
 — = Not available
UL Listed, cULus approved, IEC rated, CE marked
 ① UL Listed switches are also cULus approved.
 ② For complete technical information please see page 58 & 59.
 ③ 1000V, IEC 408.
 ④ Switch only

16A – 100A

for Non-Fusible Disconnect Switches



For a complete assembly,
please select one of each:

- 1 switch
- 1 handle
- 1 shaft



CDNF63A3



BDS85S



CDBH3S

16 – 100 Amp switches, 600V, 3 pole^①

UL general purpose amp rating	IEC AC21 amp rating	Maximum horsepower rating						Terminal lugs		Catalog number
		Single phase		Three phase			Wire size	Wire type		
		120V	240V	200V	240V	480V			600V	
16	16	1/2	1.5	3	5	10	10	#18 – 8	Cu	CDNF16A3
25	25	3/4	2	7.5	7.5	15	20	#18 – 8	Cu	CDNF25A3
40	40	1	3	10	10	20	25	#18 – 8	Cu	CDNF32A3
60	63	2	5	15	15	30	30	#14 – 4	Cu	CDNF45A3
80	80	2	5	20	20	40	40	#14 – 1	Cu	CDNF63A3
30	40	2	5	10	10	20	30	#14 – 4	Cu	CDNF30A3
60	63	3	7.5	20	20	40	40	#14 – 4	Cu	CDNF60A3
100	115	5	15	25	30	50	50	#8 – 1/0	Cu	CDNF100A3

Selector handles — for use with shafts .24 x .24" (6 x 6mm)

NEMA type	IEC type	Color	Defeatable	Padlockable	Weight (lbs)	Catalog number
All marked both O/I & Off/On						
1	IP54	Black	—	—	0.09	CBDH1S ^②
1	IP54	Red/Yel	—	—	0.09	CBDH2S ^②
1	IP54	Black	—	Yes	0.12	CBDH15S ^②
1	IP54	Red/Yel	—	Yes	0.12	CBDH16S ^②
1,3R,12	IP65	Black	—	Yes	0.16	CBDH3S
1,3R,12	IP65	Red/Yel	—	Yes	0.16	CBDH4S
1,3R,12	IP65	Black	Yes	Yes	0.16	CBDH5S
1,3R,12	IP65	Red/Yel	Yes	Yes	0.16	CBDH6S

Shafts — for use with CDH selector handles .24 x .24" (6 x 6mm)

Shaft length inches/mm	Mounting depth ^③ in inches						Weight (lbs)	Catalog number
	CDNF16 CDNF25 CDNF32		CDNF45 CDNF63		CDNF30 CDNF60 CDNF100			
	CBDH1S, CBDH2S	CBDH3S, CBDH4S	CBDH1S, CBDH2S	CBDH3S, CBDH4S	CBDH3S, CBDH4S	CBDH3S, CBDH4S		
	CBDH15S, CBDH16S	CBDH5S, CBDH6S	CBDH15S, CBDH16S	CBDH5S, CBDH6S	CBDH5S, CBDH6S	CBDH5S, CBDH6S		
3.3/85	4.2 – 5.0	3.6 – 4.3	4.9 – 5.6	4.4 – 5.0	3.9 – 4.9	0.04	BDS85S	
4.1/105	5.0 – 5.8	4.4 – 5.1	5.7 – 6.4	5.1 – 5.8	4.7 – 5.7	0.04	BDS105S	
4.7/120	5.6 – 6.4	5.0 – 5.8	6.3 – 7.0	5.7 – 6.4	5.3 – 6.3	0.05	BDS120S	
5.1/130	6.0 – 6.7	5.4 – 6.1	6.7 – 7.4	6.1 – 6.8	5.6 – 6.7	0.05	BDS130S	
7.1/180	7.1 – 8.7	7.4 – 8.1	8.6 – 9.4	8.1 – 8.7	7.6 – 8.6	0.08	BDS180S	
9.8/250	10.7 – 11.5	10.1 – 10.8	11.4 – 12.1	10.9 – 11.5	10.4 – 11.4	0.10	BDS250S	
13/330	13.8 – 14.6	13.3 – 14.0	14.6 – 15.3	14.0 – 14.7	13.5 – 14.5	0.14	BDS330S	

① A snap on fourth pole may be added
 ② Not suitable for use with CDFN30, 60, 100A3.
 ③ Mounting depth is the distance from the outside of door to the disconnect switch mounting plate. Shaft can be cut to desired length.



CDNF16A3
CDNF25A3
CDNF32A3



CDNF30A3
CDNF60A3
CDNF100A3



CDBH1S



CDBH15S



CDBH6S



BDS_S

Fusible

Non-Fused

Enclosed Fused

Enclosed Non-Fused

Base & DIN Rail Mounted



BDH56, 58



BDH57



BDS_

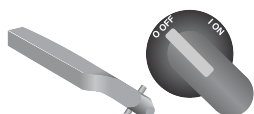

BDST_



CDRKBS12



CDBY68419-6-2M



CDMCS2

Pistol handles — for use with shafts $\square .24 \times .24"$ ($\square 6 \times 6\text{mm}$)

NEMA type	IEC type	Color	Marking	Length inches/mm	Defeatable	Padlockable	Weight (lbs.)	Catalog number
1,3R,12	IP65	Black	O/I & Off/On	1.8/45	Yes	Yes	0.28	BDH56
1,3R,12	IP65	Red/Yel	O/I & Off/On	1.8/45	Yes	Yes	0.28	BDH57
1,3R,12	IP65	Black	O/I & Off/On	2.6/65	Yes	Yes	0.29	BDH58
1,3R,12	IP65	Red/Yel	O/I & Off/On	2.6/65	Yes	Yes	0.29	BDH59
1,3R,12,4,4X	IP66	Black	O/I & Off/On	2.6/65	Yes	Yes	0.29	CDHXB65L6
1,3R,12,4,4X	IP66	Red/Yel	O/I & Off/On	2.6/65	Yes	Yes	0.29	CDHXY65L6

Shafts — for use with pistol handles $\square .24 \times .24"$ ($\square 6 \times 6\text{mm}$)



Shaft length	Mounting depth ^① in inches			Weight	Catalog
	CDNF16A3 CDNF25A3	CDNF45A3	CDNF30A3 CDNF60A3		
5.9/150	6.2 – 6.7	6.9 – 7.4	6.4 – 7.4	0.07	BDS150
6.7/170	7.0 – 7.5	7.7 – 8.1	7.2 – 8.1	0.08	BDS170
10.4/265	10.7 – 11.3	11.4 – 11.9	10.9 – 11.9	0.12	BDS265
15.8/400	16.0 – 16.6	16.8 – 17.2	16.2 – 17.2	0.18	BDS400
19.7/500	20.0 – 20.5	20.7 – 21.1	20.1 – 21.1	0.23	BDS500

Twisted shafts — Rotates handle 45° $\square .24 \times .24"$ ($\square 6 \times 6\text{mm}$)



Shaft length (inches/mm)	Mounting depth ^① in inches			Weight (lbs.)	Catalog number
	CDNF16A3 CDNF25A3 CDNF32A3	CDNF45A3 CDNF63A3	CDNF30A3 CDNF60A3 CDNF100A3		
5.9/130	6.2 – 6.7	6.9 – 7.4	6.4 – 7.4	0.07	BDST4
8.3/210	7.0 – 7.5	7.7 – 8.1	7.2 – 8.1	0.08	BDST25
11.4/290	10.7 – 11.3	11.4 – 11.9	10.9 – 11.9	0.12	BDST29
14.2/360	16.0 – 16.6	16.8 – 17.2	16.2 – 17.2	0.18	BDST30

Replacement knob — mounts directly to switch; no shaft necessary

NEMA	Color	For use	Length	Padlockable	Catalog
1	Black	CDNF16, 25, 32A3	1.0	—	CDRKBS12
1	Black	CDNF30, 45, 60, 63, 100A3	1.4	Yes	CDBY68419-6-2M
Metal collar		CDNF16 – CDNF100A3	—	—	CDMCS2
Set screw		CDNF16, 25, 30, 32, 45, 60, 63, 100A3	—	—	CDSWM5X8A

① Mounting depth is the distance from the outside of door to the disconnect switch mounting plate. Shaft can be cut to desired length.

Accessories

for 16A – 100A Non-Fusible Disconnect Switches

COOPER Bussmann
Base & DIN Rail Mounted

Base and DIN rail mounted switches

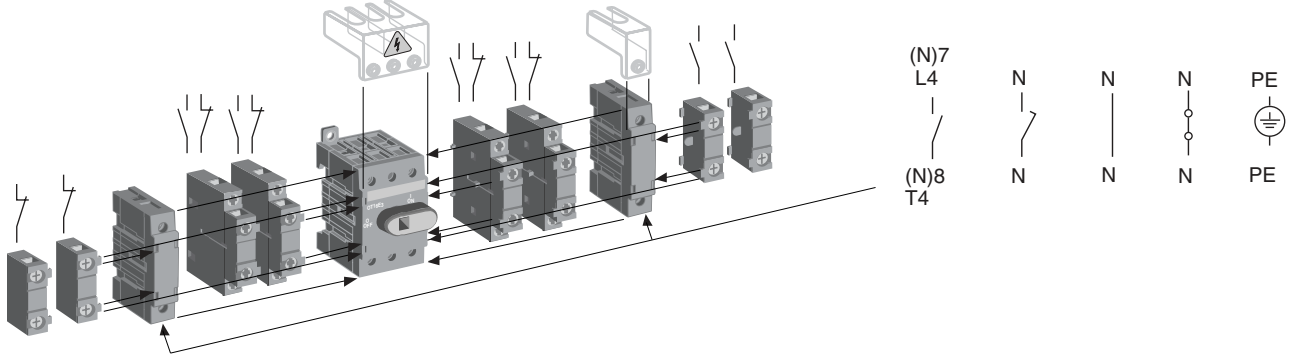

Fusible

Non-Fused

Enclosed Fused

Enclosed Non-Fused

Auxiliary contacts^① — snap-on mounting

Description	For use on:	Weight (lbs.)	AC thermal amp rating	AC rated voltage	Catalog number
1 N.O. mounts on right hand side of switch only	CDNF16 – CDNF100A3	0.07	10	600	CDAUX10
1 N.C. mounts on left hand side of switch only	CDNF16 – CDNF100A3	0.07	10	600	CDAUX01
1 N.O. + 1 N.C. mounts on left or right hand side of switch	CDNF16 – CDNF100A3	0.07	10	600	CDAUX11

Max. two contacts on each side of switch

Power poles

- Only one power pole per switch
- Mounts on left or right side of switch

Description	For use on:	Weight (lbs.)	AC thermal amp rating	AC rated voltage	Catalog number
Fourth pole ^②	CDNF16 - CDNF32A3	0.07	40	600	CDS32PP
	CDNF30 - 60A3	0.13	60	600	CDS60PP
	CDNF45 - 63A3	0.13	80	600	CDS63PP
	CDNF - 100A3	0.31	100	600	CDS125PP
Late-break/early-make ^②	CDNF16 - CDNF32A3	0.07	40	600	CDL32PP
	CDNF30 - 60A3	0.13	60	600	CDL60PP
	CDNF45 - 63A3	0.13	80	600	CDL63PP
	CDNF - 100A3	0.31	100	600	CDL125PP

Terminal poles

- Switch accepts one terminal pole per side
- Mounts on left or right side of switch

Description	For use on:	Weight (lbs.)	AC thermal amp rating	AC rated voltage	Catalog number
Solid neutral ^②	CDNF16 - 32A3	0.07	40	600	CDN32TP
	CDNF45 - 63A3	0.13	80	600	CDN63TP
	CDNF - 100A3	0.31	100	600	CDN125TP
Detachable neutral ^②	CDNF16 - 32A3	0.07	40	600	CDD32TP
	CDNF30 - 60A3	0.13	60	600	CDD60TP
	CDNF45 - 63A3	0.13	80	600	CDD63TP
	CDNF - 100A3	0.31	100	600	CDD125TP
Ground terminal ^②	CDNF16 - 32A3	0.07	40	600	CDE32TP
	CDNF30 - 60A3	0.13	60	600	CDE60TP
	CDNF45 - 63A3	0.13	80	600	CDE63TP
	CDNF - 100A3	0.31	100	600	CDE125TP

① UL File # E83510

② Switch accepts one power pole or one terminal pole per side. Only one power pole per switch.

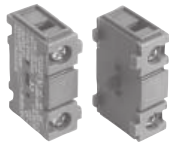

CDAUX10

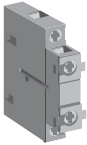

CDAUX01

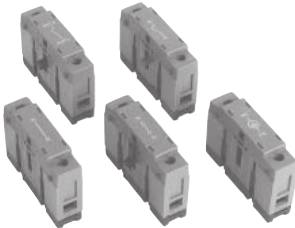

CD_32PP

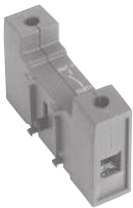

CD_63PP



CD_125PP

Base & DIN Rail Mounted

Fusible

Non-Fused

Enclosed Fused

Enclosed Non-Fused

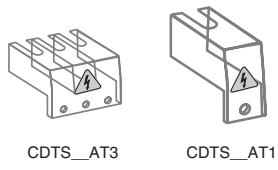

CDTS_AT3 CDTS_AT1



CDSA1 CDSA2



CDTL-ST

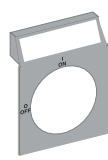

CDP_2

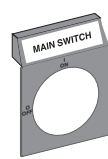

CDP_2EN1

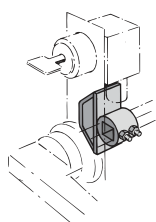

CDETL-ZW16



NDNA100
NDNA200

Terminal shrouds* — snap on mounting for line or load side

Description	For use on:	Weight (lbs.)	Catalog number
3 pole includes one shroud for line or load side	CDNF16, -25, -32 A3	0.02	CDTS32AT3 CDTS63AT3 CDTS100T3
	CDNF45, -63 A3	0.02	
	CDNF30, -60, -100 A3	0.02	
4th pole includes one shroud for line or load side	CD_32PP	0.02	CDTS32AT1 CDTS63AT1 CDTS100T1
	CD_63PP	0.02	
	CD_125PP	0.02	

* All disconnects are IP20 touch safe as standard. Terminal shrouds provide an additional level of protection.

Padlocking adapter

Description	For use on:	Weight (lbs.)	Catalog number
Adapter for one padlock with a max. 0.137" shackle	CDNF30, -45 A3	0.02	CDSA1
	CDNF60, -63 A3 CDNF - 100 A3		
Padlock for DS-SA1		0.22	CDSA2
Adapter and padlock		0.24	CDSA3

Labelling accessories

Description	For use on:	Package quantity	Catalog number
1 Pkg. of label carriers	CDNF30, -45 A3 CDNF60, -63 A3 CDNF - 100 A3	100 pieces	CDTL-ST
1 Pkg of blank description labels		315 pieces	CDT-E

Legend plates for selector handles

Description	For use on:	Catalog number
Blank plate	Black	CBDH1S, CBDH15S
	Yellow	CBDH2S, CBDH16S
	Black	CBDH3S, CBDH5S
	Yellow	CBDH4S, CBDH6S
Plate marked with: MAIN SWITCH	Black	CBDH1S, CBDH15S
	Yellow	CBDH2S, CBDH16S
	Black	CBDH3S, CBDH5S
	Yellow	CBDH4S, CBDH6S

Locking accessories

Description	For use on:	Weight (lbs.)	Catalog number
Cam attachment for Kirk Key, Castell, Lowe & Fletcher and Ronis interlock. For adapting to the interlock system. The interlock is not included.	6 & 8mm shafts	0.29	CDETL-ZW16

DIN rail

Description	For use on:	Weight (lbs.)	Length inches/mm	Catalog number
35mm DIN Rail	CDNF16 – CDFN100 A3	0.38	39.4/1000	NDNA100
35mm Aluminum DIN Rail	CDNF16 – CDFN100 A3	0.75	78.8/1000	NDNA200

Shaft support

Description	For use on:	Weight (lbs.)	Catalog number
Shaft support	CDNF16 – CDFN100 A3	0.30	CDTL-ZX58

Accessories for 16A – 100A Non-Fusible Disconnect Switches

COOPER Bussmann
Base & DIN Rail Mounted

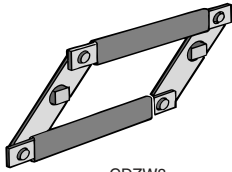

CDZW8



BDZW1

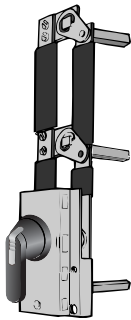

CDZW17

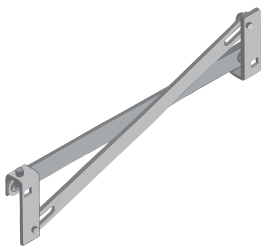

CDZW24

Conversion mechanisms

- For use with Base and DIN rail mounted switches only
- Switches are not included

Description	For use on:	Weight (lbs.)	Catalog number
6 or 8 pole	CDNF16 – CDNF100A3	0.33	CDZW8
Transfer		1.87	BDZW1
Bypass		1.54	CDZW17

6 or 8 pole — CDZW8

6 (8) pole mechanism allows two switches controlled by one handle to open or close simultaneously.

Equipment required for a complete installation:

- One conversion mechanism
- Two disconnect switches
- One handle^①
- One 5mm shaft

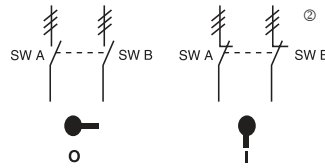

	POS. O	POS. I
SW. A	O	X
SW. B	O	X

X = Closed
O = Open

Transfer — BDZW1

Transfer mechanism manually transfers between two power sources using two switches and a center OFF position. A 3-position handle is included:

(UL Type 1, 3R & 12) or
(UL Type 1, 3R, 4, 4X, 12)

Shafts included. Equipment required for a complete installation:

- One conversion mechanism
- Two disconnect switches

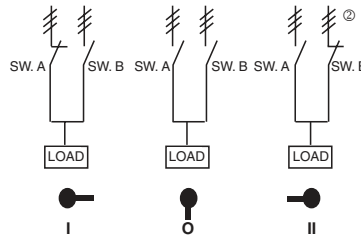

	POS. I	POS. O	POS. II
SW. A	X	O	O
SW. B	O	O	X

X = Closed
O = Open

Bypass — CDZW17

Bypass mechanism operates three switches: Two switches in series and one changeover switch to allow power bypass.

A 3-position handle is included:
(UL Type 1, 3R & 12) or
(UL Type 1, 3R, 4, 4X, 12) Shafts included.

Equipment required for a complete installation:

- One conversion mechanism
- Three disconnect switches

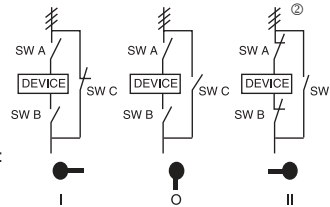

	POS. I	POS. O	POS. II
SW. A	O	O	X
SW. B	O	O	X
SW. C	X	O	O

X = Closed
O = Open

Mechanical interlock — CDZW24

Mechanical interlock mechanism prevents both switches from being in the ON position at the same time.

Equipment required for a complete installation:

- One conversion mechanism
- Two disconnect switches
- Two handles
- Two shafts

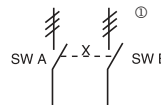

	SW. A POS. I	SW. B POS. I
SW. A	X	O
SW. B	O	X

X = Closed
O = Open

① CDNF16 – CDNF32A3 can use a selector or pistol handle. All other sizes must use a pistol handle.

② ≡ = Three poles

Fusible

Non-Fused

Enclosed Fused

Enclosed Non-Fused

Door Mounted

For a complete assembly,
please order one of each:

- 1 switch
- 1 handle



CDNF45A3D



CDH9S

16 – 100 Amp switches, 600V, 3 pole^{①②③}

UL general purpose amp rating	IEC AC21 amp rating	Maximum horsepower rating						Terminal lugs		Catalog number
		Single phase		Three phase				Wire size	Wire type	
		120V	240V	200V	240V	480V	600V			
16	16	1/2	1.5	3	5	10	10	#18 – 8	Cu	CDNF16A3D
25	25	3/4	2	7.5	7.5	15	20	#18 – 8	Cu	CDNF25A3D
40	40	1	3	10	10	20	25	#18 – 8	Cu	CDNF32A3D
60 ^④	63	2	5	15	15	30	20	#14 – 4	Cu	CDNF45A3D
80 ^④	80	2	5	20	20	40	40	#14 – 1	Cu	CDNF63A3D
30 ^④	40	2	5	10	10	20	30	#14 – 4	Cu	CDNF30A3D
60 ^④	63	3	7.5	20	20	40	40	#14 – 4	Cu	CDNF60A3D
100 ^④	115	5	15	25	25	50	40	#8 – 1/0	Cu	CDNF100A3D

Selector handles

NEMA/UL type	IEC type	Color	Defeatable	Padlockable	Weight (lbs)	Catalog number
-----------------	-------------	-------	------------	-------------	-----------------	-------------------

All marked both O/I & Off/On

Snap-on mounting — for use on CDNF16, 25, 32A3D

Quantity	IP Rating	Color	Defeatable	Padlockable	Weight (lbs)	Catalog number
1	IP54	Black	—	—	0.10	CBDH7S
1	IP54	Red/Yel	—	—	0.10	CBDH8S
1	IP54	Black	—	Yes	0.13	CBDH19S
1	IP54	Red/Yel	—	Yes	0.13	CBDH20S
1,3R,12	IP65	Black	—	Yes	0.17	CBDH9S
1,3R,12	IP65	Red/Yel	—	Yes	0.17	CBDH10S

Screw mounting — for use on CDNF16, 25, 32, 45 & 63A3D

Quantity	IP Rating	Color	Defeatable	Padlockable	Weight (lbs)	Catalog number
1	IP54	Black	—	—	0.11	CBDH11S
1	IP54	Red/Yel	—	—	0.11	CBDH12S
1	IP54	Black	—	Yes	0.14	CBDH17S
1	IP54	Red/Yel	—	Yes	0.14	CBDH18S
1,3R,12	IP65	Black	—	Yes	0.18	CBDH13S
1,3R,12	IP65	Red/Yel	—	Yes	0.18	CBDH14S

Door mounted switches do not provide door interlock

Pistol grip handle adapter

Description	For use on:	Weight (lbs)	Catalog number
Adapter piece for pistol grip handle (Note: derates handle to NEMA 1)	CDNF30, CDNF60, CDNF100S	0.18	CDHZSX6

- ① A snap on fourth pole may be added
- ② Door mounted switches do not require shafts.
- ③ CDNF16, 25, 32, 45 & 63 door mounted switches will not accept pistol handles.
- ④ CDNF45 & 63 door mounted switches can only use screw mounted handles.



CDNF16A3D
CDNF25A3D
CDNF32A3D



CDBH8S
CDBH12S



CDBH17S
CDBH19S



CDBH9S
CDBH13S



CDBH10S
CDBH14S

Fusible

Non-Fused

Enclosed Fused

Enclosed Non-Fused

Accessories for 16A – 100A Non-Fusible Disconnect Switches



Door Mounted

Door mounted switches

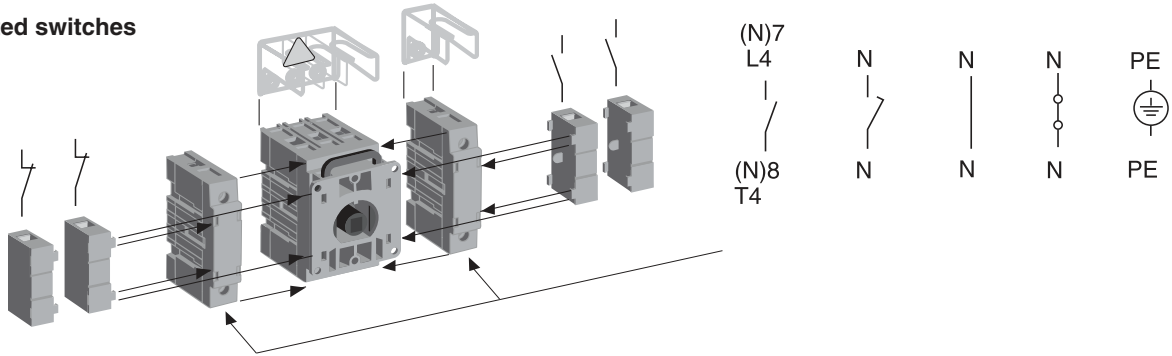

Fusible

Non-Fused

Enclosed Fused

Enclosed Non-Fused

Auxiliary contacts^① — snap-on mounting

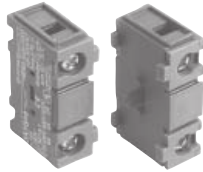

CDAUX_

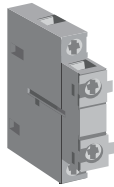

CDAUX11

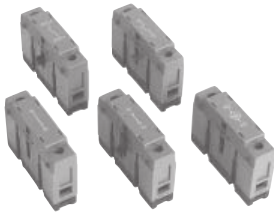

CD_32A3D



CD_63A3D

Description	For use on:	Weight (lbs)	AC thermal amp rating	AC rated voltage	Catalog number
1 N.O. mounts on righthand side of switch	CDNF16A3D - CDNF100A3D	0.07	10	600	CDAUX10
1 N.C. mounts on lefthand side of switch		0.07	10	600	CDAUX01
1 N.O. + 1 N.C. mounts on left or right hand side of switch		0.07	10	600	CDAUX11

Max. two contacts on each side of switch

Power poles

- Only one power pole per switch
- Mounts on left or right side of switch

Description	For use on:	Weight (lbs)	AC thermal amp rating	AC rated voltage	Catalog number
Fourth pole ^②	CDNF16A3D, -25A3D, -32A3D	0.07	40	600	CDS32PD
	CDNF30A3D, -60A3D	0.13	60	600	CDS60PD
	CDNF45A3D, -63A3D	0.13	80	600	CDS63PD
	CNDF100A3D	0.20	100	600	CDS100PD
Late-break/early-make ^②	CDNF16A3D, -25A3D, -32A3D	0.07	40	600	CDL32PD
	CDNF45A3D, -63A3D	0.13	80	600	CDL63PD
	CDNF30A3D, -60A3D, -100A3D	0.20	100	600	CDL100PD

Terminal poles

- Switch accepts one terminal pole per side
- Mounts on left or right side of switch

Description	For use on:	Weight (lbs)	AC thermal amp rating	AC rated voltage	Catalog number
Solid neutral ^②	CDNF16A3D, -25A3D, -32A3D	0.07	40	600	CDN32PD
	CDNF30A3D, -60A3D	0.17	60	600	CDN60PD
	CDNF45A3D, -63A3D	0.13	80	600	CDN63PD
	CNDF100A3D	0.20	100	600	CDN100PD
Ground terminal ^②	CDNF16A3D, -25A3D, -32A3D	0.07	40	600	CDE32PD
	CDNF30A3D, -60A3D	0.13	60	600	CDE32PD
	CDNF45A3D, -63A3D	0.13	80	600	CDE63PD
	CNDF100A3D	0.20	100	600	CDE100PD

^① UL File # E83510

^② Switch accepts one power pole or one terminal pole per side. Only one power pole per switch.

Door Mounted

Terminal shrouds* — snap-on mounting for line or load side

Description	For use on:	Weight (lbs)	Catalog number
3 pole includes one shroud for line or load side	CDNF16D, 25D, 32D	0.02	CDTS32AT3 CDTS63AT3 CDTS100T3
	CDNF45D & 63D	0.02	
	CDNF30D, 60D, 100D	0.02	
4 pole includes one shroud for line or load side	CD_32D	0.02	CDTS32AT1 CDTS63AT1 CDTS100T1
	CD_63D	0.02	
	CD_100D	0.02	

* All disconnects are IP20 touch safe as standard. Terminal shrouds provide an additional level of protection.

Legend plates for selector handles

Description	For use on:	Catalog number
Blank plate		
Black	CBDH1S, CBDH15S	CDPB1
Yellow	CBDH2S, CBDH16S	CDPY1
Black	CBDH3S, CBDH5S	CDPB2
Yellow	CBDH4S, CBDH6S	CDPY2
Plate marked with: MAIN SWITCH		
Black	CBDH1S, CBDH15S	CDPB1EN1
Yellow	CBDH2S, CBDH16S	CDPY1EN1
Black	CBDH3S, CBDH5S	CDPB2EN1
Yellow	CBDH4S, CBDH6S	CDPY2EN1

Locking clip (replacement part)

Description	For use on:	Catalog number
Door mounted switch handle locking clip	CDNF16DA3D CDNF25DA3D CDNF32DA3D	CDBY68140

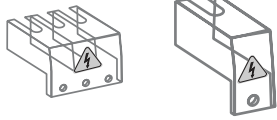

CDTS_AT3

CDTS_AT1

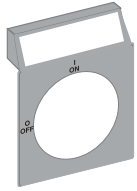

CDP_

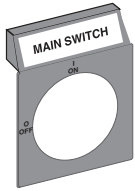

CPP_EN1



CDBY68140

Fusible

Non-Fused

Enclosed Fused

Enclosed Non-Fused

For a complete assembly, please select one of each:

- 1 switch
- 1 handle
- 1 shaft

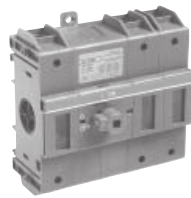

CDNF160



BDS210



BDH60

125 Amp Base & DIN rail mounted switches^①, 600V

UL 98 general purpose amp rating	IEC AC21 amp rating	Maximum horsepower rating					Terminal lugs		Catalog number
		Three phase					Wire size	Wire type	
		200V	208V	240V	480V	600V			
2 pole									
100	160	—	—	—	—	—	#8 – 1/0	Cu	CDNF160-2
3 pole									
100	160	30	30	30	60	75	#8 – 1/0	Cu	CDNF160

125 Amp Door mounted switch^①, 600V, 3 pole

UL 98 general purpose amp rating	IEC AC21 amp rating	Maximum horsepower rating					Terminal lugs		Catalog number
		Three phase					Wire size	Wire type	
		200V	208V	240V	480V	600V			
100	160	30	30	30	60	75	#8 – 1/0	Cu	CDNF160D

Pistol handles — for use with $\square .24 \times .24''$ ($\square 6 \times 6 \text{ mm}$)

NEMA type	IEC type	Color	Length in/mm	Marking	Defeat-able	Padlock-able	Weight (lbs)	Catalog number
1, 3R, 12	IP65	Black	2.6/65	O/I & Off/On	Yes	Yes	0.29	BDH58
1, 3R, 12	IP65	Red/Yel	2.6/65	O/I & Off/On	Yes	Yes	0.29	BDH59
1, 3R, 12	IP65	Black	3.1/80	O/I & Off/On	Yes	Yes	0.30	BDH60
1, 3R, 12	IP65	Red/Yel	3.1/80	O/I & Off/On	Yes	Yes	0.30	BDH61
1, 3R, 4, 4X, 12	IP66	Black	3.1/80	O/I & Off/On	Yes	Yes	0.30	CDHXB86
1, 3R, 4, 4X, 12	IP66	Red/Yel	3.1/80	O/I & Off/On	Yes	Yes	0.30	CDHXY86

Shafts — for use with pistol handles $\square .24 \times .24''$ ($\square 6 \times 6 \text{ mm}$)

Shaft length inches/mm		Mounting depth ^② in inches	Weight (lbs)	Catalog number
5.2/130		4.3 – 6.0	0.08	BDS130
5.9/150		5.0 – 6.7	0.09	BDS150
8.3/210		7.4 – 9.1	0.13	BDS210
11.4/290		10.5 – 12.2	0.18	BDS290
14.2/360		13.3 – 15.0	0.23	BDS360
16.9/430		16.0 – 17.8	0.27	BDS430

Twisted shafts — Rotates handle 45° $\square .24 \times .24''$ ($\square 6 \times 6 \text{ mm}$)

Shaft length inches/mm		Mounting depth ^② in inches	Weight (lbs)	Catalog number
5.2/130		4.3 – 6.0	0.08	BDST4
8.3/210		7.4 – 9.1	0.13	BDST25
11.4/290		10.5 – 12.2	0.18	BDST29
14.2/360		13.3 – 15.0	0.23	BDST30

① A snap on fourth pole may be added

② Mounting depth is the distance from the outside of the door to the disconnect switch mounting plate. Shaft can be cut to desired length.

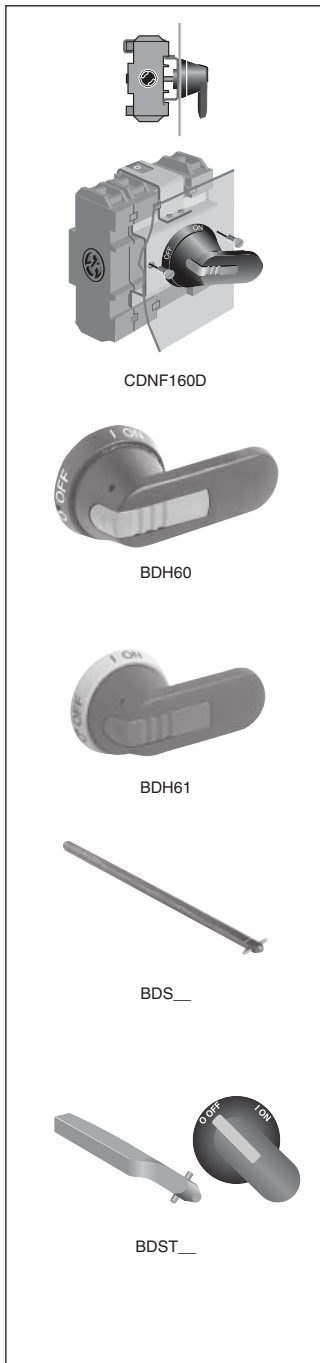

Fusible

Non-Fused

Enclosed Fused

Enclosed Non-Fused

Fusible

Non-Fused

Enclosed Fused

Enclosed Non-Fused

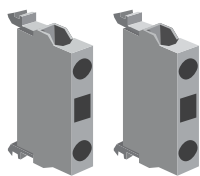

CDAUXCA10 CDAUXCA01

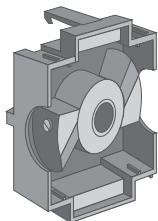

CDAUXB160



CDAUX16011 CDMB160

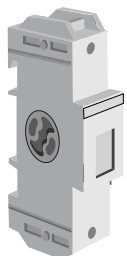

CD_160P

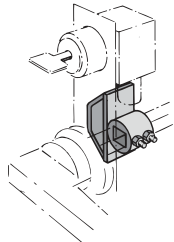

CDETL-ZW16

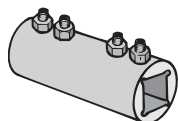

BDZX167
BDZX95

Auxiliary contacts, top mounted

- Accepts four contacts maximum, mounting base always required

Description	For use on:	Weight (lbs)	AC thermal amp rating	AC rated voltage	Catalog number
1 N.O.	CDNF160	0.07	10	600	CDAUXCA10
1 N.C.			10	600	CDAUXCA01
1 N.O. gold plated ^①	CDNF160	0.07	10	600	CDEA-10AU
1 N.C. gold plated ^①			10	600	CDEA-01AU
Mounting base – required for CDAUX_	CDAUX_	0.06	—	—	CDAUXB160

Auxiliary contacts, side mounted

- Accepts four contacts maximum

Description	For use on:	Weight (lbs)	AC thermal amp rating	AC rated voltage	Catalog number
1 N.O. & 1 N.C.	CDNF160	0.07	10	600	CDAUX16011
Mounting base, required for CDAUX16011	CDNF160	0.06	—	—	CDMB160

Max. two contacts on each side of switch. One mounting base required for each side of switch

Numbering stickers^②

Description	For use on:	Package qty.	Catalog number
1 Pkg. of blank labels for OBEA-10, 1 N.O.	CDNF160	10	CDEA-ZX10
1 Pkg. of blank labels for OBEA-01, 1 N.C.	CDNF160	10	CDEA-ZX01

Power pole — for use with base or door mounted switch

- Only one power pole per switch
- Mounts on left or right side of switch

Description	For use on:	Weight (lbs)	AC thermal amp rating	AC rated voltage	Catalog number
Fourth pole	CDNF160	0.66	125	600	CDS160P

Terminal poles — for use with base or door mounted switch

- Switch accepts one terminal pole per side
- Mounts on left or right side of switch

Description	For use on:	Weight (lbs)	AC thermal amp rating	AC rated voltage	Catalog number
Detachable solid neutral mounts on side of switch or DIN rail	CDNF160	0.66	125	600	CDN160P
Ground terminal	CDNF160	0.66	125	600	CDE160P

Locking accessories

Description	For use on:	Weight (lbs)	Catalog number
Cam attachment for Kirk Key, Castell, Lowe & Fletcher and Ronis interlock. For adapting to the interlock system. The interlock is not included.	5, 6 & 8mm shafts	0.29	CDETL-ZW16

Handle support bracket

Description	For use on:	Weight (lbs)	Catalog number
Allows pistol handle to be directly mounted to switch behind the door	CDNF160	0.33	CDZX5

Shaft extension couplers

Description	For use on:	Weight (lbs)	Catalog number
Joins two shafts together for applications where extended length is required	for 6mm shafts	0.26	BDZX167 BDZX95
	for 12mm shafts	0.26	

^① Type _AU for low energy applications. The contacts are gold-plated. AC & DC ratings — Maximum: A600 & P600. Minimum: 12V, 1mA; 5V, 2mA
^② Required if several contact blocks are used in the same installation.

Accessories for 125A Non-Fusible Disconnect Switches

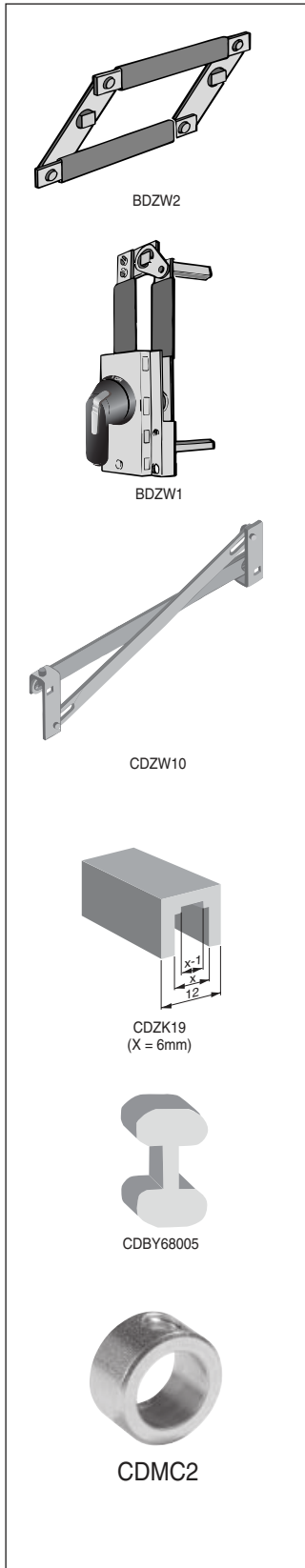

Conversion mechanisms

- For use with Base and Din rail mounted switches only
- Switches are not included

Description	For use on:	Weight (lbs.)	Catalog number
6 or 8 pole	CDNF160	1.52	BDZW2
Transfer (1, 3R, 12)		2.20	BDZW1
Transfer (4X)		2.20	BDZW1X
Mechanical interlock		0.55	CDZW10

6 or 8 pole — BDZW2

6 (8) pole mechanism allows two switches controlled by one handle, to open or close simultaneously. Shafts included.

Equipment required for a complete installation:

- One conversion mechanism
- Two disconnect switches
- One handle

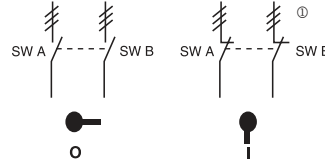

	POS. O	POS. I
SW. A	O	X
SW. B	O	X

X = Closed
O = Open

Transfer — BDZW1

Transfer mechanism manually transfers between two power sources using two switches and a center OFF position. A 3 position handle is included. (UL Type 1, 3R & 12) or (UL Type 1, 3R, 4, 4X, 12) Shafts included. Equipment required for a complete installation:

- One conversion mechanism
- Two disconnect switches

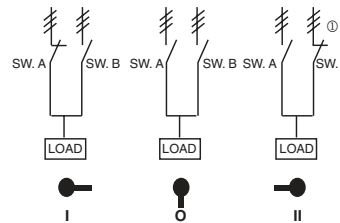

	POS. I	POS. O	POS. II
SW. A	X	O	O
SW. B	O	O	X

X = Closed
O = Open

Mechanical interlock — CDZW10

Mechanical interlock mechanism prevents both switches from being in the ON position at the same time.

Equipment required for a complete installation:

- One conversion mechanism
- Two disconnect switches
- Two handles
- Two shafts



	SW. A POS. I	SW. B POS. I
SW. A	X	O
SW. B	O	X

X = Closed
O = Open

Shaft adapter

Description	For use on:	Weight (lbs)	Catalog number
Adapts one end of a 5 or 6mm shaft to 12mm Use with shaft extension coupler	5 & 6mm shafts	0.20	CDZK19

Power pole interlock (replacement part)

Description	For use on:	Weight (lbs)	Catalog number
Interlocks a power pole with an adjacent power pole	CDNF160	0.05	CDBY68005

Replacement collar (optional replacement for knob)

Description	For use on:	Weight (lbs)	Catalog number
Red knob (like original) for locking shaft in place ** re-use original set screw **	CDNF160	0.05	CXBY68100
Replaces original red knob for locking shaft in place ** re-use original set screw **	CDNF160	0.05	CDMC2

① ≡ = Three poles

Fusible

Non-Fused

Enclosed Fused

Enclosed Non-Fused

For a complete assembly, please select one of each:

- 1 switch
- 1 handle
- 1 shaft
- 1 terminal lug kit

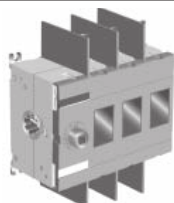

CDNF200U03



BDS210



BDH60

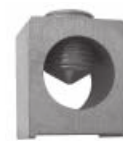

CDTL200

Non-Fusible 3 pole and 4 pole 200A Switch

200 AMP, 600V

UL general purpose amp rating	IEC AC21 Amp Rating	Maximum horsepower rating					Catalog number
		Three phase					
		200V	208V	240V	480V	600V	
3 pole							
200	250	60	60	75	250	200	CDNF200U03
4 pole							
200	250	60	60	75	250	200	CDNF200U04

Pistol handles - .24 x .24" (6 x 6mm)

UL/NEMA type	IEC type	Color	Length inches/mm	Marking	Defeatable	Padlockable	Weight (lbs)	Catalog number
1,3R,12	IP65	Black	3.1/80	O/I & Off/On	Yes	Yes	0.30	BDH60
1,3R,12	IP65	Red/Yel	3.1/80	O/I & Off/On	Yes	Yes	0.30	BDH61
1,3R,4,4X,12	IP65	Black	3.1/80	O/I & Off/On	Yes	Yes	0.30	CDHXB86
1,3R,4,4X,12	IP65	Red/Yel	3.1/80	O/I & Off/On	Yes	Yes	0.30	CDHXY86

Shafts - .24 x .24" (6 x 6mm)

Shaft length (inches/mm)	Mounting dept (inches)	Weight (lbs)	Catalog number
5.2/130	4.3-6.5	0.08	BDS130
5.9/150	5.0-7.2	0.09	BDS150
8.3/210	7.4-9.6	0.13	BDS210
11.4/290	10.5-12.7	0.18	BDS290
14.2/360	13.3-15.5	0.23	BDS360
16.9/430	16.0-18.2	0.27	BDS430

Twisted shafts - rotates handle 45° .24 x .24" (6 x 6mm)

Shaft length (inches/mm)	Mounting dept (inches)	Weight (lbs)	Catalog number
5.1/130	4.29-6.85	0.08	BDST4
8.3/210	7.44-10.0	0.13	BDST25
11.4/290	10.59-13.15	0.18	BDST29

Direct mount handle - TEST-OFF-ON

Description	Color	(lbs)	Catalog number
Up to 3 padlocks in OFF-position. Includes shaft and mechanism	Black	0.22	CDHTB20 CDHTY20
	Red/Yel	0.22	



BDH60, CDHXB86



BDH59, 61



BDS_

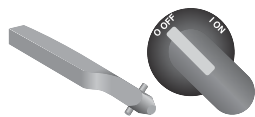

BDST_1

Fusible

Non-Fused

Enclosed Fused

Enclosed Non-Fused

Accessories for 200A Non-Fusible Disconnect Switches



CDTL200

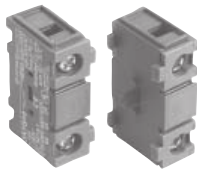

CDAUX10, CDAUX01K



CDTS250G1S/3



CDTS250G1L/3

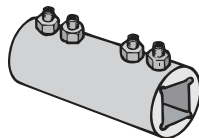

BDZX167, BDZW95

Terminal Lug Kits

For use on:	Wire Size	Wire Type	Description	Terminal lugs per kit	Weight (lbs)	Catalog number
CDNF200U03	#4-300kcmil		---	6	0.5	CDTL200
CDNF200U04	#4-300kcmil (6) 14-6 AWG	Cu/Al	Distribution lug	3	0.25	CDTL200/3P CDTL206

Auxiliary Contacts

Description	For use on:	Weight (lbs)	Catalog number
1 N.O. 1 N.C.	CDNF200U03 and CDNF200U04	0.07 0.07	CDAUX10 CDAUX01K

Module for auxiliary contacts

Description	Weight (lbs)	Catalog number
Screw mounting to the left side of the switch	0.1	CDAUXM28

Terminal shrouds

For use on:	Description	Number of poles	Weight (lbs)	Catalog number
CDNF200U03 and CDNF200U04	Long type	3	0.2	CDTS250G1L/3
	Short type	3	0.13	CDTS250G1S/3
	Long type	4	0.26	CDTS250G1L/4
	Short type	4	0.18	CDTS250G1S/4

Terminal poles

Description	Weight (lbs)	AC thermal amp rating	AC rated voltage	Catalog number
Mounting separately on base, plate protected construction	0.88	200	600	CDD200P

Shaft extension coupler

Description	For use on:	Weight (lbs)	Catalog number
Joins two shafts together for applications where extended length is required	6mm shafts 12mm shafts	0.26	BDZX167 BDZX95

Fusible

Non-Fused

Enclosed Fused

Enclosed Non-Fused

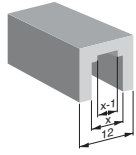

CDZK19
(X=6mm)



BDZW2

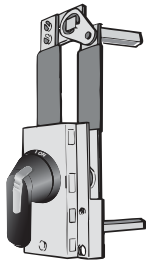

CDZW26

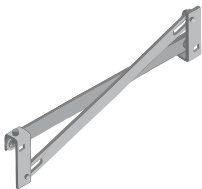

BDZW10

Shaft adapter

Description	For use on:	Catalog number
Adapts one end of a 6mm shaft to 12mm. Use with shaft extension coupler.	6mm shafts	CDZK19

Conversion mechanisms

Description	Weight (lbs)	UL/NEMA type	Catalog number
6 and 8 pole Mechanical interlock	1.52	-----	BDZW2
Transfer	0.55	-----	BDZW10
Bypass	6.17	1,3R,12	CDZW25
	7.28	1,3R,12	CDZW26

Fusible

Non-Fused

Enclosed Fused

Enclosed Non-Fused

400A

Non-Fusible Disconnect Switches



For a complete assembly,
please select one of each:

- 1 switch
- 1 handle
- 1 shaft
- 1 terminal lug kit

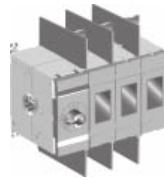

CDNF400U03



BDS280



BDH114

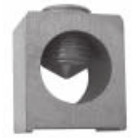

CDTL400

Non-Fusible 3 pole and 4 pole 400A Switch 200 AMP, 600V

UL general purpose amp rating	IEC AC21 Amp Rating	Maximum horsepower rating					Catalog number
		Three phase					
		200V	208V	240V	480V	600V	
3-pole							
400	630	100	100	125	250	350	CDNF400U03
4-pole							
400	630	100	100	125	250	350	CDNF400U04

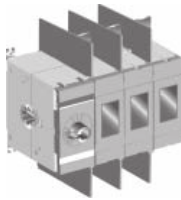

CDNF400U03



BDH112-117



BDS_



BDS_45



CDTL400

Pistol handles - $\square .47 \times .47''$ ($\square 12 \times 12\text{mm}$)

UL/NEMA type	IEC type	Color	Length inches/mm	Marking	Defeatable	Padlockable	Weight (lbs)	Catalog number
1,3R,12	IP65	Black	4.9/125	O/I & Off/On	Yes	Yes	0.39	BDH112
1,3R,12	IP65	Red/Yel	4.9/125	O/I & Off/On	Yes	Yes	0.39	BDH113
1,3R,12	IP65	Black	5.7/145	O/I & Off/On	Yes	Yes	0.39	BDH114
1,3R,12	IP65	Red/Yel	5.7/145	O/I & Off/On	Yes	Yes	0.39	BDH115
1,3R,12	IP65	Black	6.9/175	O/I & Off/On	Yes	Yes	0.41	BDH116
1,3R,12	IP65	Red/Yel	6.9/175	O/I & Off/On	Yes	Yes	0.41	BDH117
1,3R,4,4X,12	IP66	Black	5.7/145	O/I & Off/On	Yes	Yes	0.39	CDHXB12
1,3R,4,4X,12	IP66	Red/Yel	5.7/145	O/I & Off/On	Yes	Yes	0.39	CDHXY12
1,3R,4,4X,12	IP66	Black	6.9/175	O/I & Off/On	Yes	Yes	0.41	CDHXB22
1,3R,4,4X,12	IP66	Red/Yel	6.9/175	O/I & Off/On	Yes	Yes	0.41	CDHXY22
1,3R,4,4X,12	IP65	Metal	8.7/220	Off/On	---	Yes	1.50	BDHB

Shafts - $\square .47 \times .47''$ ($\square 12 \times 12\text{mm}$)

Shaft length (inches/mm)	Mounting dept (inches)	Weight (lbs)	Catalog number
11.0/280	10.2-14.5	0.77	BDS280
12.8/325	12.0-16.3	0.90	BDS325
15.6/395	14.8-19.1	1.10	BDS395
18.3/465	17.5-21.9	1.32	BDS465
21.1/535	20.3-24.6	1.54	BDS535

Twisted shafts - rotates handle 45° $\square .47 \times .47''$ ($\square 12 \times 12\text{mm}$)

Shaft length (inches/mm)	Mounting dept (inches)	Weight (lbs)	Catalog number
11.0/280	10.2-14.5	0.77	BDS28045
12.8/325	12.0-16.3	0.90	BDS32545
18.3/465	17.5-21.5	1.32	BDS46545

Direct mount handle - TEST-OFF-ON

Description	Color	(lbs)	Catalog number
Up to 3 padlocks in OFF-position. Includes shaft and mechanism	Black	0.44	CDHTB40 CDHTY40
	Red/Yel	0.44	

Fusible

Non-Fused

Enclosed Fused

Enclosed Non-Fused

Fusible

Non-Fused

Enclosed Fused

Enclosed Non-Fused

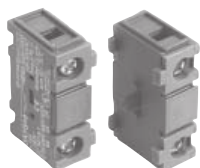

CDAUX10, CDAUX01k

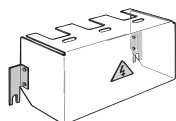

CDTS403

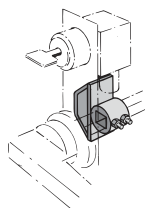

CDETL-ZW5

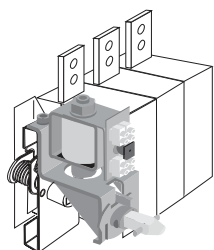

BDZW95

Terminal Lug Kits

For use on:	Wire Size	Wire Type	Description	Terminal lugs per kit	Weight (lbs)	Catalog number
CDNF400U03	#2-600kcmil		---	6	0.5	CDTL400
CDNF400U04	#2-600kcmil		---	3	0.5	CDTL400/3P
	(6) 14-6 AWG	Cu/Al	Distribution lug	3	0.5	CDTL406

Auxiliary Contacts

Mounting on the left side of the switch: Max. 8 auxiliary contact blocks with the CDAUXM28
 Mounting under the mechanism cover: Max. 4 auxiliary contact blocks

Description	For use on:	Weight (lbs)	Catalog number
1 N.O.	CDNF400U03, CDNF400U04	0.07	CDAUX10
1 N.C.		0.07	CDAUX01K

Module for auxiliary contacts

Description	Weight (lbs)	Catalog number
Screw mounting to the left side of the switch	0.1	CDAUXM28

Terminal shrouds

For use on:	Description	Number of poles	Weight (lbs)	Catalog number
CDNF400U03	3 pole			CDTS403
CDNF400U04				CONTACT FACTORY

Locking accessories

Description	For use on	Weight (lbs)	Catalog number
Cam attachment for Kirk Key, Castell, Lowe & Fletcher and Ronis interlock. Cam attachment for adapting to the interlock system. The interlock is not included.	12mm shafts	0.29	CDETL-ZW5

Shaft extension coupler

Description	For use on:	Weight (lbs)	Catalog number
Joins two shafts together for applications where extended length is required	12mm shafts	0.26	BDZW95

Accessories for 400A Non-Fusible Disconnect Switches

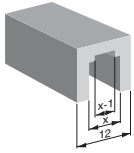

CDZK19
(x=6mm)



BDZW9

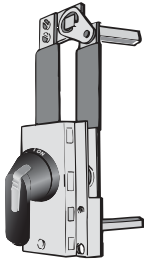

BDZW12

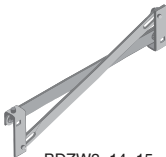

BDZW3, 14, 15

Shaft adapter

Description	For use on:	Catalog number
Adapts one end of a 6mm shaft to 12mm. Use with shaft extension coupler.	6mm shafts	CDZK19

Conversion mechanisms

Description	Weight (lbs)	Catalog number
6 and 8 pole Transfer Bypass	2.42	BDZW9
	10.1	BDZW12
	8.81	BDZW13
Mechanical Interlock	1.26	BDZW3
	1.15	BDZW14
	2.64	BDZW15

Fusible

Non-Fused

Enclosed Fused

Enclosed Non-Fused

For a complete assembly, please select one of each:

- 1 switch
- 1 handle
- 1 shaft
- 1 terminal lug kit



BDNF600A



BDS280



BDH116



BDTL26

Fusible

Non-Fused

Enclosed Fused

Enclosed Non-Fused



BDNF800A



BDH112-117



BDS280

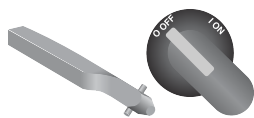

BDS_45

600 – 800 Amp switches, 600V

UL general purpose amp rating	IEC AC21 amp rating	Maximum horsepower rating					Catalog number
		200V	208V	240V	480V	600V	
2 pole							
600	800	—	—	—	—	—	BDNF600A2 BDNF800A2
800	1250	—	—	—	—	—	
3 pole							
600	800	150	150	200	400	500	BDNF600A BDNF800A
800	1250	200	200	250	500	600	
4 pole							
600	800	150	150	200	400	500	BDNF600A4 BDNF800A4
—	1250	200	200	250	500	600	

Pistol handles — for use with shafts $\square .47 \times .47"$ ($\square 12 \times 12$ mm)

NEMA type	IEC type	Color	Length in/mm	Marking	Defeatable	Padlockable	Weight (lbs)	Catalog number
1,3R,12	IP65	Blk	4.9/125	O/I & Off/On	Yes	Yes	0.39	BDH112
1,3R,12	IP65	R/Y	4.9/125	O/I & Off/On	Yes	Yes	0.39	BDH113
1,3R,12	IP65	Blk	5.7/145	O/I & Off/On	Yes	Yes	0.39	BDH114
1,3R,12	IP65	R/Y	5.7/145	O/I & Off/On	Yes	Yes	0.39	BDH115
1,3R,12	IP65	Blk	6.9/175	O/I & Off/On	Yes	Yes	0.41	BDH116
1,3R,12	IP65	R/Y	6.9/175	O/I & Off/On	Yes	Yes	0.41	BDH117
1,3R,4,4X,12	IP66	Blk	5.7/145	O/I & Off/On	Yes	Yes	0.39	CDHXB12
1,3R,4,4X,12	IP66	R/Y	5.7/145	O/I & Off/On	Yes	Yes	0.39	CDHXY12
1,3R,4,4X,12	IP66	Blk	6.9/175	O/I & Off/On	Yes	Yes	0.41	CDHXB22
1,3R,4,4X,12	IP66	R/Y	6.9/175	O/I & Off/On	Yes	Yes	0.41	CDHXY22
1,3R,4,4X,12	IP65	Metal	8.7/220	Off/On	—	Yes	1.50	BDH8

Shafts — for use with pistol handles $\square .47 \times .47"$ ($\square 12 \times 12$ mm)

Shaft length inches/mm	Mounting depth ^① in inches	Weight (lbs)	Catalog number
11.0/280	10.2 – 14.5	0.77	BDS280
12.8/325	12.0 – 16.3	0.90	BDS325
15.6/395	14.8 – 19.1	1.10	BDS395
18.3/465	17.5 – 21.9	1.32	BDS465
21.1/535	20.3 – 24.6	1.54	BDS535

Twisted shafts —rotates handle 45° $\square .47 \times .47"$ ($\square 12 \times 12$ mm)

Shaft length inches/mm	Mounting depth ^① in inches	Weight (lbs)	Catalog number
11.0/280	10.2 – 14.5	0.77	BDS28045
12.8/325	12.0 – 16.3	0.90	BDS32545
18.3/465	17.5 – 21.9	1.32	BDS46545

① Mounting depth is the distance from the outside of the door to the disconnect switch mounting plate. Shaft can be cut to desired length.

Accessories for 600A – 800A Non-Fusible Disconnect Switches

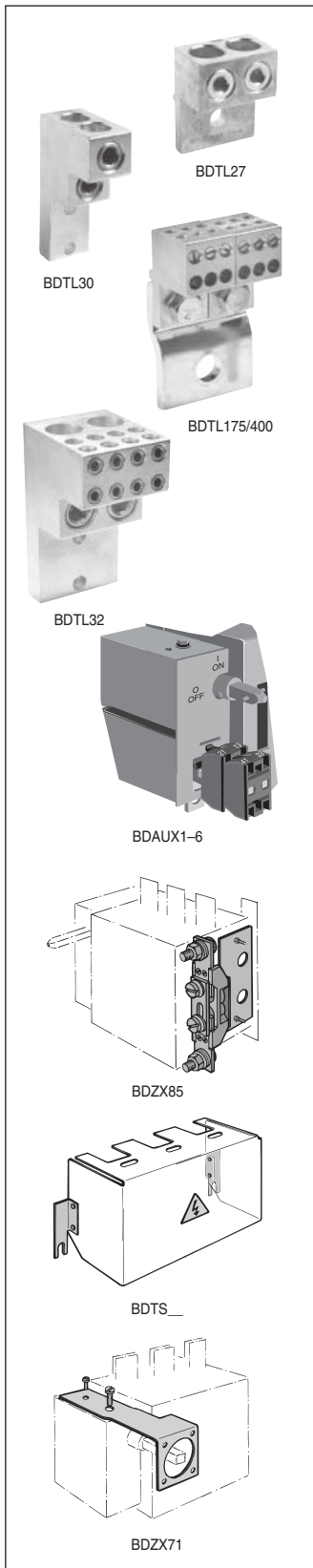

Terminal lug kits

For use on:	Wire size	Kit weight (lbs.)	Wire type	Terminal lugs per kit	Kit catalog number
BDNF600A	(2) #2 – 600 kcmil	4.62	Cu/Al	6	BDTL27
BDNF800A	(2) #2 – 600 kcmil	6.90	Cu/Al	6	BDTL30
BDNF800A ^①	(8) 2/0 + (2)#2 600 kcmil	6.90	Cu/Al	3	BDTL32
BDNF600A ^①	(12) #14 – 6	1.10	Cu/Al	6	BDTL175/400

Auxiliary contacts^②

Description	For use on:	Weight (lbs)	AC thermal amp rating	AC rated voltage	Catalog number
1 N.O. + 1 N.C.	BDNF600 – BDNF800A	0.20	10	600	BDAUX1
2 N.O. + 2 N.C.		0.26	10	600	BDAUX2
4 N.O. + 4 N.C.		0.40	10	600	BDAUX3
2 N.O.		0.18	10	600	BDAUX4
4 N.O.		0.25	10	600	BDAUX5
8 N.O.		0.40	10	600	BDAUX6

Terminal poles

Description	For use on:	Weight (lbs)	AC thermal amp rating	AC rated voltage	Catalog number
Detachable neutral mounts on side of switch or DIN rail	BDNF600A	1.04	400	600	BDZX85

Terminal shrouds

Description	For use on:	Weight (lbs)		Catalog number
Includes one shroud for line or load side	BDNF600A	0.62		BDTS4
	BDNF800A	0.66		BDTS6A
	BDNF800A	0.88		BDTS8A

Handle support bracket

Description	For use on:	Weight (lbs)		Catalog number
Allows handle to be directly mounted to switch behind the door	BDNF600A	0.51		BDZX73
	BDNF800A	0.88		BDZX71

^① A load side distribution lug eliminates the need to purchase, install and wire a separate distribution block.
^② UL File E57057

Fusible

Non-Fused

Enclosed Fused

Enclosed Non-Fused

Fusible

Non-Fused

Enclosed Fused

Enclosed Non-Fused

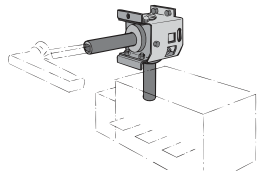

BDZX108

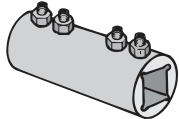

BDZW95

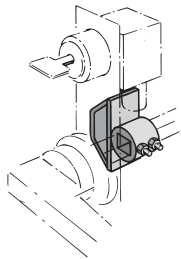

CDETL-ZW5

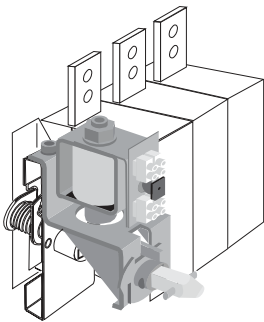

CDETL-ZT80_

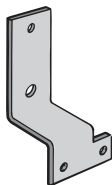

CDETL-ZT100

90° angle kit

Description	For use on:	Weight (lbs)	Catalog number
Converts switch mechanism from front operation to side operation	BDNF600A BDNF800A	4.63	BDZX108

Shaft extension coupler

Description	For use on:	Weight (lbs)	Catalog number
Joins two shafts together for applications where extended length is required	12mm shafts	0.26	BDZW95

Locking accessories

Description	For use on:	Weight (lbs)	Catalog number
Cam attachment for Kirk Key, Castell, Lowe & Fletcher and Ronis interlock. For adapting to the interlock system The interlock is not included.	12mm shafts	0.29	CDETL-ZW5
Electrical interlock ® Closed circuit principle for interlocking the switch movement. When the coil circuit is dead, A-types cannot be operated to ON-position and L-types cannot be operated to ON- or OFF-position. Coil voltages 110VAC, 220VAC, 24VDC, 48VDC, 60 VDC, 110VDC, 220VDC, P = 15W U = 0.7 – 1.1 Un (U = coil voltage, Un = nominal voltage)	BDNF600A BDNF800A	2.42	CDETL-ZT80A/* CDETL-ZT80L/*
Mounting bracket	BDNF600A	0.40	CDETL-ZT100

* – Coil voltage

® CDETL-ZT100 mounting bracket required for BDNF600A

Accessories for 600A – 800A Non-Fusible Disconnect Switches

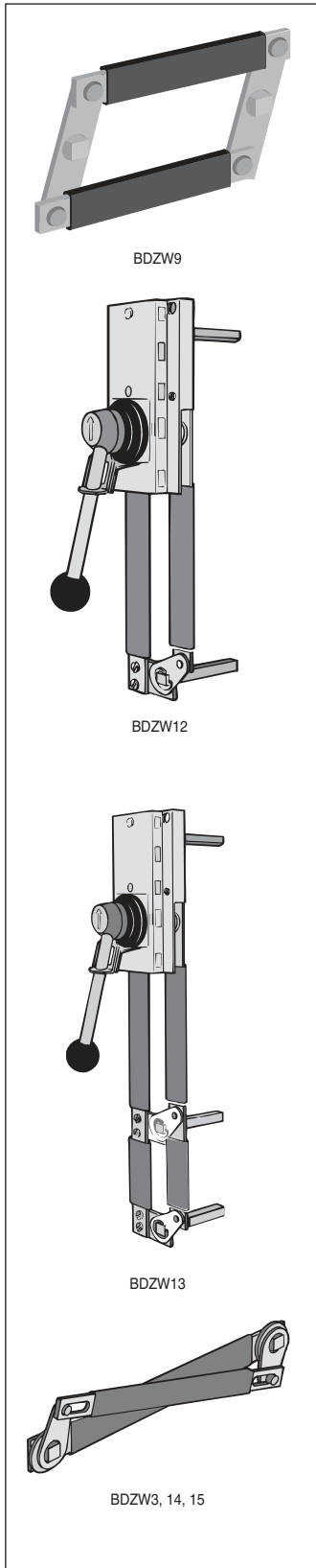

BDZW9

BDZW12

BDZW13

BDZW3, 14, 15

Conversion mechanisms

- Switches are not included

Description	For use on:	Weight (lbs)	Catalog number
6 or 8 pole Transfer Bypass	BDNF600A BDNF800A	2.42	BDZW9
		10.1	BDZW12
		8.81	BDZW13
Mechanical interlock		1.26	BDZW3
		1.15	BDZW14
		2.64	BDZW15

6 or 8 pole — BDZW9

6 (8) pole mechanism allows two switches controlled by one handle to open or close simultaneously. One shaft included.

Equipment required for a complete installation:

- One conversion mechanism
- Two disconnect switches
- One handle
- One additional shaft (Only one shaft is included with mechanism).

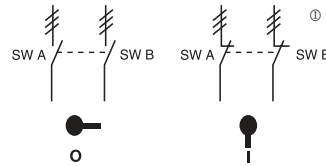

	POS.O	POS.I
SW. A	O	X
SW. B	O	X

X = Closed
O = Open

Transfer — BDZW12

Transfer mechanism manually transfers between two power sources using two switches and a center OFF position.

A 3 position handle is included.

Shafts included.

Equipment required for a complete installation:

- One conversion mechanism
- Two disconnect switches

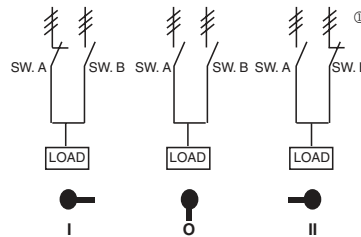

	POS. I	POS.O	POS.II
SW. A	X	O	O
SW. B	O	O	X

X = Closed
O = Open

Bypass — BDZW13

Bypass mechanism operates three switches: Two switches in series and one changeover switch to allow power bypass.

A 3 position handle is included. (UL Type 1, 3R, 4, 4X, 12). Shafts included.

Equipment required for a complete installation:

- One conversion mechanism
- Three disconnect switches

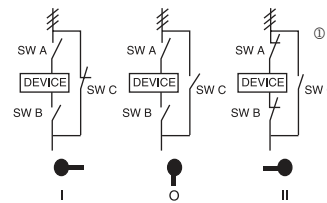

	POS. I	POS.O	POS.II
SW. A	O	O	X
SW. B	O	O	X
SW. C	X	O	O

X = Closed
O = Open

Mechanical interlock — BDZW3, BDZW14, BDZW15

Mechanical interlock mechanism prevents both switches from being in the ON position at the same time.

Equipment required for a complete installation:

- One conversion mechanism
- Two disconnect switches
- Two shafts
- Two handles

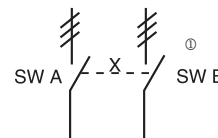

	SW. A POS. I	SW. B POS. I
SW. A	X	O
SW. B	O	X

X = Closed
O = Open

① ≡ = Three poles

Fusible

Non-Fused

Enclosed Fused

Enclosed Non-Fused

For a complete assembly please select one of each:

- 1 switch
- 1 handle
- 1 shaft
- 1 terminal lug kit



BDNF1200



BDS280



BDH117



BDTL28

1200 – 3150 Amp switches, 600V

UL general purpose amp rating	IEC AC21 amp rating	Maximum horsepower rating	Catalog number
2 pole		The US National Electric Code does not specify HP ratings for switches this large. Please select a switch based on 115% of application FLA. For example: a motor with an FLA of 800A would require a 1200A switch: 800A x 115% = 920A, the closest higher rated switch is 1200A.	BDNF12002 BDNF16002 BDNF20002 BDNF31502
1200	1600		
1600	2500		
2000	2500		
—	3150		BDNF1200 BDNF1600 BDNF2000 BDNF3150
3 pole			
1200	1600		
1600	2500		
2000	2500		
—	3150		BDNF12004 BDNF16004 BDNF20004 BDNF31504
4 pole			
—	1600		
—	2500		
—	2500		
—	3150		

Pistol handles — for use with shaft .47 x .47" (12 x 12mm)

NEMA type	IEC type	Color	Length mm	Marking	Defeatable	Padlockable	Weight (lbs)	Catalog number
For use with BDNF1200								
1,3R,12	IP65	Black	5.7/145	O/I & Off/On	Yes	Yes	0.39	BDH114
1,3R,12	IP65	Red/Yellow	5.7/145	O/I & Off/On	Yes	Yes	0.39	BDH115
1,3R,12	IP65	Black	6.9/175	O/I & Off/On	Yes	Yes	0.41	BDH116
1,3R,12	IP65	Red/Yellow	6.9/175	O/I & Off/On	Yes	Yes	0.41	BDH117
1,3R,4,4X,12	IP66	Black	5.7/145	O/I & Off/On	Yes	Yes	0.39	CDHXB12
1,3R,4,4X,12	IP66	Red/Yellow	5.7/145	O/I & Off/On	Yes	Yes	0.39	CDHXY12
1,3R,4,4X,12	IP66	Black	6.9/175	O/I & Off/On	Yes	Yes	0.41	CDHXB22
1,3R,4,4X,12	IP65	Red/Yellow	6.9/175	O/I & Off/On	Yes	Yes	0.41	CDHXY22

For use with BDNF1600 – 3150

1,3R,4,4X,12	IP65	Metal	8.7/220	Off/On	—	Yes	1.50	BDH8
--------------	------	-------	---------	--------	---	-----	------	------

Shafts — for use with pistol handles .47 x .47" (12 x 12 mm)

Shaft length inches/mm	Mounting depth [Ⓛ] in inches	Weight (lbs)	Catalog number
For use with BDNF1200			
11.0/280	11.6 – 15.3	0.77	BDS280
12.8/325	13.7 – 17.1	0.90	BDS325
15.6/397	16.2 – 19.9	1.10	BDS395
18.3/465	18.9 – 22.6	1.32	BDS465
21.1/536	21.7 – 25.4	1.54	BDS535
For use with BDNF1600 – 3150			
12.8/325	13.7 – 17.1	0.90	BDS325
15.6/397	16.2 – 19.9	1.10	BDS395
18.3/465	18.9 – 22.6	1.32	BDS465
21.1/536	21.7 – 25.4	1.54	BDS535

[Ⓛ] Mounting depth is the distance from the outside of the door to the disconnect switch mounting plate. Shaft can be cut to desired length.

Fusible

Non-Fused

Enclosed Fused

Enclosed Non-Fused

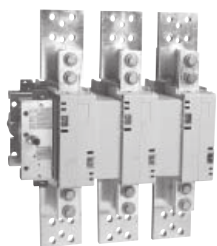

BDNF1600
BDNF2000
BDNF3150



BDH114



BDH115



BDH8



BDS325

Accessories for 1200A – 3150A Non-Fusible Disconnect Switches

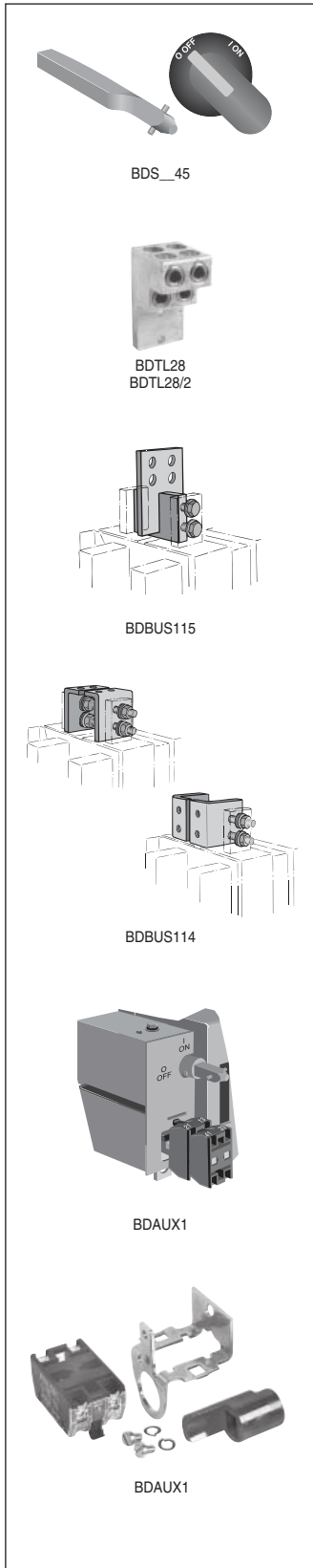

Twisted shafts – Rotates handle 45° □ .47 x .47" (□12 x 12 mm)

Shaft length inches/mm	Mounting depth ^① in inches	Weight (lbs)	Catalog number
For use with BDNF1200			
11.0/280	11.6 – 15.3	0.77	BDS28045
12.8/325	13.7 – 17.1	0.90	BDS32545
18.3/465	18.9 – 22.6	1.32	BDS46545
For use with BDNF1600 – 3150			
12.8/325	16.2 – 19.9	0.90	BDS32545
18.3/465	18.9 – 22.6	1.32	BDS46545

Terminal lug kits

For use on:	Wire size	Kit weight (lbs.)	Wire type	Terminal lugs per kit	Kit catalog number
BDNF1200 & BDNF1600	(4) #2 – 600kcmil	10.44	Cu/Al	6	BDTL28
BDNF1200 & BDNF1600 ^②	(8) 2/0 + (2) #2 600kcmil	10.44	Cu/Al	3	BDTL32
BDNF2000 & BDNF3150	(8) #2 – 600kcmil	20.88	Cu/Al	12	BDTL28/2

BDTL32 Power distribution lugs eliminate the need to purchase a separate distribution block

Busbar connections

Description	For use on:	Weight (lbs)	Catalog number
Vertical mounting ^③ Vertical, back or edgewise mounting	BDNF1600 –	46.2	BDBUS115
	BDNF3150	31.0	BDBUS114

Auxiliary contacts^④

Description	For use on:	Weight (lbs)	AC thermal amp rating	AC rated voltage	Catalog number
1 N.O. + 1 N.C.	BDNF1200 – BDNF3150	0.20	10	600	BDAUX1
2 N.O. + 2 N.C.		0.26	10	600	BDAUX2
4 N.O. + 4 N.C.		0.40	10	600	BDAUX3
2 N.O.		0.18	10	600	BDAUX4
4 N.O.		0.25	10	600	BDAUX5
8 N.O.		0.40	10	600	BDAUX6

Terminal shrouds

Description	For use on:	Weight (lbs)	Catalog number
Includes one shroud for line or load side	BDNF1200	1.20	BDTS12

① Mounting depth is the distance from the outside of the door to the disconnect switch mounting plate. Shaft can be cut to desired length.

② A load side distribution lug eliminates the need to purchase, install and wire a separate distribution block.

③ Provided as standard with BDNF1600, BDNF2000 and BDNF3150.

Fusible

Non-Fused

Enclosed Fused

Enclosed Non-Fused

Fusible

Non-Fused

Enclosed Fused

Enclosed Non-Fused

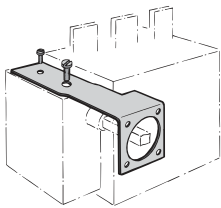

BDZX71

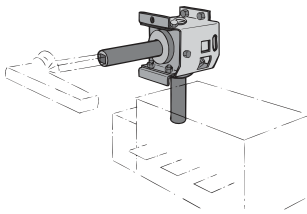

BDZX90

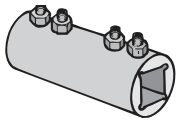

BDZW95

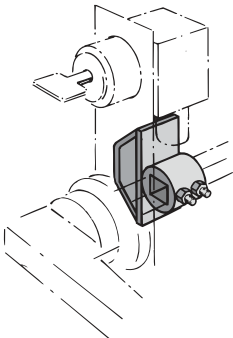

CDETL-ZW5

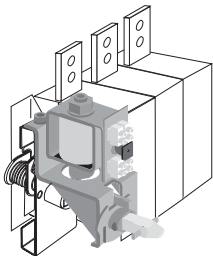

CDETL-ZT80

Handle support bracket

Description	For use on:	Weight (lbs)	Catalog number
Allows handle to be directly mounted to switch behind the door	BDNF1200 – BDNF3150	0.88	BDZX71

90° angle kit

Description	For use on:	Weight (lbs)	Catalog number
Converts switch mechanism from front operation to side operation	BDNF1200 – BDNF3150	4.63	BDZX90

Shaft extension coupler

Description	For use on:	Weight (lbs)	Catalog number
Joins two shafts together for applications where extended length is required	12mm shafts	0.26	BDZW95

Locking accessories

Description	For use on:	Weight (lbs)	Catalog number
Cam attachment for Kirk Key, Castell, Lowe & Fletcher and Ronis interlock. For adapting to the interlock system. The interlock is not included.	12mm shafts	0.29	CDETL-ZW5
Electrical interlock Closed circuit principle for interlocking the switch movement. When the coil circuit is dead, A-types cannot be operated to ON-position and L-types cannot be operated to ON- or OFF-position. Coil voltages 110VAC, 220VAC, 24VDC, 48VDC, 60 VDC, 110VDC, 220VDC, P = 15W U = 0.7 – 1.1 Un (U= coil voltage, Un = nominal voltage)	BDNF1200 – BDNF3150	2.42	CDETL-ZT80A* CDETL-ZT80L*



* = Coil voltage

Accessories for 1200A – 3150A Non-Fusible Disconnect Switches

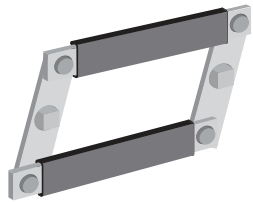

BDZW9

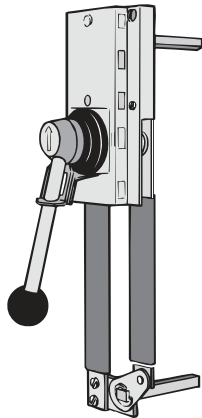

BDZW12

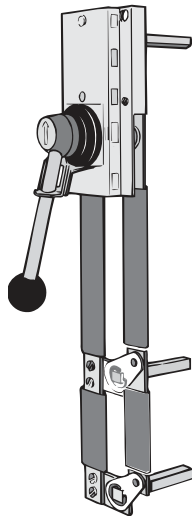

BDZW13

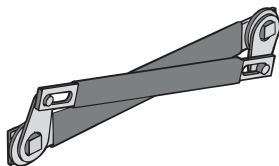

BDZW15

Conversion mechanisms

- Switches are not included

Description	For use on:	Weight (lbs)	Catalog number
6 or 8 pole Transfer Bypass	BDNF1200	2.42	BDZW9 BDZW12 BDZW13
		10.1	
		8.81	
Mechanical interlock	BDNF1200 – BDNF3150	2.64	BDZW15

6 or 8 pole — BDZW9

6 (8) pole mechanism allows two switches controlled by one handle to open or close simultaneously. One shaft included. Equipment required for a complete installation:

- One conversion mechanism.
- Two disconnect switches
- One handle
- One additional shaft (Only one shaft is included with mechanism)

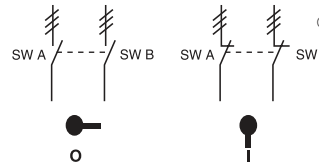

	POS. O	POS. I
SW. A	O	X
SW. B	O	X

X = Closed
O = Open

Transfer — BDZW12

Transfer mechanism manually transfers between two power sources using two switches and a center OFF position. A 3 position handle is included. Shafts included.

Equipment required for a complete installation:

- One conversion mechanism
- Two disconnect switches

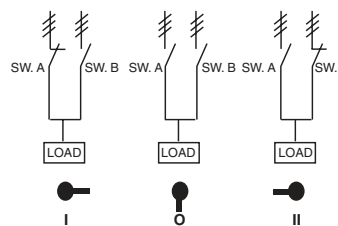

	POS. I	POS. O	POS. II
SW. A	X	O	O
SW. B	O	O	X

X = Closed
O = Open

Bypass — BDZW13

Bypass mechanism operates three switches: Two switches in series and one changeover switch to allow power bypass. A 3 position handle is included. Shafts included.

Equipment required for a complete installation:

- One conversion mechanism
- Three disconnect switches

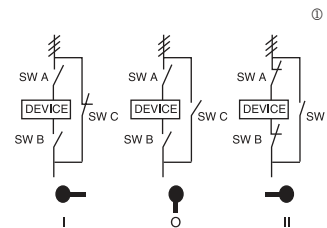

	POS. I	POS. O	POS. II
SW. A	O	O	X
SW. B	O	O	X
SW. C	X	O	O

X = Closed
O = Open

Mechanical interlock — BDZW15

Mechanical interlock mechanism prevents both switches from being in the "ON" position at the same time. Handles are not included.

Equipment required for a complete installation:

- One conversion mechanism
- Two disconnect switches
- Two shafts
- Two handles



	SW. A POS. I	SW. B POS. I
SW. A	X	O
SW. B	O	X

X = Closed
O = Open

① ≡ = Three poles

Fusible

Non-Fused

Enclosed Fused

Enclosed Non-Fused

For a complete assembly, please select one of each:

- 1 switch
- 1 handle
- 1 shaft
- 1 terminal lug kit

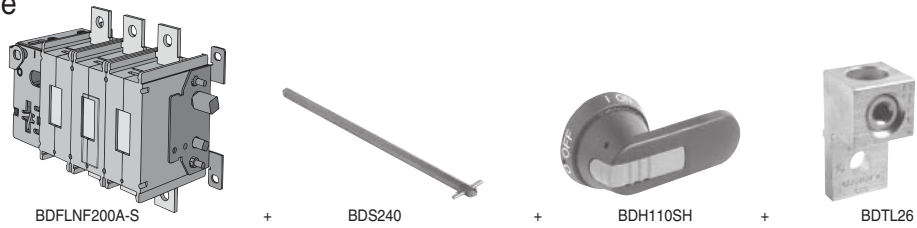

Fusible

Non-Fused

Enclosed Fused

Enclosed Non-Fused

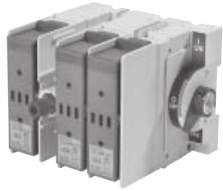

BDFLNF30-S



BDH107SH

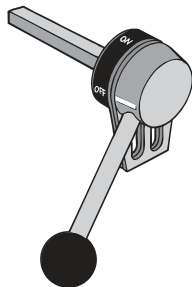

BDZX74



CDS67P
BDS240
BDS325



BDTL24



BDTL25



BDTL27

Side operated switches – 3 pole

UL general purpose amp rating	IEC AC21 amp rating	Maximum horsepower rating					Weight (lbs)	Catalog number
		Three phase						
		200V	208V	240V	480V	600V		
30	32	5	7.5	7.5	15	20	1.90	BDFLNF30-S
60	63	15	15	15	30	50	3.90	BDFLNF60-S
100	125	25	25	30	60	75	4.50	BDFLNF100-S
175	200	30	30	40	75	100	6.61	BDFLNF175-S
200	250	60	60	75	150	200	6.61	BDFLNF200A-S
400	630	100	100	125	250	350	13.66	BDFLNF400-S
600	800	150	150	200	400	500	13.66	BDFLNF600A-S

Handles

UL type	Color	Length inches/mm	Marking	Defeatable	Padlockable	Weight (lbs)	Catalog number
For use with BDFLNF30-S							
1, 12, 3R	Black	2.65/65	O/1 & Off/On	Yes	Yes	0.29	BDH106SH
1, 12, 3R	Red/Yellow	2.65/65	O/1 & Off/On	Yes	Yes	0.29	BDH107SH
For use with BDFLNF60-S – BDFLNF200A-S							
1, 12, 3R	Black	3.1/80	O/1 & Off/On	Yes	Yes	0.30	BDH110SH
1, 12, 3R	Red/Yellow	3.1/80	O/1 & Off/On	Yes	Yes	0.30	BDH111SH
For use with BDFLNF400-S – BDFLNF600A-S							
1, 12, 3R	Black	4.9/145	O/1 & Off/On	Yes	Yes	0.39	BDH114SH
1, 12, 3R	Red/Yellow	4.9/145	O/1 & Off/On	Yes	Yes	0.39	BDH115SH
1, 12, 3R	metal	4.9/145	Off/On	Yes	Yes	1.50	BDZX74

Shafts

For use with:	Length inches/mm	Description	Weight (lbs)	Catalog number
BDFLNF30-S	6.7/170	.20 x .20" (5 x 5mm)	0.08	CDS67P
BDFLNF60 – 100	8.3/210	.24 x .24" (6 x 6mm)	0.10	BDS210
BDFLNF175 – 200	9.5/240	.31 x .31" (8 x 8mm)	0.26	BDS240
BDFLNF400-S – 600A-S	12.8/325	.47 X .47" (12 X 12mm)	0.90	BDS325

Terminal lug kits

For use on:	Wire size	Weight (lbs)	Wire type	Lugs per kit	Catalog number
BDFLNF30-S	#14 – 4	—	Cu	—	Integral
BDFLNF60-S	#14 – 4	—	Cu	—	Integral
BDFLNF100-S	#14 – 2/0	0.43	Cu/Al	6	BDTL24
BDFLNF200A-S	#6 – 300 kcmil	0.93	Cu/Al	6	BDTL25
BDFLNF400-S	#2 – 600 kcmil	3.520	Cu/Al	6	BDTL26
BDFLNF600A-S	(2) #2 – 600 kcmil	4.62	Cu/Al	6	BDTL27

① Side operated switches available through 800A as IEC rated.

Flange Operated Non-Fusible Disconnect Switches 30A – 200A



For a complete assembly,
please select one of each:

- 1 switch
- 1 handle
- 1 shaft
- 1 terminal lug kit

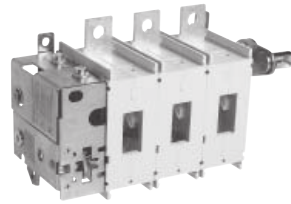

BDFLNF200A-F



BDFHS12

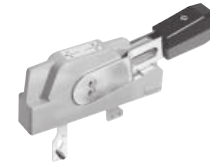

BDFHNS12



BDTL25

Flange operated switches – 3 pole

UL general purpose amp rating	IEC AC21 amp rating	Maximum horsepower rating					Weight (lbs)	Catalog number
		Three phase						
		200V	208V	240V	480V	600V		
30	40	10	10	10	20	30	2.80	BDFLNF30-F
60	63	20	20	20	40	40	3.90	BDFLNF60-F
100	115	25	25	25	50	40	4.50	BDFLNF100-F
200	250	60	60	75	150	200	6.61	BDFLNF200A-F

Flange handles

NEMA/UL type	Color	Length inches/mm	Marking	Defeatable	Padlockable	Weight (lbs)	Catalog number
1, 3R, 12	Metal	6.9/175	O/I & OFF/ON	Yes	Yes	3.52	BDFHNS12
4, 4X	Metal	6.9/175	O/I & OFF/ON	Yes	Yes	3.52	BDFHNS4

Shafts

Shaft length inches	Weight (lbs)	Catalog number
12	0.39	BDFHS12
17	0.55	BDFHS17
22.5	0.73	BDFHS22

Terminal lug kits

For use on:	Wire size	Kit weight (lbs)	Wire type	Terminal lugs per kit	Catalog number
BDFLNF30-F BDFLNF60-F BDFLNF100-F	#14 – #4	—	Cu	—	Standard BDTL24
BDFLNF200A-F	#6 – 300 kcmil	0.93	Cu/Al	6	BDTL25

Door hardware – NEMA 12

Description	Weight (lbs)	Catalog number
Safety door latch, 2 point with 6" handle.	1.92	BBDHK
Roller for 3 point latch, add to BDDHK	.39	BD3RL

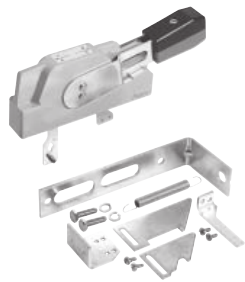

BDFHNS12



BDFHS12

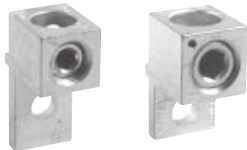

BDTL24

BDTL25

UL Listed
cULus Approved
IEC Rated
CE Marked

Fusible

Non-Fused

Enclosed Fused

Enclosed Non-Fused

For a complete assembly, please select one each of the following:



Switch

+



Handle

+



Cable

+

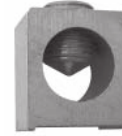

Lug kit (as required)

+



Operating mechanism



CDNF30A3



OHF1C12



BFCL36
BFCL84



Lug kit

Non-fusible

UL general purpose amp rating	Catalog Number
30	CDNF30A3
60	CDNF60A3
100	CDNF100A3
125	CDNF160
200	CDNF200U03

Flange handles - UL 98; File #E101914

For use with:	Environmental rating	Catalog number
CDNF30 - CDFN100, CDFN160, CDFN200	NEMA 1, 3R, 12	BDHFC12
	NEMA 4, 4X	BDHFC4

Flexible cables

For use with:	Cable length (inches)	Catalog number
CDNF30 - CDFN100, CDFN160, CDFN200	36	BFCL36
	48	BFCL48
	60	BFCL60
	72	BFCL72
	84	BFCL84

Operating mechanisms

For use with:	Catalog number
CDNF30 - 100	BMKCS1
CDNF160	BMKCS3
CDNF200	BMKCS4

Terminal lug kits

For use with:	Wire size	Wire type	Description	Lugs per kit	Catalog number
CDNF200U03	#4-300kcmil	Cu/Al	-	6	CDTL200
	#4-300kcmil	Cu/Al	-	3	CDTL200/3P
	(6)#4-6AWG	Cu/Al	Dist. lug	3	CDTL206

Door hardware — NEMA 12

Item	Catalog number
Safety door latch, 2 point, door less than 40" high	BKDH2R
Safety door latch, 3 point, door greater than 40" high	BKDH3R

Fusible

Non-Fused

Enclosed Fused

Enclosed Non-Fused

UL & cULus Technical Data for Non-Fusible Disconnect Switches



CDNF16 – CDFN160

UL & cULus

Catalog number	3 pole	CDNF16A3	CDNF25A3	CDNF32A3	CDNF45A3	CDNF63A3	CDNF30A3	CDNF60A3	CDNF100A3	CDNF160	
Approvals ^①	2 pole N/A 3 pole 4 pole	N/A UL508 & IEC UL508 & IEC	N/A UL508 & IEC UL508 & IEC	N/A UL508 & IEC UL508 & IEC	N/A UL508 & IEC UL508 & IEC	N/A UL508 & IEC UL508 & IEC	N/A UL508 & IEC UL508 & IEC	N/A UL98 & IEC UL98 & IEC	N/A UL98 & IEC UL98 & IEC	UL98 & IEC UL98 & IEC UL98 & IEC	
General purpose amp rating pf = 0.7 – 0.8	-40° to 40°C A	16	25	40	60	80	30	60	100	100	
Max. operating voltage	V	600	600	600	600	600	600	600	600	600	
Max. horsepower rating/motor FLA current, pf = 0.4 – 0.5											
Three phase	200V – 208V 240V 480V 600V	HP/A HP/A HP/A HP/A	3/10.6 5/15.2 10/14.0 10/11.0	7.5/24.2 7.5/22.0 15/21.0 20/22.0	10/30.8 10/28.0 20/27.0 25/27.0	15/46.2 15/42.0 30/40.0 30/32.0	20/60.0 20/54.0 40/52.0 40/41.0	10/30.8 10/28.0 20/27.0 30/32.0	20/60.0 20/54.0 40/52.0 40/41.0	25/75.0 30/80.0 50/65.0 50/52.0	30/88.0 30/80.0 60/77.0 75/77.0
Single phase	120V 240V	HP/A HP/A	0.5/9.8 1.5/10.0	0.75/13.8 2/12.0	1/16.0 3/17.0	2/24.0 5/28.0	2/24.0 5/28.0	2/24.0 5/28.0	3/34.0 7.5/40.0	5/56.0 15/68.0	7.5/80 20/88.0
Short circuit rating with fuse											
Fuse type CC	kA	10	10	10	100	100	50	50	50	100	
Fuse type J	kA	10	10	10	100	100	50	50	50	100	
Fuse type T	kA	10	10	10	100	100	50	50	50	100	
Fuse type RK1	kA	10	10	10	100	100	50	50	50	100	
Fuse type RK5	kA	5	5	5	5	10	5	5	5	5	
Fuse type L	kA	—	—	—	—	—	—	—	—	—	
Fuse type H	kA	—	—	—	—	5	5	—	—	—	
Fuse size	A	30	60	30	60	100	150	100	150	60	100
Short circuit rating with MCCB	kA	—	—	—	—	—	—	—	—	—	25
Endurances											
Min. Electrical endurance, pf = 0.75 – 0.80	operation cycles	6000	6000	6000	6000	6000	6000	6000	6000	6000	
Min. Electrical endurance, pf = 0.40 – 0.50	operation cycles	1000	1000	1000	1000	1000	②	②	②	②	
Mechanical endurance	operations	20,000	20,000	20,000	20,000	20,000	20,000	20,000	20,000	16,000	
Physical characteristics											
Weight, switches	3 pole 4 pole	lb	0.24 0.33	0.24 0.33	0.24 0.33	0.59 0.77	0.59 0.77	0.79 1.10	0.79 1.10	0.79 1.10	2.42 2.86
Dimension, switches	3 pole	H in W in D in	2.68 1.38 2.20	2.68 1.38 2.20	2.68 1.38 2.20	3.60 2.07 2.85	3.60 2.07 2.85	3.94 2.76 2.95	3.94 2.76 2.95	3.94 2.76 2.95	5.00 4.96 2.93
Shaft size — square □		in mm	.24 x .24 6 x 6	.24 x .24 6 x 6	.24 x .24 6 x 6	.24 x .24 6 x 6	.24 x .24 6 x 6	.24 x .24 6 x 6	.24 x .24 6 x 6	.24 x .24 6 x 6	.24 x .24 6 x 6
Switch operating torque for rotary 3 pole switches		lb. in.	8.8	8.8	8.8	10.5	10.5	17.5	17.5	17.5	52.5
Terminal lug kits			Not required	Not required	Not required	Not required	Not required	Not required	Not required	Not required	
Wire range	AWG	#18 – 8	#18 – 8	#18 – 8	#14 – 4	#14 – 1	#14 – 4	#14 – 4	#8 – 1/0	#8 – 1/0	
Torque:											
Wire tightening	lb. in.	7	7	7	18	18	55	55	55	70	
Lug mounting	lb. in.	Integral	Integral	Integral	Integral	Integral	Integral	Integral	Integral	Integral	
Auxiliary contacts		CDAUX_ _	CDAUX_ _	CDAUX_ _	CDAUX_ _	CDAUX_ _	CDAUX_ _	CDAUX_ _	CDAUX_ _	CDEA_ _ _ _	
NEMA ratings, AC		A600	A600	A600	A600	A600	A600	A600	A600	A600	
AC rated voltage	VAC	600	600	600	600	600	600	600	600	600	
AC thermal rated current	A	10	10	10	10	10	10	10	10	10	
AC maximum volt-ampere making	VA	7200	7200	7200	7200	7200	7200	7200	7200	7200	
AC maximum volt-ampere breaking	VA	720	720	720	720	720	720	720	720	720	
NEMA ratings, DC		R300	R300	R300	R300	R300	R300	R300	R300	P600	
DC rated voltage	VDC	300	300	300	300	300	300	300	300	600	
DC thermal rated current	A	1	1	1	1	1	1	1	1	5	
DC maximum make-break	VA	28	28	28	28	28	28	28	28	138	
Torque:											
Wire tightening	lb. in.	7	7	7	7	7	7	7	7	7	
Wire range	AWG	#18 – 14	#18 – 14	#18 – 14	#18 – 14	#18 – 14	#18 – 14	#18 – 14	#18 – 14	#22 – 14	

① UL Listed switches are also cULus Approved.
② UL 98 overload test, 50 operations, pf 0.40 – 0.50 at 2x FLA.

Fusible

Non-Fused

Enclosed Fused

Enclosed Non-Fused

CDNF200U03 – BDNF3150

UL & cULus

Catalog number			3 pole	CDNF200U03	CDNF400U03	BDNF600A	BDNF800A	BDNF1200	BDNF1600	BDNF2000	BDNF3150 ①
Approvals ^①	2 pole	UL98 & IEC 3 pole 4 pole	UL98 & IEC UL98 & IEC IEC	UL98 & IEC UL98 & IEC UL98 & IEC	UL98 & IEC UL98 & IEC UL98 & IEC	UL98 & IEC UL98 & IEC UL98 & IEC	UL98 & IEC UL98 & IEC UL98 & IEC	UL98 & IEC UL98 & IEC UL98 & IEC	UL98 & IEC UL98 & IEC UL98 & IEC	UL98 & IEC UL98 & IEC UL98 & IEC	UL98 & IEC UL98 & IEC UL98 & IEC
General purpose amp rating			-40° to 40°C								
pf = 0.7 – 0.8			A	200	400	600	800	1200	1600	2000	3150
Max. operating voltage			V	600	600	600	600	600	600	480	—
Max. horsepower rating/Max. motor FLA current, pf = 0.4 – 0.5											
Three phase	200 – 208V	HP/A	60/160.0	100/273.0	150/396.0	200/528.0	—	—	—	—	—
	240V	HP/A	75/192.0	125/312.0	200/480.0	250/602.0	—	—	—	—	—
	480V	HP/A	150/180.0	250/302.0	400/477.0	500/590.0	—	—	—	—	—
	600V	HP/A	200/192.0	350/336.0	500/472.0	600/576	—	—	—	—	—
	120V	HP/A	—	—	—	—	—	—	—	—	—
	240V	HP/A	—	—	—	—	—	—	—	—	—
Single phase											
Short circuit rating with fuse											
Fuse type CC			kA	—	—	—	—	—	—	—	—
Fuse type J			kA	100	100	—	—	—	—	—	—
Fuse type T			kA	—	—	—	—	—	—	—	—
Fuse type RK1			kA	—	—	—	—	—	—	—	—
Fuse type RK5			kA	—	—	—	100	—	—	—	—
Fuse type L			kA	—	—	—	—	100	100	100	100
Fuse type H			kA	—	—	—	—	—	—	—	—
Fuse size			A	350	600	600	1200	1200	2000	2000	—
Short circuit rating with MCCB			kA	15	30	50	50	50	65	65	—
Endurances											
Min. Electrical endurance, pf = 0.75 – 0.80			operation cycles	6000	1000	1000	500	500	500	500	400
Min. Electrical endurance, pf = 0.40 – 0.50			operation cycles	②	②	②	②	②	②	②	②
endurance			operations	20,000	20,000	10,000	10,000	10,000	6000	6000	6000
Physical characteristics											
Weight, switches	3 pole	lb	2.9	5.7	13.66	35.9	38.55	127.7	127.7	127.7	127.7
	4 pole	lb	3.5	6.8	16.74	45.15	49.56	149.7	149.7	149.7	149.7
Dimension, switches	3 pole	H in	6.69	8.66	11.77	19.09	19.09	25.04	25.04	25.04	25.04
		W in	6.67	8.70	11.93	14.29	14.29	18.43	18.43	18.43	18.43
		D in	3.30	4.15	5.12	4.92	4.92	10.67	10.67	10.67	10.67
		in	.24 x .24	.47 x .47	.47 x .47	.47 x .47	.47 x .47	.47 x .47	.47 x .47	.47 x .47	.47 x .47
Shaft size — square	□	mm	6 x 6	12 x 12	12 x 12	12 x 12	12 x 12	12 x 12	12 x 12	12 x 12	12 x 12
		lb. in.	62	142	184	184	184	438	438	438	438
Switch operating torque for rotary 3 pole switches											
Terminal lug kits				CDTL200	CDTL400	BDTL27	BDTL30	BDTL28	BDTL28	BDTL28/2	BDTL28/2
Wire range			AWG	#6-300kcmil ^③	#2-600kcmil	(2)#2-600kcmil	(2)#2-600kcmil	(4)#2-600kcmil	(4)#2-600kcmil	(8)#2-600kcmil	(8)#2-600kcmil
Torque:											
Wire tightening			lb. in.	275	375	375	500	375	375	375	375
Lug mounting			lb. in.	150	240	500	230	230	230	230	230
Auxiliary contacts				CDAUX_ _	CDAUX_ _	BDAUX_ _	BDAUX_ _	BDAUX_ _	BDAUX_ _	BDAUX_ _	BDAUX_ _
NEMA ratings, AC				A600	A600	A600	A600	A600	A600	A600	A600
AC rated voltage			VAC	600	600	600	600	600	600	600	600
AC thermal rated current			A	10	10	10	10	10	10	10	10
AC maximum volt-ampere making			VA	7200	7200	7200	7200	7200	7200	7200	7200
AC maximum volt-ampere breaking			VA	720	720	720	720	720	720	720	720
NEMA ratings, DC				P600	P600	P600	P600	P600	P600	P600	P600
DC rated voltage			VDC	600	600	600	600	600	600	600	600
DC thermal rated current			A	5	5	5	5	5	5	5	5
DC maximum make-break			VA	138	138	138	138	138	138	138	138
Torque:											
Wire tightening			lb. in	7	7	7	7	7	7	7	7
Wire range			AWG	#22 – #14	#22 – #14	#22 – #14	#22 – #14	#22 – #14	#22 – #14	#22 – #14	#22 – #14

① UL Listed switches are also cULus Approved.
 ② UL98 overload test, 50 operations, pf 0.40 – 0.50 at 2x FLA.
 ③ Multi-tap lug available.
 ④ IEC rated only.

IEC Technical Data for Non-Fusible Disconnect Switches



CDNF16 – CDNF160

IEC

Catalog number	3 pole	CDNF16	CDNF25	CDNF32	CDNF45	CDNF63	CDNF30	CDNF60	CDNF100	CDNF160
Rated insulation and operation voltage, AC20 and DC20 ^①	40°C V	750	750	750	750	750	750	750	750	12
Rated impulse withstand voltage	kV	8	8	8	8	8	8	8	8	12
Rated thermal current, I _m										
AC 20/DC 20										
open ^②	A	25	32	40	63	80	40	63	115	200
40°C enclosed	A	25	32	40	63	80	40	63	115	160
60°C enclosed	A	25	32	40	63	80	40	63	115	160
Rated operational currents										
AC 21A										
500V	A	16	25	32	63	80	40	63	100	160 ^③
690V	A	16	25	32	63	80	40	63	100	160 ^③
1000V ^④	A	—	—	—	—	—	—	—	—	—
AC 22A										
500V	A	16	25	32	63	80	40	63	100	160 ^③
690V	A	16	25	32	63	80	40	63	100	160 ^③
1000V ^④	A	—	—	—	—	—	—	—	—	—
AC 23A										
415V	A	16	20	23	45	75	40	63	80	135
500V	A	16	20	23	45	58	40	63	60	125
690V	A	10	11	12	20	20	40	40	40	80
1000V ^④	A	—	—	—	—	—	—	—	—	—
Rated operational currents/poles in series										
DC21A										
48V	A	16/1	25/1	32/1	45/1	63/1	40/1	63/1	100/1	160/1
110V	A	16/2	25/2	32/2	45/2	63/2	40/2	63/2	100/2	160/1
220V	A	16/3	25/3	32/3	45/4	63/4	40/4	63/4	100/4	160/2
440V	A	16/4	25/6	32/6	⑤	⑤	⑤	⑤	⑤	160/3
750V	A	16/8	25/8	32/8	⑤	⑤	⑤	⑤	⑤	160/4
DC22A										
48V	A	16/1	25/1	32/1	45/1	63/1	40/1	63/1	100/1	160/1
110V	A	16/2	25/2	32/2	45/2	63/2	40/2	63/2	100/2	160/1
220V	A	16/3	25/3	32/4	45/4	63/4	40/4	63/4	63/4	160/2
440V	A	16/6	25/8	⑥	⑥	⑥	⑥	⑥	⑥	160/3
750V	A	16/8	25/8	⑥	⑥	⑥	⑥	⑥	⑥	⑥
DC23A										
48V	A	16/1	25/1	32/1	45/1	63/1	40/1	63/1	100/1	160/1
110V	A	16/2	25/2	32/2	45/2	63/2	40/2	63/2	100/2	160/1
220V	A	16/4	25/4	32/4	45/4	63/4	40/4	63/4	63/4	160/2
440V	A	10/4	⑦	⑦	⑦	⑦	⑦	⑦	⑦	160/3
750V	A	16/8	⑦	⑦	⑦	⑦	⑦	⑦	⑦	⑦
Rated operational power										
AC23A										
230V	kW	3	4	5.5	11	22	7.5	11	22	45
400/415V	kW	7.5	9	11	22	37	15	18.5	37	75
500V	kW	7.5	9	11	22	37	15	18.5	37	75
690V	kW	7.5	9	11	15	18.5	15	15	37	75
Short-circuit current with back-up fuses of size ^①	kA	50	50	50	50	50	50	50	50	50
	A	25	32	40	63	80	100	100	200	

Fusible

Non-Fused

Enclosed Fused

Enclosed Non-Fused

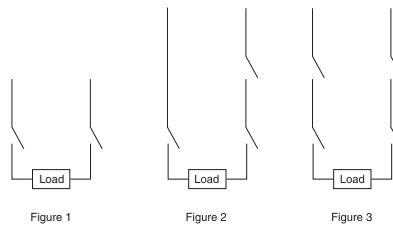

① 1000V, IEC 408.
 ② The ambient air temperature does not exceed +40°C and its average over a period of 24 hours does not exceed +35°C according to IEC 947.
 ③ IEC 947-3, utilization category B, infrequent operation.
 ④ Not available at time of printing, please consult factory.

CDNF200U03 – BDNF3150

IEC

Catalog number	3 pole	CDNF200U03	CDNF400U03	BDNF600A	BDNF800A	BDNF1200	BDNF1600	BDNF2000	BDNF3150
Rated insulation and operational voltage, AC20 and DC20 ^①	40°C 1000 V	1000	1000	1000	1000	1000	1000	1000	
Rated impulse withstand voltage	kV	12	12	12	8	8	8	8	8
Rated thermal current, I _{th}									
AC 20/DC 20	open ^② A	250	400	800	1250	1600	2500	2500	3150
	40°C enclosed A	250	400	720	1250	1600	2300	2300	2600
	60°C enclosed A	—	—	720	1250	1600	2300	2300	2600
Rated operational currents									
AC 21A	500V A	250	400	800	1250	1600	2500^③	2500^③	3150^③
	690V A	250	400	800	1250	1600	2500 ^③	2500 ^③	3150 ^③
	1000V ^① A	—	—	630	—	—	—	—	—
AC 22A	500V A	250	400	800	1250	1600	1600 ^③	1600 ^③	1600 ^③
	690V A	250	400	800	—	—	—	—	—
	1000V ^① A	—	—	400	—	—	—	—	—
AC 23A	415V A	250	400	720	800	800	800 ^③	800 ^③	800 ^③
	500V A	250	400	600	800	800	800 ^③	800 ^③	800 ^③
	690V A	250	400	350	—	—	—	—	—
	1000V ^① A	—	—	200	—	—	—	—	—
Rated operational currents/poles in series									
DC21A	48V A	250/1	630/2	800/2	1250/2	1600/2	2500/2	2500/2	3150/2
	110V A	250/2	630/2	800/2	1250/2	1600/2	2500/2	2500/2	3150/2
	220V A	250/2	630/2	800/2	1250/3	1600/2	2500/2	2500/2	3150/2
	440V A	250/3	630/3	800/3	—	1600/3	2500/3	2500/3	3150/2
	750V A	250/4	—	—	—	—	—	—	—
DC22A	48V A	250/1	630/2	800/2	1250/2	1600/2	2500/2	2500/2	3150/2
	110V A	250/2	630/2	800/2	1250/2	1600/2	2500/2	2500/2	3150/2
	220V A	250/2	630/2	800/2	1250/2	1600/2	2500/2	2500/2	3150/2
	440V A	250/3	630/3	800/3	—	—	—	—	—
	750V A	250/4	—	—	—	—	—	—	—
DC23A	48V A	250/1	630/2	—	—	—	—	—	—
	110V A	250/2	630/2	—	—	—	—	—	—
	220V A	250/2	630/2	—	—	—	—	—	—
	440V A	250/3	—	—	—	—	—	—	—
	750V A	250/4	—	—	—	—	—	—	—
Rated operational power									
AC23A	230V kW	75	110	200	250	250	250	250	250
	400/415V kW	132/140	220/230	355	400	400	400	400	400
	500V kW	170	280	400	450	450	450	450	450
	690V kW	240	355	355	—	—	—	—	—
Short-circuit current	kA	100	100	80	50	50	50	50	50
with back-up fuses of size ^①	A	400	800	800	1000	1250	1250	1250	1250



Figure 1



Figure 2



Figure 3

① 1000V, IEC 408.
② The ambient air temperature does not exceed +40°C and its average over a period of 24 hours does not exceed +35°C according to IEC 947.
③ IEC 947-3, utilization category B, infrequent operation.

IEC Technical Data for Non-Fusible Disconnect Switches



CDNF16 – CDNF160

IEC

Catalog number	3 pole	CDNF16	CDNF25	CDNF32	CDNF45	CDNF63	CDNF30	CDNF60	CDNF100	CDNF160
Rated voltage, U ^e	V/V	415	415	415	415	415	415	415	415	415/690
Rated conditional short-circuit current	kA	50	50	50	50	50	50	50	50	80/50
Max. allowed fuse size, type OFAA	A	16	32	40	63	80	100	100	100	160/250
Max. allowed cut-off current, peak value	kA	4	4.3	4.6	8.3	11	9.2	9.2	9.2	21.0/21.6
Rated short-circuit making capacity, prospective peak value, I ^{cm}	kA	0.7	0.7	1.4	1.4	3.6	3.6	3.6	12	
Rated short time withstand current, RMS I ^{cw}	0.2s kA	—	—	—	—	—	—	—	—	7
	1.0s kA	0.5	0.5	0.5	1	1	2.5	2.5	2.5	4
AC breaking capacity										
pf = 0.35										
415V	A	128	160	184	240	304	320	504	640	1080
500V	A	128	160	184	240	256	320	504	504	1000
690V	A	80	88	96	160	160	320	320	320	640
1000V ^①	A	—	—	—	—	—	—	—	—	—
DC breaking capacity/poles in series										
L/R = 15ms, 3 pole in series										
48V	A	64/1	100/1	128/1	180/1	252/1	160/1	252/1	400/1	640/1
110V	A	64/2	100/2	128/2	180/2	180/2	160/2	252/2	400/2	640/1
220V	A	64/3	100/4	128/4	180/4	180/4	160/4	252/4	252/4	640/2
440V	A	②	②	②	②	②	②	②	—	640/3
750V	A	②	②	②	②	②	②	②	—	—
Capacitor ratings	400/415V kVar	②	②	②	②	②	②	②	②	②
Rated capacitor duty	kA	②	②	②	②	②	②	②	②	②
Physical characteristics										
Electrical endurance at rated operational current, pf = 0.65	operation cycles	3000	3000	3000	3000	3000	3000	3000	3000	1000
Mechanical endurance	operations	20,000	20,000	20,000	20,000	20,000	20,000	20,000	20,000	16,000
Weight	3 pole kg	0.11	0.11	0.11	0.27	0.27	0.36	0.36	0.36	1.1
	4 pole kg	0.15	0.15	0.15	0.35	0.35	0.5	0.5	0.5	1.3
Dimension	3 pole H mm	68	68	91.5	91.5	100	100	100	127	
	W mm	35	35	35	52.5	52.5	70	70	70	126
	D mm	56	56	56	72.5	72.5	75	75	75	74.5
Power loss per pole	W	0.3	0.6	1	1.4	2.8	1	1.6	4	6.5
Shaft size — square	□ mm	6 x 6	6 x 6	6 x 6	6 x 6	6 x 6	6 x 6	6 x 6	6 x 6	6 x 6
Switch operating torque for rotary 3 pole switches	Nm	1	1	1	1.2	1.2	2	2	2	6
Suitable conductor cross section Cu	mm ²	0.75 – 10	0.75 – 10	0.75 – 10	1.5 – 35	1.5 – 35	1.5 – 25	1.5 – 25	1.5 – 25	10 – 70
Bolt size		—	—	—	—	—	—	—	—	—
Auxiliary contacts		CDAUX_ _	CDAUX_ _	CDAUX_ _	CDAUX_ _	CDAUX_ _	CDAUX_ _	CDAUX_ _	CDAUX_ _	CDAUX_ _
Ratings according to IEC 947-5-1										
Rated voltage, U _i	VAC	690	690	690	690	690	690	690	690	690
Thermal current, I _{th}	A	16	16	16	16	16	16	16	16	10
AC12/DC12 I _e , A U _e =										
120V	A	—	—	—	—	—	—	—	—	8/—
125V	A	—	—	—	—	—	—	—	—	—/1.1
240V	A	6 ^③	6 ^③	6 ^③	6 ^③	6 ^③	6 ^③	6 ^③	6 ^③	6/—
250V	A	—	—	—	—	—	—	—	—	—/0.55
400V	A	4 ^③	4 ^③	4 ^③	4 ^③	4 ^③	4 ^③	4 ^③	4 ^③	4/—
415V	A	—	—	—	—	—	—	—	—	4/—
440V	A	—	—	—	—	—	—	—	—	—/0.31
480V	A	—	—	—	—	—	—	—	—	3/—
500V	A	—	—	—	—	—	—	—	—	3/0.27
600V	A	—	—	—	—	—	—	—	—	—/0.2
690V	A	2 ^③	2 ^③	2 ^③	2 ^③	2 ^③	2 ^③	2 ^③	2 ^③	2/—

Fusible

Non-Fused

Enclosed Fused

Enclosed Non-Fused

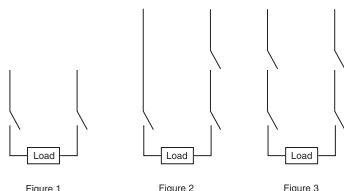

① 1000V, IEC 408.
 ② Not available at time of printing, please consult factory.
 ③ AC15, according to IEC947-5-1.

CDNF200U03 – BDNF3150

IEC

Catalog number	3 pole	CDNF200U03	CDNF400U03	BDNF600A	BDNF800A	BDNF1200	BDNF1600	BDNF2000	BDNF3150
Rated voltage, U _s	V/V	500/690	500/690	500/690	690	690	690	690	690
Rated conditional short-circuit current	kA	100/80	100/80	100/50	45	45	45	50	50
Max. allowed fuse size, type OFAA	A	350/355	500/500	800 [Ⓢ]	—	—	—	—	—
Max. allowed cut-off current, peak value	kA	40.5/40.5	615/59	62	—	—	—	—	—
Rated short-circuit making capacity, prospective peak value, I _{cm}	kA	35	30	65	105	105	115	115	115
Rated short time withstand current, RMS I _{sw} 0.2s	kA	15	28	38	100	100	110	110	110
RMS I _{sw} 1.0s	kA	8	15	17	50 [Ⓢ]	50 [Ⓢ]	50 [Ⓢ]	50 [Ⓢ]	50 [Ⓢ]
AC breaking capacity									
pf = 0.35									
415V	A	2000	3200	5780	6400	6400	6400	6400	6400
500V	A	2000	3200	4800	6400	6400	6400	6400	6400
690V	A	2000	3200	2800	2500 [Ⓢ]	2500 [Ⓢ]	4800 [Ⓢ]	4800 [Ⓢ]	4800 [Ⓢ]
DC breaking capacity/poles in series									
L/R = 15ms, 3 pole in series									
48V	A	1000/2	—	—	—	—	—	—	—
110V	A	1000/2	—	—	—	—	—	—	—
220V	A	1000/2	1600/2	2000/2	1900/2 [Ⓢ]	2600/2 [Ⓢ]	2600/2 [Ⓢ]	2600/2 [Ⓢ]	2600/2 [Ⓢ]
440V	A	1000/3	1600	2000	—	—	—	—	—
750V	A	1000/4	—	—	—	—	—	—	—
Capacitor ratings	400/415V	kVar	—	—	350	Ⓢ	Ⓢ	Ⓢ	Ⓢ
Rated capacitor duty	kA	—	—	500	Ⓢ	Ⓢ	Ⓢ	Ⓢ	Ⓢ
Physical characteristics									
Electrical endurance at rated operational current, pf = 0.65	operation cycles	1000	1000	500	500	500	100 [Ⓢ]	100 [Ⓢ]	100 [Ⓢ]
Mechanical endurance	operations	20,000	16,000	10,000	10,000	10,000	6000	6000	6000
Weight	3 pole	kg	1.2	2.2	6.2	16.3	17.5	37	37
	4 pole	kg	1.6	2.6	7.6	20.5	22.5	47	47
Dimension	3 pole	H mm	212	216	485	485	636	636	636
		W mm	219	260	303	363	363	468	468
		D mm	92.5	130	130	125	125	271	271
Power loss per one pole	W	6.5	10	40	40	67	90	90	140
Shaft size — square □	mm	6 x 6	12 x 12	12 x 12	12 x 12	12 x 12	12 x 12	12 x 12	12 x 12
Switch operating torque for rotary 3 pole switches	Nm	7	16	21	21	21	50	50	50
Suitable conductor cross section Cu	mm ²	—	—	—	—	—	—	—	—
Bolt size		8 x 25	10 x 30	12 x 40	12 x 60	12 x 60	12 x 60	12 x 60	12 x 60
Auxiliary contacts		CDAUX_ _	CDAUX_ _	BDAUX_ _	BDAUX_ _	BDAUX_ _	BDAUX_ _	BDAUX_ _	BDAUX_ _
Ratings according to IEC 947-5-1									
Rated voltage, U _i	VAC	690	690	690	690	690	690	690	690
Thermal rated current, I _{th}	A	16	16	10	10	10	10	10	10
AC12/DC12 I _a , A U _s =									
120V	A	—	—	—	8/—	8/—	8/—	8/—	8/—
125V	A	—	—	—	—/1.1	—/1.1	—/1.1	—/1.1	—/1.1
240V	A	6/—	6/—	6/—	6/—	6/—	6/—	6/—	6/—
250V	A	—	—	—/0.55	—/0.55	—/0.55	—/0.55	—/0.55	—/0.55
400V	A	4/—	4/—	4/—	4/—	4/—	4/—	4/—	4/—
415V	A	—	—	4/—	4/—	4/—	4/—	4/—	4/—
440V	A	—	—	—/0.31	—/0.31	—/0.31	—/0.31	—/0.31	—/0.31
480V	A	—	—	3/—	3/—	3/—	3/—	3/—	3/—
500V	A	—	—	3/0.27	3/0.27	3/0.27	3/0.27	3/0.27	3/0.27
600V	A	—	—	—/0.2	—/0.2	—/0.2	—/0.2	—/0.2	—/0.2
690V	A	2/—	2/—	2/—	2/—	2/—	2/—	2/—	2/—

Ⓢ Not available at time of printing, please consult factory.
[Ⓢ] Size 4.
[Ⓢ] Maximum distance between busbar support and switch terminal 70mm.
[Ⓢ] pf 0.95.
[Ⓢ] pf 0.65.
[Ⓢ] IEC 947-3, utilization category B, infrequent operation.

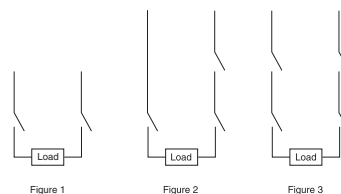

Approximate Dimensions for Non-Fusible Disconnect Switches



CDNF16A3 – CDFN100A3

CDNF16A3, CDFN25A3, CDFN32A3 — base & DIN rail mounted switch

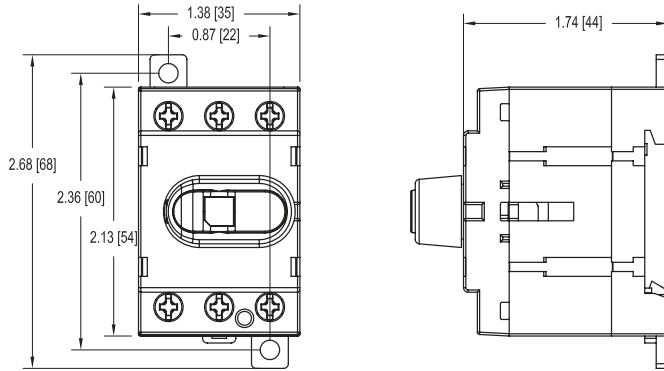

CDNF45A3, CDFN63A3 — base & DIN rail mounted switch

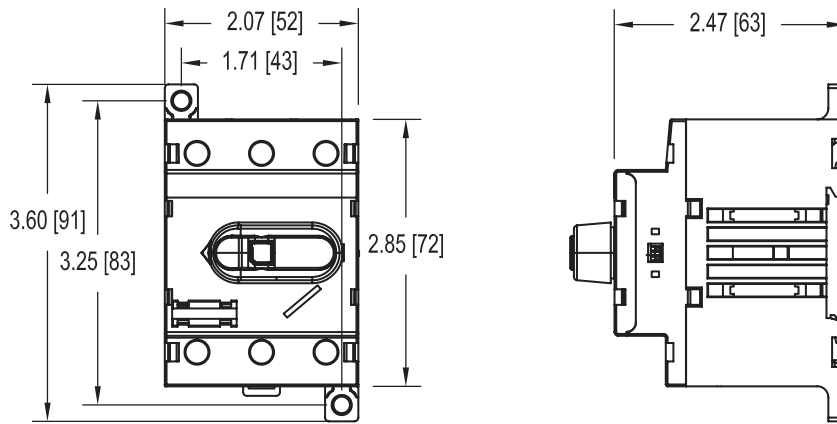

CDNF30A3, CDFN60A3, CDFN100A3 — base & DIN rail mounted switch

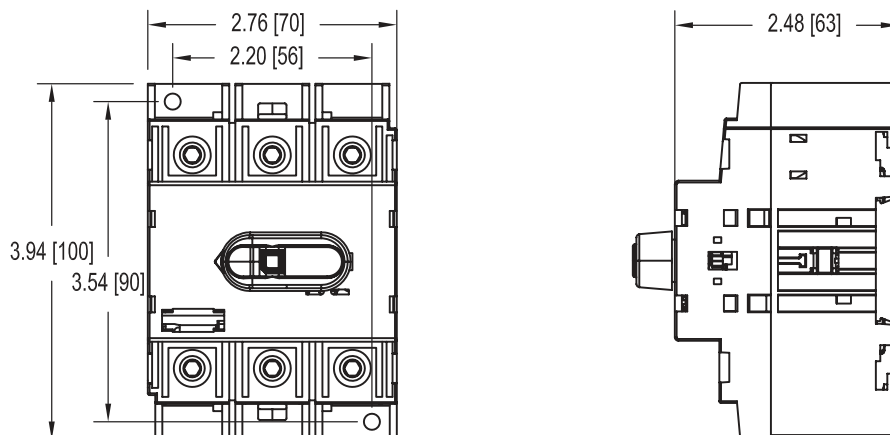

Fusible

Non-Fused

Enclosed Fused

Enclosed Non-Fused

CDNF16A3D – CDFN100A3D

CDNF16A3D, CDFN25A3D, CDFN32A3D — door mounted switch

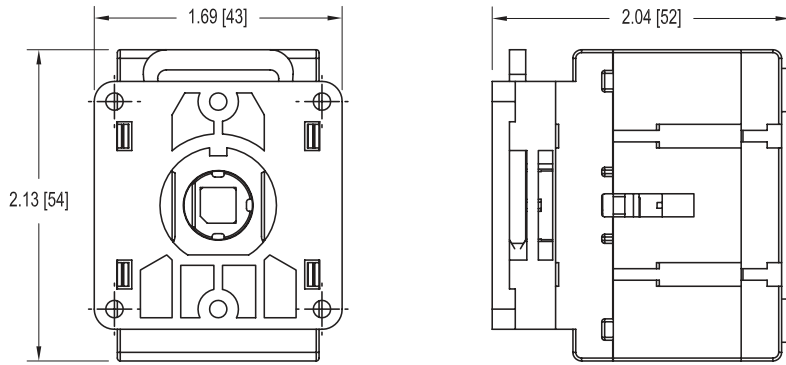

Fusible

CDNF45A3D, CDFN63A3D — door mounted switch

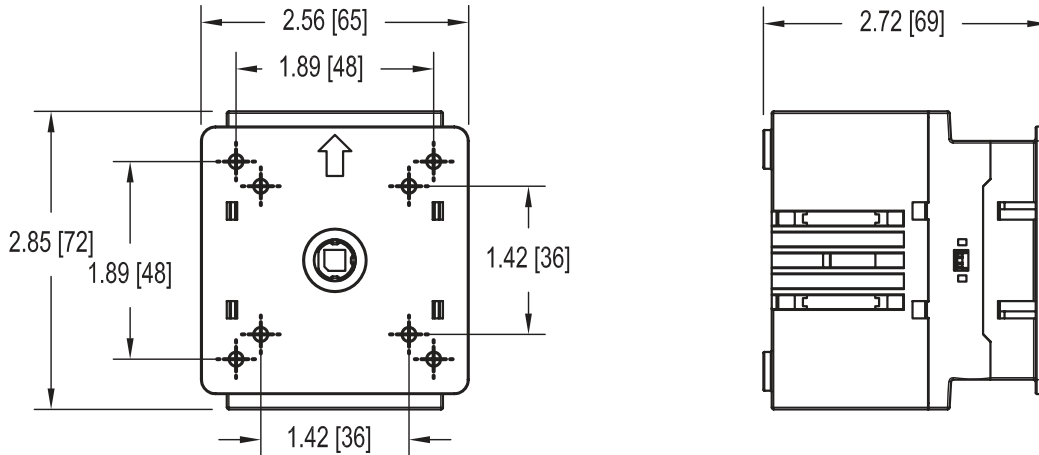

Non-Fused

Enclosed Fused

CDNF30A3D, CDFN60A3D, CDFN100A3D — door mounted switch

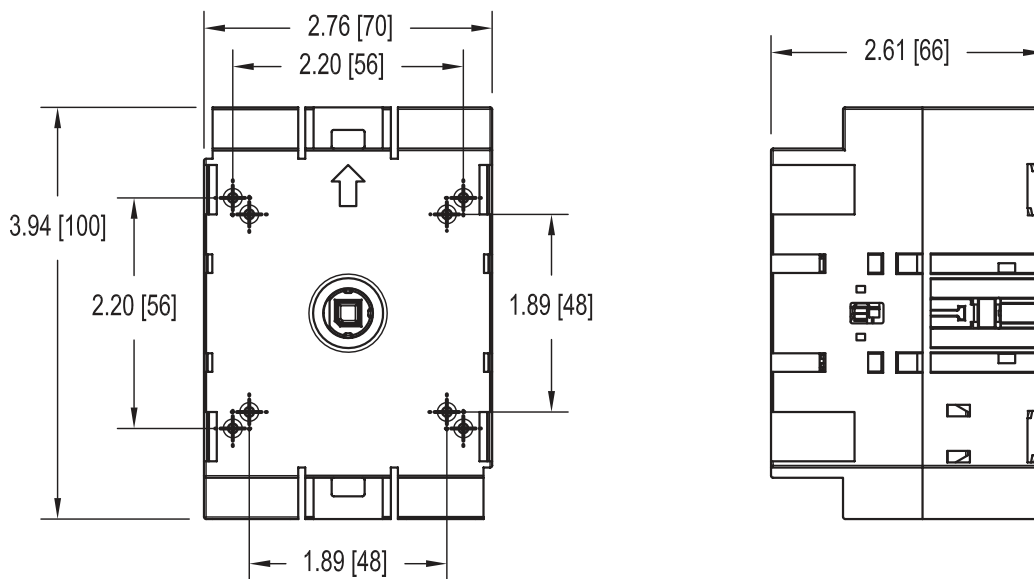

Enclosed Non-Fused

Approximate Dimensions for Non-Fusible Disconnect Switches



CDNF200U03

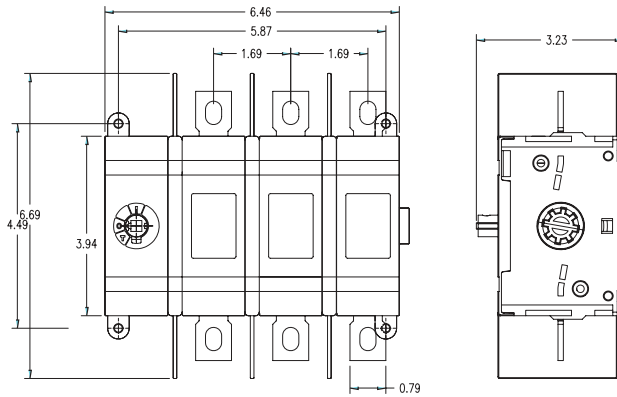

CDNF400U03

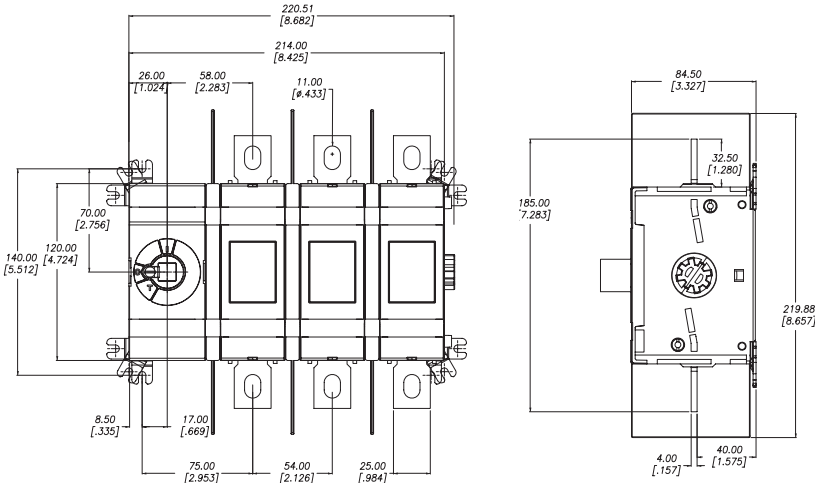

BDNF600A

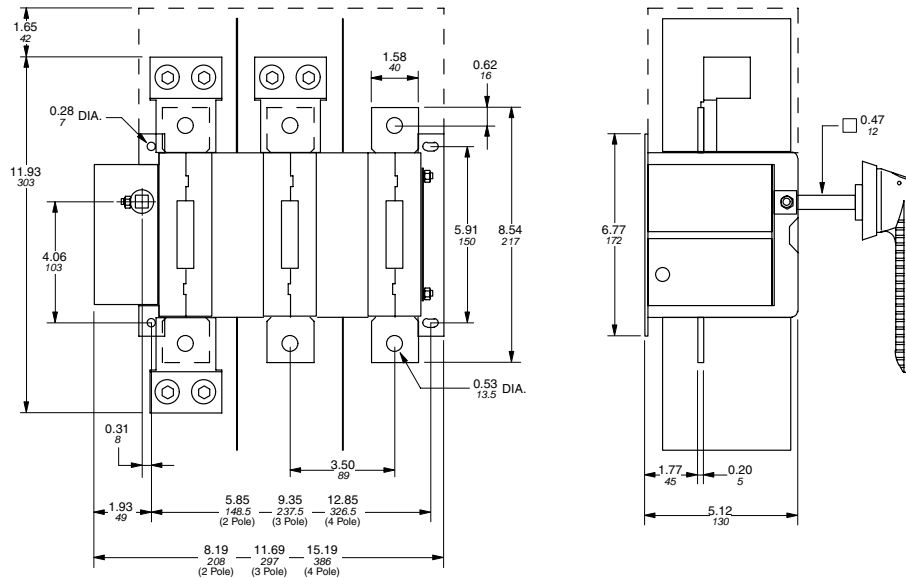

Fusible

Non-Fused

Enclosed Fused

Enclosed Non-Fused

BDNF800A - BDNF1200

BDNF800A

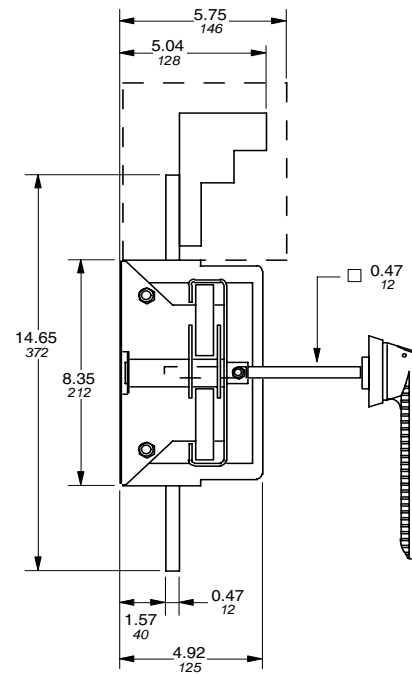
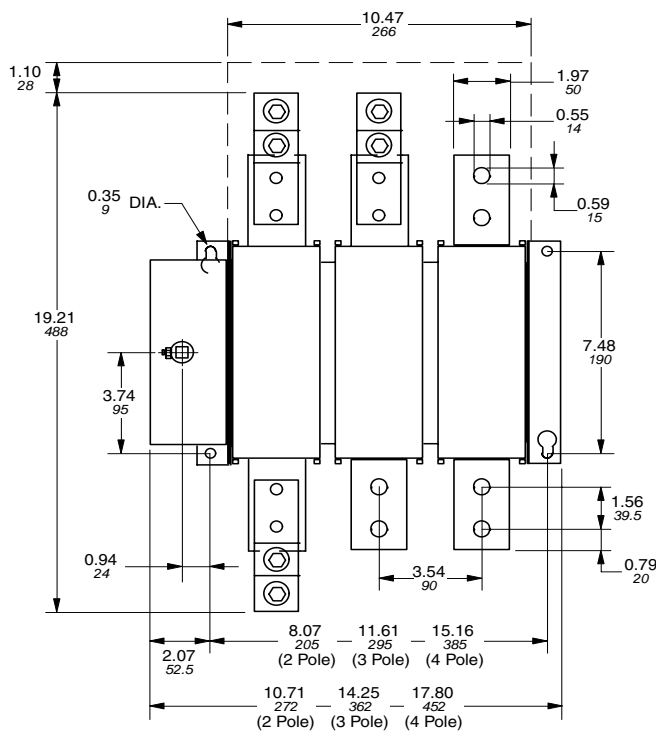

BDNF1200

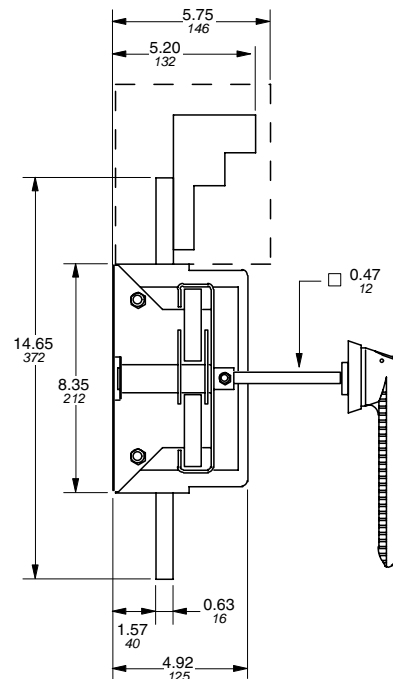
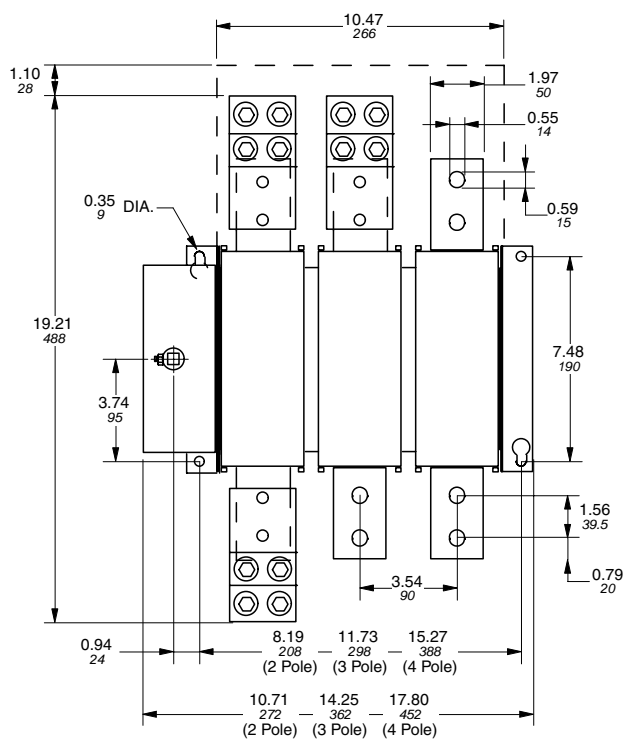

Approximate Dimensions for Non-Fusible Disconnect Switches



BDNF1600 – BDNF3150

BDNF1600

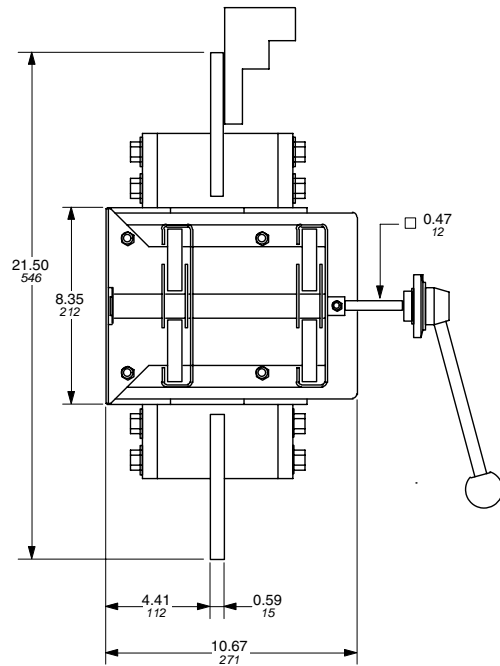
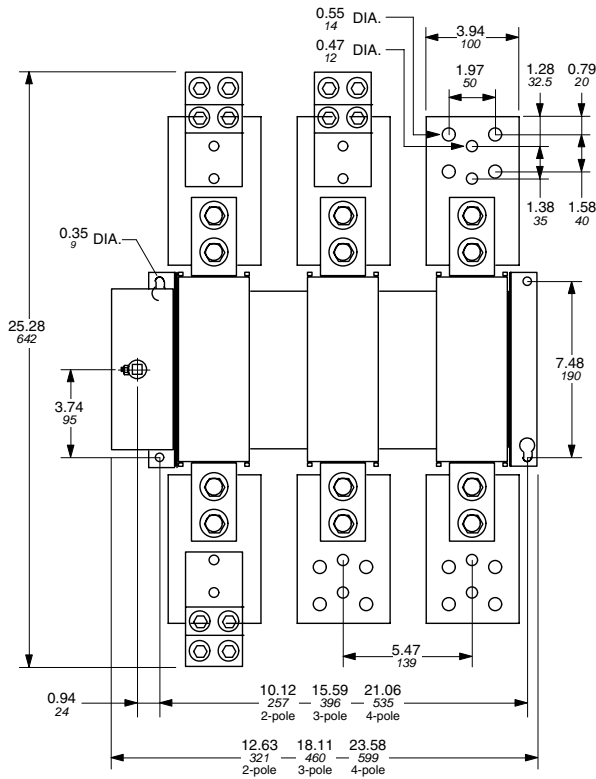

BDNF2000 – BDNF3150

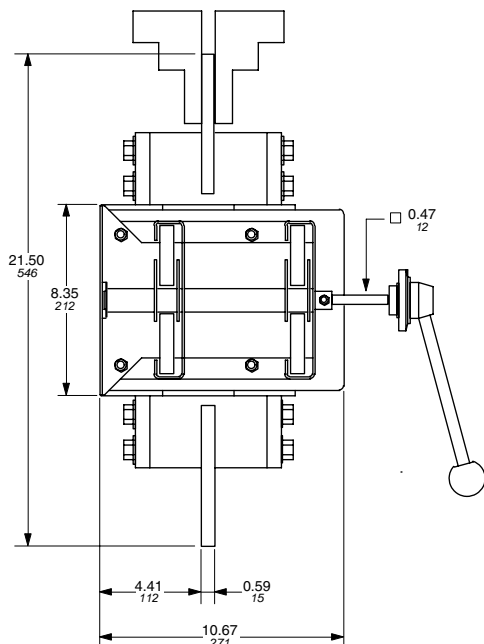
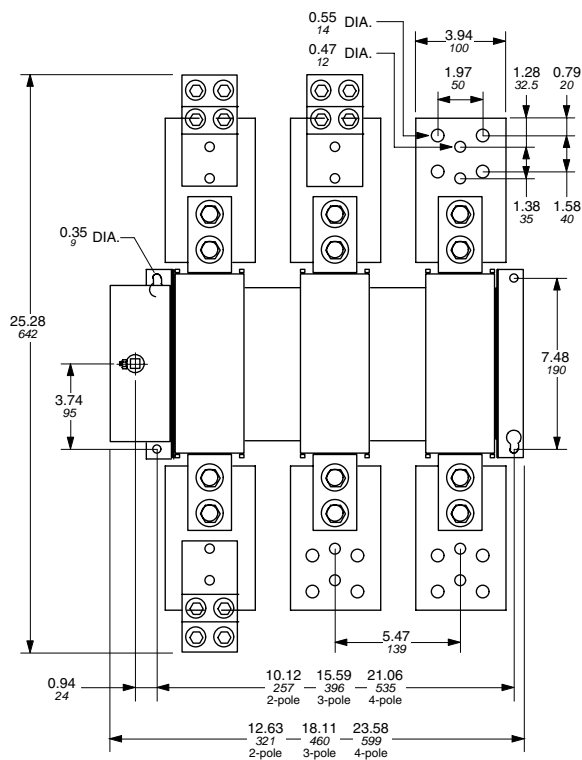

Fusible

Non-Fused

Enclosed Fused

Enclosed Non-Fused

CDTL200/3P — for use with 200A switches

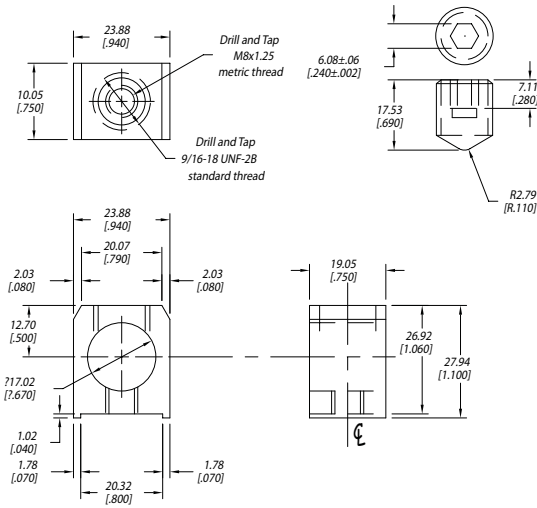

BDSL27 — for use with 600A switches

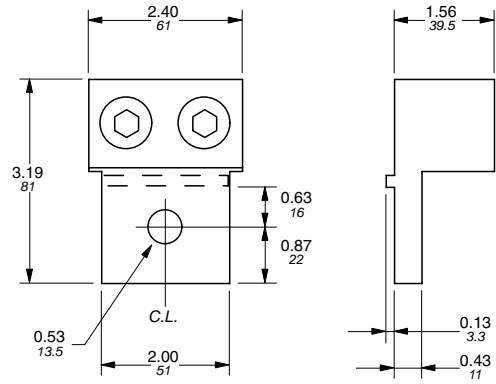

CDTL206 — for use with 200A switches

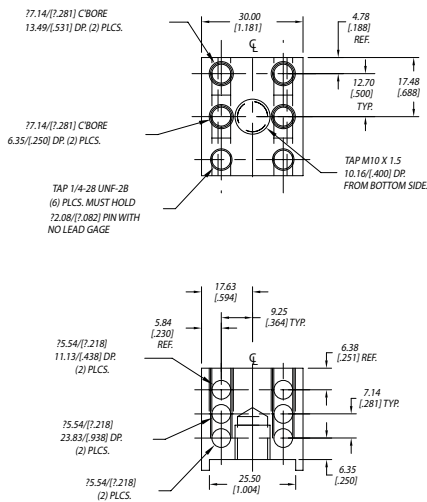

BDSL30 — for use with 800A switches

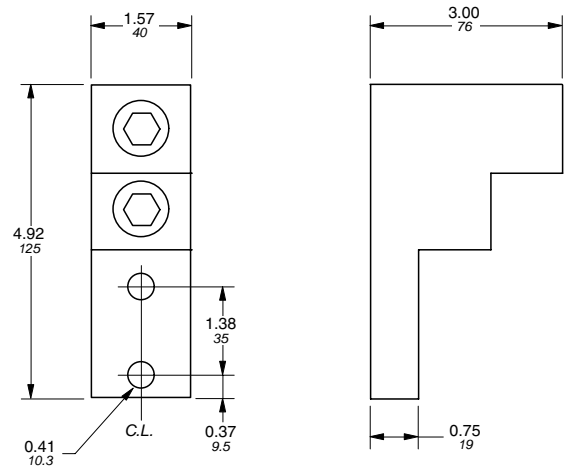

CDTL400/3P — for use with 400A switches

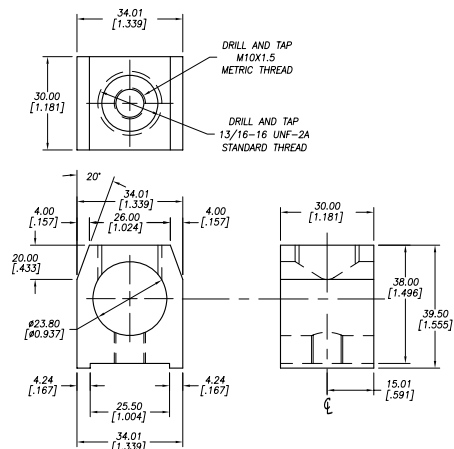

BDSL28 & BDSL28/2 — for use with 1200A – 3150A switches

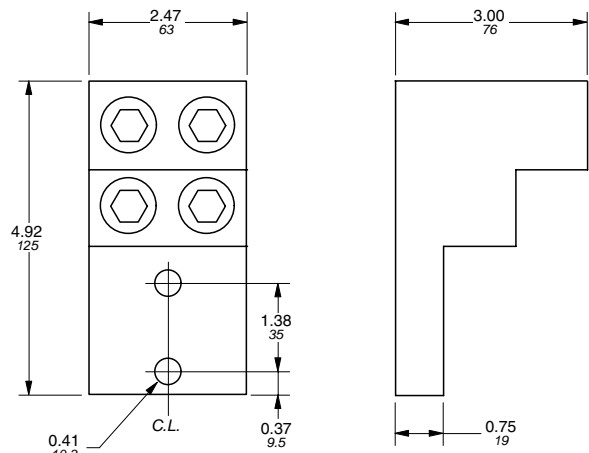

Fusible

Non-Fused

Enclosed Fused

Enclosed Non-Fused

30A – 800A

Enclosed Fusible Disconnect Switches



EFJ30X-3PB6

3 Pole^①, 600V, 30A - 3150A

NEMA / UL Enclosure type

UL general purpose amp rating	Fuse type	NEMA / UL Enclosure type					
		1 Catalog number	3R Catalog number	4 Catalog number	4X Stainless Catalog number	4X Plastic Catalog number	12 Catalog number
30	J	EFJ301-3PB6	EFJ303-3PB6	EFJ304-3PB6	EFJ30X-3PB6	EFJ30P-3PB6	EFJ302-3PB6
30	CC	EFC301-3PB6	EFC303-3PB6	EFC304-3PB6	EFC30X-3PB6	EFC30P-3PB6	EFC302-3PB6
60	J	EFC601-3PB6	EFC303-3PB6	EFC604-3PB8	EFC60X-3PB8	EFJ60P-3PB8	EFJ602-3PB6
100	J	EFJ1001-3PB8	EFJ1003-3PB8	EFJ1004-3PB8	EFJ100X-3PB8	EFJ100P-3PB8	EFJ1002-3PB8
200	J ^②	EFJ2001-3PB8C	EFJ2003-3PB8C	EFJ2004-3PB8C	EFJ200X-3PB8C	EFJ200P-3PB8C	EFJ2002-3PB8C
400	J ^②	EFJ4001-3PB4	EFJ4003-3PB4	EFJ4004-3PB4	EFJ400X-3PB4	EFJ400P-3PB4	EFJ4002-3PB4
600	J ^②	EFJ6001-3PB4	EFJ6003-3PB4	EFJ6004-3PB4	EFJ600X-3PB4	EFJ600P-3PB4	EFJ6002-3PB4
800	L	EFJ8001-3PB4	EFJ8003-3PB4	EFJ8004-3PB4	EFJ800X-3PB4	EFJ800P-3PB4	EFJ8002-3PB4

Switch ratings

UL general purpose amp rating	Maximum horsepower rating								Wire size for terminal lugs	For wire type	Approval ^①
	Single phase			Three phase							
	120V	200V	240V	200V	208V	240V	480V	600V			
30	2	3	5	5	7.5	7.5	15	20	#18 – 8	Cu	cULus, UL
60	3	7.5	10	15	15	15	30	50	#14 – 4	Cu	cULus, UL
100	5	10	15	25	25	30	60	75	#14 – 2/0	Cu/Al	cULus, UL
200	—	—	—	50	50	60	125	150	#4 – 300 kcmil	Cu/Al	cULus, UL
400	—	—	—	100	125	125	250	350	#2 – 600 kcmil	Cu/Al	cULus, UL
600	—	—	—	150	150	200	400	500	(2) #2 – 600 kcmil	Cu/Al	cULus, UL
800	—	—	—	200	200	250	500	600	(2) #2 – 600 kcmil	Cu/Al	cULus, UL

① Fusible switches are UL Listed to the UL98 standard.

② 600V T type fuse clips may be substituted at no charge. Please change the second character of the catalog number from "J" to "T."

Fusible

Non-Fused

Enclosed Fused

Enclosed Non-Fused

Fusible

Non-Fused

Enclosed Fused

Enclosed Non-Fused

NEMA / UL Enclosure type

UL general purpose amp rating	Type of Switch	NEMA / UL Enclosure type					
		1	3R	4	4X Stainless	4X Plastic	12
		Catalog number	Catalog number	Catalog number	Catalog number	Catalog number	Catalog number
30 (J fuses)	4 Pole ^①	EFJ301-4PB6	EFJ303-4PB6	EFJ304-4PB6	EFJ30X-4PB6	EFJ30P-4PB6	EFJ302-4PB6
	6 Pole	EFJ301-6PB6	EFJ303-6PB6	EFJ304-6PB6	EFJ30X-6PB	EFJ30P-6PB6	EFJ302-6PB6
30 (CC fuses)	4 Pole ^①	EFC301-4PB6	EFC303-4PB6	EFC304-4PB6	EFC30X-4PB6	EFC30P-4PB6	EFC302-4PB6
	6 Pole	EFC301-6PB6	EFC303-6PB6	EFC304-6PB6	EFC30X-6PB6	EFC30P-6PB6	EFC302-6PB6
60	4 Pole ^①	EFJ601-4PB6	EFJ603-4PB6	EFJ604-4PB6	EFJ60X-4PB6	EFJ60P-4PB6	EFJ602-4PB6
	6 Pole	EFJ601-6PB4	EFJ603-6PB4	EFJ604-6PB4	EFJ60X-6PB4	EFJ60P-6PB4	EFJ602-6PB4
100	2 Pole ^①	EFJ1001-2PB8	EFJ1003-2PB8	EFJ1004-2PB8	EFJ100X-2PB8	EFJ100P-2PB8	EFJ1002-2PB8
	4 Pole ^①	EFJ1001-4PB8	EFJ1003-4PB8	EFJ1004-4PB8	EFJ100X-4PB8	EFJ100P-4PB8	EFJ1002-4PB8
	6 Pole	EFJ1001-6PB4	EFJ1003-6PB4	EFJ1004-6PB4	EFJ100X-6PB4	EFJ100P-6PB4	EFJ1002-6PB4
200	4 Pole ^①	EFJ2001-4PB8C	EFJ2003-4PB8C	EFJ2004-4PB8C	EFJ200X-4PB8C	EFJ200P-4PB8C	EFJ2002-4PB8C
	6 Pole	—	—	—	—	—	—
400	2 Pole ^①	EFJ4001-2PB4	EFJ4003-2PB4	EFJ4004-2PB4	EFJ400X-2PB4	EFJ400P-2PB4	EFJ4002-2PB4
	4 Pole ^①	EFJ4001-4PB4	EFJ4003-4PB4	EFJ4004-4PB4	EFJ400X-4PB4	EFJ400P-4PB4	EFJ4002-4PB4
	6 Pole	EFJ4001-6P8	EFJ4003-6P8	EFJ4004-6P8	EFJ400X-6P8	EFJ400P-6P8	EFJ4002-6P8
600	2 Pole ^①	EFJ6001-2PB4	EFJ6003-2PB4	EFJ6004-2PB4	EFJ600X-2PB4	EFJ600P-2PB4	EFJ6002-2PB4
	4 Pole ^①	EFJ6001-4PB4	EFJ6003-4PB4	EFJ6004-4PB4	EFJ600X-4PB4	EFJ600P-4PB4	EFJ6002-4PB4
	6 Pole	EFJ6001-6P8	EFJ6003-6P8	EFJ6004-6P8	EFJ600X-6P8	EFJ600P-6P8	EFJ6002-6P8
800	2 Pole ^①	EFL8001-2PB4	EFL8003-2PB4	EFL8004-2PB4	EFL800X-2PB4	EFL800P-2PB4	EFL8002-2PB4
	4 Pole ^①	EFL8001-4PB4	EFL8003-4PB4	EFL8004-4PB4	EFL800X-4PB4	EFL800P-4PB4	EFL8002-4PB4
	6 Pole	EFL8001-6P8	EFL8003-6P8	EFL8004-6P8	EFL800X-6P8	EFL800P-6P8	EFL8002-6P8

2 Pole



4 Pole

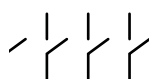

6 Pole

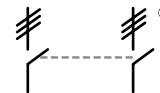

Handle ratings

Amperage range	Style type	NEMA	Color	Marking	Defeatable	Padlockable	Catalog number suffix	Catalog number
30	Selector	1,3R,12	Black	0/I & OFF/ON	Yes	Yes	BJ	CDH5S
	Selector	1,3R,12	Red/Yel	0/I & OFF/ON	Yes	Yes	YJ	CDH6S
	Pistol	1,3R,12	Black	0/I & OFF/ON	Yes	Yes	B6	BDH106
	Pistol	1,3R,12	Red/Yel	0/I & OFF/ON	Yes	Yes	Y6	BDH107
	Pistol	1,3R,4,4X,12	Black	0/I & OFF/ON	Yes	Yes	B6	CDHXB65
	Pistol	1,3R,4,4X,12	Red/Yel	0/I & OFF/ON	Yes	Yes	Y6	CDHXY65
60 – 100 and 200A 3 & 4 Pole	Pistol	1,3R,12	Black	0/I & OFF/ON	Yes	Yes	B6	BDH58
	Pistol	1,3R,12	Red/Yel	0/I & OFF/ON	Yes	Yes	Y6	BDH59
	Pistol	1,3R,12	Black	0/I & OFF/ON	Yes	Yes	B8	BDH60
	Pistol	1,3R,12	Red/Yel	0/I & OFF/ON	Yes	Yes	Y8	BDH61
	Pistol	1,3R,4,4X,12	Black	0/I & OFF/ON	Yes	Yes	B8	CDHXB86
	Pistol	1,3R,4,4X,12	Red/Yel	0/I & OFF/ON	Yes	Yes	Y8	CDHXY86
400A – 800A	Pistol	1,3R,12	Black	0/I & OFF/ON	Yes	Yes	B4	BDH114
	Pistol	1,3R,12	Red/Yel	0/I & OFF/ON	Yes	Yes	Y4	BDH115
	Pistol	1,3R,12	Black	0/I & OFF/ON	Yes	Yes	B7	BDH116
	Pistol	1,3R,12	Red/Yel	0/I & OFF/ON	Yes	Yes	Y7	BDH117
	Pistol	1,3R 4,4X,12	Black	0/I & OFF/ON	Yes	Yes	B4	CDHXB12
	Pistol	1,3R,4,4X,12	Red/Yel	0/I & OFF/ON	Yes	Yes	Y4	CDHXY12
	Pistol	1,3R,4,4X,12	Black	0/I & OFF/ON	Yes	Yes	B7	CDHXB22
	Pistol	1,3R,4,4X,12	Red/Yel	0/I & OFF/ON	Yes	Yes	Y7	CDHXY22
	Pistol	1,3R,4,4X,12	Metal	0/I & OFF/ON	No	Yes	8	BDH8

① Fusible switches are UL Listed to the UL98 standard.

② 600V T type fuse clips may be substituted at no charge. Please change the second character of the catalog number from "J" to "T."

Accessories for Enclosed Fusible Disconnect Switches



16A – 3150A NF



BDAUX157

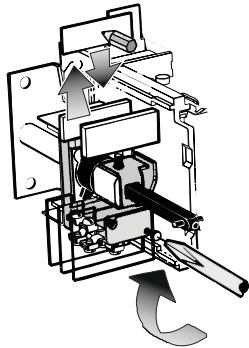

BDAUX7
BDAUX8

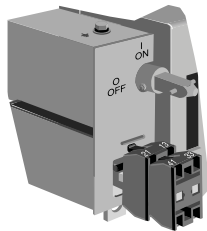

BDAUX1
BDAUX2



3 Position selection switch



Pilot light

Auxiliary Contacts

For use on:	Contact configuration	Catalog number	Installation suffix
30A	1 N.O. + 1 N.C.	BDAUX157	add "11" suffix
	2 N.O. + 2 N.C.		add "22" suffix
60A – 200A	1 N.O.	CDAUX10 CDAUX01K	add "10" suffix
	1 N.C.		add "01" suffix
400A – 800A	1 N.O. & 1 N.C.	BDAUX1 BDAUX12	add "11" suffix
	2 N.O. & 2 N.C.		add "22" suffix

Accessories

For use on:	Description	Installation suffix
30A	Neutral block	N
60A – 100A	Neutral block	N
200A – 400A	Neutral block	N
600A – 800A	Neutral block	N
30A – 200A	Service entrance, 3 wire	U
	Service entrance, 4 wire	V
400A – 800A	Service entrance, 3 wire	U
	Service entrance, 4 wire	V
30A – 800A	Start/stop pushbuttons	A
	2 position selector switch	C
	3 position selector switch	D
	Pilot light "red/run"	E
	Ammeter 1 phase	AM
	Voltmeter	VM

Ground Lugs

All enclosed switches are provided with a standard integral ground lug.

Switch size	Ground lug wire size
30	(2) # 14
60	#14 – 1/0
100 – 400	#6 – 250
600 – 800	#2 – 600 mcm

Conversion mechanisms

6 or 8 pole

6 (8) pole mechanism allows two switches controlled by one handle to open or close simultaneously.

②

	POS. O	POS. I
SW. A	O	X
SW. B	O	X

X = Closed
O = Open

① Transfer and bypass enclosed switches include the load side bussed or cabled together, and all switches come standard with ground lugs.

② ⚡ = Three poles

Fusible

Non-Fused

Enclosed Fused

Enclosed Non-Fused

16A - 3150A NF; 30A - 800A F

2, 3 & 4² Pole Fusible switches

Frame	Enclosure	H	W	D	MH	MW	Weight
		Height	Width	Depth	Mtg Height	Mtg Width	
CFD30_	1	10.00	8.00	5.00	7.00	7.00	12.0
	3R	10.00	8.00	5.00	10.75	6.00	12.0
	4	10.00	8.00	6.00	10.75	6.00	12.0
	4X SS	10.00	8.00	5.00	10.75	6.00	12.0
	4X Plastic	10.00	8.00	5.90	10.75	6.00	8.0
12	10.00	8.00	5.00	10.75	6.00	12.0	
CFD60_	1	10.00	8.00	6.00	7.00	7.00	13.0
	3R	10.00	8.00	6.00	10.75	6.00	13.0
	4	10.00	8.00	6.00	10.75	6.00	13.0
	4X SS	10.00	8.00	6.00	10.75	6.00	13.0
	4X Plastic	10.00	8.00	5.90	10.75	6.00	9.0
12	10.00	8.00	6.00	10.75	6.00	13.0	
CFD100_	1	14.00	12.00	8.00	11.00	9.00	22.00
	3R	14.00	12.00	8.00	14.75	10.00	22.00
	4	14.00	12.00	8.00	14.75	10.00	22.00
	4X SS	14.00	12.00	8.00	14.75	10.00	22.00
	4X Plastic	14.00	12.00	8.00	14.75	10.00	16.00
12	14.00	12.00	8.00	14.75	10.00	22.00	
CFD200_	1	24.00	16.00	8.00	25.50	18.50	75.00
	3R	24.00	16.00	8.00	25.50	18.50	75.00
	4	24.00	16.00	8.00	25.50	18.50	75.00
	4X SS	24.00	16.00	8.00	25.50	18.50	75.00
	4X Plastic	⊙	⊙	⊙	⊙	⊙	⊙
12	24.00	16.00	10.00	25.50	18.00	75.00	
FD400_	1	44.00	22.00	11.00	45.50	20.50	150.00
	3R	44.00	22.00	11.00	49.50	20.50	150.00
	4	48.00	24.00	12.00	49.50	22.50	150.00
	4X SS	48.00	24.00	12.00	49.50	22.50	150.00
	4X Plastic	⊙	⊙	⊙	⊙	⊙	⊙
12	44.00	22.00	11.00	45.50	20.50	150.00	
FD600_	1	44.00	22.00	11.00	45.50	20.50	150.00
	3R	44.00	22.00	11.00	49.50	20.50	150.00
	4	48.00	24.00	12.00	49.50	22.50	150.00
	4X SS	48.00	24.00	12.00	49.50	22.50	150.00
	4X Plastic	⊙	⊙	⊙	⊙	⊙	⊙
12	44.00	22.00	11.00	45.50	20.50	150.00	
FD800_	1	48.00	24.00	12.00	49.50	22.50	170.00
	3R	48.00	24.00	12.00	49.50	22.50	170.00
	4	48.00	24.00	12.00	49.50	22.50	170.00
	4X SS	48.00	24.00	12.00	49.50	22.50	170.00
	4X Plastic	⊙	⊙	⊙	⊙	⊙	⊙
12	48.00	24.00	12.00	49.50	22.50	170.00	

6 Pole Fusible switches

Frame	Enclosure	H	W	D	MH	MW	Weight
Size	type	Height	Width	Depth	Mtg Height	Mtg Width	
CFD30_	1	14.00	12.00	8.00	11.00	9.00	22.00
	3R	14.00	12.00	8.00	14.75	10.00	22.00
	4	14.00	12.00	8.00	14.75	10.00	22.00
	4X SS	14.00	12.00	8.00	14.75	10.00	22.00
	4X Plastic	14.00	12.00	8.00	14.75	10.00	16.00
12	14.00	12.00	8.00	14.75	10.00	22.00	
CFD60_	1	20.00	20.00	8.00	21.50	18.50	60.00
	3R	20.00	20.00	8.00	21.50	18.50	60.00
	4	20.00	20.00	8.00	21.50	18.50	60.00
	4X SS	20.00	20.00	8.00	21.50	18.50	60.00
	4X Plastic	24.00	16.00	10.00	—	—	60.00
12	20.00	20.00	8.00	21.50	18.50	60.00	
CFD100_	1	20.00	20.00	8.00	21.50	18.50	60.00
	3R	20.00	20.00	8.00	21.50	18.50	60.00
	4	20.00	20.00	8.00	21.50	18.50	60.00
	4X SS	20.00	20.00	8.00	21.50	18.50	60.00
	4X	24.00	16.00	10.00	21.50	18.50	60.00
12	20.00	20.00	8.00	21.50	18.50	60.00	
CFD200_	1	36.00	30.00	12.00	37.50	28.50	100.0
	3R	36.00	30.00	12.00	37.50	28.50	100.0
	4	36.00	30.00	12.00	37.50	28.50	100.0
	4X SS	36.00	30.00	12.00	37.50	28.50	100.0
	4X Plastic	⊙	⊙	⊙	⊙	⊙	⊙
12	36.00	30.00	12.00	37.50	28.50	100.0	
FD400_	1	48.00	36.00	16.00	49.50	34.50	220.00
	3R	48.00	36.00	16.00	49.50	34.50	220.00
	4	48.00	36.00	16.00	49.50	34.50	220.00
	4X SS	48.00	36.00	16.00	49.50	34.50	220.00
	4X Plastic	⊙	⊙	⊙	⊙	⊙	⊙
12	48.00	36.00	16.00	49.50	34.50	220.00	
FD600_	1	48.00	36.00	16.00	49.50	34.50	230.00
	3R	48.00	36.00	16.00	49.50	34.50	230.00
	4	48.00	36.00	16.00	49.50	34.50	230.00
	4X SS	48.00	36.00	16.00	49.50	34.50	230.00
	4X Plastic	⊙	⊙	⊙	⊙	⊙	⊙
12	48.00	36.00	16.00	49.50	34.50	230.00	
FD800_	1	48.00	36.00	16.00	49.50	34.50	230.00
	3R	48.00	36.00	16.00	49.50	34.50	230.00
	4	48.00	36.00	16.00	49.50	34.50	230.00
	4X SS	48.00	36.00	16.00	49.50	34.50	230.00
	4X Plastic	⊙	⊙	⊙	⊙	⊙	⊙
12	48.00	36.00	16.00	49.50	34.50	230.00	

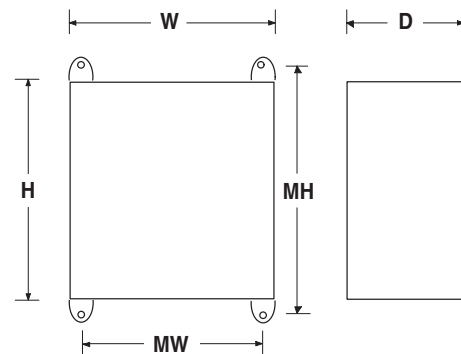

²
¹ Please consult factory.
² Some 4-pole switches require larger enclosures. Please consult factory.

16A – 3150A Enclosed Non-Fusible Disconnect Switches



ENF321-3PBJ

ENF63X-3PB6

3 Pole, 600V, 16A – 100A — Selector handle

UL general purpose amp rating	NEMA Enclosure type			
	1	3R	4 [Ⓞ] Selector handles are only NEMA rated 1, 3R, 12	4X Stainless [Ⓞ] Selector handles are only NEMA rated 1, 3R, 12
	Catalog number	Catalog number	Catalog number	Catalog number
16	ENF161-3PBJ	ENF163-3PBJ	ENF164-3PBJ	ENF16X-3PBJ
25	ENF251-3PBJ	ENF253-3PBJ	ENF254-3PBJ	ENF25X-3PBJ
40	ENF321-3PBJ	ENF323-3PBJ	ENF324-3PBJ	ENF32X-3PBJ
60	ENF451-3PBJ	ENF453-3PBJ	ENF454-3PBJ	ENF45X-3PBJ
80	ENF631-3PBJ	ENF633-3PBJ	ENF634-3PBJ	ENF63X-3PBJ

3 Pole, 600V, 16A – 3150A — Pistol handle

UL general purpose amp rating	NEMA Enclosure type				
	1	3R	4	4X Stainless	
	Catalog number	Catalog number	Catalog number	Catalog number	
UL 508	16	ENF161-3PB6	ENF163-3PB6	ENF164-3PB6	ENF16X-3PB6
	25	ENF251-3PB6	ENF253-3PB6	ENF254-3PB6	ENF25X-3PB6
	40	ENF321-3PB6	ENF323-3PB6	ENF324-3PB6	ENF32X-3PB6
	60	ENF451-3PB6	ENF453-3PB6	ENF454-3PB6	ENF45X-3PB6
	80	ENF631-3PB6	ENF633-3PB6	ENF634-3PB6	ENF63X-3PB6
UL 98	30	ENF301-3PB6	ENF303-3PB6	ENF304-3PB6	ENF30X-3PB6
	60	ENF601-3PB6	ENF603-3PB6	ENF604-3PB6	ENF60X-3PB6
	100	ENF1001-3PB6	ENF1003-3PB6	ENF1004-3PB6	ENF100X-3PB6
	125	ENF1251-3PB6	ENF1253-3PB6	ENF1254-3PB6	ENF125X-3PB6
	200	ENF2001-3PB8B	ENF2003-3PB8B	ENF2004-3PB8B	ENF200X-3PB8B
	400	ENF4001-3PB4B	ENF4003-3PB4B	ENF4004-3PB4B	ENF400X-3PB4B
	600	ENF6001-3PB4	ENF6003-3PB4	ENF6004-3PB4	ENF600X-3PB4
	800	ENF8001-3PB4	ENF8003-3PB4	ENF8004-3PB4	ENF800X-3PB4
	1200	ENF12001-3PB4	ENF12003-3PB4	ENF12004-3PB4	ENF1200X-3PB4
	1600	ENF16001-3P8	ENF16003-3P8	ENF16004-3P8	ENF1600X-3P8
2000	ENF20001-3P8	ENF20003-3P8	ENF20004-3P8	ENF2000X-3P8	
3150 [Ⓞ]	ENF31501-3P8	ENF31503-3P8	ENF31504-3P8	ENF3150X-3P8	

Ⓞ Enclosures are rated as listed, selector handles are only NEMA rated 1, 3R, 12. The overall NEMA rating of an enclosed switch with a selector handle is 1, 3R, 12.
 Ⓞ IEC rated only.

Fusible

Non-Fused

Enclosed Fused

Enclosed Non-Fused

Fusible

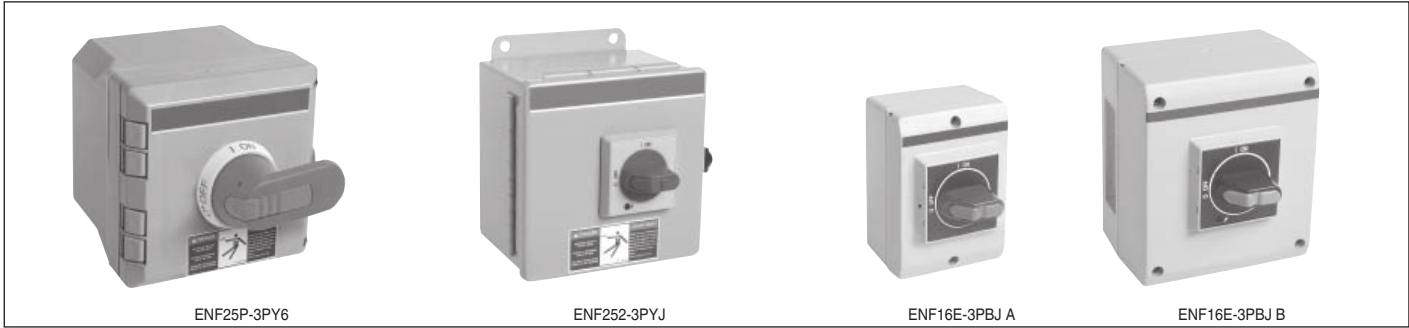

Non-Fused

3 Pole, 600V, 16A – 100A — Selector handle

UL general purpose amp rating	NEMA Enclosure type		IEC Enclosure type
	4X Plastic® Selector handles are only NEMA rated 1, 3R, 12	12	IP65 Plastic
	Catalog number	Catalog number	Catalog number
16	ENF16P-3PBJ	ENF162-3PBJ	ENF16E-3PBJ A or B
25	ENF25P-3PBJ	ENF252-3PBJ	ENF25E-3PBJ
40	ENF32P-3PBJ	ENF322-3PBJ	ENF32E-3PBJ
60	ENF45P-3PBJ	ENF452-3PBJ	ENF45E-3PBJ
80	ENF63P-3PBJ	ENF632-3PBJ	ENF63E-3PBJ

Enclosed Fused

3 Pole, 600V, 16A – 3150A — Pistol handle

UL general purpose amp rating	NEMA Enclosure type		IEC Enclosure type
	4X Plastic	12	IP65 Plastic
	Catalog number	Catalog number	Catalog number
16	ENF16P-3PB6	ENF162-3PB6	ENF16E-3PB4
25	ENF25P-3PB6	ENF252-3PB6	ENF25E-3PB4
40	ENF32P-3PB6	ENF322-3PB6	ENF32E-3PB4
60	ENF45P-3PB6	ENF452-3PB6	ENF45E-3PB4
80	ENF63P-3PB6	ENF632-3PB6	ENF63E-3PB4
30	ENF30P-3PB6	ENF302-3PB6	ENF30E-3PB6
60	ENF60P-3PB6	ENF602-3PB6	ENF60E-3PB6
100	ENF100P-3PB6	ENF1002-3PB6	ENF100E-3PB6
125	ENF125P-3PB6	ENF1252-3PB6	ENF125E-3PB6
200	ENF200P-3PB8B	ENF2002-3PB8B	—
400	ENF400P-3PB4B	ENF4002-3PB4B	—
600	ENF600P-3PB4	ENF6002-3PB4	—
800	ENF800P-3PB4	ENF8002-3PB4	—
1200	ENF1200P-3PB4	ENF12002-3PB4	—
1600	ENF1600P-3P8	ENF16002-3P8	—
2000	ENF2000P-3P8	ENF20002-3P8	—
3150®	ENF3150P-3P8	ENF31502-3P8	—

Enclosed Non-Fused

NOTE: All enclosed switches are provided with a black handle; however, most handles can be substituted with a red and yellow handle if desired. Please substitute the handle suffix code (2nd and 3rd from last characters) with the red/yellow handle catalog number suffix from page 3.12. There is no additional price adder for changing to a red/yellow handle of equal ratings and style.

EXAMPLE: A red/yellow selector handle for an NF161-3PBJA can be substituted for the black selector handle by using the "YJ" suffix instead of the "BJ" suffix, new catalog #NF161-3PYJA.

® Enclosures are rated as listed, selector handles are only NEMA rated 1, 3R, 12. The overall NEMA rating of an enclosed switch with a selector handle is 1, 3R, 12.
 © IEC rated only.

Other Configurations

UL General purpose amp rating	Type of switch	NEMA Enclosure type			
		1	3R	4	4X Stainless
		Catalog number	Catalog number	Catalog number	Catalog number
16	4 Pole	ENF161-4PB6	ENF163-4PB6	ENF164-4PB6	ENF16X-4PB6
	6 Pole	ENF161-6PB6	ENF163-6PB6	ENF164-6PB6	ENF16X-6PB6
	Transfer	ENF161-3TB8	ENF163-3TB8	ENF164-3TB8	ENF16X-3TB8
	Bypass	ENF161-3BB8	ENF163-3BB8	ENF164-3BB8	ENF16X-3BB8
	Mech. interlock	ENF161-3MB6	ENF163-3MB6	ENF164-3MB6	ENF16X-3MB6
25	4 Pole	ENF251-4PB6	ENF253-4PB6	ENF254-4PB6	ENF25X-4PB6
	6 Pole	ENF251-6PB6	ENF253-6PB6	ENF254-6PB6	ENF25X-6PB6
	Transfer	ENF251-3TB8	ENF253-3TB8	ENF254-3TB8	ENF25X-3TB8
	Bypass	ENF251-3BB8	ENF253-3BB8	ENF254-3BB8	ENF25X-3BB8
	Mech. interlock	ENF251-3MB6	ENF253-3MB6	ENF254-3MB6	ENF25X-3MB6
40	4 Pole	ENF321-4PB6	ENF323-4PB6	ENF324-4PB6	ENF32X-4PB6
	6 Pole	ENF321-6PB6	ENF323-6PB6	ENF324-6PB6	ENF32X-6PB6
	Transfer	ENF321-3TB8	ENF323-3TB8	ENF324-3TB8	ENF32X-3TB8
	Bypass	ENF321-3BB8	ENF323-3BB8	ENF324-3BB8	ENF32X-3BB8
	Mech. interlock	ENF321-3MB6	ENF323-3MB6	ENF324-3MB6	ENF32X-3MB6
60	4 Pole	ENF451-4PB6	ENF453-4PB6	ENF454-4PB6	ENF45X-4PB6
	6 Pole	ENF451-6PB6	ENF453-6PB6	ENF454-6PB6	ENF45X-6PB6
	Transfer	ENF451-3TB8	ENF453-3TB8	ENF454-3TB8	ENF45X-3TB8
	Bypass	ENF451-3BB8	ENF453-3BB8	ENF454-3BB8	ENF45X-3BB8
	Mech. interlock	ENF451-3MB6	ENF453-3MB6	ENF454-3MB6	ENF45X-3MB6
80	4 Pole	ENF631-4PB6	ENF633-4PB6	ENF634-4PB6	ENF63X-4PB6
	6 Pole	ENF631-6PB6	ENF633-6PB6	ENF634-6PB6	ENF63X-6PB6
	Transfer	ENF631-3TB8	ENF633-3TB8	ENF634-3TB8	ENF63X-3TB8
	Bypass	ENF631-3BB8	ENF633-3BB8	ENF634-3BB8	ENF63X-3BB8
	Mech. interlock	ENF631-3MB6	ENF633-3MB6	ENF634-3MB6	ENF63X-3MB6
30	4 Pole	ENF301-4PB6	ENF303-4PB6	ENF304-4PB6	ENF30X-4PB6
	6 Pole	ENF301-6PB6	ENF303-6PB6	ENF304-6PB6	ENF30X-6PB6
	Transfer	ENF301-3TB8	ENF303-3TB8	ENF304-3TB8	ENF30X-3TB8
	Bypass	ENF301-3BB8	ENF303-3BB8	ENF304-3BB8	ENF30X-3BB8
	Mech. interlock	ENF301-3MB6	ENF303-3MB6	ENF304-3MB6	ENF30X-3MB6
60	4 Pole	ENF601-4PB6	ENF603-4PB6	ENF604-4PB6	ENF60X-4PB6
	6 Pole	ENF601-6PB6	ENF603-6PB6	ENF604-6PB6	ENF60X-6PB6
	Transfer	ENF601-3TB8	ENF603-3TB8	ENF604-3TB8	ENF60X-3TB8
	Bypass	ENF601-3BB8	ENF603-3BB8	ENF604-3BB8	ENF60X-3BB8
	Mech. interlock	ENF601-3MB6	ENF603-3MB6	ENF604-3MB6	ENF60X-3MB6
100	4 Pole	ENF1001-4PB6	ENF1003-4PB6	ENF1004-4PB6	ENF100X-4PB6
	6 Pole	ENF1001-6PB6	ENF1003-6PB6	ENF1004-6PB6	ENF100X-6PB6
	Transfer	ENF1001-3TB8	ENF1003-3TB8	ENF1004-3TB8	ENF100X-3TB8
	Bypass	ENF1001-3BB8	ENF1003-3BB8	ENF1004-3BB8	ENF100X-3BB8
	Mech. interlock	ENF1001-3MB6	ENF1003-3MB6	ENF1004-3MB6	ENF100X-3MB6
125	2 Pole	ENF1251-2PB6	ENF1253-2PB6	ENF1254-2PB6	ENF125X-2PB6
	4 Pole	ENF1251-4PB6	ENF1253-4PB6	ENF1254-4PB6	ENF125X-4PB6
	6 Pole	ENF1251-6PB2	ENF1253-6PB2	ENF1254-6PB4	ENF125X-6PB4
	Transfer	ENF1251-3TB8	ENF1253-3TB8	ENF1254-3TB8	ENF125X-3TB8
	Mech. interlock	ENF1251-3MB6	ENF1253-3MB6	ENF1254-3MB8	ENF125X-3MB8
200	4 Pole	ENF2001-4PB8B	ENF2003-4PB8B	ENF2004-4PB8B	ENF200X-4PB8B
	6 Pole	ENF2001-6PB4B	ENF2003-6PB4B	ENF2004-6PB4B	ENF200X-6PB4B
	Transfer	ENF2001-3TB4B	ENF2003-3TB4B	ENF2004-3TB4B	ENF200X-3TB4B
	Bypass	—	—	—	—
	Mech. interlock	ENF2001-3MB8B	ENF2003-3MB8B	ENF2004-3MB8B	ENF200X-3MB8B
400	4 Pole	ENF4001-4PB4B	ENF4003-4PB4B	ENF4004-4PB4B	ENF400X-4PB4B
	6 Pole	ENF4001-6PB8B	ENF4003-6PB8B	ENF4004-6PB8B	ENF400X-6PB8B
	Transfer	ENF4001-3TB4B	ENF4003-3TB4B	ENF4004-3TB4B	ENF400X-3TB4B
	Bypass	ENF4001-3PB6B	ENF4003-3PB6B	ENF4004-3PB6B	ENF400X-3PB6B
	Mech. interlock	ENF4001-3MB4B	ENF4003-3MB4B	ENF4004-3MB4B	ENF400X-3MB4B

Fusible
Non-Fused
Enclosed Fused
Enclosed Non-Fused

Other Configurations

	UL General purpose amp rating	Type of switch	NEMA Enclosure type		IEC Enclosure type
			4X Plastic	12	IP65
			Catalog number	Catalog number	Catalog number
Fusible	16	4 pole	ENF16P-4PB6	ENF162-4PB6	ENF16E-4PBJ
		6 pole	ENF16P-6PB6	ENF162-6PB6	ENF16E-6PBJ
		Transfer	ENF16P-3TB8	ENF162-3TB8	—
Non-Fused	25	Bypass	ENF16P-3BB8	ENF162-3BB8	—
		Mech. interlock	ENF16P-3MB6	ENF162-3MB6	—
		4 pole	ENF25P-4PB6	ENF252-4PB6	ENF25E-4PBJ
Enclosed Fused	40	6 pole	ENF25P-6PB6	ENF252-6PB6	ENF25E-6PBJ
		Transfer	ENF25P-3TB8	ENF252-3TB8	—
		Bypass	ENF25P-3BB8	ENF252-3BB8	—
Enclosed Non-Fused	60	Mech. interlock	ENF25P-3MB6	ENF252-3MB6	—
		4 Pole	ENF32P-4PB6	ENF322-4PB6	ENF32E-4PBJ
		6 Pole	ENF32P-6PB6	ENF322-6PB6	ENF32E-6PBJ
Enclosed Fused	80	Transfer	ENF32P-3TB8	ENF322-3TB8	—
		Bypass	ENF32P-3BB8	ENF323-3BB8	—
		Mech. interlock	ENF32P-3MB6	ENF322-3MB6	—
Enclosed Non-Fused	30	4 Pole	ENF45P-4PB6	ENF452-4PB6	ENF45E-4PBJ
		6 Pole	ENF45P-6PB6	ENF452-6PB6	ENF45E-6PBJ
		Transfer	ENF45P-3TB8	ENF452-3TB8	—
Enclosed Fused	60	Bypass	ENF45P-3BB8	ENF452-3BB8	—
		Mech. interlock	ENF45P-3MB6	ENF452-3MB6	—
		4 Pole	ENF63P-4PB6	ENF632-4PB6	ENF63E-4PBJ
Enclosed Non-Fused	100	6 Pole	ENF63P-6PB6	ENF632-6PB6	ENF637-6PBJ
		Transfer	ENF63P-3TB8	ENF632-3TB8	—
		Bypass	ENF63P-3BB8	ENF632-3BB8	—
Enclosed Fused	125	Mech. interlock	ENF63P-3MB6	ENF632-3MB6	—
		4 Pole	ENF30P-4PB6	ENF302-4PB6	ENF30E-4PB4
		6 Pole	ENF30P-6PB6	ENF302-6PB6	ENF30E-6PB6
Enclosed Non-Fused	200	Transfer	ENF30P-3TB8	ENF302-3TB8	—
		Bypass	ENF30P-3BB8	ENF302-3BB8	—
		Mech. interlock	ENF30P-3MB6	ENF302-3MB6	—
Enclosed Fused	400	4 Pole	ENF60P-4PB6	ENF602-4PB6	ENF60E-4PB4
		6 Pole	ENF60P-6PB6	ENF602-6PB6	ENF60E-6PB6
		Transfer	ENF60P-3TB8	ENF602-3TB8	—
Enclosed Non-Fused	100	Bypass	ENF60P-3BB8	ENF602-3BB8	—
		Mech. interlock	ENF60P-3MB6	ENF602-3MB6	—
		4 Pole	ENF100P-4PB6	ENF1002-4PB6	ENF100E-4PB4
Enclosed Fused	125	6 Pole	ENF100P-6PB6	ENF1002-6PB6	ENF100E-6PB6
		Transfer	ENF100P-3TB8	ENF1002-3TB8	—
		Bypass	ENF100P-3BB8	ENF1002-3BB8	—
Enclosed Non-Fused	200	Mech. interlock	ENF100P-3MB6	ENF1002-3MB6	—
		2 Pole	ENF125P-2PB6	ENF1252-2PB6	—
		4 Pole	ENF125P-4PB6	ENF1252-4PB6	—
Enclosed Fused	400	6 Pole	ENF125P-6PB2	ENF1252-6PB2	—
		Transfer	ENF125P-3TB8	ENF1252-3TB8	—
		Bypass	—	—	—
Enclosed Non-Fused	200	Mech. interlock	ENF125P-3MB6	ENF1252-3MB6	—
		4 Pole	ENF200P-4PB8B	ENF2002-4PB8B	—
		6 Pole	ENF200P-6PB4B	ENF2002-6PB4B	—
Enclosed Fused	400	Transfer	ENF200P-3TB4B	ENF2002-3TB4B	—
		Bypass	—	—	—
		Mech. interlock	ENF200P-3MB8B	ENF2002-3MB8B	—
Enclosed Non-Fused	400	4 Pole	ENF400P-4PB4B	ENF4002-4PB4B	—
		6 Pole	ENF400P-6PB8B	ENF4002-6PB8B	—
		Transfer	ENF400P-3TB4B	ENF4002-3TB4B	—
Enclosed Fused	400	Bypass	ENF400P-3BB6B	ENF4002-3BB6B	—
		Mech. interlock	ENF400P-3MB4B	ENF4002-3MB4B	—

Other Configurations

UL General purpose amp rating	Type of switch	NEMA Enclosure type			
		1	3R	4	4X Stainless
		Catalog number	Catalog number	Catalog number	Catalog number
600	2 Pole	ENF6001-2PB4	ENF6003-2PB4	ENF6004-2PB4	ENF600X-2PB4
	4 Pole	ENF6001-4PB4	ENF6003-4PB4	ENF6004-4PB4	ENF600X-4PB4
	6 Pole	ENF6001-6P8	ENF6003-6P8	ENF6004-6P8	ENF600X-6P8
	Transfer	ENF6001-3TB4	ENF6003-3TB4	ENF6004-3TB4	ENF600X-3TB4
	Bypass	ENF6001-3B6	ENF6003-3B6	ENF6004-3B6	ENF600X-3B6
	Mech. interlock	ENF6001-3MB4	ENF6003-3MB4	ENF6004-3MB4	ENF600X-3MB4
800	2 Pole	ENF8001-2PB4	ENF8003-2PB4	ENF8004-2PB4	ENF800X-2PB4
	4 Pole	ENF8001-4PB4	ENF8003-4PB4	ENF8004-4PB4	ENF800X-4PB4
	6 Pole	ENF8001-6P8	ENF8003-6P8	ENF8004-6P8	ENF800X-6P8
	ransfer	ENF8001-3TB4	ENF8003-3TB4	ENF8004-3TB4	ENF800X-3TB4
	Bypass	ENF8001-3B6	ENF8003-3B6	ENF8004-3B6	ENF800X-3B6
	Mech. interlock	ENF8001-3MB4	ENF8003-3MB4	ENF8004-3MB4	ENF800X-3MB4
1200	2 Pole	ENF12001-2PB4	ENF12003-2PB4	ENF12004-2PB4	ENF1200X-2PB4
	4 Pole	ENF12001-4PB4	ENF12003-4PB4	ENF12004-4PB4	ENF1200X-4PB4
	6 Pole	ENF12001-6P8	ENF12003-6P8	ENF12004-6P8	ENF12001-6P8
	Transfer	ENF12001-3TB4	ENF12003-3TB4	ENF12004-3TB4	ENF1200X-3TB4
	Bypass	ENF12001-3B6	ENF12003-3B6	ENF12004-3B6	ENF1200X-3B6
	Mech. interlock	ENF12001-3MB4	ENF12003-3MB4	ENF12004-3MB4	ENF1200X-3MB4
1600	2 Pole	ENF16001-2P8	ENF16003-2P8	ENF16004-2P8	ENF1600X-2P8
	4 Pole	ENF16001-4P8	ENF16003-4P8	ENF16004-4P8	ENF1600X-4P8
	6 Pole	—	—	—	—
	Transfer	—	—	—	—
	Bypass	—	—	—	—
	Mech. interlock	—	—	—	—
2000	2 Pole	ENF20001-2P8	ENF20003-2P8	ENF20004-2P8	ENF2000X-2P8
	4 Pole	ENF20001-4P8	ENF20003-4P8	ENF20004-4P8	ENF2000X-4P8
	6 Pole	—	—	—	—
	Transfer	—	—	—	—
	Bypass	—	—	—	—
	Mech. interlock	—	—	—	—
3150	2 Pole	ENF31501-2P8	ENF31503-2P8	ENF31504-2P8	ENF3150X-2P8
	4 Pole	ENF31501-4P8	ENF31503-4P8	ENF31504-4P8	ENF3150X-4P8
	6 Pole	—	—	—	—
	Transfer	—	—	—	—
	Bypass	—	—	—	—
	Mech. interlock	—	—	—	—

Fusible
Non-Fused
Enclosed Fused
Enclosed Non-Fused

① IEC rated only.

Other Configurations

UL General purpose amp rating	Type of switch	NEMA Enclosure type		
		4X Plastic	12	7 & 9
		Catalog number	Catalog number	Catalog number
600	2 Pole	ENF600P-2PB4	ENF6002-2PB4	ENF6007-2P
	4 Pole	ENF600P-4PB4	ENF6002-4PB4	ENF6007-4P
	6 Pole	ENF600P-6P8	ENF6002-6P8	ENF6007-6P
	Transfer	ENF600P-3TB4	ENF6002-3TB4	ENF6007-3T
	Bypass	ENF600P-3B6	ENF6002-3B6	ENF6007-3B
	Mech. interlock	ENF600P-3MB4	ENF6002-3MB4	—
800	2 pole	ENF800P-2PB4	ENF8002-2PB4	ENF8007-2P
	4 pole ^①	ENF800P-4PB4	ENF8002-4PB4	ENF8007-4P
	6 pole	ENF800P-6P8	ENF8002-6PB4	ENF8007-6P
	Transfer	ENF800P-3TB4	ENF8002-3TB4	ENF8007-3T
	Bypass	ENF800P-3B6	ENF8002-3B6	ENF8007-3B
	Mech. interlock	ENF800P-3MB4	ENF8002-3MB4	—
1200	2 Pole	ENF1200P-2PB4	ENF12002-2PB4	ENF12007-2P
	4 Pole ^①	ENF1200P-4PB4	ENF12002-4PB4	ENF12007-4P
	6 Pole	ENF1200P-6P8	ENF12003-6PB4	ENF12007-6P
	Transfer	ENF1200P-3TB4	ENF12002-3TB4	ENF12007-3T
	Bypass	ENF1200P-3B6	ENF12002-3B6	ENF12007-3B
	Mech. interlock	ENF1200P-3MB4	ENF12002-3MB4	—
1600	2 Pole	ENF1600P-2P8	ENF16002-2P8	—
	4 Pole ^①	ENF1600P-4P8	ENF16002-4P8	②
	6 Pole	—	—	—
	Transfer	—	—	—
	Bypass	—	—	—
	Mech. interlock	—	—	—
2000	2 Pole	ENF2000P-2P8	ENF20002-2P8	—
	4 Pole ^①	ENF2000P-4P8	ENF20002-4P8	②
	6 Pole	—	—	—
	Transfer	—	—	—
	Bypass	—	—	—
	Mech. interlock	—	—	—
3150 ^①	2 Pole ^①	ENF3150P-2P8	ENF31502-2P8	—
	4 Pole ^①	ENF3150P-4P8	ENF31502-4P8	②
	6 Pole	—	—	—
	Transfer	—	—	—
	Bypass	—	—	—
	Mech. interlock	—	—	—

Fusible

Non-Fused

Enclosed Fused

Enclosed Non-Fused

① IEC rated only.
② Consult factory for price and availability.

Accessories for Enclosed Non-Fusible Disconnect Switches



Other Configurations

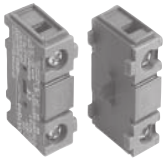

CDAUX_ _

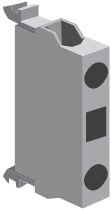

CDAUXCA_ _

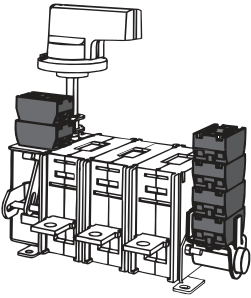

BDAUX_ _



3 Position selector switch



Pilot light

Auxiliary contacts

For use on:	Contact configuration	Catalog number	Installation suffix
16A – 100A	1 N.O.	CDAUX10	add "10" suffix
	1 N.C.	CDAUX01	add "01" suffix
125A	1 N.O.	CDAUXCA10	add "10" suffix
	1 N.C.	CDAUXCA01	add "01" suffix
200A-400A	1 N.O.	CDAUX10	add "10" suffix
	1 N.C.	CDAUX01K	add "01" suffix
600A –800A	1 N.O. & 1 N.C.	BDAUX1	add "11" suffix
	2 N.O. & 2 N.C.	BDAUX2	add "22" suffix

Accessories

For use on:	Contact configuration	Installation suffix
16, 25, 40A	Neutral or isolated ground block	N or G
40A – 60A	Neutral or isolated ground block	N or G
80A – 100A	Neutral or isolated ground block	N or G
125A	Neutral or isolated ground block	N or G
200A – 1200A	Neutral block	N
1600A – 3150A	Neutral block	N
16A – 30A	Switched neutral block	S
40A – 60A	Switched neutral block	S
80A – 100A	Switched neutral block	S
125A	Switched neutral block	S
80A – 1200A	Service entrance, 3 wire	U
80A – 1200A	Service entrance, 4 wire	V
16A – 3150A	Start/stop pushbuttons	A
	2 position selector switch	C
	3 position selector switch	D
	Pilot light "red/run"	E
	Ammeter 1 phase	AM
	Voltmeter	VM

Ground lugs

All enclosed switches are provided with a standard integral ground lug.

Switch size	Ground lug Wire size
16A – 100A	(2) #14
200A – 400A	#6 – 250 mcm
600A – 1200A	#2 – 600 mcm
2000A – 3150A	(2) #2 – 600 mcm

Fusible

Non-Fused

Enclosed Fused

Enclosed Non-Fused

Switch ratings, 16 – 3150 Amps, 600V

UL General purpose amp rating	Maximum horsepower rating							Wire size for terminal lugs	For wire type	Approval	
	Single phase			Three phase							
	120V	200V	240V	200V – 208V	240V	480V	600V				
UL 508 ↑ 16 25 40 60 80 ↓	16	1/2	1.5	1.5	3	5	10	10	#18 – 8	Cu	cULus, UL ^①
	25	3/4	2	2	7.5	7.5	15	20	#18 – 8	Cu	cULus, UL ^①
	40	1	3	3	10	10	20	25	#18 – 8	Cu	cULus, UL ^①
	60	2	5	5	15	15	30	30	#14 – 1	Cu	cULus, UL ^①
	80	2	5	5	20	20	40	50	#14 – 1	Cu	cULus, UL ^①
UL 98 ↑ 30 60 100 125 200 400 600 800 1200 1600 2000 3150 ^③ ↓	30	2	5	5	10	10	20	30	#14 – 4	Cu	cULus, UL ^②
	60	3	7.5	7.5	20	20	40	40	#14 – 4	Cu	cULus, UL ^②
	100	5	15	15	25	25	50	40	#8 – 1/0	Cu	cULus, UL ^②
	125	7.5	20	20	30	30	60	75	#8 – 1/0	Cu	cULus, UL ^②
	200	—	—	—	60	75	150	200	#6 – 300 kcmil	Cu	cULus, UL ^②
	400	—	—	—	100	125	250	350	#2 – 600 kcmil	Cu	cULus, UL ^②
	600	—	—	—	150	200	400	500	(2) #2 – 600 kcmil	Cu	cULus, UL ^②
	800	—	—	—	200	250	500	600	(2) #2 – 600 kcmil	Cu/Al	cULus, UL ^②
	1200	—	—	—	—	—	—	—	(4) #2 – 600 kcmil	Cu/Al	cULus, UL ^②
	1600	—	—	—	—	—	—	—	(4) #2 – 600 kcmil	Cu/Al	cULus, UL ^②
2000	—	—	—	—	—	—	—	(8) #2 – 600 kcmil	Cu/Al	cULus, UL ^②	
3150 ^③	—	—	—	—	—	—	—	(8) #2 – 600 kcmil	Cu/Al	IEC	

Handle ratings, 16 – 3150 Amps, 600V

Amperage range	Style type	NEMA	Color	Marking	Defeatable	Padlockable	Catalog number suffix	Catalog number
16 – 100	Selector	1,3R,12	Black	0/I & OFF/ON	Yes	Yes	BJ	CDH5S
	Selector	1,3R,12	Red/Yel	0/I & OFF/ON	Yes	Yes	YJ	CDH6S
	Pistol	1,3R,12	Black	0/I & OFF/ON	Yes	Yes	B6	BDH106
	Pistol	1,3R,12	Red/Yel	0/I & OFF/ON	Yes	Yes	Y6	BDH107
	Pistol	1,3R,4,4X,12	Black	0/I & OFF/ON	Yes	Yes	B6	CDHXB65
	Pistol	1,3R,4,4X,12	Red/Yel	0/I & OFF/ON	Yes	Yes	Y6	CDHXY65
125	Pistol	1,3R,12	Black	0/I & OFF/ON	Yes	Yes	B6	BDH120
	Pistol	1,3R,12	Red/Yel	0/I & OFF/ON	Yes	Yes	Y6	BDH121
	Pistol	1,3R,4,4X,12	Black	0/I & OFF/ON	Yes	Yes	B8	CDHXB86
	Pistol	1,3R,4,4X,12	Red/Yel	0/I & OFF/ON	Yes	Yes	Y8	CDHXY86
200	Pistol	1,3R,12	Black	0/I & OFF/ON	Yes	Yes	B8	BDH60
	Pistol	1,3R,12	Red/Yel	0/I & OFF/ON	Yes	Yes	Y8	BDH61
	Pistol	1,3R,4,4X,12	Black	0/I & OFF/ON	Yes	Yes	B8	CDHXB86
	Pistol	1,3R,4,4X,12	Red/Yel	0/I & OFF/ON	Yes	Yes	Y8	CDHXY86
400 – 3150	Pistol	1,3R,12	Black	0/I & OFF/ON	Yes	Yes	B4	BDH114
	Pistol	1,3R,12	Red/Yel	0/I & OFF/ON	Yes	Yes	Y4	BDH115
	Pistol	1,3R,12	Black	0/I & OFF/ON	Yes	Yes	B7	BDH116
	Pistol	1,3R,12	Red/Yel	0/I & OFF/ON	Yes	Yes	Y7	BDH117
	Pistol	1,3R,4,4X,12	Black	0/I & OFF/ON	Yes	Yes	B4	CDHXB12
	Pistol	1,3R,4,4X,12	Red/Yel	0/I & OFF/ON	Yes	Yes	Y4	CDHXY12
	Pistol	1,3R,4,4X,12	Black	0/I & OFF/ON	Yes	Yes	B7	CDHXB22
	Pistol	1,3R,4,4X,12	Red/Yel	0/I & OFF/ON	Yes	Yes	Y7	CDHXY22
	Pistol	1,3R,4,4X,12	Metal	0/I & OFF/ON	No	Yes	8	BDH8

① UL Listed (UL508).
 ② UL Listed (UL98).
 ③ IEC rated only.

Approximate Dimensions for Enclosed Non-Fusible Disconnect Switches



2, 3 & 4 Pole Non-fusible switches

Frame Size	Enclosure type	H Height	W Width	D Depth	MH Mtg Height	MW Mtg Width	Weight
CDNF16 CDNF25 CDNF32	1	7.0	5.0	3.0	4.0	4.0	4.0
	3R	7.0	5.0	3.0	7.75	3.0	4.0
	4	6.0	6.0	4.0	6.75	4.0	4.0
	4X SS	7.0	5.0	3.0	7.75	3.0	4.0
	4X Plastic	6.0	6.0	5.9	6.75	4.0	4.0
	12	7.0	5.0	3.0	7.75	3.0	4.0
	IP65 (A)	4.8	3.4	2.4	4.17	2.80	1.0
IP65 (B)	5.9	5.1	2.4	5.35	4.57	1.0	
CDNF45 CDNF63 CDNF30 CDNF60	1	8.0	6.0	4.0	7.0	5.0	6.0
	3R	8.0	6.0	4.0	8.75	4.0	6.0
	4	8.0	6.0	4.0	8.75	4.0	6.0
	4X SS	8.0	6.0	4.0	8.75	4.0	6.0
	4X Plastic	8.0	6.0	5.9	8.75	4.0	6.0
	12	8.0	6.0	4.0	8.75	4.0	6.0
	IP65 (A)	7.9	5.7	3.6	7.24	5.16	4.0
IP65 (B)	15.8	7.9	5.5	14.8	6.93	4.0	
CDNF100	1	10.0	8.0	5.0	7.0	7.0	9.0
	3R	10.0	8.0	5.0	10.75	6.0	9.0
	4	10.0	8.0	4.0	10.75	6.0	9.0
	4X SS	10.0	8.0	5.0	10.75	6.0	9.0
	4X Plastic	10.0	8.0	5.9	10.75	6.0	9.0
	12	10.0	8.0	5.0	10.75	6.0	9.0
	IP65 (A)	7.9	5.7	3.6	7.24	5.16	4.0
IP65 (B)	15.8	7.9	5.5	14.8	6.93	4.0	
CDNF160	1	14.0	12.0	8.0	11.0	9.0	20
	3R	14.0	12.0	8.0	14.75	10.0	20
	4	14.0	12.0	6.0	14.75	10.0	20
	4X SS	14.0	12.0	8.0	14.75	10.0	20
	4X Plastic	14.0	12.0	5.9	14.75	10.0	12
	12	14.0	12.0	8.0	14.75	10.0	20
	IP65 (A)	14.0	12.0	8.0	14.75	10.0	20
IP65 (B)	14.0	12.0	8.0	14.75	10.0	20	
CDNF200	1	20.00	16.00	6.00	21.50	14.50	50.00
	3R	20.00	16.00	6.00	21.50	14.50	50.00
	4	20.00	16.00	6.00	21.50	14.50	50.00
	4X SS	20.00	16.00	6.00	21.50	14.50	50.00
	4X Plastic	24.00	16.00	10.00	25.50	14.50	40.00
	12	20.00	16.00	6.00	21.50	14.50	50.00
	IP65 (A)	20.00	16.00	6.00	21.50	14.50	50.00
IP65 (B)	20.00	16.00	6.00	21.50	14.50	50.00	
CDNF400 BDNF600	1	36.00	24.00	8.000	37.50	22.50	120.00
	3R	36.00	24.00	8.000	37.50	22.50	120.00
	4	36.00	24.00	8.000	37.50	22.50	120.00
	4X SS	36.00	24.00	8.000	37.50	22.50	130.00
	4X Plastic	39.31	30.60	13.80	38.00	24.00	1.00
	12	36.00	24.00	8.000	37.50	22.50	120.00
	IP65 (A)	36.00	24.00	8.000	37.50	22.50	120.00
IP65 (B)	36.00	24.00	8.000	37.50	22.50	120.00	
BDNF800 BDNF1200	1	60.00	36.00	12.00	61.50	34.50	200.00
	3R	60.00	36.00	12.00	61.50	34.50	200.00
	4	60.00	36.00	12.00	61.50	34.50	200.00
	4X SS	60.00	36.00	12.00	61.50	34.50	200.00
	4X Plastic	60.00	36.00	12.00	61.50	34.50	200.00
	12	60.00	36.00	12.00	61.50	34.50	200.00
	IP65 (A)	60.00	36.00	12.00	61.50	34.50	200.00
IP65 (B)	60.00	36.00	12.00	61.50	34.50	200.00	

6 Pole Non-fusible Enclosed switches

Frame Size	Enclosure type	H Height	W Width	D Depth	MH Mtg Height	MW Mtg Width	Weight
CDNF16 CDNF15 CDNF32	1	8.0	6.0	4.0	7.00	5.0	6.0
	3R	8.0	6.0	4.0	8.75	4.0	6.0
	4	8.0	6.0	4.0	8.75	4.0	6.0
	4X SS	8.0	6.0	4.0	8.75	4.0	6.0
	4X Plastic	6.0	6.0	5.9	8.75	4.0	6.0
	12	8.0	6.0	4.0	8.75	4.0	6.0
	IP65 (A)	7.9	5.7	3.6	7.24	5.16	4.0
IP65 (B)	15.8	7.9	5.5	14.8	6.93	4.0	
CDNF45 CDNF63	1	10.0	8.0	5.0	7.0	7.0	6.0
	3R	10.0	8.0	5.0	10.75	6.0	6.0
	4	10.0	8.0	6.0	10.75	6.0	6.0
	4X SS	10.0	8.0	5.0	10.75	6.0	6.0
	4X Plastic	10.0	8.0	7.9	10.75	6.0	6.0
	12	10.0	8.0	5.0	10.75	6.0	6.0
	IP65 (A)	7.9	5.7	4.0	7.18	5.1	1.5
IP65 (B)	—	—	—	—	—	—	
CDNF30 CDNF60 CDNF100	1	10.0	8.0	5.0	7.0	7.0	9.0
	3R	10.0	8.0	5.0	10.75	6.0	9.0
	4	10.0	8.0	6.0	10.75	6.0	9.0
	4X SS	10.0	8.0	5.0	10.75	6.0	9.0
	4X Plastic	10.0	8.0	7.9	00.00	0.0	9.0
	12	10.0	8.0	5.0	0.0	6.0	9.0
	IP65 (A)	—	—	—	—	—	—
IP65 (B)	—	—	—	—	—	—	
CDNF160	1	16.0	6.0	6.0	17.50	14.5	20
	3R	16.0	6.0	6.0	17.50	14.5	20
	4	16.0	6.0	6.0	17.50	14.5	20
	4X SS	16.0	6.0	6.0	17.50	14.5	20
	4X Plastic	16.0	14.0	8.0	16.75	12.0	20
	12	16.0	6.0	6.0	17.50	14.5	20
	IP65 (A)	16.0	6.0	6.0	17.50	14.5	20
IP65 (B)	16.0	6.0	6.0	17.50	14.5	20	
CDNF200	1	20.0	20.0	8.0	21.50	18.5	60
	3R	20.0	20.0	8.0	21.50	18.5	60
	4	20.0	20.0	8.0	21.50	18.5	60
	4X SS	20.0	20.0	8.0	21.50	18.5	60
	4X Plastic	24.0	20.0	10.0	25.50	18.0	60
	12	20.0	20.0	8.0	21.50	18.5	60
	IP65 (A)	20.0	20.0	8.0	21.50	18.5	60
IP65 (B)	20.0	20.0	8.0	21.50	18.5	60	
CDNF400 BDNF600	1	36.00	30.00	8.0	37.50	28.50	160.00
	3R	36.00	30.00	8.0	37.50	28.50	160.00
	4	36.00	30.00	8.0	37.50	28.50	160.00
	4X SS	36.00	30.00	8.0	37.50	28.50	160.00
	4X Plastic	⊖	⊖	⊖	⊖	⊖	⊖
	12	36.00	30.00	8.0	37.50	28.50	160.00
	IP65 (A)	36.00	30.00	8.0	37.50	28.50	160.00
IP65 (B)	36.00	30.00	8.0	37.50	28.50	160.00	
BDNF800 BDNF1200	1	60.00	36.00	12.00	61.50	34.50	240.00
	3R	60.00	36.00	12.00	61.50	34.50	240.00
	4	60.00	36.00	12.00	61.50	34.50	240.00
	4X SS	60.00	36.00	12.00	61.50	34.50	240.00
	4X Plastic	⊖	⊖	⊖	⊖	⊖	⊖
	12	60.00	36.00	12.00	61.50	34.50	240.00
	IP65 (A)	60.00	36.00	12.00	61.50	34.50	240.00
IP65 (B)	60.00	36.00	12.00	61.50	34.50	240.00	
BDNF1600 BDNF2000 BDNF3150	1	90.00	36.00	24.00	2.000	34.50	600.00
	3R	90.00	36.00	24.00	2.000	34.50	600.00
	4	⊖	⊖	⊖	⊖	⊖	⊖
	4X SS	⊖	⊖	⊖	⊖	⊖	⊖
	4X Plastic	⊖	⊖	⊖	⊖	⊖	⊖
	12	90.00	36.00	24.00	2.000	34.50	600.00
	IP65 (A)	90.00	36.00	24.00	2.000	34.50	600.00
IP65 (B)	90.00	36.00	24.00	2.000	34.50	600.00	

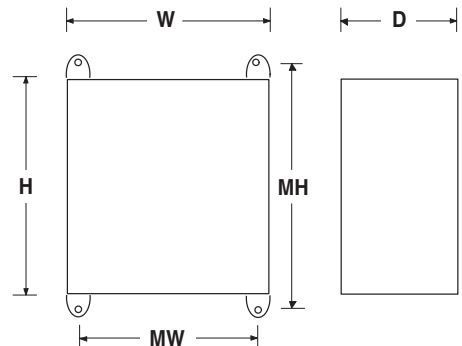

1 Please consult factory.
2 Enclosure is free standing.
3 Some 4-pole switches require larger enclosures. Please consult factory.

Fusible

Non-Fused

Enclosed Fused

Enclosed Non-Fused

Fusible

Non-Fusible

Enclosed Fusible

Enclosed Non-Fusible

Mechanical Interlock for Non-Fusible Enclosed

Frame Size	Enclosure type	H Height	W Width	D Depth	MH Mtg Height	MW Mtg Width	Weight
CDNF16 CDNF15 CDNF32	1	10.0	8.0	6.0	10.8	6.0	4.0
	3R	10.0	8.0	6.0	10.8	6.0	4.0
	4	10.0	8.0	6.0	10.8	6.0	4.0
	4X SS	10.0	8.0	6.0	10.8	6.0	4.0
	4X Plastic	10.0	8.0	6.0	10.8	6.0	4.0
	12	10.0	8.0	6.0	10.8	6.0	4.0
	IP65 (A)	5.9	5.1	3.4	5.35	4.57	1.2
	IP65 (B)	—	—	—	—	—	—
CDNF45 CDNF63	1	10.00	8.00	5.00	7.00	7.00	6.0
	3R	10.00	8.00	5.00	10.75	6.00	6.0
	4	10.00	8.00	6.00	10.75	6.00	6.0
	4X SS	10.00	8.00	5.00	10.75	6.00	6.0
	4X Plastic	10.00	8.00	7.90	10.75	6.00	6.0
	12	10.00	8.00	5.00	10.75	6.00	6.0
	IP65 (A)	7.9	5.7	4.0	7.18	5.10	1.5
	IP65 (B)	—	—	—	—	—	—
CDNF30 CDNF60 CDNF100	1	10.0	8.0	5.0	7.0	7.0	9.0
	3R	10.0	8.0	5.0	10.75	6.0	9.0
	4	10.0	8.0	6.0	10.75	6.0	9.0
	4X SS	10.0	8.0	5.0	10.75	6.0	9.0
	4X Plastic	10.0	8.0	7.9	00.00	0.0	9.0
	12	10.0	8.0	5.0	0.0	6.0	9.0
	IP65 (A)	—	—	—	—	—	—
	IP65 (B)	—	—	—	—	—	—
CDNF160	1	14.0	12.0	8.0	10.00	9.0	20
	3R	14.0	12.0	8.0	14.75	10.5	20
	4	14.0	12.0	8.0	14.75	10.5	20
	4X SS	14.0	12.0	8.0	14.75	10.5	20
	4X Plastic	14.0	12.0	8.0	00.00	0.0	20
	12	14.0	12.0	8.0	14.75	10.5	20
CDNF200	1	20.0	20.0	8.0	21.50	18.5	60
	3R	20.0	20.0	8.0	21.50	18.5	60
	4	20.0	20.0	8.0	21.50	18.5	60
	4X SS	20.0	20.0	8.0	21.50	18.5	60
	4X Plastic	24.0	20.0	10.0	25.50	18.0	60
	12	20.0	20.0	8.0	21.50	18.5	60
CDNF400 BDNF600	1	36.00	30.00	8.000	37.50	28.50	160.00
	3R	36.00	30.00	8.000	37.50	28.50	160.00
	4	36.00	30.00	8.000	37.50	28.50	160.00
	4X SS	36.00	30.00	8.000	37.50	28.50	160.00
	4X Plastic	⊕	⊕	⊕	⊕	⊕	⊕
	12	36.00	30.00	8.000	37.50	28.50	160.00
BDNF800 BDNF1200	1	60.00	36.00	12.00	61.50	34.50	240.00
	3R	60.00	36.00	12.00	61.50	34.50	240.00
	4	60.00	36.00	12.00	61.50	34.50	240.00
	4X SS	60.00	36.00	12.00	61.50	34.50	240.00
	4X Plastic	⊕	⊕	⊕	⊕	⊕	⊕
	12	60.00	36.00	12.00	61.50	34.50	240.00
BDNF1600 BDNF2000 BDNF3150	1	90.00	36.00	24.00	2.000	34.50	600.00
	3R	90.00	36.00	24.00	2.000	34.50	600.00
	4	⊕	⊕	⊕	⊕	⊕	⊕
	4X SS	⊕	⊕	⊕	⊕	⊕	⊕
	4X Plastic	⊕	⊕	⊕	⊕	⊕	⊕
	12	90.00	36.00	24.00	⊕	⊕	600.00

Transfer Switches for Non-Fusible Enclosed

Frame Size	Enclosure type	H Height	W Width	D Depth	MH Mtg Height	MW Mtg Width	Weight
CDNF16 CDNF15 CDNF32	1	8.0	6.0	4.0	3.0	5.0	4.0
	3R	8.0	6.0	4.0	6.75	4.0	4.0
	4	8.0	6.0	4.0	6.75	4.0	4.0
	4X SS	8.0	6.0	4.0	7.75	4.0	4.0
	4X Plastic	8.0	6.0	5.9	6.75	4.0	4.0
	12	8.0	6.0	4.0	6.75	4.0	4.0
	IP65 (A)	—	—	—	—	—	—
	IP65 (B)	—	—	—	—	—	—
CDNF45 CDNF63	1	14.0	12.0	8.0	7.00	7.0	6.0
	3R	14.0	12.0	8.0	10.75	6.0	6.0
	4	14.0	12.0	8.0	10.75	6.0	6.0
	4X SS	14.0	12.0	8.0	10.75	6.0	6.0
	4X Plastic	14.0	12.0	8.0	10.75	6.0	6.0
	12	14.0	12.0	8.0	10.75	6.0	6.0
	IP65 (A)	—	—	—	—	—	—
	IP65 (B)	—	—	—	—	—	—
CDNF30 CDNF60 CDNF100	1	14.0	12.0	8.0	14.75	10.0	9.0
	3R	14.0	12.0	8.0	14.75	10.0	9.0
	4	14.0	12.0	8.0	14.75	10.0	9.0
	4X SS	14.0	12.0	8.0	14.75	10.0	9.0
	4X Plastic	14.0	12.0	8.0	16.75	12.0	9.0
	12	14.0	12.0	8.0	14.75	10.0	9.0
	IP65 (A)	—	—	—	—	—	—
	IP65 (B)	—	—	—	—	—	—
CDNF160	1	20.0	16.0	6.0	21.50	14.5	20
	3R	20.0	16.0	6.0	21.50	14.5	20
	4	20.0	16.0	6.0	21.50	14.5	20
	4X SS	20.0	16.0	6.0	24.50	14.5	20
	4X Plastic	—	—	—	—	—	—
	12	20.0	16.0	6.0	24.50	14.5	20
CDNF200	1	20.0	20.0	8.0	21.50	18.5	20
	3R	20.0	20.0	8.0	21.50	18.5	20
	4	20.0	20.0	8.0	21.50	18.5	20
	4X SS	20.0	20.0	8.0	21.50	18.5	20
	4X Plastic	24.0	20.0	10.0	25.50	18.0	60
	12	20.0	20.0	8.0	21.50	18.5	20
CDNF400 BDNF600	1	36.00	30.00	8.000	37.50	28.50	160.00
	3R	36.00	30.00	8.000	37.50	28.50	160.00
	4	36.00	30.00	8.000	37.50	28.50	160.00
	4X SS	36.00	30.00	8.000	37.50	28.50	160.00
	4X Plastic	⊕	⊕	⊕	⊕	⊕	⊕
	12	36.00	30.00	8.000	37.50	28.50	160.00
BDNF800 BDNF1200	1	60.00	36.00	12.00	61.50	34.50	240.00
	3R	60.00	36.00	12.00	61.50	34.50	240.00
	4	60.00	36.00	12.00	61.50	34.50	240.00
	4X SS	60.00	36.00	12.00	61.50	34.50	240.00
	4X Plastic	⊕	⊕	⊕	⊕	⊕	⊕
	12	60.00	36.00	12.00	61.50	34.50	240.00
BDNF1600 BDNF2000 BDNF3150	1	90.00	36.00	24.00	⊕	⊕	600.00
	3R	90.00	36.00	24.00	⊕	⊕	600.00
	4	⊕	⊕	⊕	⊕	⊕	⊕
	4X SS	⊕	⊕	⊕	⊕	⊕	⊕
	4X Plastic	⊕	⊕	⊕	⊕	⊕	⊕
	12	90.00	36.00	24.00	⊕	⊕	600.00

Bypass Mechanisms for Non-Fusible Enclosed

Please consult factory for part numbers and dimensions.

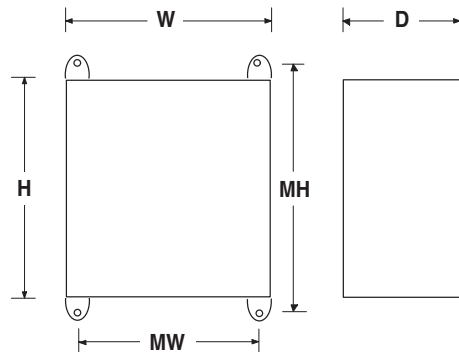

- 1 Please consult factory, enclosures are sized to suit specific customer needs.
- 2 Enclosure is free standing.
- 3 Some 4-pole switches require larger enclosures. Please consult factory.
- 4 Please consult factory for dimensions for bypass mechanisms for non-fusible disconnects.

NEMA Environmental Ratings for Enclosed Disconnect Switches

Introduction

An enclosure is a surrounding case constructed to provide a degree of protection to personnel against accidental contact with the enclosed equipment and to provide a degree of protection to the enclosed equipment against specified environmental conditions.

A brief description of the more common types of enclosures used by the electrical industry relating to their environmental capabilities follows. Refer to

NEMA Standards Publication for more information regarding applications, features and design tests.

Individual NEMA product Standards Publications or third party certification standards may contain additional requirements for product testing and performance.

Definitions pertaining to nonhazardous locations

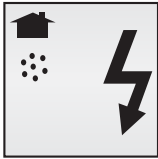

Type 1

Enclosures are intended for indoor use primarily to provide a degree of protection against limited amounts of falling dirt. (NEMA Standard 7-15-1991.)



Type 4X

Enclosures are intended for indoor or outdoor use primarily to provide a degree of protection against corrosion, windblown dust and rain, splashing water, hose-directed water and damage from external ice formation. (NEMA Standard 1-10-1979)

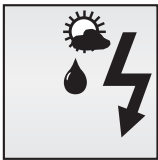

Type 3R

Enclosures are intended for outdoor use primarily to provide a degree of protection against rain, sleet and damage from external ice formation. (NEMA Standard 7-15-1991.)

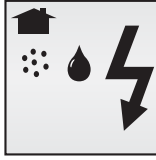

Type 12

Enclosures are intended for indoor use primarily to provide a degree of protection against circulating dust, falling dirt, and dripping noncorrosive liquids. (NEMA Standard 7-15-1991.)

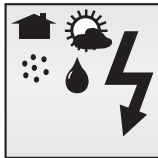

Type 4

Enclosures are intended for indoor or outdoor use primarily to provide a degree of protection against windblown dust and rain, splashing water, hose-directed water and damage from external ice formation. (NEMA Standard 1-10-1979.)



Type 13

Enclosures are intended for indoor use primarily to provide a degree of protection against dust, spraying of water, oil and noncorrosive coolant. (NEMA Standard 1-10-1979.)

Catalog Symbol	Page	Catalog Symbol	Page	Catalog Symbol	Page	Catalog Symbol	Page	Catalog Symbol	Page
BBDHK	57	BDS130S	3, 31	BK7C084	20	CDNF32A3	29, 31-33, 35, 59, 65	EFJ-----	71, 72
BD3RL	19, 57	BDS150	4, 7, 10, 32, 39, 42	BK7FCH4	20	CDNF32A3D	36, 38, 66	EFL-----	72
BDAUX1	15, 49, 53, 73, 81	BDS210	7, 10, 18, 39, 42, 56	BKD2R	20, 58	CDNF400U03	30, 45, 46, 60, 62, 64, 67	ENF-----	75-80
BDAUX12	73	BDS220	20, 58	BKDH3R	20, 58	CDNF45	31, 33, 34, 36, 61, 63, 83, 84	FD200J3-S	18
BDAUX157	5, 73	BDS250	14	BMKCS1	58	CDNF45A3	29, 31, 32, 59, 65	FD400J2	13
BDAUX2	15, 49, 53, 73, 81	BDS250S	3, 31	BMKCS2	20, 58	CDNF45A3D	36, 37, 66	FD400J3	2, 13, 21, 22, 23, 26
BDAUX3	15, 49, 53	BDS280	13, 14, 45, 48, 52	BMKCS3	20, 58	CDNF45D	38	FD400J3-FC	20
BDAUX4	15, 49, 53	BDS280A5	14, 45, 48, 53	BMKCS4	20, 58	CDNF60	31, 34, 36, 61, 63, 83, 84	FD400J3-S	18
BDAUX5	15, 49, 53	BDS290	7, 10, 39, 42	CDAUX01	33, 37, 81	CDNF60A3	29, 31, 32, 58, 59, 65	FD400J4	13
BDAUX6	15, 49, 53	BDS325	14, 18, 45, 48, 52, 56	CDAUX01K	5, 8, 11, 43, 46, 73, 81	CDNF60A3D	36, 66	FD600J2	13
BDBUS114	53	BDS325A5	14, 45, 48, 53	CDAUX10	5, 8, 11, 33, 37, 43, 46, 73, 81	CDNF63	31, 61, 63, 83, 84	FD600J3	2, 13, 21, 22, 23, 26
BDBUS115	53	BDS360	7, 10, 39, 42	CDAUX11	33, 37	CDNF63A3	29, 31, 32, 59, 65	FD600J3-FC	20
BDDHK	19, 57	BDS395	14, 45, 48, 52	CDAUX16011	40	CDNF63A3D	36, 66	FD600J4	13
BDFHNS12	19, 57	BDS430	7, 10, 39, 42	CDAUXB160	40	CDPB1	34, 38	FD800L2	13
BDFHNS4	19, 57	BDS465	14, 45, 48, 52	CDAUXCA01	40, 81	CDPB1EN1	34, 38	FD800L3	2, 13, 21, 22, 23, 26
BDFHS12	19, 57	BDS465A5	14, 45, 48, 53	CDAUXCA10	40, 81	CDPB2	34, 38	FD800L4	13
BDFHS17	19, 57	BDS535	14, 44, 48, 52	CDAUXM28	11, 43, 46	CDPB2EN1	34, 38	FD800L5	13
BDFHS22	19, 57	BDS725	7, 10, 32, 39, 42	CDY67121	5	CDPY1	34, 38	FDSBZK98	16
BDFLNF100-F	57	BDS729	7, 10, 32, 39, 42	CDY68005	41	CDPY1EN1	34, 38	FDSBZL79	16
BDFLNF100-S	56	BDS730	7, 10, 32, 39	CDY68140	38	CDPY2	34, 38	NDNA100	5, 8, 34
BDFLNF175-S	56	BDS74	7, 10, 32, 39, 42	CDD200P	11, 43	CDPY2EN1	34, 38	NDNA200	5, 8, 34
BDFLNF200A-F	57	BDTA1	8	CDE160P	40	CDS125PP	33	NNB-R	5
BDFLNF200A-S	56	BDTA4	14	CDE32PD	37	CDS160P	40		
BDFLNF30-F	57	BDTA6	14	CDE63PD	37	CDS32PD	37		
BDFLNF30-S	56	BDTL175/400	14, 20, 27, 49	CDEA-01AU	40	CDS32PP	33		
BDFLNF400-S	56	BDTL24	2, 8, 18-19, 21, 27, 56, 57	CDEA-10AU	40	CDS63PD	37		
BDFLNF600A-S	56	BDTL25	18, 56, 57	CDEA-2X01	40	CDS63PP	33		
BDFLNF60-F	57	BDTL26	2, 13, 14, 18, 20, 21, 27, 48, 56	CDEA-2X10	40	CDS67P	56		
BDFLNF60-S	56	BDTL27	2, 14, 20, 21, 27, 30, 49, 56, 60, 70	CDETL-ZT100	50	CDSA1	34		
BDH106	72, 82	BDTL28	30, 52, 53, 60, 70	CDETL-ZT80A/*	16, 50, 54	CDSA2	34		
BDH106SH	56	BDTL28/2	30, 53, 60, 70	CDETL-ZT80L/*	16, 50, 54	CDSA3	34		
BDH107	72, 82	BDTL30	30, 49, 60, 70	CDETL-ZW16	9, 11, 34, 40	CDSS200L3	11		
BDH107SH	56	BDTL32	49, 53	CDETL-ZW5	16, 46, 50, 54	CDSS200L4	11		
BDH110SH	18, 56	BDTP85	15	CDH3S	3	CDSS200S3	11		
BDH111SH	18, 55	BDTP88	15	CDH4	7	CDSS200S4	11		
BDH112	13, 45, 48	BDS12	53	CDH5S	72, 82	CDSSW5X8	32		
BDH113	13, 45, 48	BDS4	49	CDH6S	72, 82	CDT-E	34		
BDH114	13, 45, 48, 52, 72, 82	BDS6A	49	CDH9S	36	CDTL200	2, 10, 11, 20, 21, 27, 30, 42, 43, 58, 60		
BDH114SH	18, 56	BDS8A	49	CDHTB20	42	CDTL200/3P	11, 20, 43, 58, 70		
BDH115	13, 45, 48, 52, 72, 82	BDS8A	49	CDHTY20	42	CDTL206	11, 20, 27, 43, 58, 70		
BDH115SH	18, 56	BDZD28	5	CDHXB12	13, 45, 48, 52, 72, 82	CDTL400	30, 45, 46, 60		
BDH116	13, 45, 48, 52, 72, 82	BDZD48	5	CDHXB22	13, 45, 48, 52, 72, 82	CDTL400/3P	46, 70		
BDH117	13, 45, 48, 52, 72, 82	BDZW1	35, 41	CDHXB65L6	4, 32, 72, 82	CDTL-ST	34		
BDH120	82	BDZW10	9, 44	CDHXB86	7, 10, 39, 42, 72, 82	CDTL-ZX58	34		
BDH121	82	BDZW12	47, 51, 55	CDHXY12	13, 45, 48, 52, 72, 82	CDS100T1	34, 38		
BDH58	4, 7, 10, 32, 39, 72	BDZW13	47, 51, 55	CDHXY22	13, 45, 48, 52, 72, 82	CDS100T3	34, 38		
BDH58SH	18	BDZW14	47, 51	CDHXY65	72, 82	CDS250G1L/3	43		
BDH58T	4	BDZW15	47, 51, 55	CDHXY65L6	4, 32	CDS250G1L/4	43		
BDH59	4, 7, 10, 32, 39, 42, 72	BDZW1X	41	CDL125PP	33	CDS250G1S/3	43		
BDH59SH	18	BDZW2	9, 12, 28, 41, 44	CDL63PP	33	CDS250G1S/4	43		
BDH59T	4	BDZW3	47, 51	CDL65PD	37	CDZK19	9, 12, 41, 44, 47		
BDH60	7, 10, 39, 42, 72, 82	BDZW5	6	CDMB160	40	CDZW10	41		
BDH61	7, 10, 39, 42, 72, 82	BDZW9	17, 28, 47, 51, 55	CDMC2	41	CDZW17	35		
BDH8	13, 48, 52, 72, 82	BDZW95	9, 12, 16, 43, 46, 50, 54	CDN160P	40	CDZW25	44		
BDHFC12	20, 58	BDZX108	16, 50	CDN32PD	37	CDZW26	44		
BDHFC4	20, 58	BDZX167	9, 12, 40, 43	CDN63PD	37	CDZW8	35		
BDNF1200	30, 52-55, 60, 62, 64, 68, 83, 84	BDZX196	15	CDNF100	31, 58, 61, 63, 83, 84	CFC60J	8		
BDNF12002	52	BDZX197	15	CDNF100A3	29, 31-33, 35-37, 58, 59, 65, 66	CFCVR100	8		
BDNF12004	52	BDZX204	15	CDNF100A3D	36, 37, 66	CFCVR200	11		
BDNF1600	30, 52, 53, 60, 62, 64, 69, 83, 84	BDZX216	15	CDNF100S	36	CFD100J3	2, 7, 21, 22, 23, 25		
BDNF16002	52, 53	BDZX271	15	CDNF16	29, 31-36, 59, 61, 63, 83, 84	CFD100J3F	19		
BDNF16004	52	BDZX272	15	CDNF160	29, 39, 41, 59, 61, 63, 83, 84	CFD100J3S	18		
BDNF2000	30, 52, 53, 60, 62, 64, 69, 83, 84	BDZX273	15	CDNF160-2	39	CFD200J03	2, 10, 11, 20, 21, 22, 23, 25		
BDNF20002	52	BDZX71	49, 54	CDNF160D	39	CFD200J04	10, 11		
BDNF20004	52	BDZX73	49	CDNF16A3	29, 31, 32, 59, 65	CFD30CC3	2, 21, 22, 23		
BDNF3150	30, 52-55, 60, 62, 64, 68, 83, 84	BDZX74	18, 56	CDNF16A3D	36, 37, 66	CFD30CC3S	18		
BDNF31502	52	BDZX85	49	CDNF16D	38	CFD30J3F	19		
BDNF31504	52	BDZX90	54	CDNF200U03	30, 42, 43, 58, 60, 62, 64, 67	CFD30J3S	18		
BDNF600A	30, 48-51, 60, 62, 64, 67	BDZX95	12, 40, 43	CDNF200U04	42, 43	CFD60J3	2, 7, 20, 21, 22, 23, 24		
BDNF600A2	48	BDZXB	6	CDNF25	31, 61, 63, 83	CFD60J3F	19		
BDNF600A4	48	BFCL108	20	CDNF25A3	29, 31, 32, 59, 65	CFD60J3S	18		
BDNF800A	30, 48-51, 60, 62, 64, 68	BFCL36	20, 58	CDNF25A3D	36, 66	CFD60J4	7		
BDNF800A2	48	BFCL48	20, 58	CDNF25DA3D	38	CFDZX171	5		
BDNF800A4	48	BFCL60	20, 58	CDNF30	31-34, 36, 58, 61, 63, 83, 84	CFTS100	8		
BDS130	39, 42	BFCL72	20, 58	CDNF30A3	29, 31, 32, 58, 59, 65	CFZ1	8		
		BFCL84	20, 58	CDNF30A3D	36, 37, 66	CFZ2	8		
		BFCL96	20	CDNF30D	38	CPBR200	11		
		BK7C048	20	CDNF32	31, 61, 63, 83, 84	CXBY68100	41		
		BK7C060	20			EFC-----	71, 72		
		BK7C072	20						

Cooper Bussmann: Leading Industry in Downtime Reduction, Workplace Safety & Code Compliance Solutions

Customer Satisfaction Team

Available to answer questions regarding Cooper Bussmann products & services Monday-Friday, 8:00 a.m. – 4:30 p.m. for all US time zones. Contact:

- Phone: 636-527-3877
- Toll-free fax: 800-544-2570
- E-mail: busscustsat@cooperindustries.com

Emergency and After-Hours Orders

Next flight out or will call shipment for time-critical needs. Customers pay only standard product price, rush freight charges, & modest emergency service fee. Place these orders through the Customer Satisfaction Team during regular business hours. For after-hours, contact:

- Phone: 314-995-1342

C3 – the Enhanced, Online Cooper Customer Center

Provides real time product availability, net pricing, order status & shipment tracking across six Cooper divisions: B-line, Bussmann, Crouse-Hinds, Lighting, Power Systems & Wiring Devices. Available at:

- www.cooperc3.com
- 877-995-5955 for log-in assistance

Application Engineering

Technical assistance is available to all customers. Staffed by degreed engineers, this application support is available Monday-Friday, 8:00 a.m. – 5:00 p.m. Central Time. Contact:

- Phone: 636-527-1270
- Fax: 636-527-1607
- E-mail: fusetech@cooperindustries.com
- Live Chat: www.cooperbussmann.com

Online Resources

Visit www.cooperbussmann.com for the following resources:

- Product search & cross-reference
- Product & technical materials
- Solutions centers for information on topical issues including arc-flash, selective coordination & short-circuit current rating
- Technical tools, like our arc-flash calculator
- Where to purchase Cooper Bussmann product

Services

Cooper Bussmann Services team provides engineering expertise in electrical system reviews, electrical safety training & component testing for Agency compliance. Contact:

- Phone: 636-207-3294
- E-mail: services@cooperindustries.com