

Fixed Voltage Multiport Series - MS-013



Agency Approvals

Agency	Agency File Number
	E133083

Pinout Designation

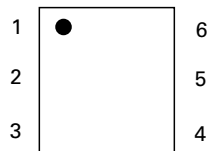

Schematic Symbol

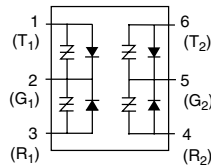

Description

Fixed Voltage Multiport Series MS-013 are SIDACtor® components designed to protect sensitive SLIC (Subscriber Line Interface Circuit) devices from damaging overvoltage transients.

The series provides a high surge current rated dual port protection solution incorporating a fixed voltage switching threshold for negatives surges. All positive surges are routed through an internal diode to a ground reference.

Features and Benefits

- Low voltage overshoot positive voltage surges
- Low on-state voltage
- Does not degrade surge capability after multiple surge events within limit.
- Fails short circuit when surged in excess of ratings
- Two-port protection
- Integrated diodes for
- RoHS compliant and Halogen-free
- Replaces four discrete components
- Pb-free E3 means 2nd level interconnect is Pb-free and the terminal finish material is tin(Sn) (IPC/JEDEC J-STD-609A.01)

Applicable Global Standards

- TIA-968-A
- TIA-968-B
- ITU K.20/21 Enhanced Level*
- ITU K.20/21 Basic Level
- GR 1089 Intra-building
- IEC 61000-4-5
- YD/T 1082
- YD/T 993
- YD/T 950
- GR 1089 Inter-building*

*A-rated parts require series resistance

Electrical Characteristics

Part Number	Marking	V_{DRM}	V_S	I_H	I_S	I_T	V_T	V_F	Capacitance
		@ $I_{DRM}=5\mu A$	@ $100V/\mu s$	mA min	mA max	A max	@ $I_T=2.2$ Amps	V max	
P0641UALxx	P0641UA	58	77	120	800	2.2	4	5	See Capacitance Values Table
P0721UALxx	P0721UA	65	88	120	800	2.2	4	5	
P0901UALxx	P0901UA	75	98	120	800	2.2	4	5	
P1101UALxx	P1101UA	95	130	120	800	2.2	4	5	
P1301UALxx	P1301UA	120	160	120	800	2.2	4	5	
P1701UALxx	P1701UA	160	200	120	800	2.2	4	5	
P0641UCLxx	P0641UC	58	77	120	800	2.2	4	5	
P0721UCLxx	P0721UC	65	88	120	800	2.2	4	5	
P0901UCLxx	P0901UC	75	98	120	800	2.2	4	5	
P1101UCLxx	P1101UC	95	130	120	800	2.2	4	5	
P1301UCLxx	P1301UC	120	160	120	800	2.2	4	5	
P1701UCLxx	P1701UC	160	200	120	800	2.2	4	5	

Notes:

- Absolute maximum ratings measured at $T_A = 25^\circ C$ (unless otherwise noted).
- Components are not appropriate for positive ringing systems
- All electrical characteristics shown are defined from Tip (pins 1 & 6) to Ground (pins 2 & 5), and Ring (pins 3 & 4) to Ground (pins 2 & 5)
- **XX** = Part Number Suffix: **'TP'** (Tube Pack) or **'RP'** (Reel Pack).

Capacitance Values

Part Number	pF Pin 1-2 / 3-2 (4-5/6-5) Tip-Ground, Ring-Ground		pF Pin 1-3 (4-6) Tip-Ring	
	MIN	MAX	MIN	MAX
	P0641UALxx	50	205	30
P0721UALxx	45	195	20	125
P0901UALxx	40	180	20	115
P1101UALxx	40	160	15	105
P1301UALxx	35	160	15	100
P1701UALxx	30	125	15	80
P0641UCLxx	65	205	40	130
P0721UCLxx	60	195	20	125
P0901UCLxx	60	180	20	115
P1101UCLxx	50	160	15	105
P1301UCLxx	35	160	15	100
P1701UCLxx	40	125	15	80

Note: Off-state capacitance (C_{O}) is measured at 1 MHz with a -2V bias.

Surge Ratings

Series	I_{PP}									I_{TSM} 50/60 Hz	di/dt
	0.2/310 ¹ 0.5/700 ²	2/10 ¹ 2/10 ²	8/20 ¹ 1.2/50 ²	10/160 ¹ 10/160 ²	10/560 ¹ 10/560 ²	5/320 ¹ 9/720 ²	10/360 ¹ 10/360 ²	10/1000 ¹ 10/1000 ²	5/310 ¹ 10/700 ²		
	A min	A min	A min	A min	A min	A min	A min	A min	A min		
A	20	150	150	90	50	75	75	45	75	20	500
C	50	500	400	200	150	200	175	100	200	30	500

Notes:

1 Current waveform in μ s

2 Voltage waveform in μ s

- Peak pulse current rating (I_{pp}) is repetitive and guaranteed for the life of the product.

- I_{pp} ratings applicable over temperature range of -40°C to +85°C

- The component must initially be in thermal equilibrium with -40°C $\leq T_J \leq$ +150°C

Thermal Considerations

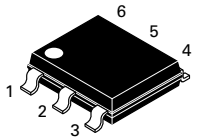
Package	Symbol	Parameter	Value	Unit
Modified MS-013 	T_J	Operating Junction Temperature Range	-40 to +125	°C
	T_S	Storage Temperature Range	-65 to +150	°C
	$R_{\theta JA}$	Thermal Resistance: Junction to Ambient	60	°C/W

Additional Information



Datasheet



Resources



Samples

V-I Characteristics

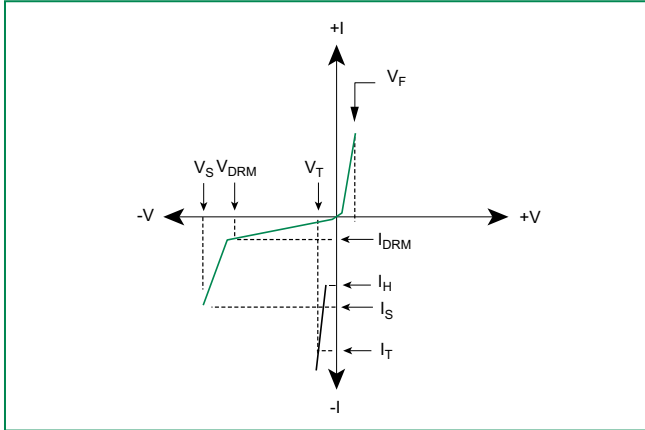

$t_r \times t_d$ Pulse Waveform

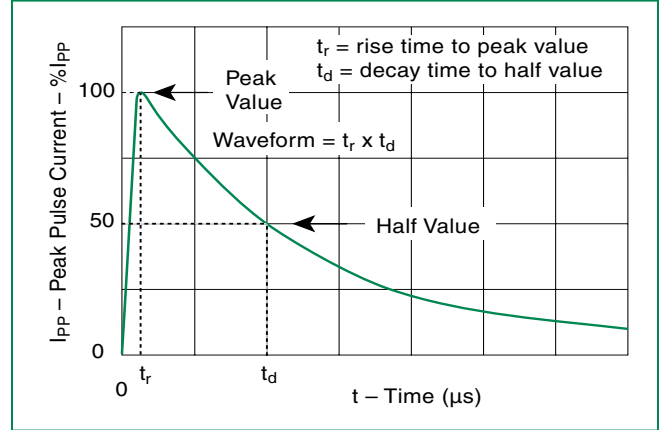

Normalized V_S Change vs. Junction Temperature

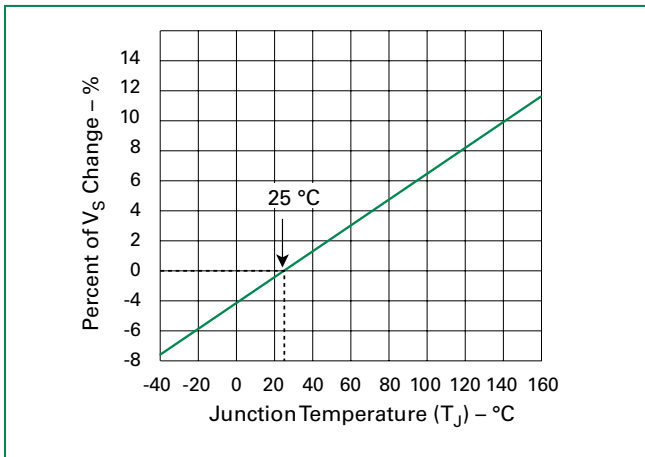

Normalized DC Holding Current vs. Case Temperature

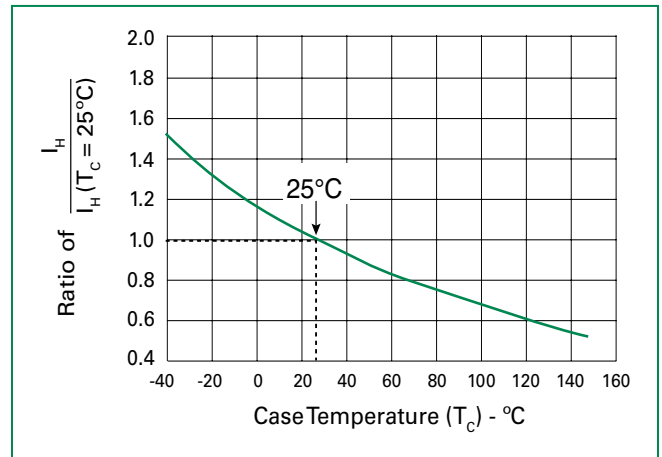

Soldering Parameters

Reflow Condition		Pb-Free assembly (see Fig. 1)
Pre Heat	-Temperature Min ($T_{s(min)}$)	+150°C
	-Temperature Max ($T_{s(max)}$)	+200°C
	-Time (Min to Max) (t_s)	60-180 secs.
Average ramp up rate (Liquidus Temp (T_L) to peak)		3°C/sec. Max.
$T_{s(max)}$ to T_L - Ramp-up Rate		3°C/sec. Max.
Reflow	-Temperature (T_L) (Liquidus)	+217°C
	-Temperature (t_L)	60-150 secs.
Peak Temp (T_p)		+260(+0/-5)°C
Time within 5°C of actual Peak Temp (t_p)		30 secs. Max.
Ramp-down Rate		6°C/sec. Max.
Time 25°C to Peak Temp (T_p)		8 min. Max.
Do not exceed		+260°C

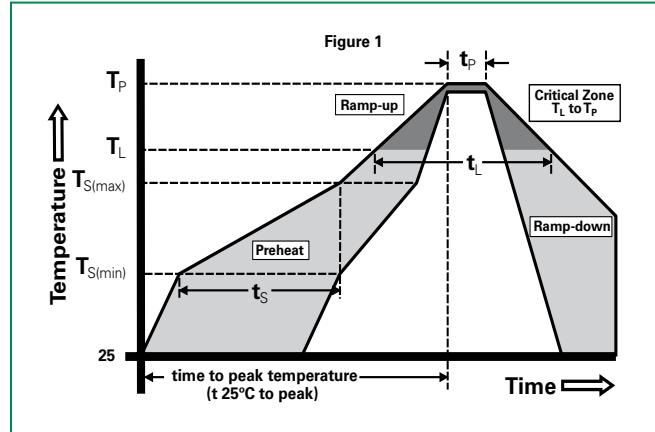

Environmental Specifications

High Temp Voltage Blocking	80% Rated V_{DRM} (V_{DC}) +125°C or +150°C, 504 or 1008 hrs. MIL-STD-750 (Method 1040) JEDEC, JESD22-A-101
Temp Cycling	-65°C to +150°C, 15 min. dwell, 10 up to 100 cycles. MIL-STD-750 (Method 1051) EIA/JEDEC, JESD22-A104
Biased Temp & Humidity	52 V_{DC} (+85°C) 85%RH, 504 up to 1008 hrs. EIA/JEDEC, JESD22-A-101
High Temp Storage	+150°C 1008 hrs. MIL-STD-750 (Method 1031) JEDEC, JESD22-A-101
Low Temp Storage	-65°C, 1008 hrs.
Thermal Shock	0°C to +100°C, 5 min. dwell, 10 sec. transfer, 10 cycles. MIL-STD-750 (Method 1056) JEDEC, JESD22-A-106
Autoclave (Pressure Cooker Test)	+121°C, 100%RH, 2atm, 24 up to 168 hrs. EIA/JEDEC, JESD22-A-102
Resistance to Solder Heat	+260°C, 30 secs. MIL-STD-750 (Method 2031)
Moisture Sensitivity Level	85%RH, +85°C, 168 hrs., 3 reflow cycles (+260°C Peak). JEDEC-J-STD-020, Level 1

Physical Specifications

Lead Material	Copper Alloy
Terminal Finish	100% Matte-Tin Plated
Body Material	UL Recognized epoxy meeting flammability classification V-0

Part Numbering

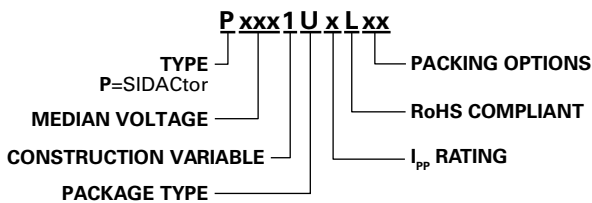

Part Marking

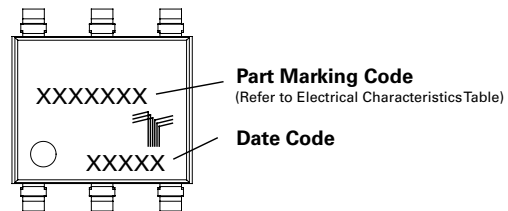

Dimensions – MS-013

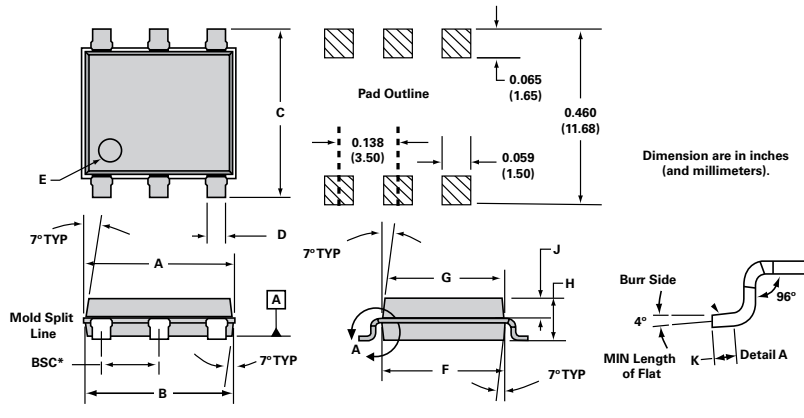

Dimensions	Inches		Millimeters	
	Min	Max	Min	Max
A	0.360	0.364	9.14	9.25
B	0.352	0.356	8.94	9.04
C	0.400	0.412	10.16	10.46
D	0.043	0.045	1.09	1.13
E	0.047	0.055	1.19	1.40
F	0.293	0.297	7.44	7.54
G	0.289	0.293	7.34	7.44
H	0.089	0.093	2.26	2.36
J	0.041	0.049	1.04	1.24
K	0.020		0.51	
BSC*	0.133	0.143	3.38	3.63

* BSC = Basic Spacing between Centers

Packing Options

Package Type	Description	Quantity	Added Suffix	Industry Standard
U	Modified MS-013 6-pin Tape and Reel Pack	1500	RP	EIA-481-D
	Modified MS-013 6-pin Tube Pack	500 (50 per tube)	TP	N/A

Tape and Reel Specification – MS-013

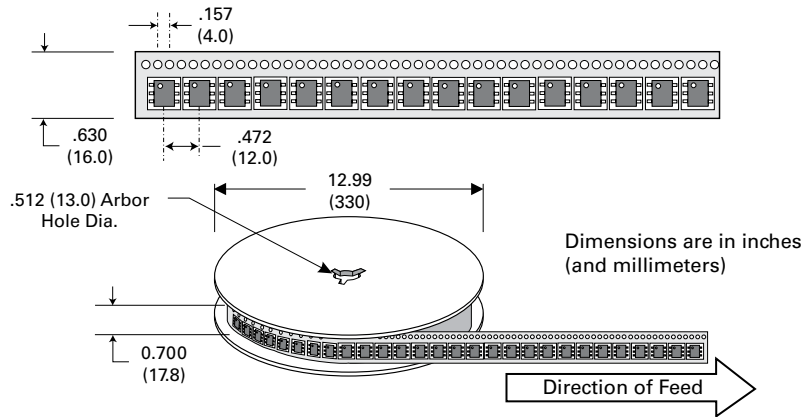

Tube Pack Dimensions – MS-013

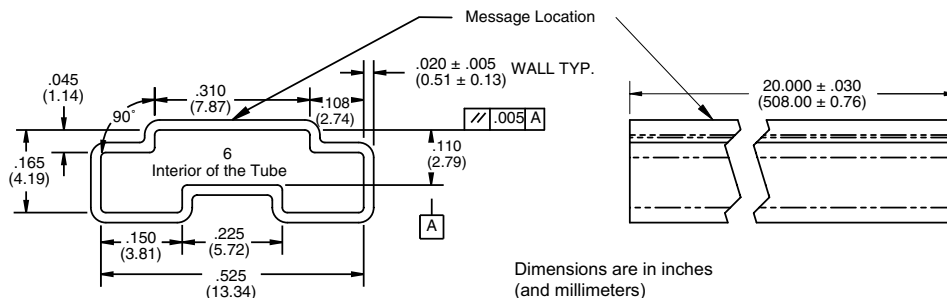

Disclaimer Notice - Information furnished is believed to be accurate and reliable. However, users should independently evaluate the suitability of and test each product selected for their own applications. Littelfuse products are not designed for, and may not be used in, all applications. Read complete Disclaimer Notice at www.littelfuse.com/disclaimer-electronics.