



Figure 1. Physical Photo of AHVAC20KVR5MABT

FEATURES

- High precision
- High efficiency
- High output voltage stability
- Linear modulation of output voltage
- Low cost
- Overcurrent protection
- Short circuit protection
- Digital display for output voltage

APPLICATIONS

AHVAC20KVR5MABT, is designed for achieving AC-DC conversion from AC voltage to high DC voltage. High voltage power supply is widely used in industrial measurement and control, energy spectrum analysis, and medical equipment such as: X-ray machine, vacuum/plasma processing, semiconductor fabrication equipment, analytical instrumentation, medical diagnostic and therapeutic systems, test equipment, and research and academic applications, etc.

DESCRIPTION

Connect AC 90~230V input, and then power on. When the potentiometer is in "0", open the high voltage switch, and then adjust the potentiometer clockwise. Observe the digital display readings, and high voltage power supply output

voltage = the reading \times 100V. When the required voltage is achieved, then rotate the potentiometer lock clockwise to lock the potentiometer. This prevents the output voltage changes caused by rotating the potentiometer by accident. High voltage connection wire is used for high voltage output.

SAFETY PRECAUTIONS

High voltage power supply must be connected to ground reliably.

Do not touch the high voltage wire, unless the high voltage power supply is powered off, and the load and internal capacitors are fully discharged.

When the high voltage power supply is powered off, wait for another 5 minutes for fully discharging all the capacitors inside the power supply.

Do not operate the power supply in humid environment, and do not connect the operator to ground.

The internal protection circuit is provided in the high voltage power supply, but the high voltage short circuit shall be avoided.

Make sure the circuit is insulated perfectly, especially between the high voltage output and the surroundings so as to avoid electronic shock.



SPECIFICATIONS

Table 1. Characteristics.

T_A = 25°C, unless otherwise noted

Parameter	Symbol	Condition	Min.	Typ.	Max.	Unit/Note
AC Input Voltage	VPS		90	110	230	V _{AC}
Quiescent Input Current	I _{INQQ}	I _{OUT} = 0mA	120	130	140	mA
Full Load Input Current	I _{INFLD}	I _{OUT} = 0.5mA	150	200	250	mA
Input Voltage Regulation Ratio	ΔV _{OUT} /ΔVPS	VPS = 90V ~ 230V		0.05		%
Output Voltage	V _{OUT}	I _{OUT} = 0 ~ 0.5mA	0		20000	V
Maximum Output Current	I _{OUTMAX}	VPS = 90V ~ 230V			0.5	mA
Load				40		MΩ
Potentiometer Adjustment			10k potentiometer			
Output Modulation Linearity				<0.1		%
Load Regulation Rate		I _{OUT} = 0 ~ 0.5mA		≤0.05		%
Instantaneous Short Circuit Current	I _{SC}			<0.1		mA
Full Load Efficiency	η			≥70		%
Temperature Coefficient	TCV _O	-20 ~ 50°C		<0.01		%/°C
Time Drift	Short Time Drift			<0.05		%/ min
	Long Time Drift			<0.05		%/h
Output Voltage Temperature Stability		-20 ~ 50°C		<±0.05		%
Operating Temperature Range	T _{opr}		-20		55	°C
Storage Temperature Range	T _{stg}		-20		80	°C
External Dimensions			210×120×50			mm
Weight				1192		g
				2.63		lbs
				42.05		Oz



PANEL INSTRUCTIONS

Left Panel

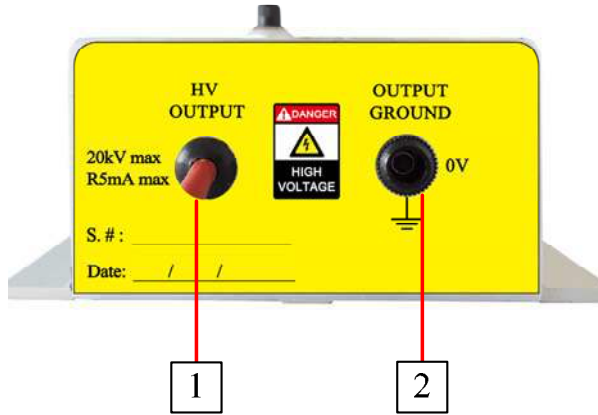

Figure 2. Left Panel

- 1. HV output: 1m long connection wire outputs 20kV 0.5MA.
- 2. Output ground: high voltage power supply output ground terminal.

Front Panel

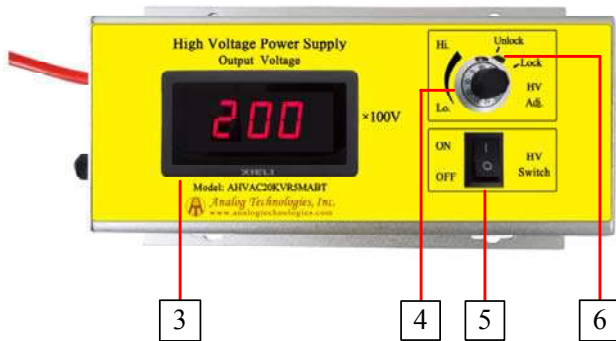

Figure 3. Front Panel

- 3. Output display: Digital display for output voltage. The actual output voltage = display reading × 100V.
- 4. HV adjustment: 10-turn potentiometer for adjusting output voltage. Rotate it clockwise to increase the output voltage, and the potentiometer resistance = the corresponding scale × 10Ω. For example, as Figure 4 shows, when the scale is 10, and the frame above the scale shows 1 (1kΩ), then the

resistance = 10×10Ω+1kΩ=1.1kΩ, and the like.



Figure 4. Scale and Resistance Calculation

- 5. High voltage ON/OFF switch
- 6. Potentiometer lock: when turn the lock clockwise, then the potentiometer is locked, so that the POT will not be rotated for any voltage change.

Right Panel

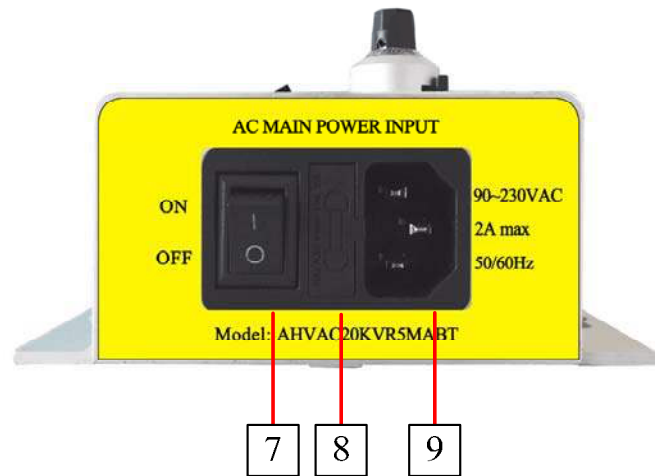

Figure 5. Right Panel

- 7. Main power ON/OFF switch
- 8. Fuse: 250V/2A
- 9. Input connector: AC input 90 ~ 230V 50/60Hz connector.



TESTING DATA

High voltage power supply testing data (Test condition: the load is 40 MΩ)

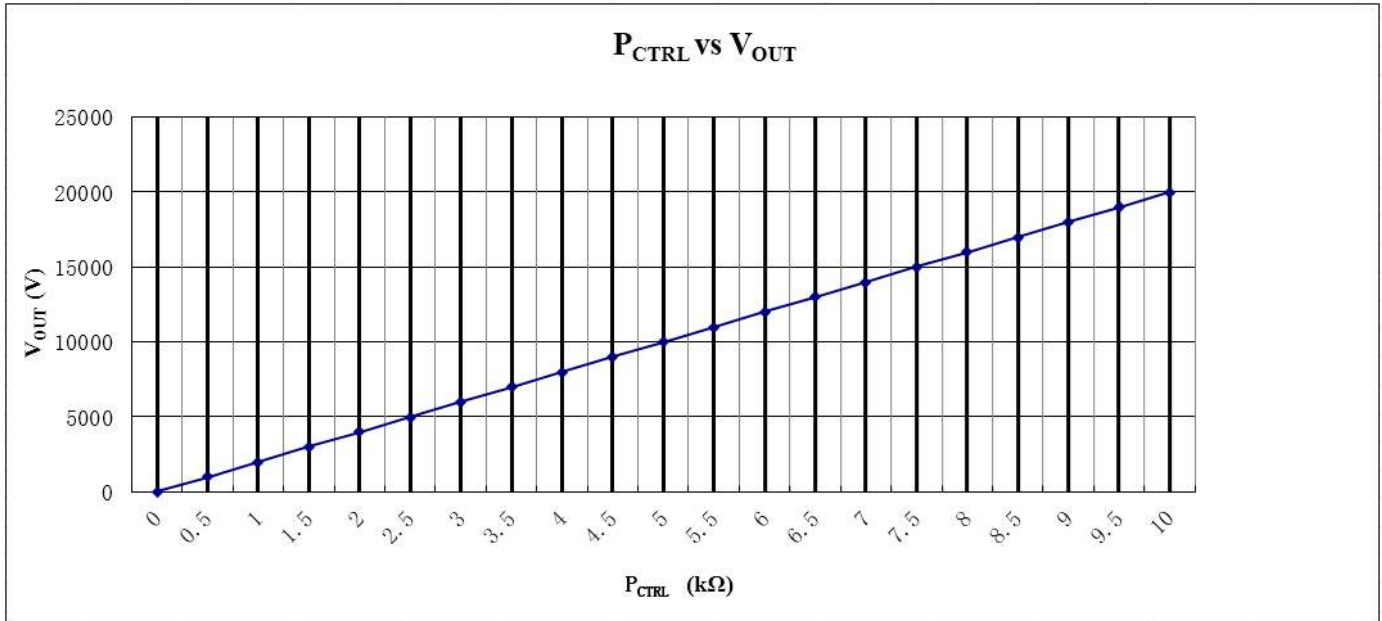

Figure 6. P_CTRL vs. V_OUT

NAMING INSTRUCTIONS

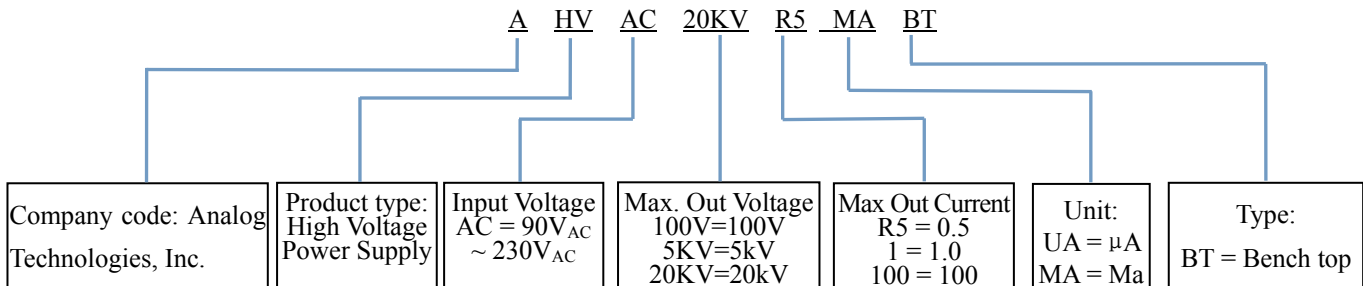

Figure 7. Naming Rules of AHVAC20KVR5MABT



DIMENSIONS

I. Dimension of the leads.



Figure 8. Leads of AHVAC20KVR5MABT

Leads	Diameter (mm)	Length (m)
Thick brown lead	4.5	1.0
Power cord	6.5	1.8

II. Dimension of AHVAC20KVR5MABT.

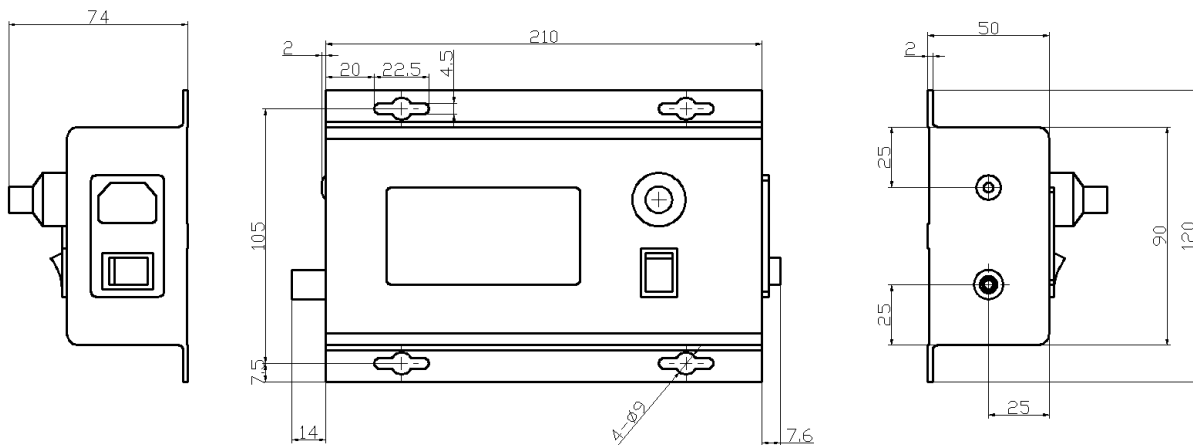

Figure 9. Dimensions for AHVAC20KVR5MABT



PRICES

Quantity (pcs)	1~9	10~49	50~99	≥100
AHVAC20KVR5MABT	\$469	\$459	\$449	\$439

NOTICE

- ATI warrants performance of its products for one year to the specifications applicable at the time of sale, except for those being damaged by excessive abuse. Products found not meeting the specifications within one year from the date of sale can be exchanged free of charge.
- ATI reserves the right to make changes to its products or to discontinue any product or service without notice, and advise customers to obtain the latest version of relevant information to verify, before placing orders, that information being relied on is current and complete.
- All products are sold subject to the terms and conditions of sale supplied at the time of order acknowledgment, including those pertaining to warranty, patent infringement, and limitation of liability. Testing and other quality control techniques are utilized to the extent ATI deems necessary to support this warranty. Specific testing of all parameters of each device is not necessarily performed, except those mandated by government requirements.
- Customers are responsible for their applications using ATI components. In order to minimize risks associated with the customers' applications, adequate design and operating safeguards must be provided by the customers to minimize inherent or procedural hazards. ATI assumes no liability for applications assistance or customer product design.
- ATI does not warrant or represent that any license, either express or implied, is granted under any patent right, copyright, mask work right, or other intellectual property right of ATI covering or relating to any combination, machine, or process in which such products or services might be or are used. ATI's publication of information regarding any third party's products or services does not constitute ATI's approval, warranty or endorsement thereof.
- IP (Intellectual Property) Ownership: ATI retains the ownership of full rights for special technologies and/or techniques embedded in its products, the designs for mechanics, optics, plus all modifications, improvements, and inventions made by ATI for its products and/or projects.