

LG R971

CHIPLED® 0805



Applications

- Electronic Equipment
- Gaming, Amusement, Gambling
- White Goods

Features:

- Package: SMT package 0805, colorless diffused resin
- Chip technology: GaAsP
- Typ. Radiation: 150°
- Color: $\lambda_{\text{dom}} = 570 \text{ nm}$ (● green)
- Optical efficacy: 2.5 lm/W
- Corrosion Robustness Class: 3B
- ESD: 2 kV acc. to ANSI/ESDA/JEDEC JS-001 (HBM)

Ordering Information

Type	Luminous Intensity ¹⁾ $I_F = 20 \text{ mA}$ I_v	Ordering Code
LG R971-KN-1	7.1 ... 45.0 mcd	Q62702P5179

Maximum Ratings

Parameter	Symbol		Values
Operating Temperature	T_{op}	min. max.	-30 °C 85 °C
Storage Temperature	T_{stg}	min. max.	-40 °C 85 °C
Junction Temperature	T_j	max.	95 °C
Forward current $T_A = 25\text{ °C}$	I_F	max.	25 mA
Surge Current $t \leq 10\text{ }\mu\text{s}$; $D = 0.005$; $T_A = 25\text{ °C}$	I_{FS}	max.	100 mA
Reverse voltage ²⁾ $T_A = 25\text{ °C}$	V_R	max.	12 V
ESD withstand voltage acc. to ANSI/ESDA/JEDEC JS-001 (HBM)	V_{ESD}		2 kV

Characteristics

$I_F = 20 \text{ mA}$; $T_A = 25 \text{ °C}$

Parameter	Symbol		Values
Peak Wavelength	λ_{peak}	typ.	572 nm
Dominant Wavelength ³⁾	λ_{dom}	typ.	570 nm
Spectral Bandwidth at 50% $I_{\text{rel,max}}$	$\Delta\lambda$	typ.	30 nm
Viewing angle at 50% I_V	2ϕ	typ.	160 °
Forward Voltage ⁴⁾ $I_F = 20 \text{ mA}$	V_F	typ. max.	2.20 V 2.50 V
Reverse current ²⁾ $V_R = 12 \text{ V}$	I_R	typ. max.	0.02 μA 100 μA
Temperature Coefficient of Peak Wavelength	$TC_{\lambda_{\text{peak}}}$	typ.	0.1 nm / K
Temperature Coefficient of Dominant Wavelength	$TC_{\lambda_{\text{dom}}}$	typ.	0.06 nm / K
Temperature Coefficient of Forward Voltage	TC_{V_F}	typ.	-1.4 mV / K
Real thermal resistance junction/ambient ⁵⁾⁶⁾	$R_{\text{thJA real}}$	max.	800 K / W
Real thermal resistance junction/solderpoint ⁵⁾	$R_{\text{thJS real}}$	max.	450 K / W

Brightness Groups

Group	Luminous Intensity ¹⁾ $I_F = 20 \text{ mA}$ min. I_v	Luminous Intensity. ¹⁾ $I_F = 20 \text{ mA}$ max. I_v	Luminous Flux ⁷⁾ $I_F = 20 \text{ mA}$ typ. Φ_v
K	7.1 mcd	11.2 mcd	25.1 mlm
L	11.2 mcd	18.0 mcd	40.0 mlm
M	18.0 mcd	28.0 mcd	63.0 mlm
N	28.0 mcd	45.0 mcd	100.0 mlm

Group Name on Label

Example: K

Brightness

K

Relative Spectral Emission ⁷⁾

$I_{rel} = f(\lambda); I_F = 20 \text{ mA}; T_A = 25 \text{ }^\circ\text{C}$

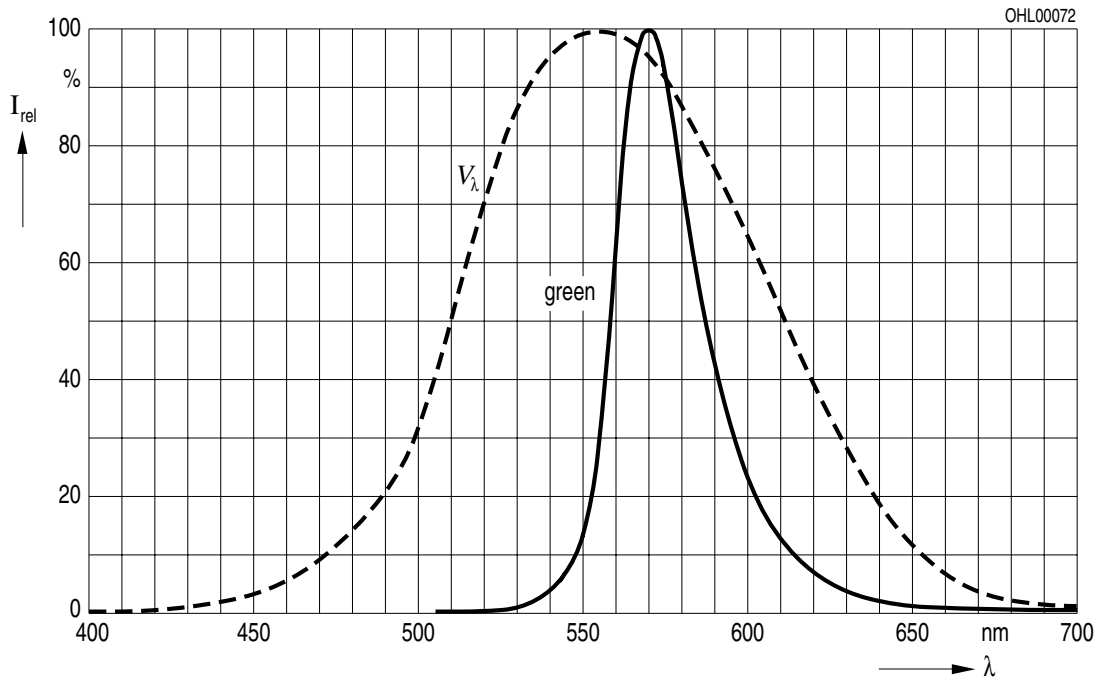

Radiation Characteristics ⁷⁾

$I_{rel} = f(\phi); T_A = 25 \text{ }^\circ\text{C}$

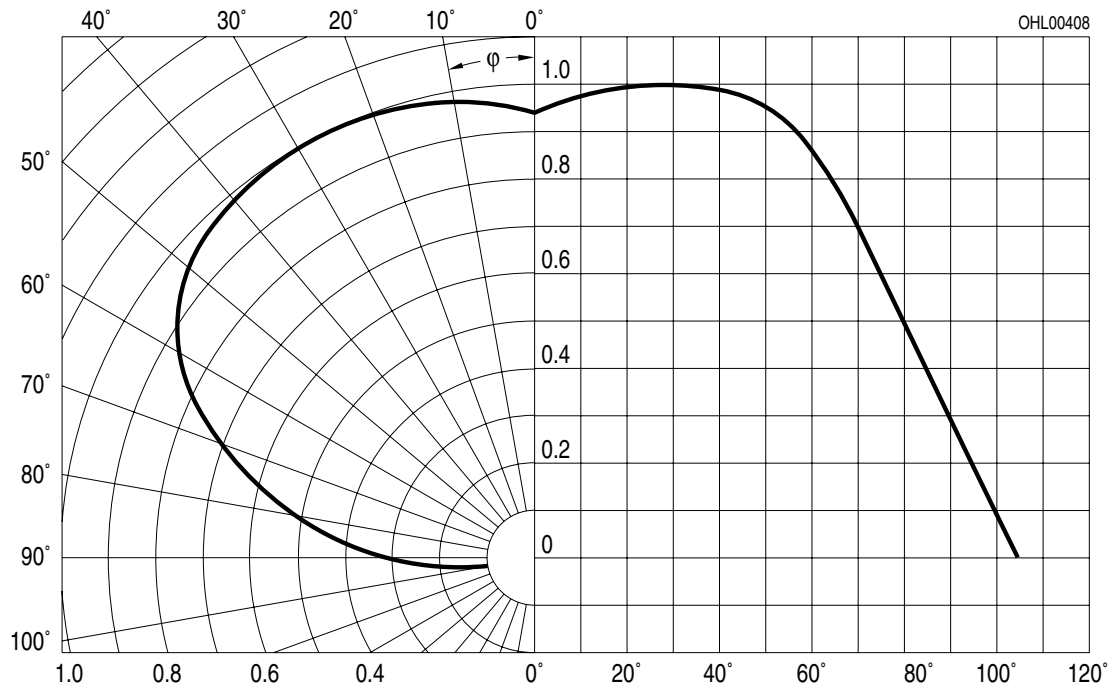

Forward current 7), 8)

$I_F = f(V_F); T_A = 25\text{ °C}$

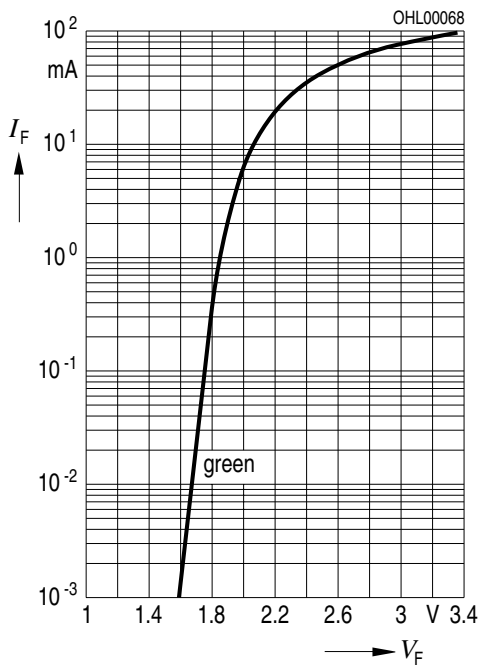

Relative Luminous Intensity 7), 8)

$I_V/I_V(20\text{ mA}) = f(I_F); T_A = 25\text{ °C}$

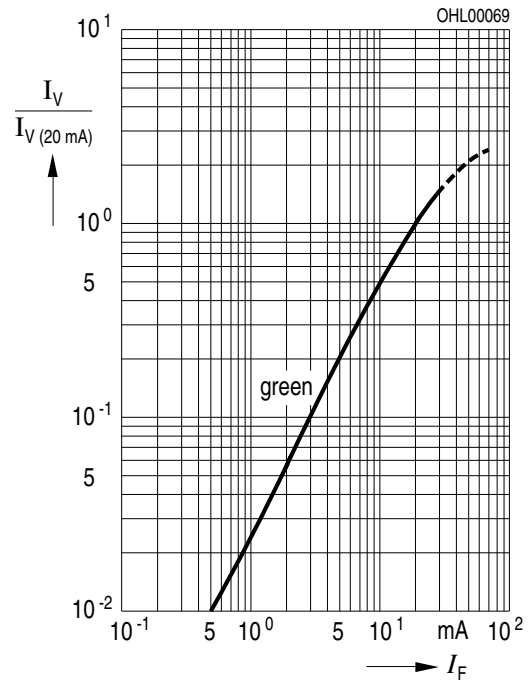

Relative Luminous Intensity 7)

$I_V/I_V(25\text{ °C}) = f(T_j); I_F = 20\text{ mA}$

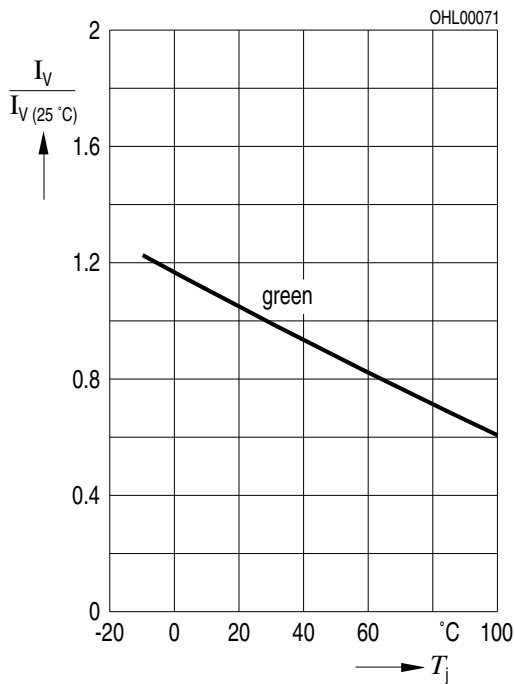

Max. Permissible Forward Current

$$I_F = f(T)$$

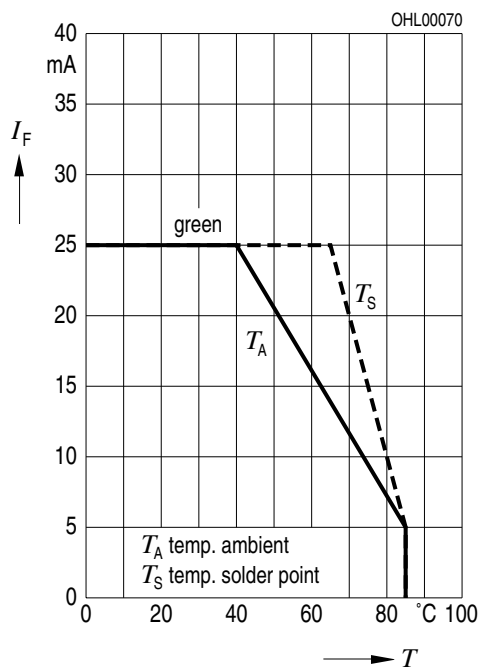

Dimensional Drawing ⁹⁾

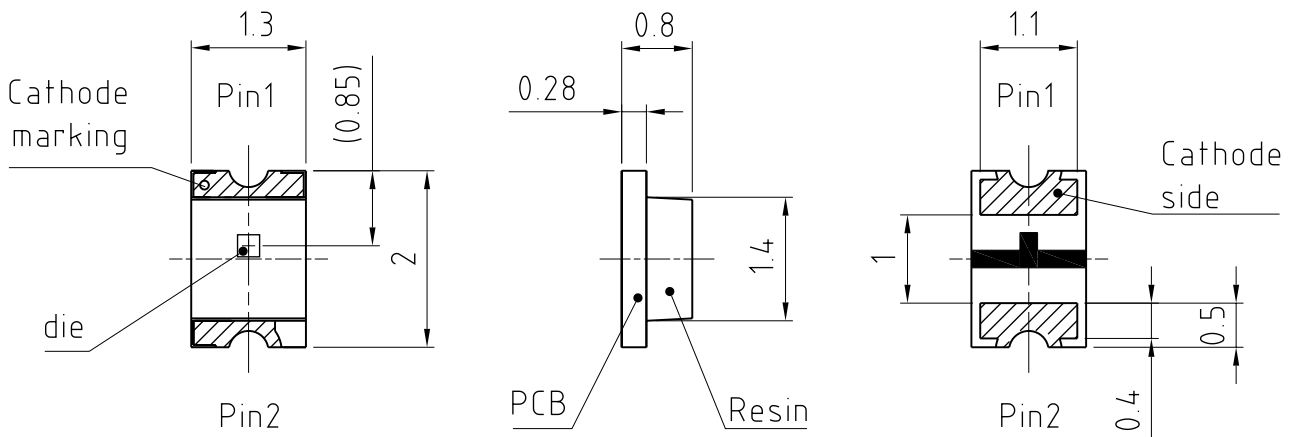

general tolerance ± 0.1
 lead finish Au 

C63062-A3881-A1..-02

Further Information:

Approximate Weight: 3.0 mg

Corrosion test: Class: 3B
 Test condition: 40°C / 90 % RH / 15 ppm H₂S / 14 days (stricter than IEC 60068-2-43)

Electrical Internal Circuit

Polarity

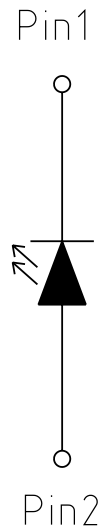

Recommended Solder Pad ⁹⁾

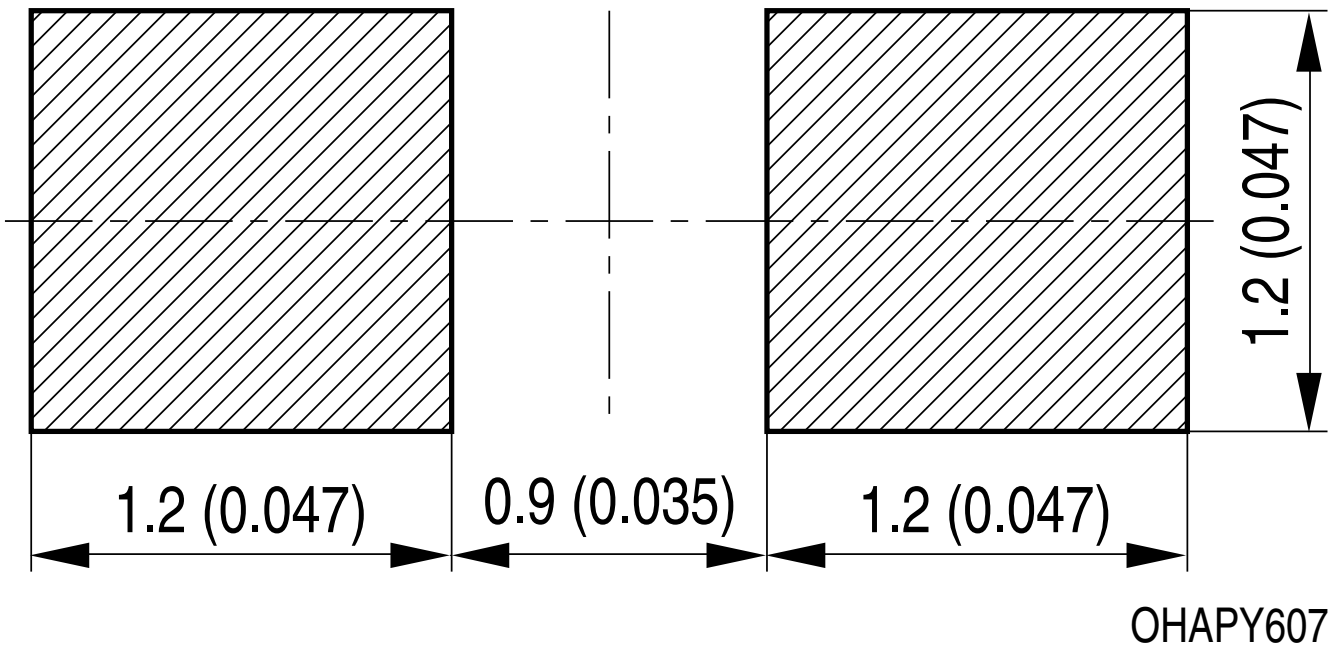

For superior solder joint connectivity results we recommend soldering under standard nitrogen atmosphere. Package not suitable for ultra sonic cleaning.

Reflow Soldering Profile

Product complies to MSL Level 2 acc. to JEDEC J-STD-020E

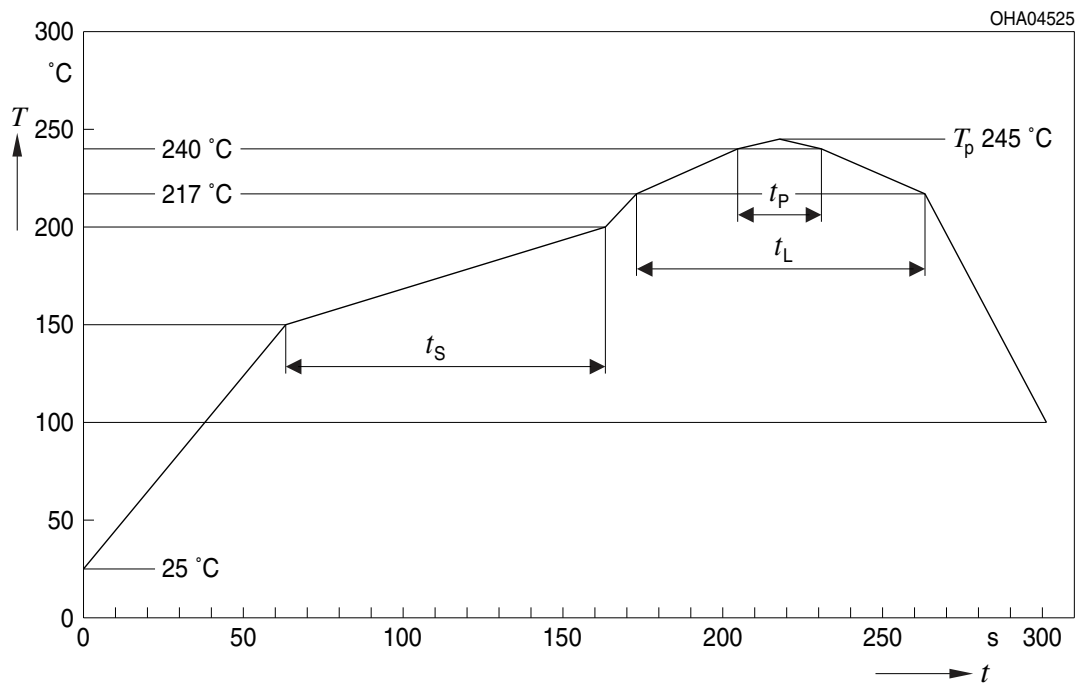

Profile Feature	Symbol	Pb-Free (SnAgCu) Assembly			Unit
		Minimum	Recommendation	Maximum	
Ramp-up rate to preheat ^{*)} 25 °C to 150 °C			2	3	K/s
Time t_s T_{Smin} to T_{Smax}	t_s	60	100	120	s
Ramp-up rate to peak ^{*)} T_{Smax} to T_p			2	3	K/s
Liquidus temperature	T_L		217		°C
Time above liquidus temperature	t_L		80	100	s
Peak temperature	T_p		245	260	°C
Time within 5 °C of the specified peak temperature $T_p - 5$ K	t_p	10	20	30	s
Ramp-down rate* T_p to 100 °C			3	6	K/s
Time 25 °C to T_p				480	s

All temperatures refer to the center of the package, measured on the top of the component

* slope calculation DT/Dt : Dt max. 5 s; fulfillment for the whole T-range

Taping ⁹⁾

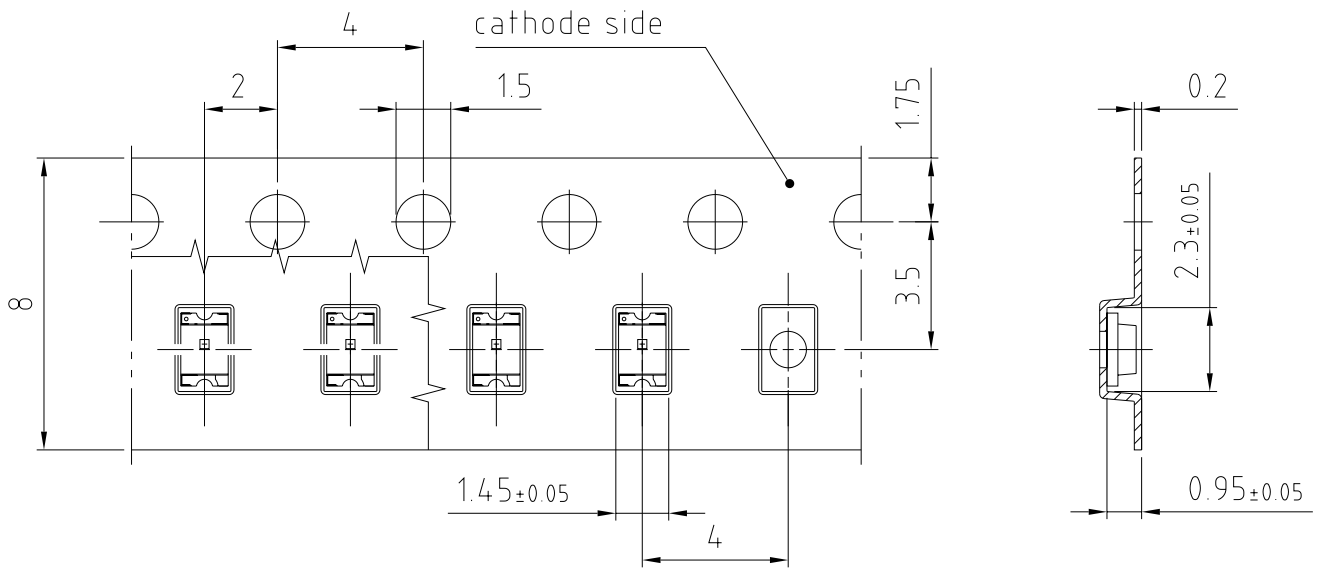

C63062-A3881-B1 -03

Tape and Reel ¹⁰⁾

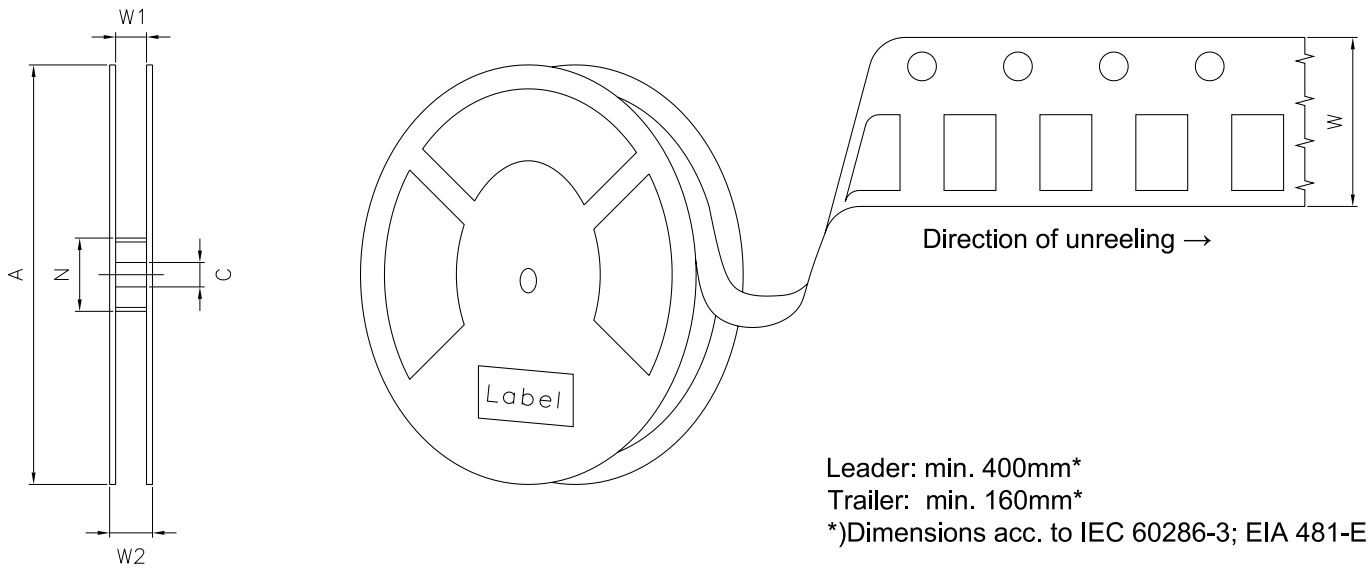

Reel Dimensions

A	W	N_{min}	W_1	W_{2max}	Pieces per PU
180 mm	$8 + 0.3 / - 0.1$ mm	60 mm	$8.4 + 2$ mm	14.4 mm	4000

Barcode-Product-Label (BPL)

OSRAM Opto Semiconductors LX XXXX BIN1: XX-XX-X-XXX-X

RoHS Compliant

(6P) BATCH NO: 1234567890 ML Temp ST
X XXX °C X

(1T) LOT NO: 1234567890 (9D) D/C: 1234

(X) PROD NO: 123456789(Q)QTY: 9999 (G) GROUP: XX-XX-X-X

Pack: RXX
DEMY XXX
X_X123_1234.1234 X



OHA04563

Dry Packing Process and Materials ⁹⁾

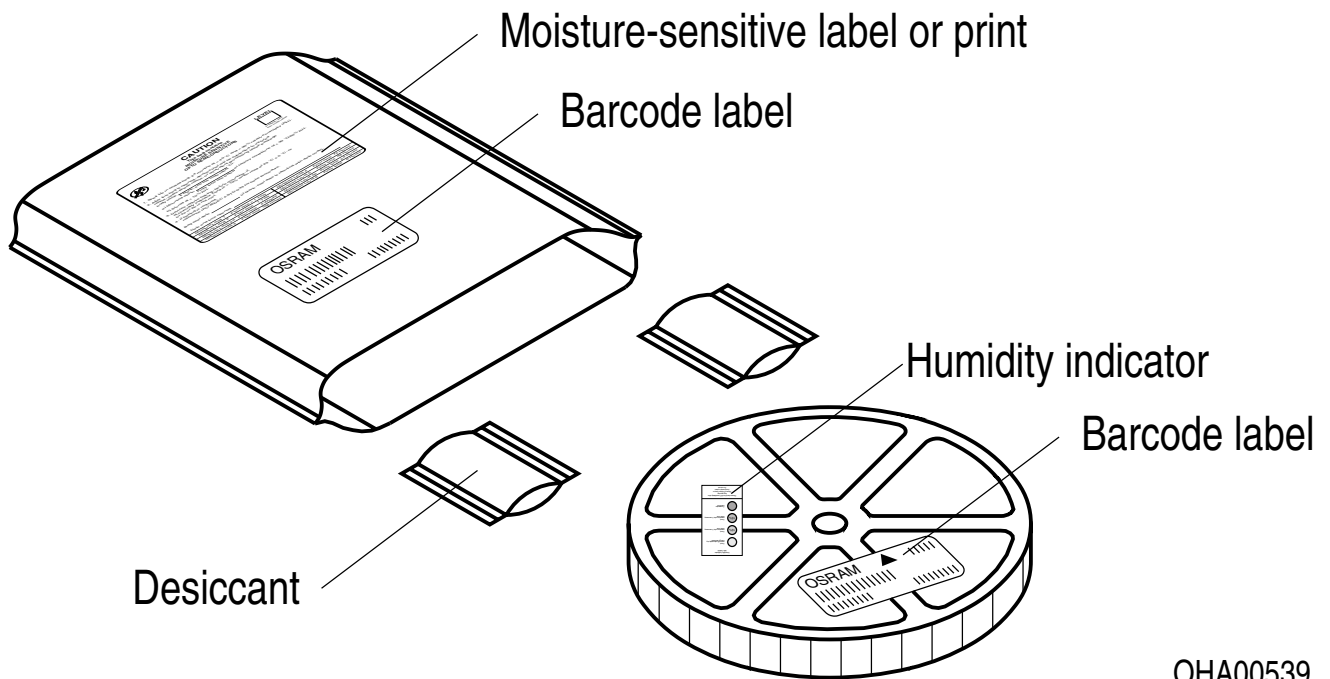

OHA00539

Moisture-sensitive product is packed in a dry bag containing desiccant and a humidity card according JEDEC-STD-033.

Schematic Transportation Box ⁹⁾

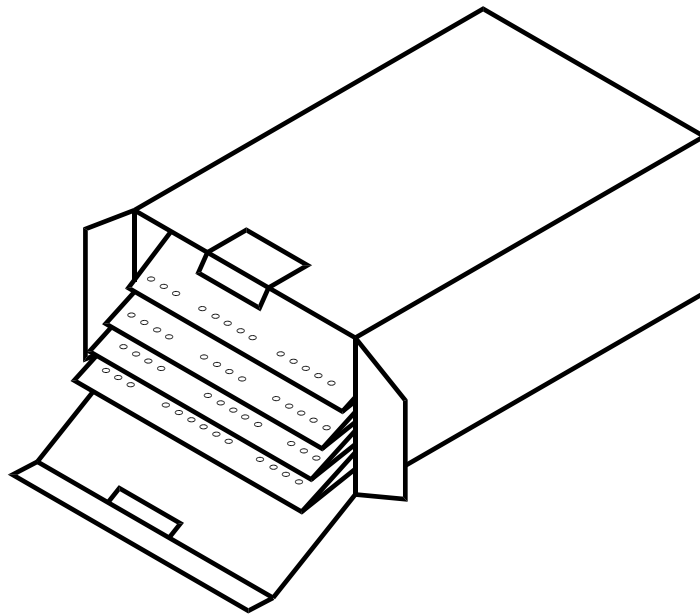

C63062-A3437-X121-01

Dimensions of Transportation Box

Width

Length

Height

260 ± 5 mm

230 ± 5 mm

85 ± 5 mm

Type Designation System

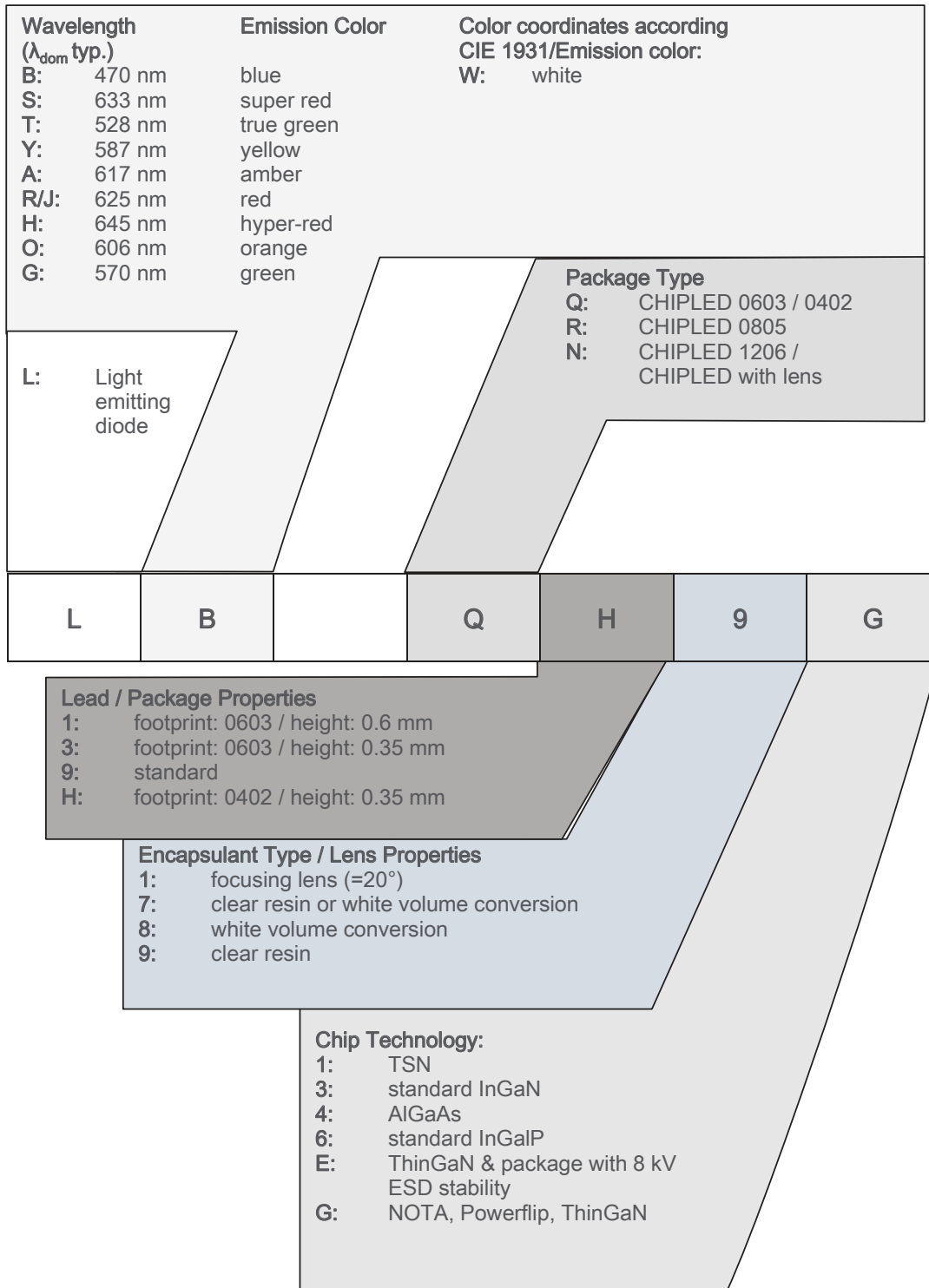

Notes

The evaluation of eye safety occurs according to the standard IEC 62471:2006 (photo biological safety of lamps and lamp systems). Within the risk grouping system of this IEC standard, the device specified in this data sheet falls into the class **exempt group (exposure time 10000 s)**. Under real circumstances (for exposure time, conditions of the eye pupils, observation distance), it is assumed that no endangerment to the eye exists from these devices. As a matter of principle, however, it should be mentioned that intense light sources have a high secondary exposure potential due to their blinding effect. When looking at bright light sources (e.g. headlights), temporary reduction in visual acuity and afterimages can occur, leading to irritation, annoyance, visual impairment, and even accidents, depending on the situation.

Subcomponents of this device contain, in addition to other substances, metal filled materials including silver. Metal filled materials can be affected by environments that contain traces of aggressive substances. Therefore, we recommend that customers minimize device exposure to aggressive substances during storage, production, and use. Devices that showed visible discoloration when tested using the described tests above did show no performance deviations within failure limits during the stated test duration. Respective failure limits are described in the IEC60810.

For further application related information please visit www.osram-os.com/appnotes

Disclaimer

Attention please!

The information describes the type of component and shall not be considered as assured characteristics. Terms of delivery and rights to change design reserved. Due to technical requirements components may contain dangerous substances.

For information on the types in question please contact our Sales Organization.

If printed or downloaded, please find the latest version on the OSRAM OS website.

Packing

Please use the recycling operators known to you. We can also help you – get in touch with your nearest sales office. By agreement we will take packing material back, if it is sorted. You must bear the costs of transport. For packing material that is returned to us unsorted or which we are not obliged to accept, we shall have to invoice you for any costs incurred.

Product and functional safety devices/applications or medical devices/applications

OSRAM OS components are not developed, constructed or tested for the application as safety relevant component or for the application in medical devices.

OSRAM OS products are not qualified at module and system level for such application.

In case buyer – or customer supplied by buyer – considers using OSRAM OS components in product safety devices/applications or medical devices/applications, buyer and/or customer has to inform the local sales partner of OSRAM OS immediately and OSRAM OS and buyer and /or customer will analyze and coordinate the customer-specific request between OSRAM OS and buyer and/or customer.

Glossary

- 1) **Brightness:** Brightness groups are tested at a current pulse duration of 25 ms and a tolerance of $\pm 11\%$.
- 2) **Reverse Operation:** Reverse Operation of 10 hours is permissible in total. Continuous reverse operation is not allowed.
- 3) **Wavelength:** Wavelengths are tested at a current pulse duration of 25 ms and a tolerance of ± 1 nm.
- 4) **Forward Voltage:** Forward voltages are tested at a current pulse duration of 1 ms and a tolerance of ± 0.1 V.
- 5) **Thermal Resistance:** $R_{th\ max}$ is based on statistic values (6σ).
- 6) **Thermal Resistance:** R_{thJA} results from mounting on PC board FR 4 (pad size ≥ 5 mm² per pad)
- 7) **Typical Values:** Due to the special conditions of the manufacturing processes of semiconductor devices, the typical data or calculated correlations of technical parameters can only reflect statistical figures. These do not necessarily correspond to the actual parameters of each single product, which could differ from the typical data and calculated correlations or the typical characteristic line. If requested, e.g. because of technical improvements, these typ. data will be changed without any further notice.
- 8) **Characteristic curve:** In the range where the line of the graph is broken, you must expect higher differences between single devices within one packing unit.
- 9) **Tolerance of Measure:** Unless otherwise noted in drawing, tolerances are specified with ± 0.1 and dimensions are specified in mm.
- 10) **Tape and Reel:** All dimensions and tolerances are specified acc. IEC 60286-3 and specified in mm.

Revision History

Version	Date	Change
1.2	2020-04-07	Taping Dimensional Drawing

Published by OSRAM Opto Semiconductors GmbH EU RoHS and China RoHS compliant product
Leibnizstraße 4, D-93055 Regensburg
www.osram-os.com © All Rights Reserved.



此产品符合欧盟 RoHS 指令的要求；
按照中国的相关法规和标准，不含有毒有害物质或元素。