

December 1992

## CMOS 8-Bit Priority Encoder

### Features

- High Voltage Type (20V Rating)
- Converts From 1 of 8 to Binary
- Provides Cascading Feature to Handle Any Number of Inputs
- Group Select Indicates One or More Priority Inputs
- Standardized Symmetrical Output Characteristics
- 100% Tested for Quiescent Current at 20V
- Maximum Input Current of 1 $\mu$ A at 18V Over Full Package Temperature Range; 100nA at 18V and +25°C
- Noise Margin (Over Full Package/Temperature Range)
  - 0.5V at VDD = 5V
  - 1.5V at VDD = 10V
  - 1.5V at VDD = 15V
- 5V, 10V and 15V Parametric Ratings
- Meets All Requirements of JEDEC Tentative Standard No. 13B, "Standard Specifications for Description of 'B' Series CMOS Devices"

### Applications

- Priority Encoder
- Binary or BCD Encoder (Keyboard Encoding)
- Floating Point Arithmetic

### Description

CD4532BMS consists of combinational logic that encodes the highest priority input (D7 - D0) to a 3-bit binary code. The eight inputs, D7 through D0, each have an assigned priority; D7 is the highest priority and D0 is the lowest. The priority encoder is inhibited when the chip-enable input E1 is low. When E1 is high, the binary representation of the highest-priority input appears on output lines Q2 - Q0, and the group select line GS is high to indicate that priority inputs are present. The enable-out (EO) is high when no priority inputs are present. If any one input is high, EO is low and all cascaded lower-order stages are disabled.

The CD4532BMS is supplied in these 16-lead outline packages:

Braze Seal DIP	H4T
Frit Seal DIP	H1E
Ceramic Flatpack	H6W

### Pinout

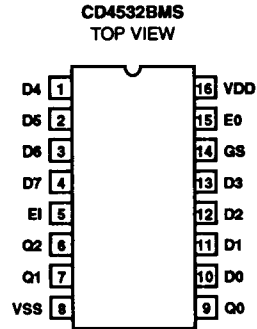

### Functional Diagram

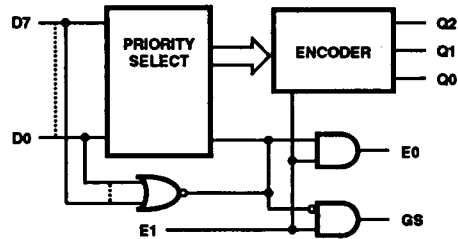

7

LOGIC

# Specifications CD4532BMS

## Absolute Maximum Ratings

DC Supply Voltage Range, (VDD) ..... -0.5V to +20V  
 (Voltage Referenced to VSS Terminals)  
 Input Voltage Range, All Inputs ..... -0.5V to VDD +0.5V  
 DC Input Current, Any One Input ..... ±10mA  
 Operating Temperature Range ..... -55°C to +125°C  
 Package Types D, F, K, H  
 Storage Temperature Range (TSTG) ..... -65°C to +150°C  
 Lead Temperature (During Soldering) ..... +265°C  
 At Distance 1/16 ± 1/32 Inch (1.59mm ± 0.79mm) from case for  
 10s Maximum

## Reliability Information

Thermal Resistance .....  $\theta_{JA}$   $\theta_{JC}$   
 Ceramic DIP and FRIT Package ..... 80°C/W 20°C/W  
 Flatpack Package ..... 70°C/W 20°C/W  
 Maximum Package Power Dissipation (PD) at +125°C  
 For  $T_A = -55^\circ\text{C}$  to +100°C (Package Type D, F, K) ..... 500mW  
 For  $T_A = +100^\circ\text{C}$  to +125°C (Package Type D, F, K) ..... Derate  
 Linearity at 12mW/°C to 200mW  
 Device Dissipation per Output Transistor ..... 100mW  
 For  $T_A =$  Full Package Temperature Range (All Package Types)  
 Junction Temperature ..... +175°C

**TABLE 1. DC ELECTRICAL PERFORMANCE CHARACTERISTICS**

PARAMETER	SYMBOL	CONDITIONS (NOTE 1)		GROUP A SUBGROUPS	TEMPERATURE	LIMITS		UNITS
						MIN	MAX	
Supply Current	IDD	VDD = 20V, VIN = VDD or GND		1	+25°C	-	10	µA
				2	+125°C	-	1000	µA
		VDD = 18V, VIN = VDD or GND		3	-55°C	-	10	µA
Input Leakage Current	IIL	VIN = VDD or GND	VDD = 20	1	+25°C	-100	-	nA
			VDD = 18V	2	+125°C	-1000	-	nA
				3	-55°C	-100	-	nA
Input Leakage Current	IIH	VIN = VDD or GND	VDD = 20	1	+25°C	-	100	nA
			VDD = 18V	2	+125°C	-	1000	nA
				3	-55°C	-	100	nA
Output Voltage	VOL15	VDD = 15V, No Load		1, 2, 3	+25°C, +125°C, -55°C	-	50	mV
Output Voltage	VOH15	VDD = 15V, No Load (Note 3)		1, 2, 3	+25°C, +125°C, -55°C	14.95	-	V
Output Current (Sink)	IOL5	VDD = 5V, VOUT = 0.4V		1	+25°C	0.53	-	mA
Output Current (Sink)	IOL10	VDD = 10V, VOUT = 0.5V		1	+25°C	1.4	-	mA
Output Current (Sink)	IOL15	VDD = 15V, VOUT = 1.5V		1	+25°C	3.5	-	mA
Output Current (Source)	IOH5A	VDD = 5V, VOUT = 4.6V		1	+25°C	-	-0.53	mA
Output Current (Source)	IOH5B	VDD = 5V, VOUT = 2.5V		1	+25°C	-	-1.8	mA
Output Current (Source)	IOH10	VDD = 10V, VOUT = 9.5V		1	+25°C	-	-1.4	mA
Output Current (Source)	IOH15	VDD = 15V, VOUT = 13.5V		1	+25°C	-	-3.5	mA
N Threshold Voltage	VNTH	VDD = 10V, ISS = -10µA		1	+25°C	-2.8	-0.7	V
P Threshold Voltage	VP TH	VSS = 0V, IDD = 10µA		1	+25°C	0.7	2.8	V
Functional	F	VDD = 2.8V, VIN = VDD or GND		7	+25°C	VOH > VDD/2	VOL < VDD/2	V
		VDD = 20V, VIN = VDD or GND		7	+25°C			
		VDD = 18V, VIN = VDD or GND		8A	+125°C			
		VDD = 3V, VIN = VDD or GND		8B	-55°C			
Input Voltage Low (Note 2)	VIL	VDD = 5V, VOH > 4.5V, VOL < 0.5V		1, 2, 3	+25°C, +125°C, -55°C	-	1.5	V
Input Voltage High (Note 2)	VIH	VDD = 5V, VOH > 4.5V, VOL < 0.5V		1, 2, 3	+25°C, +125°C, -55°C	3.5	-	V
Input Voltage Low (Note 2)	VIL	VDD = 15V, VOH > 13.5V, VOL < 1.5V		1, 2, 3	+25°C, +125°C, -55°C	-	4	V
Input Voltage High (Note 2)	VIH	VDD = 15V, VOH > 13.5V, VOL < 1.5V		1, 2, 3	+25°C, +125°C, -55°C	11	-	V

NOTES: 1. All voltages referenced to device GND, 100% testing being implemented. 3. For accuracy, voltage is measured differentially to VDD. Limit is 0.050V max.  
 2. Go/No Go test with limits applied to inputs.

## Specifications CD4532BMS

**TABLE 2. AC ELECTRICAL PERFORMANCE CHARACTERISTICS**

PARAMETER	SYMBOL	CONDITIONS (NOTE 1, 2)	GROUP A SUBGROUPS	TEMPERATURE	LIMITS		UNITS
					MIN	MAX	
Propagation Delay E1 to E0 E1 to GS	TPHL1 TPLH1	VDD = 5V, VIN = VDD or GND	9	+25°C	-	220	ns
			10, 11	+125°C, -55°C	-	297	ns
Propagation Delay E1 to QM DN to GS	TPHL2 TPLH2	VDD = 5V, VIN = VDD or GND	9	+25°C	-	340	ns
			10, 11	+125°C, -55°C	-	459	ns
Propagation Delay DN to QM	TPHL3 TPLH3	VDD = 5V, VIN = VDD or GND	9	+25°C	-	440	ns
			10, 11	+125°C, -55°C	-	594	ns
Transition Time	TTHL TTLH	VDD = 5V, VIN = VDD or GND	9	+25°C	-	200	ns
			10, 11	+125°C, -55°C	-	270	ns

**NOTES:**

1. CL = 50pF, RL = 200K, Input TR, TF < 20ns.
2. -55°C and +125°C limits guaranteed, 100% testing being implemented.

**TABLE 3. ELECTRICAL PERFORMANCE CHARACTERISTICS**

PARAMETER	SYMBOL	CONDITIONS	NOTES	TEMPERATURE	LIMITS		UNITS
					MIN	MAX	
Supply Current	IDD	VDD = 5V, VIN = VDD or GND	1, 2	-55°C, +25°C	-	5	μA
				+125°C	-	150	μA
		VDD = 10V, VIN = VDD or GND	1, 2	-55°C, +25°C	-	10	μA
				+125°C	-	300	μA
		VDD = 15V, VIN = VDD or GND	1, 2	-55°C, +25°C	-	10	μA
				+125°C	-	600	μA
Output Voltage	VOL	VDD = 5V, No Load	1, 2	+25°C, +125°C, -55°C	-	50	mV
Output Voltage	VOL	VDD = 10V, No Load	1, 2	+25°C, +125°C, -55°C	-	50	mV
Output Voltage	VOH	VDD = 5V, No Load	1, 2	+25°C, +125°C, -55°C	4.95	-	V
Output Voltage	VOH	VDD = 10V, No Load	1, 2	+25°C, +125°C, -55°C	9.95	-	V
Output Current (Sink)	IOL5	VDD = 5V, VOUT = 0.4V	1, 2	+125°C	0.36	-	mA
				-55°C	0.64	-	mA
Output Current (Sink)	IOL10	VDD = 10V, VOUT = 0.5V	1, 2	+125°C	0.9	-	mA
				-55°C	1.6	-	mA
Output Current (Sink)	IOL15	VDD = 15V, VOUT = 1.5V	1, 2	+125°C	2.4	-	mA
				-55°C	4.2	-	mA
Output Current (Source)	IOH5A	VDD = 5V, VOUT = 4.6V	1, 2	+125°C	-	-0.36	mA
				-55°C	-	-0.64	mA
Output Current (Source)	IOH5B	VDD = 5V, VOUT = 2.5V	1, 2	+125°C	-	-1.15	mA
				-55°C	-	-2.0	mA
Output Current (Source)	IOH10	VDD = 10V, VOUT = 9.5V	1, 2	+125°C	-	-0.9	mA
				-55°C	-	-1.6	mA
Output Current (Source)	IOH15	VDD = 15V, VOUT = 13.5V	1, 2	+125°C	-	-2.4	mA
				-55°C	-	-4.2	mA

## Specifications CD4532BMS

**TABLE 3. ELECTRICAL PERFORMANCE CHARACTERISTICS (Continued)**

PARAMETER	SYMBOL	CONDITIONS	NOTES	TEMPERATURE	LIMITS		UNITS
					MIN	MAX	
Input Voltage Low	VIL	VDD = 10V, VOH > 9V, VOL < 1V	1, 2	+25°C, +125°C, -55°C	-	3	V
Input Voltage High	VIH	VDD = 10V, VOH > 9V, VOL < 1V	1, 2	+25°C, +125°C, -55°C	+7	-	V
Propagation Delay E1 to E0 E1 to GS	TPHL1 TPLH1	VDD = 10V	1, 2, 3	+25°C	-	110	ns
		VDD = 15V	1, 2, 3	+25°C	-	85	ns
Propagation Delay E1 to QM DN to GS	TPHL2 TPLH2	VDD = 10V	1, 2, 3	+25°C	-	170	ns
		VDD = 15V	1, 2, 3	+25°C	-	125	ns
Propagation Delay DN to QM	TPLH3 TPHL3	VDD = 10V	1, 2, 3	+25°C	-	220	ns
		VDD = 15V	1, 2, 3	+25°C	-	160	ns
Transition Time	TTHL TTLH	VDD = 10V	1, 2, 3	+25°C	-	100	ns
		VDD = 15V	1, 2, 3	+25°C	-	80	ns
		VDD = 15V	1, 2, 3	+25°C	-	7.5	pF
Input Capacitance	CIN	Any Input	1, 2	+25°C	-	7.5	pF

**NOTES:**

1. All voltages referenced to device GND.
2. The parameters listed on Table 3 are controlled via design or process and are not directly tested. These parameters are characterized on initial design release and upon design changes which would affect these characteristics.
3. CL = 50pF, RL = 200K, Input TR, TF < 20ns.

**TABLE 4. POST IRRADIATION ELECTRICAL PERFORMANCE CHARACTERISTICS**

PARAMETER	SYMBOL	CONDITIONS	NOTES	TEMPERATURE	LIMITS		UNITS
					MIN	MAX	
Supply Current	IDD	VDD = 20V, VIN = VDD or GND	1, 4	+25°C	-	25	μA
N Threshold Voltage	VNTH	VDD = 10V, ISS = -10μA	1, 4	+25°C	-2.8	-0.2	V
N Threshold Voltage Delta	ΔVTN	VDD = 10V, ISS = -10μA	1, 4	+25°C	-	±1	V
P Threshold Voltage	VTP	VSS = 0V, IDD = 10μA	1, 4	+25°C	0.2	2.8	V
P Threshold Voltage Delta	ΔVTP	VSS = 0V, IDD = 10μA	1, 4	+25°C	-	±1	V
Functional	F	VDD = 18V, VIN = VDD or GND	1	+25°C	VOH > VDD/2	VOL < VDD/2	V
		VDD = 3V, VIN = VDD or GND					
Propagation Delay Time	TPHL TPLH	VDD = 5V	1, 2, 3, 4	+25°C	-	1.35 x +25°C Limit	ns

NOTES: 1. All voltages referenced to device GND.

3. See Table 2 for +25°C limit.

2. CL = 50pF, RL = 200K, Input TR, TF < 20ns.

4. Read and Record

**TABLE 5. BURN-IN AND LIFE TEST DELTA PARAMETERS +25°C**

PARAMETER	SYMBOL	DELTA LIMIT
Supply Current - MSI-2	IDD	± 1.0μA
Output Current (Sink)	IOL5	± 20% x Pre-Test Reading
Output Current (Source)	IOH5A	± 20% x Pre-Test Reading

## Specifications CD4532BMS

**TABLE 6. APPLICABLE SUBGROUPS**

CONFORMANCE GROUP		MIL-STD-883 METHOD	GROUP A SUBGROUPS	READ AND RECORD
Initial Test (Pre Burn-In)		100% 5004	1, 7, 9	IDD, IOL5, IOH5A
Interim Test 1 (Post Burn-In)		100% 5004	1, 7, 9	IDD, IOL5, IOH5A
Interim Test 2 (Post Burn-In)		100% 5004	1, 7, 9	IDD, IOL5, IOH5A
PDA (Note 1)		100% 5004	1, 7, 9, Deltas	
Interim Test 3 (Post Burn-In)		100% 5004	1, 7, 9	IDD, IOL5, IOH5A
PDA (Note 1)		100% 5004	1, 7, 9, Deltas	
Final Test		100% 5004	2, 3, 8A, 8B, 10, 11	
Group A		Sample 5005	1, 2, 3, 7, 8A, 8B, 9, 10, 11	
Group B	Subgroup B-5	Sample 5005	1, 2, 3, 7, 8A, 8B, 9, 10, 11, Deltas	Subgroups 1, 2, 3, 9, 10, 11
	Subgroup B-6	Sample 5005	1, 7, 9	
Group D		Sample 5005	1, 2, 3, 8A, 8B, 9	Subgroups 1, 2, 3

NOTE: 1. 5% Parametric, 3% Functional; Cumulative for Static 1 and 2.

**TABLE 7. TOTAL DOSE IRRADIATION**

CONFORMANCE GROUPS	MIL-STD-883 METHOD	TEST		READ AND RECORD	
		PRE-IRRAD	POST-IRRAD	PRE-IRRAD	POST-IRRAD
Group E Subgroup 2	5005	1, 7, 9	Table 4	1, 9	Table 4

**TABLE 8. BURN-IN AND IRRADIATION TEST CONNECTIONS**

FUNCTION	OPEN	GROUND	VDD	9V ± 0.5V	OSCILLATOR	
					50kHz	25kHz
Static Burn-In 1 (Note 1)	6, 7, 9, 14, 15	1 - 5, 8, 10 - 13	16			
Static Burn-In 2 (Note 1)	6, 7, 9, 14, 15	8	1 - 5, 10 - 13, 16			
Dynamic Burn-In (Note 1)	-	8	5, 16	6, 7, 9, 14, 15	1 - 4, 10 - 13	
Irradiation (Note 2)	6, 7, 9, 14, 15	8	1 - 5, 10 - 13, 16			

NOTES:

- Each pin except VDD and GND will have a series resistor of 10K ± 5%, VDD = 18V ± 0.5V
- Each pin except VDD and GND will have a series resistor of 47K ± 5%; Group E, Subgroup 2, sample size is 4 dice/wafer, 0 failures, VDD = 10V ± 0.5V

# CD4532BMS

## Logic Diagram

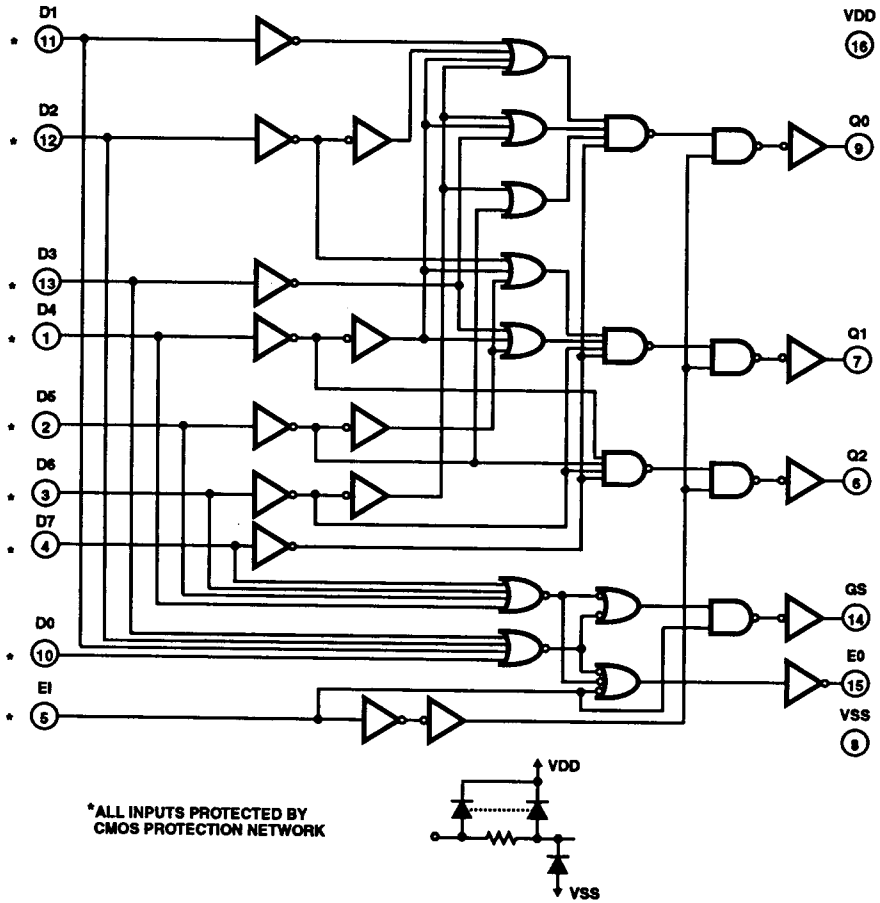

FIGURE 1. CD4532BMS LOGIC DIAGRAM

### TRUTH TABLE

INPUT									OUTPUT				
E1	D7	D6	D5	D4	D3	D2	D1	D0	GS	Q2	Q1	Q0	E0
0	X	X	X	X	X	X	X	X	0	0	0	0	0
1	0	0	0	0	0	0	0	0	0	0	0	0	1
1	1	X	X	X	X	X	X	X	1	1	1	1	0
1	0	1	X	X	X	X	X	X	1	1	1	0	0
1	0	0	1	X	X	X	X	X	1	1	0	1	0
1	0	0	0	1	X	X	X	X	1	1	0	0	0
1	0	0	0	0	1	X	X	X	1	0	1	1	0
1	0	0	0	0	0	1	X	X	1	0	1	0	0
1	0	0	0	0	0	0	1	X	1	0	0	1	0
1	0	0	0	0	0	0	0	1	1	0	0	0	0

X = Don't Care

Logic 1 = High

Logic 0 = Low

Typical Performance Characteristics

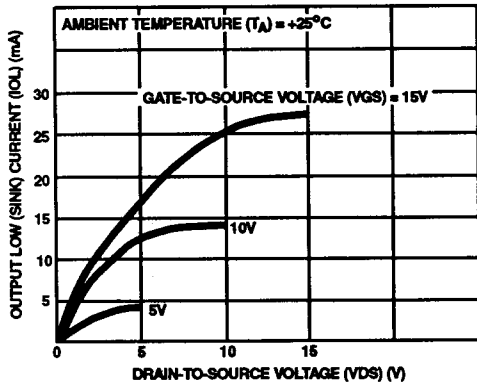

FIGURE 2. TYPICAL OUTPUT LOW (SINK) CURRENT CHARACTERISTICS

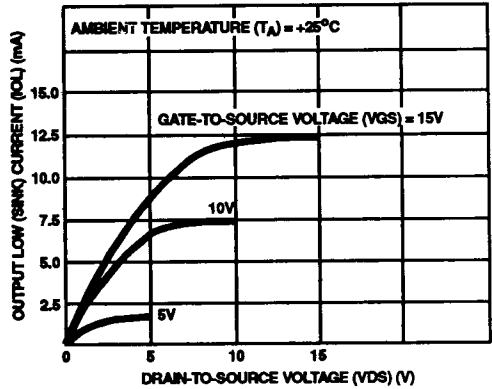

FIGURE 3. MINIMUM OUTPUT LOW (SINK) CURRENT CHARACTERISTICS

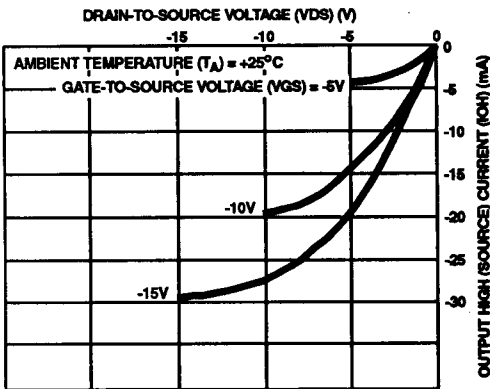

FIGURE 4. TYPICAL OUTPUT HIGH (SOURCE) CURRENT CHARACTERISTICS

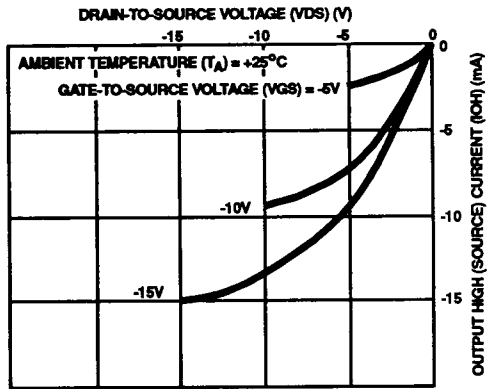

FIGURE 5. MINIMUM OUTPUT HIGH (SOURCE) CURRENT CHARACTERISTICS

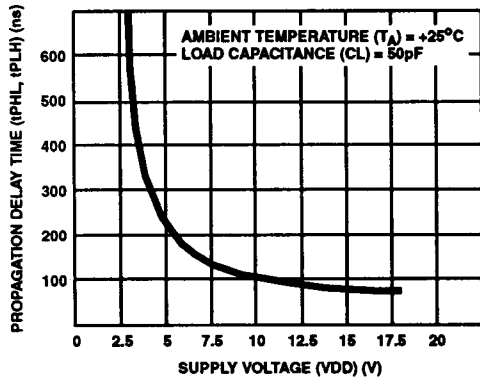

FIGURE 6. TYPICAL PROPAGATION DELAY (DN TO QM) vs SUPPLY VOLTAGE

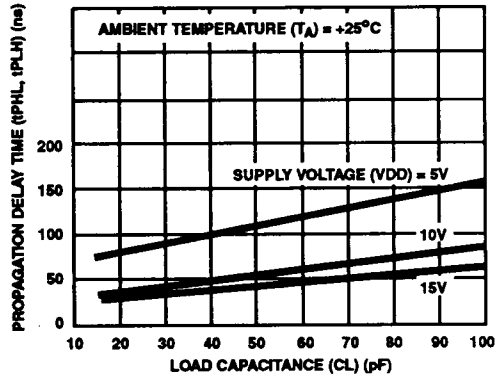

FIGURE 7. TYPICAL PROPAGATION DELAY (E1 TO GS, E1 TO EQ) vs LOAD CAPACITANCE

Typical Performance Characteristics (Continued)

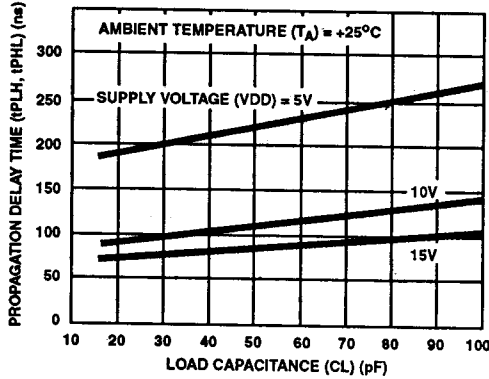

FIGURE 8. TYPICAL PROPAGATION DELAY (DN TO QM) vs LOAD CAPACITANCE

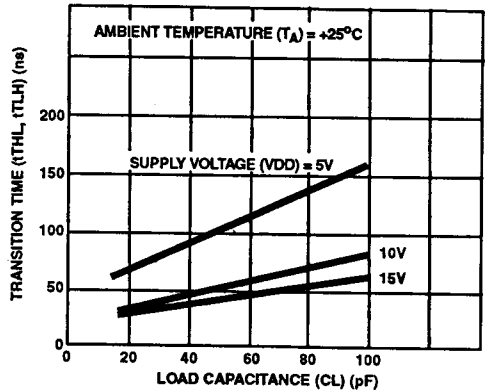

FIGURE 9. TYPICAL TRANSITION TIME vs LOAD CAPACITANCE

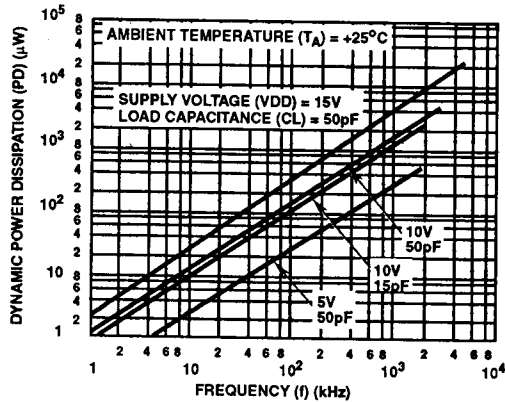

FIGURE 10. TYPICAL DYNAMIC POWER DISSIPATION vs FREQUENCY

Applications

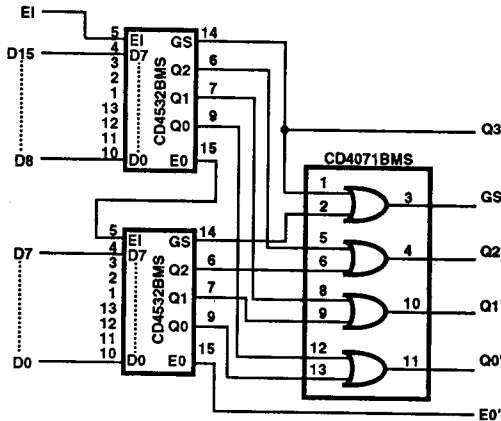

FIGURE 11. 16-LEVEL PRIORITY ENCODER



# CD4532BMS

## Applications (Continued)

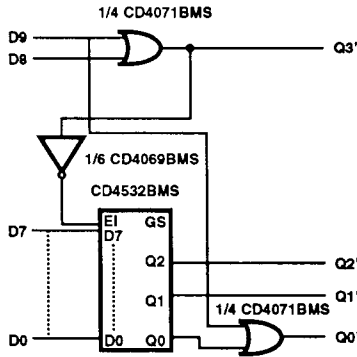

FIGURE 12. 0-TO-9 KEYBOARD ENCODER

### TRUTH TABLE

INPUT										OUTPUT				
D9	D8	D7	D6	D5	D4	D3	D2	D1	D0	GS	Q3'	Q2'	Q1'	Q0'
1	X	X	X	X	X	X	X	X	X	0	1	0	0	1
0	1	X	X	X	X	X	X	X	X	0	1	0	0	0
0	0	1	X	X	X	X	X	X	X	1	0	1	1	1
0	0	0	1	X	X	X	X	X	X	1	0	1	1	0
0	0	0	0	1	X	X	X	X	X	1	0	1	0	1
0	0	0	0	0	1	X	X	X	X	1	0	1	0	0
0	0	0	0	0	0	1	X	X	X	1	0	0	1	1
0	0	0	0	0	0	0	1	X	X	1	0	0	1	0
0	0	0	0	0	0	0	0	1	X	1	0	0	0	1
0	0	0	0	0	0	0	0	0	1	1	0	0	0	0

X = Don't Care

Logic 1 = High

Logic 0 = Low

### Chip Dimensions and Pad Layout

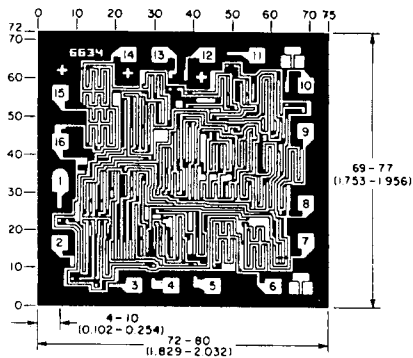

Dimensions in parenthesis are in millimeters and are derived from the basic inch dimensions as indicated. Grid graduations are in mils ( $10^{-3}$  inch).

**METALLIZATION:** Thickness:  $11\text{k}\text{\AA} - 14\text{k}\text{\AA}$ , AL.  
**PASSIVATION:**  $10.4\text{k}\text{\AA} - 15.6\text{k}\text{\AA}$ , Silane  
**BOND PADS:** 0.004 inches X 0.004 inches MIN  
**DIE THICKNESS:** 0.0198 inches - 0.0218 inches