

G3VM-61PR□/71PR/81PR/101PR

MOS FET Relays USOP Package with High Load voltage

USOP Package with High Load voltage

- Load voltage 60V/75V/80V/100V

RoHS Compliant

Refer to "Common Precautions".

Application Examples

- Semiconductor test equipment
- Communication equipment
- Test & measurement equipment
- Data loggers

Package (Unit : mm, Average)

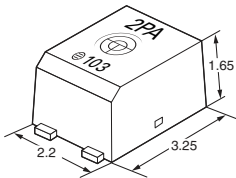

Note: The actual product is marked differently from the image shown here.

Model Number Legend

G3VM-□□□□□
1 2 3 4 5

1. Load Voltage

- 6: 60V
- 7: 75V
- 8: 80V
- 10: 100V

2. Contact form

- 1: 1a (SPST-NO)

3. Package type

- P: USOP 4 pin

4. Additional functions

- R: Low On-resistance

5. Other informations

When specifications overlap, serial code is added in the recorded order.



Note: The actual product is marked differently from the image shown here.

Ordering Information

Package type	Contact form	Terminals	Load voltage (peak value) *	Continuous load current (peak value) *	Packing/Tape cut		Packing/Tape & reel	
					Model	Minimum package quantity	Model	Minimum package quantity
USOP4	1a (SPST-NO)	Surface-mounting Terminals	60V	120mA	G3VM-61PR1	1 pc.	G3VM-61PR1(TR05)	500 pcs.
			75V	400mA	G3VM-61PR		G3VM-61PR(TR05)	
			80V	120mA	G3VM-71PR		G3VM-71PR(TR05)	
			100V	100mA	G3VM-81PR		G3VM-81PR(TR05)	
					G3VM-101PR		G3VM-101PR(TR05)	

Note: When ordering tape packing, add "(TR05)" (500pcs/reel) to the model number.
Ask your OMRON representative for orders under 500 pcs. We can supply products with the tape already cut.
Tape-cut USOPs are packaged without humidity resistance. Use manual soldering to mount them.
Refer to common precautions.

* The AC peak and DC value are given for the load voltage and continuous load current.

Absolute Maximum Ratings (Ta = 25°C)

Item	Symbol	G3VM-61PR1	G3VM-61PR	G3VM-71PR	G3VM-81PR	G3VM-101PR	Unit	Measurement conditions
LED forward current	IF	50					mA	
LED forward current reduction rate	ΔIF/°C	-0.5					mA/°C	Ta≥25°C
LED reverse voltage	VR	5					V	
Connection temperature	TJ	125					°C	
Load voltage (AC peak/DC)	VOFF	60	75	80	100		V	
Continuous load current (AC peak/DC)	Io	120	400	120	100		mA	
ON current reduction rate	ΔIo/°C	-12	-4	-1.2	-1		mA/°C	Ta≥25°C
Pulse ON current	Iop	360	1,200	360	300		mA	t=100ms, Duty=1/10
Connection temperature	TJ	125					°C	
Dielectric strength between I/O *	VI-O	500					Vrms	AC for 1 min
Ambient operating temperature	Ta	-40~+85					°C	With no icing or condensation
Ambient storage temperature	Tstg	-40~+125					°C	
Soldering temperature	-	260					°C	10s

* The dielectric strength between the input and output was checked by applying voltage between all pins as a group on the LED side and all pins as a group on the light-receiving side.

USOP

G3VM-61PR□/71PR/81PR/101PR

■Electrical Characteristics (Ta = 25°C)

Item		Symbol	G3VM-61PR1	G3VM-61PR	G3VM-71PR	G3VM-81PR	G3VM-101PR	Unit	Measurement conditions	
Input	LED forward voltage	V _F	Minimum				1.0		V	I _F =10mA
			Typical				1.15			
			Maximum				1.3			
	Reverse current	I _R	Maximum				10		μA	V _R =5V
	Capacity between terminals	C _T	Typical				15		pF	V=0, f=1MHz
	Trigger LED forward current	I _{FT}	Typical	1.0	0.5	0.6	0.5	mA	I _o =100mA	
Output	Release LED forward current	I _{FC}	Minimum				0.1		mA	I _{OFF} =10μA
			0.1	0.2	0.1	0.1				
	Maximum resistance with output ON	R _{ON}	Typical	10	1	7	8	Ω	G3VM-61PR : I _F =5mA, I _o =400mA Others : I _F =5mA, I _o =Continuous load current ratings, t<1s	
			Maximum	15	1.5	12	14			
	Current leakage when the relay is open	I _{LEAK}	Maximum	1			0.02	0.2	nA	V _{OFF} =Load voltage ratings
			Typical	0.7	20	30	5	6		
Capacity between terminals	C _{OFF}	Maximum	1.3	-		7	8	pF	G3VM-61PR : V=0, f=1MHz, t<1s Others : V=0, f=100MHz, t<1s	
		Typical	0.4	0.3	0.4					
Capacity between I/O terminals	C _{I-O}	Typical	0.4	0.3	0.4		pF	f=1MHz, V _s =0V		
Insulation resistance between I/O terminals	R _{I-O}	Maximum	1000				MΩ	V _{I-O} =500VDC, R _{oH} ≤60%		
		Typical	10 ⁸							
Turn-ON time	t _{ON}	Typical	0.04	0.3	0.4	0.14	0.12	ms	I _F =5mA, R _L =200Ω, V _{DD} =20V *	
		Maximum	0.2	0.5	2	0.5	0.3			
Turn-OFF time	t _{OFF}	Typical	0.12	0.3	0.2	0.16	0.18	ms	I _F =5mA, R _L =200Ω, V _{DD} =20V *	
		Maximum	0.2	0.5	1	0.2	0.3			

* Turn-ON and Turn-OFF Times

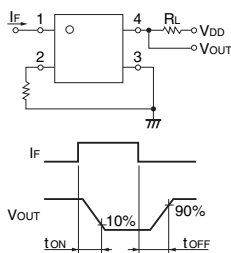

■Recommended Operating Conditions

For usage with high reliability, Recommended Operation Conditions is a measure that takes into account the derating of Absolute Maximum Ratings and Electrical Characteristics.

Each item on this list is an independent condition, so it is not simultaneously satisfy several conditions.

Item	Symbol		G3VM-61PR1	G3VM-61PR	G3VM-71PR	G3VM-81PR	G3VM-101PR	Unit
Load voltage (AC peak/DC)	V _{DD}	Maximum	48		60	64	80	V
Operating LED forward current	I _F	Minimum	5				mA	
		Typical	7.5					
		Maximum	20					
Continuous load current (AC peak/DC)	I _o	Maximum	120	400	120	100		
Ambient operating temperature	T _a	Minimum	-20				°C	
		Maximum	65					

Engineering Data

LED forward current vs. Ambient temperature

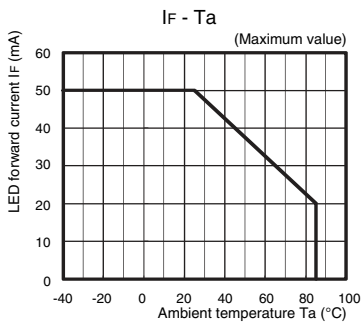

Continuous load current vs. Ambient temperature

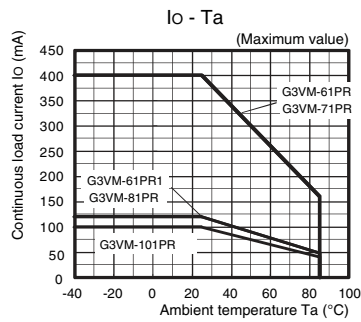

LED forward current vs. LED forward voltage

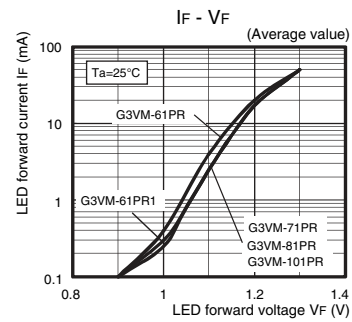

Continuous load current vs. On-state voltage

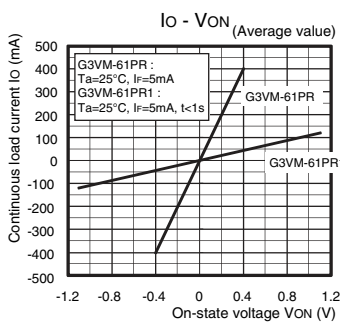

G3VM-71PR/81PR/101PR

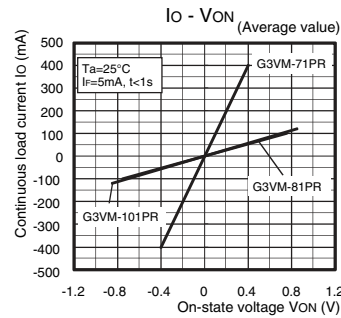

On-state resistance vs. Ambient temperature

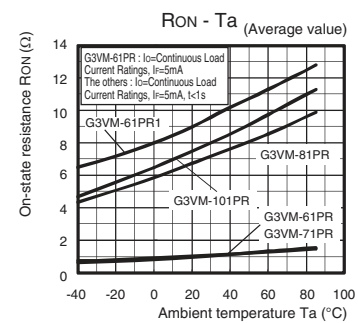

Trigger LED forward current vs. Ambient temperature

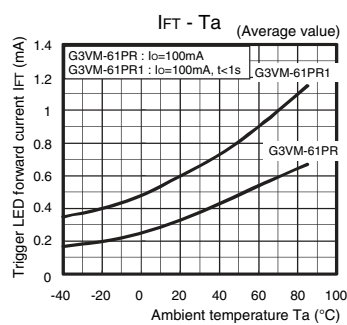

G3VM-71PR/81PR/101PR

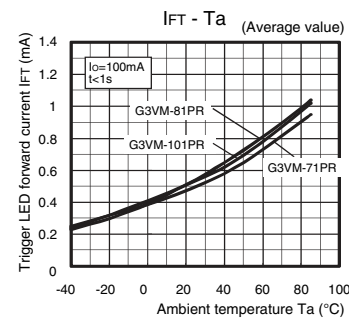

Turn ON, Turn OFF time vs. LED forward current

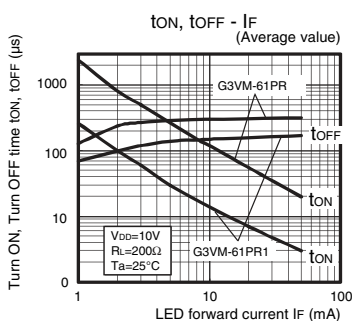

G3VM-71PR/81PR/101PR

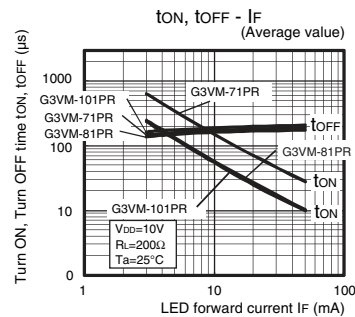

Engineering Data

Turn ON, Turn OFF time vs. Ambient temperature

G3VM-61PR/61PR1

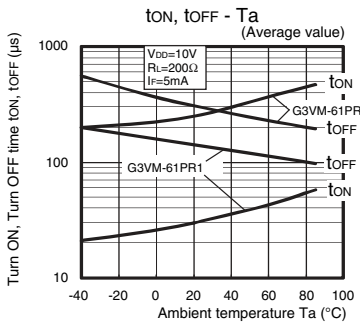

G3VM-71PR/81PR/101PR

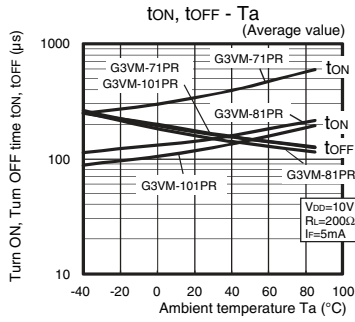

Current leakage vs. Load voltage

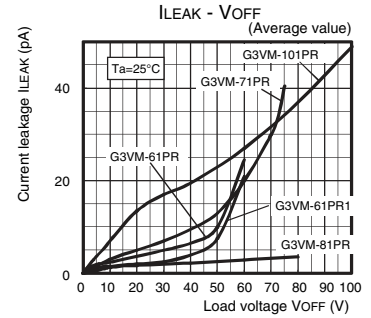

Output terminal capacitance vs. Load voltage

G3VM-61PR/61PR1

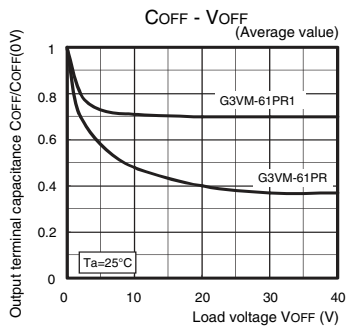

G3VM-71PR/81PR/101PR

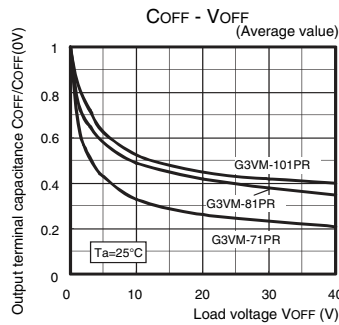

Current leakage vs. Ambient temperature

G3VM-71PR

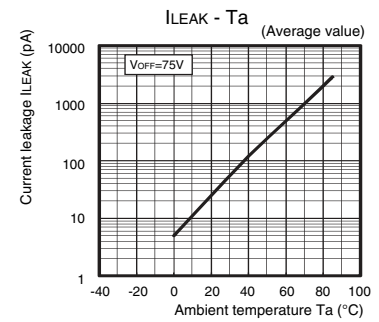

■Appearance / Terminal Arrangement / Internal Connections

■Appearance

USOP (Ultra Small Outline Package)
USOP4 pin

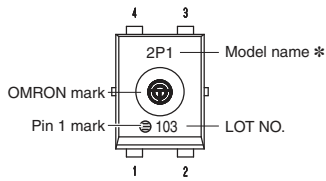

* Actual model name marking for each model

Model	Marking
G3VM-61PR1	6P1
G3VM-61PR	6P0
G3VM-71PR	7P0
G3VM-81PR	8P0
G3VM-101PR	AP0

■Terminal Arrangement/Internal Connections (Top View)

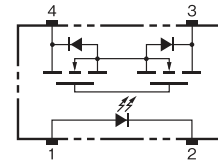

Note: The actual product is marked differently from the image shown here.

■Dimensions (Unit: mm)

Surface-mounting Terminals

Weight: 0.03g

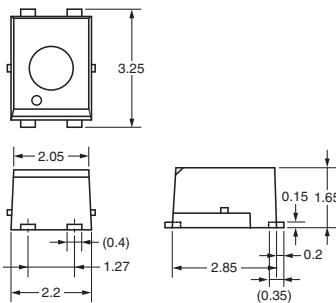
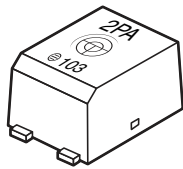

Unless otherwise specified, the dimensional tolerance is ± 0.2 mm.

Actual Mounting Pad Dimensions

(Recommended Value, Top View)

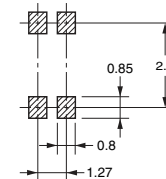

Unless otherwise specified, the dimensional tolerance is ± 0.2 mm.

Note: The actual product is marked differently from the image shown here.

■Approved Standards

UL recognized

Approved Standards	Contact form	File No.
UL recognized	1a (SPST-NO)	E80555

■Safety Precautions

- Refer to "Common Precautions" for all G3VM models.

Please check each region's Terms & Conditions by region website.

OMRON Corporation
Electronic and Mechanical Components Company

Regional Contact

Americas
<https://www.components.omron.com/>
Asia-Pacific
<https://ecb.omron.com.sg/>
Korea
<https://www.omron-ecb.co.kr/>

Europe
<http://components.omron.eu/>
China
<https://www.ecb.omron.com.cn/>
Japan
<https://www.omron.co.jp/ecb/>