



QTY CKTS	DIM "A"		DIM "B"		DIM "C"		DIM "D"		MATERIAL #	MATERIAL #	MATERIAL #	MATERIAL #
	MM	INCH	MM	INCH	MM	INCH	MM	INCH	STD OPT.	-49 OPT.	-50 OPT.	-56 OPT.
2	40.3	1.59	28.58	1.125	21.1	0.83	9.53	0.375	387204702	387205002	387205302	387290792
3	49.8	1.96	38.10	1.500	30.6	1.21	19.05	0.750	387204703	387205003	387205303	--
4	59.3	2.34	47.63	1.875	40.2	1.58	28.58	1.125	387204704	387205004	387205304	--
5	68.8	2.71	57.15	2.250	49.7	1.96	38.10	1.500	387204705	387205005	387205305	387290295
6	78.4	3.09	66.66	2.625	59.2	2.33	47.63	1.875	387204706	387205006	387205306	387290984
7	87.9	3.46	76.20	3.000	68.8	2.71	57.15	2.250	387204707	387205007	387205307	--
8	97.4	3.84	85.73	3.375	78.3	3.08	66.66	2.625	387204708	387205008	387205308	387290490
9	106.9	4.21	95.25	3.750	87.8	3.46	76.20	3.000	387204709	387205009	387205309	--
10	116.5	4.59	104.78	4.125	97.3	3.83	85.73	3.375	387204710	387205010	387205310	--
11	126.0	4.96	114.30	4.500	106.9	4.21	95.25	3.750	387204711	387205011	387205311	387290876
12	135.5	5.34	123.83	4.875	116.4	4.58	104.78	4.125	387204712	387205012	387205312	387291384
13	145.0	5.71	133.35	5.250	125.9	4.96	114.30	4.500	387204713	387205013	387205313	--
14	154.6	6.09	142.88	5.625	135.5	5.33	123.83	4.875	387204714	387205014	387205314	--
15	164.1	6.46	152.40	6.000	145.0	5.71	133.35	5.250	387204715	387205015	387205315	--
16	173.6	6.84	161.93	6.375	154.5	6.08	142.88	5.625	387204716	387205016	387205316	--
17	183.1	7.21	171.45	6.750	164.1	6.46	152.40	6.000	387204717	387205017	387205317	--
18	192.7	7.59	180.98	7.125	173.6	6.83	161.93	6.375	387204718	387205018	387205318	--
19	202.2	7.96	190.50	7.500	183.1	7.21	171.45	6.750	387204719	387205019	387205319	--
20	211.7	8.34	200.03	7.875	192.6	7.58	180.98	7.125	387204720	387205020	387205320	--
21	221.2	8.71	209.55	8.250	202.2	7.96	190.50	7.500	387204721	387205021	387205321	--
22	230.8	9.09	219.08	8.625	211.7	8.33	200.03	7.875	387204722	387205022	387205322	--
23	240.3	9.46	228.60	9.000	221.2	8.71	209.55	8.250	387204723	387205023	387205323	--
24	249.8	9.84	238.13	9.375	230.8	9.08	219.08	8.625	387204724	387205024	387205324	--
25	259.3	10.21	247.65	9.750	240.3	9.46	228.60	9.000	387204725	387205025	387205325	--
26	268.9	10.59	257.18	10.125	249.8	9.83	238.13	9.375	387204726	387205026	387205326	--

SEE SHEET ONE
 EC NO: WNA2011-0086
 DRAWN: JENC INAS 2011/03/03
 CHKD: JMACNEIL
 APPR: JMACNEIL 2011/05/06

QUALITY SYMBOLS
 =0
 =0

GENERAL TOLERANCES (UNLESS SPECIFIED)

	mm	INCH
4 PLACES	± .005	± .0005
3 PLACES	± .010	± .0010
2 PLACES	± 0.13	± .01
1 PLACE	± 0.3	± .01

ANGULAR ± 2 °

DRAFT WHERE APPLICABLE
 MUST REMAIN
 WITHIN DIMENSIONS

DIMENSION STYLE
MM/IN

DRAWN BY DATE
 JENC INAS 2008/04/18

CHECKED BY DATE
 CYORK 2008/04/21

APPROVED BY DATE
 JMACNEIL 2008/04/24

MATERIAL NO.
SEE CHART

SCALE
2:1

DESIGN UNITS
INCH

THIRD ANGLE PROJECTION

TITLE
**9.53/.375 SR BTS
 INS. PC W/MTG ENDS**

MOLEX INCORPORATED

DOCUMENT NO.
SD-38720-011

SHEET NO.
2 OF 2

THIS DRAWING CONTAINS INFORMATION THAT IS PROPRIETARY TO MOLEX INCORPORATED AND SHOULD NOT BE USED WITHOUT WRITTEN PERMISSION

PART NUMBER DATA								
CIRCUITS	A IN	mm	B IN	mm	C IN	mm	D IN	mm
2	1.58	40.2	1.125	28.58	.83	21.1	.375	9.52
3	1.96	49.7	1.500	38.10	1.21	30.7	.750	19.05
4	2.33	59.2	1.875	47.63	1.58	40.2	1.125	28.58
5	2.71	68.7	2.250	57.15	1.96	49.7	1.500	38.10
6	3.08	78.3	2.625	66.68	2.33	59.2	1.875	47.63
7	3.46	87.8	3.000	76.20	2.71	68.8	2.250	57.15
8	3.83	97.3	3.375	85.73	3.08	78.3	2.625	66.68
9	4.21	106.8	3.750	95.25	3.46	87.8	3.000	76.20
10	4.58	116.4	4.125	104.78	3.83	97.3	3.375	85.73
11	4.96	125.9	4.500	114.30	4.21	106.9	3.750	95.25
12	5.33	135.4	4.875	123.83	4.58	116.4	4.125	104.78
13	5.71	144.9	5.250	133.35	4.96	125.9	4.500	114.30
14	6.08	154.5	5.625	142.88	5.33	135.4	4.875	123.83
15	6.46	164.0	6.000	152.40	5.71	145.0	5.250	133.35
16	6.83	173.5	6.375	161.93	6.08	154.5	5.625	142.88
17	7.21	183.0	6.750	171.45	6.46	164.0	6.000	152.40
18	7.58	192.6	7.125	180.98	6.83	173.5	6.375	161.93
19	7.96	202.1	7.500	190.50	7.21	183.1	6.750	171.45
20	8.33	211.6	7.875	200.03	7.58	192.6	7.125	180.98
21	8.71	221.1	8.250	209.55	7.96	202.1	7.500	190.50
22	9.08	230.7	8.625	219.08	8.33	211.6	7.875	200.03
23	9.46	240.2	9.000	228.60	8.71	221.2	8.250	209.55
24	9.83	249.7	9.375	238.13	9.08	230.7	8.625	219.08
25	10.21	259.2	9.750	247.65	9.46	240.2	9.000	228.60
26	10.58	268.8	10.125	257.18	9.83	249.7	9.375	238.13

- NOTES:
- MATERIAL: SEE TABLE
 - FINISH: SEE TABLE
 - ELECTRICAL SPECS:
MAX VOLTAGE: 300V
MAX CURRENT: 15A (6-32 BINDING HD SCREW STD, -49 & -56 OPT)
MAX CURRENT: 25A (6-32 WIRE CLAMP SCREW -50 OPT)
 - WIRE RANGE: 22 TO 14 AWG FOR STD, -49 & -56 OPT
WIRE RANGE: 22 TO 12 AWG FOR STD, -50 OPT
 - SCREW TIGHTENING TORQUE: 12 IN LBS.
 - WIRE STRIP: 5/16 (8mm)
 - OPERATING TEMP: 110°F
 - PRODUCT SPEC: PS-38710-001
 - PART IS RoHS COMPLIANT
 - XX EQUALS NUMBER OF CIRCUITS

7	XX	SCREW (-56 OPT)	ST. STEEL	PASSIVATED
6	XX	SCREW/CLAMP WASHER (-50 OPT)	STEEL	ZINC PLATED
5	XX	SCREW (-49 OPT)	BRASS	NICKEL PLATED
4	XX	SCREW (STD OPT)	STEEL	ZINC PLATED
3	2	MOUNTING PLATE	BRASS	NICKEL PLATED
2	XX	TERMINAL, WIRE WRAP	BRASS	TIN PLATED
1	1	BARRIER STRIP, INSULATED	PBT	BLACK
ITEM	QTY	DESCRIPTION	MATERIAL	FINISH

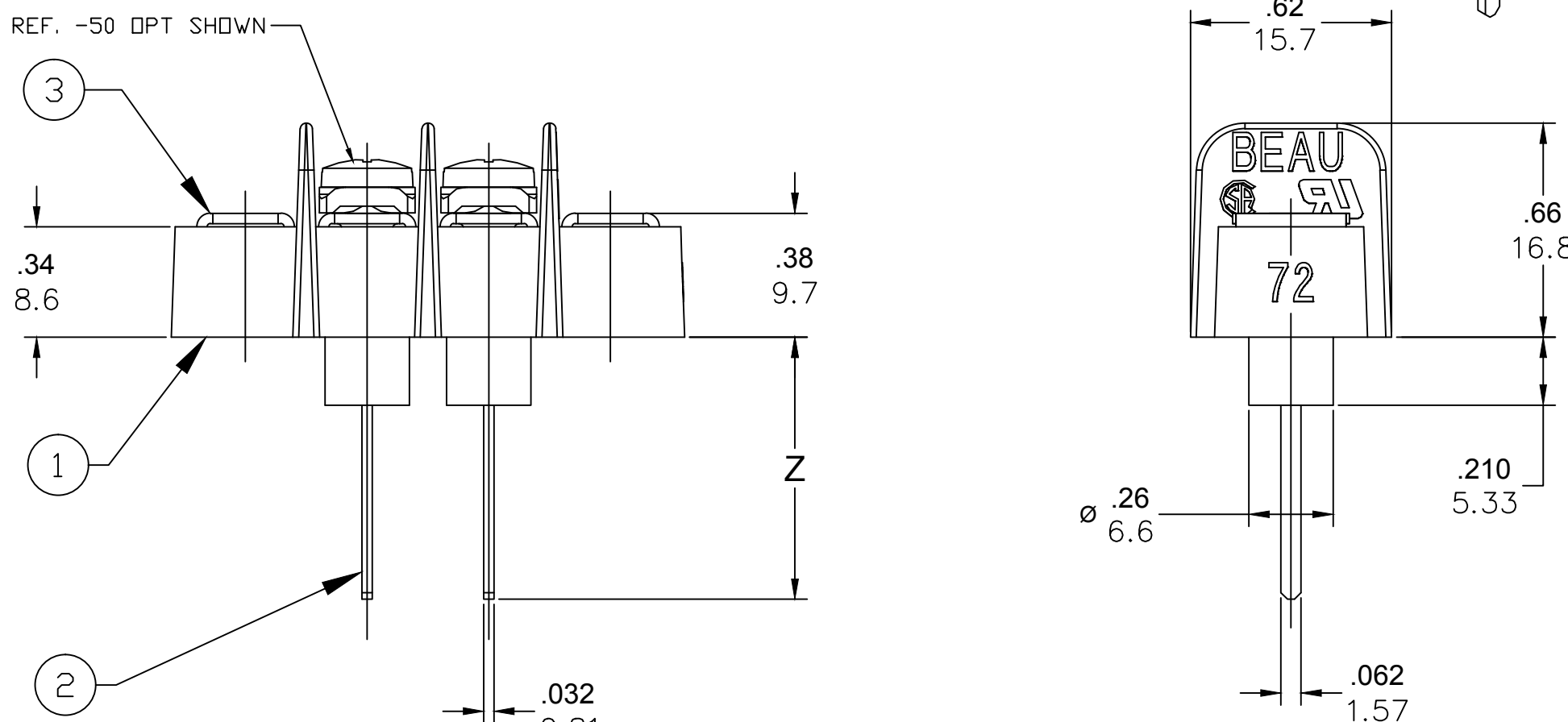
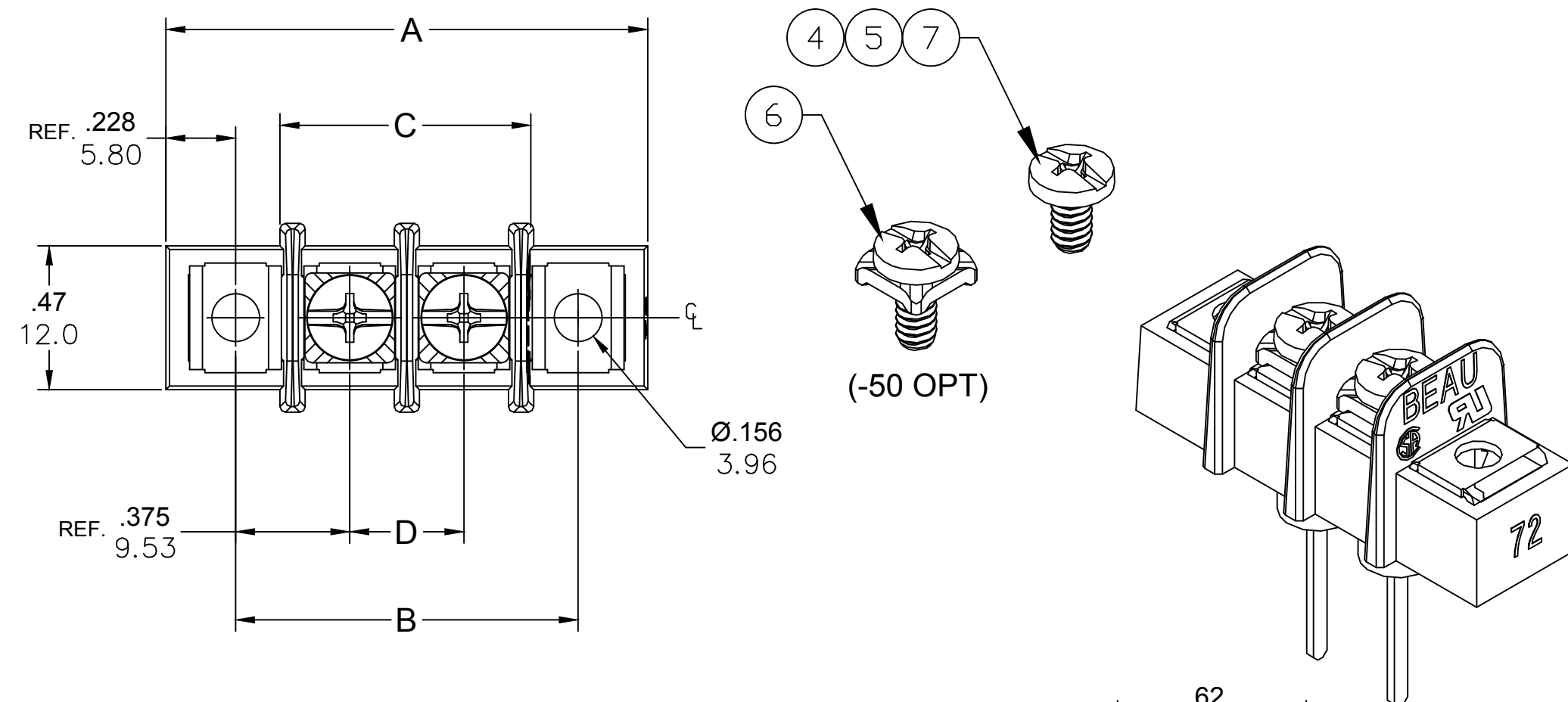

ENGINEERING NUMBER LEGEND

72 3 XX-Y-Z
 SERIES
 TERMINAL STYLE
 NO. OF CIRCUITS
 BLANK: .47 STD TAIL LENGTH
 -55: .54 TAIL LENGTH
 -75: .75 TAIL LENGTH
 -81: .81 TAIL LENGTH
 SCREW TYPE
 BLANK: STD STEEL
 -49: BRASS NI PLATE
 -50: SCREW W/CLAMP WASHER
 -56: ST. STEEL SCREW

RELEASED EC NO: ICG2016-0185 DRWN: RSTONE 2015/08/03 CHKD: B ARDEN APPR: BRUPERT 2015/08/12	QUALITY SYMBOL	GENERAL TOLERANCES (UNLESS SPECIFIED)	DIMENSION STYLE	SCALE	DESIGN UNITS	THIRD ANGLE PROJECTION
	$\nabla=0$ $\nabla C=0$	mm INCH 4 PLACES ±--- ±--- 3 PLACES ±--- ±.005 2 PLACES ±0.13 ±.01 1 PLACE ±0.3 ±---	IN/MM	---	INCH	
		ANGULAR ±1°	DRAWN BY	DATE	TITLE	
		DRAFT WHERE APPLICABLE MUST REMAIN WITHIN DIMENSIONS	RSTONE	2015/08/03	BARRIER TERMINAL STRIP WIRE WRAP	
			CHECKED BY	DATE		
			B ARDEN	---		
			APPROVED BY	DATE		
			BRUPERT	2015/08/12		
			MATERIAL NO.	---		
			SIZE	THIS DRAWING CONTAINS INFORMATION THAT IS PROPRIETARY TO MOLEX INCORPORATED AND SHOULD NOT BE USED WITHOUT WRITTEN PERMISSION		
			C			
				MOLEX	DOCUMENT NO.	SHEET NO.
					SD-38729-078	1 OF 1