

Selector Chart For Fuses

Resettable Polymeric PTC					
	<i>Fuses cross to competitive resettable devices. See our online cross list at http://www.schurterinc.com/cross.htm</i>				
Series	PFMD	PFSM	PFRA	PFRX	PFST/PFLT
Page	106 -108	109 - 111	112 -115	116 -118	119 - 122
Mounting terminals	surface mount	surface mount	radial leaded	radial leaded	strap (standard or slotted)
Hold current I_H @ 23°C	200mA to 1.1A	300mA to 2.5A	100mA to 9A	1.1A to 3.75A	1A to 4.2A

Non-Resettable Surface Mount	 NEW EIA 1206	 With or without fuse clips			 NEW Time-lag version OMT	 New MSB / MKT Time lag versions
	Series / Voltage	MGA 125V	SFP 63V; SFC 63V	OMF 63V	OMF 125	OMF/OMT 125/250V
Page	127	128-129	130-131	132-133	134	135-136
Rated current	200mA to 5A	1A-5A; 800mA-4A	63mA to 10A	63mA to 10A	250mA to 4A	125mA to 7A
Time/current action	quick-acting	quick-acting	quick-acting	quick-acting	quick-acting or time-lag	quick-acting or time-lag

Through-Hole		 NEW Hermetically sealed		 NEW UL listed versions MSF-U & MST-U	 MXT with high breaking capacity	 NEW With radial leads
	Series / Voltage	MSA 125V	MGL 125V	MSF 125V	MSF 250V	MST/MXT 250V
Page	137	138	139	140	141/142	143
Rated current	63mA to 15A	200mA to 5A	100mA to 5A	40mA to 5A	50mA to 6.3A	250mA to 6.3A
Time/current action	quick-acting	quick-acting	quick-acting	quick-acting	time-lag	quick-acting or time-lag

5 x 20mm				
	<i>Quick-acting and time-lag characteristics available, with low, medium or high breaking capacities. Pigtail leads optional.</i>			
Series	SA/SP/SPT/FSM	FSF/FST/FTT/FSM	All series	Fuse kits for prototypes
Page	144 -154	144 - 154	144 - 154	156

Telecom Surge-Tolerant for Telecom applications						
	Series / Voltage	OSU 125V	OSU / OMT 250V	MSU 125V	MSU 250V	FRT 250V
Page	162	162	163	163	164	165-166
Rated current	250mA to 3.15A	250mA to 3.15A	250mA to 3.15A	250mA to 3.15A	250mA to 3.15A	250mA to 3.15A
Time/current action	quick-acting	quick-acting	quick-acting	quick-acting	quick-acting	quick-acting

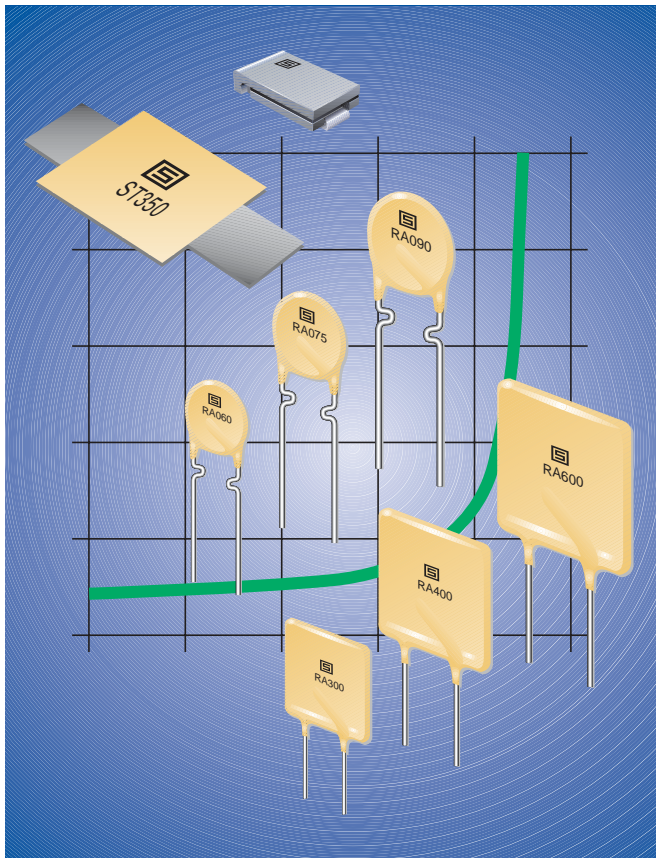

HOW POLYMERIC RESETTABLE OVERCURRENT PROTECTORS WORK

The conductive carbon black filler material in the polymeric device is dispersed in a polymer that has a crystalline structure. The crystalline structure densely packs the carbon particles into its crystalline boundary so they are close enough together to allow current to flow through the polymer insulator via these carbon “chains.”

When the conductive plastic material is at normal room temperature, there are numerous carbon chains forming conductive paths through the material.

Under fault conditions, excessive current flows through the polymeric device. I^2R heating causes the conductive plastic material’s temperature to rise. As this self heating continues, the material’s temperature continues to rise until it exceeds its phase transformation temperature. As the material passes through this phase transformation temperature, the densely packed crystalline polymer matrix changes to an amorphous structure. This phase change is accompanied by a small expansion. As the conductive particles move apart from each other, most of them no longer conduct current and the resistance of the device increases sharply.

The material will stay “hot,” remaining in this high resistance state as long as the power is applied. The device will remain latched, providing continuous protection, until the fault is cleared and the power is removed. Reversing the phase transformation allows the carbon chains to re-form as the polymer re-crystallizes. The resistance quickly returns to its original value.



RESETTABLE CIRCUIT PROTECTION

When it comes to Polymeric Positive Temperature Coefficient (PPTC) circuit protection, you now have a choice. If you need a reliable source, look to polymeric resettable fuses from SCHURTER.

Polymeric fuses are made from a conductive plastic formed into thin sheets, with electrodes attached to either side. The conductive plastic is manufactured from a non-conductive crystalline polymer and a highly conductive carbon black. The electrodes ensure even distribution of power through the device, and provide a surface for leads to be attached or for custom mounting.

The phenomenon that allows conductive plastic materials to be used for resettable overcurrent protection devices is that they exhibit a very large non-linear Positive Temperature Coefficient (PTC) effect when heated. PTC is a characteristic that many materials exhibit whereby resistance increases with temperature. What makes the polymeric conductive plastic material unique is the magnitude of its resistance increase. At a specific transition temperature, the increase in resistance is so great that it is typically expressed on a log scale.

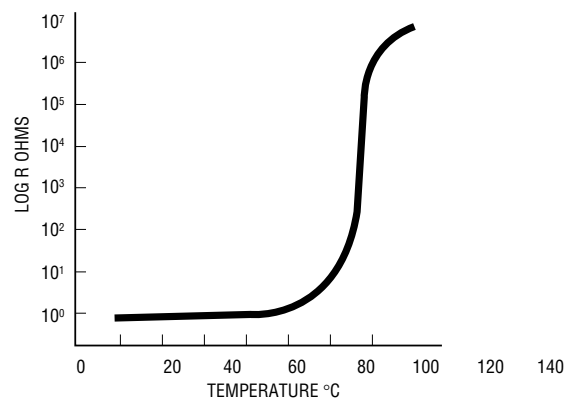

PRODUCT SELECTION

To select the correct polymeric circuit protection device, complete the information listed below for the application, and then refer to the resettable overcurrent protector data sheets.

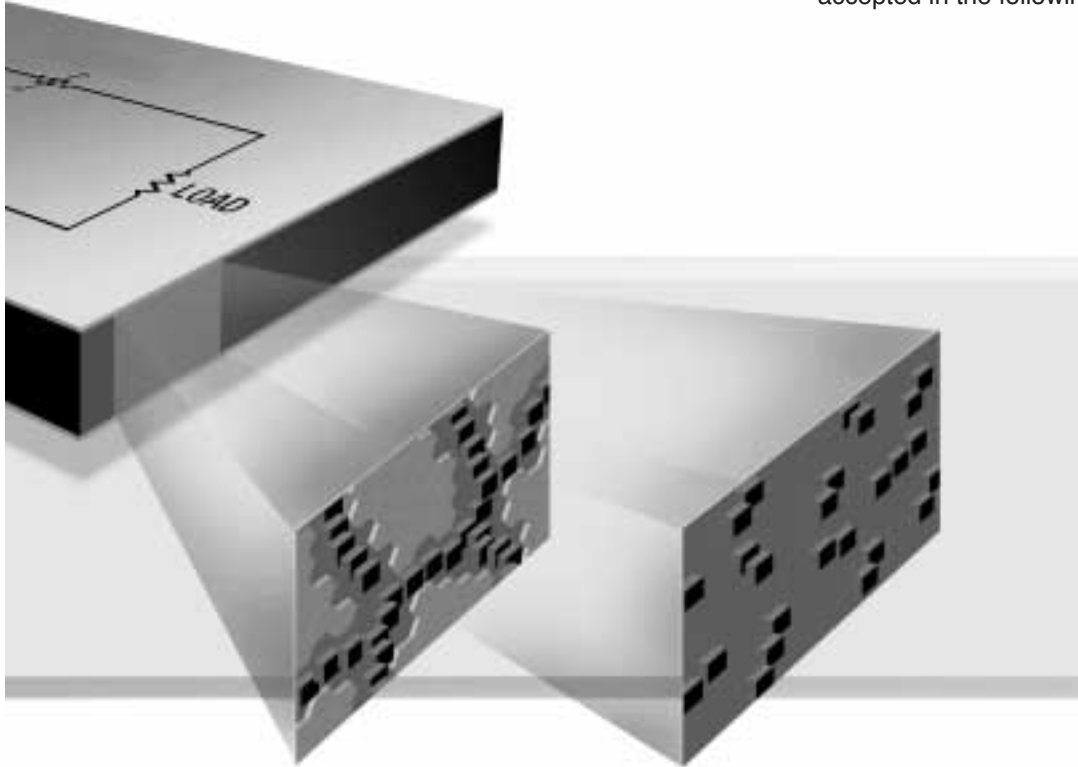

1. Determine the normal operating current:
_____ amps
2. Determine the maximum circuit voltage (V_{max}): _____ volts
3. Determine the fault current (I_{max}):
_____ amps
4. Determine the operating temperature range:
Minimum Temperature: _____ °C
Maximum Temperature: _____ °C
5. Select a product family so that the maximum rating for V_{max} and I_{max} is higher than the maximum circuit voltage and fault current in the application.
6. Using the I_{hold} vs. Temperature Table on the product family data sheet, select the polymeric device at the maximum operating temperature with an I_{hold} greater than or equal to the normal operating current.
7. Verify that the selected device will trip under fault conditions by checking in the I_{trip} table that the fault current is greater than I_{trip} for the selected device, at the lowest operating temperature.
8. Order samples and test in application.

APPLICATIONS

The benefits of polymeric Resettable Overcurrent Protectors are being recognized by more and more design engineers, and new applications are being discovered every day.

The use of polymeric types of devices have been widely accepted in the following applications and industries:

- Personal computers
- Laptop computers
- Personal digital assistants
- Transformers
- Small and medium electric motors
- Audio equipment and speakers
- Test and measurement equipment
- Security and fire alarm systems
- Medical electronics
- Personal care products
- Point-of-sale equipment
- Industrial controls
- Automotive electronics and harness protection
- Marine electronics
- Battery-operated toys

Schurter's resettable fuses cross to many like products already on the market. See our online cross list at www.schurterinc.com/cross.htm.

PFMD Polymeric PTC Resettable Fuse – Surface Mount



Typical Time to Trip at 23 °C

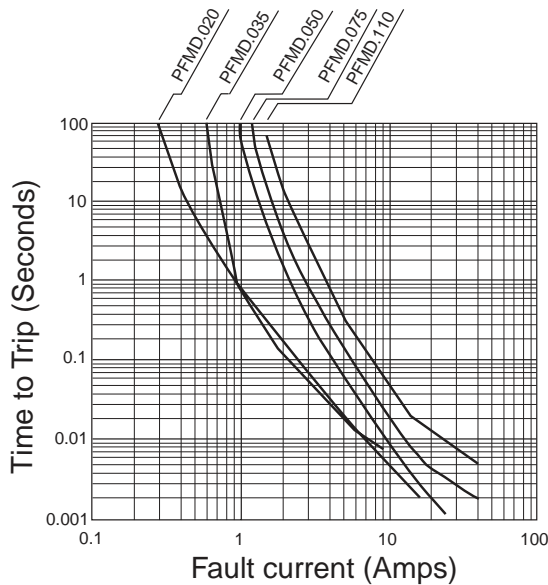

NEW



- High Density Circuit Board Application:
Hard disk drives,
PC motherboards
PC peripherals
Point-of-sale (POS) equipment
PCMCIA cards

- Packaged per EIA 481-2 standard

Approvals:

UL recognition
CSA pending
TÜV approval

Dimensions

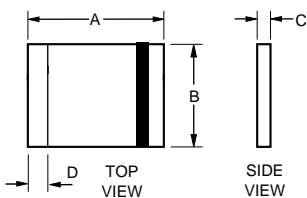

Dimensions in mm / (inch)

Solder Pad Layouts

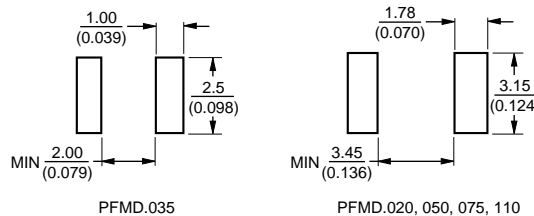

Typical Part Marking

Represents total content. Layout may vary.

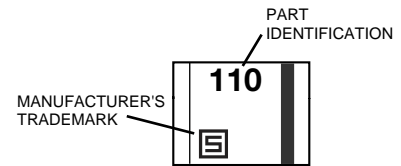

Technical Data

Operating/Storage Temperature	-40°C to +85°C	
Maximum Device Surface Temperature in Tripped State	125°C	
Passive Aging	+85°C, 1000 hours	±5% typical resistance change
Humidity Aging	+85°C, 85% R.H. 1000 hours	±5% typical resistance change
Thermal Shock	+125°C/-40°C 10 times	±10% typical resistance change
Mechanical Shock	MIL-STD-202, Method 213, Condition 1 (100g, 6 seconds)	No resistance change
Solvent Resistance	MIL-STD-202, Method 215	No change
Vibration	MIL-STD-883C, Method 2007.1, Condition A	No change
Terminal material	Solder-plated copper	
Termination pad solderability	Meets EIA Specification RS-186-9E, ANSI/J-STD-002 Cat.3	

Test Procedures And Requirements

Test	Test Conditions	Accept/Reject Criteria
Visual/Mech.	Verify dimensions and materials	Per PF physical description
Resistance	In still air @ 23°C	$R_{min} \leq R \leq R_{max}$
Time to Trip	At 8 Amps, V_{max} , 23°C	$T \leq \text{max. time to trip (seconds)}$
Hold Current	30 min. at I_{hold}	No trip
Trip Cycle Life	V_{max} , I_{max} , 100 cycles	No arcing or burning
Trip Endurance	V_{max} , 48 hours	No arcing or burning

Electrical Characteristics

Model	I max. Amps	V max. Volts	I _{hold}	I _{trip}	Initial Resistance		Max. Time To Trip at 23°C		Tripped Power Dissipation
			Amperes at 23°C		Ohms at 23°C		Amps	Seconds	Watts at 23°C
			Hold	Trip	R Min.	R1Max.			
PFMD.020.2	10	30.0	0.20	0.40	0.40	5.00	8.0	0.02	0.8
PFMD.035.2	40	6.0	0.35	0.70	0.32	1.30	8.0	0.10	0.6
PFMD.050.2	40	15.0	0.50	1.00	0.15	1.00	8.0	0.15	0.8
PFMD.075.2	40	13.2	0.75	1.50	0.11	0.45	8.0	0.20	0.8
PFMD.110.2	40	6.0	1.10	2.20	0.04	0.21	8.0	0.30	0.8

Product Dimensions

Model	A		B		C		D
	Min.	Max.	Min.	Max.	Min.	Max.	Min.
PFMD.020.2	4.37	4.73	3.07	3.41	0.56	0.81	0.30
PFMD.035.2	3.00	3.43	2.35	2.80	0.38	0.62	0.35
PFMD.050.2	4.37	4.73	3.07	3.41	0.38	0.62	0.30
PFMD.075.2	4.37	4.73	3.07	3.41	0.38	0.62	0.30
PFMD.110.2	4.37	4.73	3.07	3.41	0.38	0.62	0.30

How to Order

PFMD.020.2

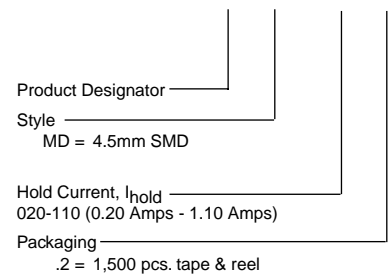

Solder Reflow And Rework Recommendations

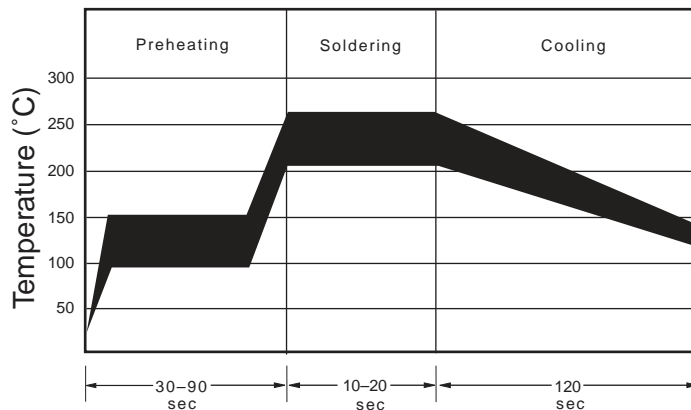

- Packaging options:
- TAPE & REEL: PFMD.035.2 = 3000 pcs per reel
All other models = 1500 pcs. per reel.

NOTE:

- PFMD models can be waved soldered and reworked.
- If reflow temperatures exceed the recommended profile, devices may not meet the performance requirements.

Thermal Derating Chart - I_{hold} (Amps)*

Part No.	Ambient Operating Temperature								
	-40°C	-20°C	0°C	23°C	40°C	50°C	60°C	70°C	85°C
PFMD.020.2	0.29 / 0.58	0.26 / 0.52	0.23 / 0.46	0.20 / 0.40	0.17 / 0.34	0.15 / 0.30	0.14 / 0.28	0.12 / 0.24	0.10 / 0.20
PFMD.035.2	0.47 / 0.94	0.45 / 0.90	0.40 / 0.80	0.35 / 0.70	0.30 / 0.60	0.28 / 0.56	0.24 / 0.48	0.21 / 0.42	0.18 / 0.36
PFMD.050.2	0.77 / 1.54	0.68 / 1.36	0.59 / 1.18	0.50 / 1.00	0.44 / 0.88	0.40 / 0.80	0.37 / 0.74	0.33 / 0.66	0.29 / 0.58
PFMD.075.2	1.15 / 2.30	1.01 / 2.02	0.88 / 1.76	0.75 / 1.50	0.65 / 1.30	0.60 / 1.20	0.55 / 1.10	0.49 / 0.98	0.43 / 0.86
PFMD.110.2	1.59 / 3.18	1.43 / 2.86	1.26 / 2.52	1.10 / 2.20	0.95 / 1.90	0.87 / 1.74	0.80 / 1.60	0.71 / 1.42	0.60 / 1.20

*I_{trip} = 2 • I_{hold}

Schurter's resettable fuses cross to many like products already on the market. See our online cross list at www.schurterinc.com/cross.htm

PFMD Tape and Reel Specifications



Tape Dimension Identifiers	PFMD 020, 050, 075, 110, per EIA-481-2	PFMD 035 per EIA 481-2
W	12 ± 0.3	8 ± 0.3
P ₀	4.0 ± 0.10	4.0 ± 0.10
P ₁	8.0 ± 0.10	4.0 ± 0.10
P ₂	2.0 ± 0.05	2.0 ± 0.05
A ₀	3.5 ± 0.23	2.8 ± 0.1
B ₀	5.1 ± 0.15	3.5 ± 0.1
B ₁ max.	5.9	4.35
D ₀	1.5 + 0.1/ - 0	1.5 + 0.1/ - 0
F	5.5 ± 0.05	3.5 ± 0.05
E ₁	1.75 ± 0.10	1.75 ± 0.10
E ₂ min.	10.25	6.25
T max.	0.6	0.6
T ₁ max.	0.1	0.1
K ₀	0.9 ± 0.15	1.1 ± 0.05
Leader min.	390	390
Trailer min.	160	160
Reel Dimension Identifiers		
A max.	185	185
N min.	50	50
W ₁	12.4 + 2.0/ - 0	8.4 + 1.5/ - 0
W ₂ max.	18.4	14.4

DIMENSIONS: MM

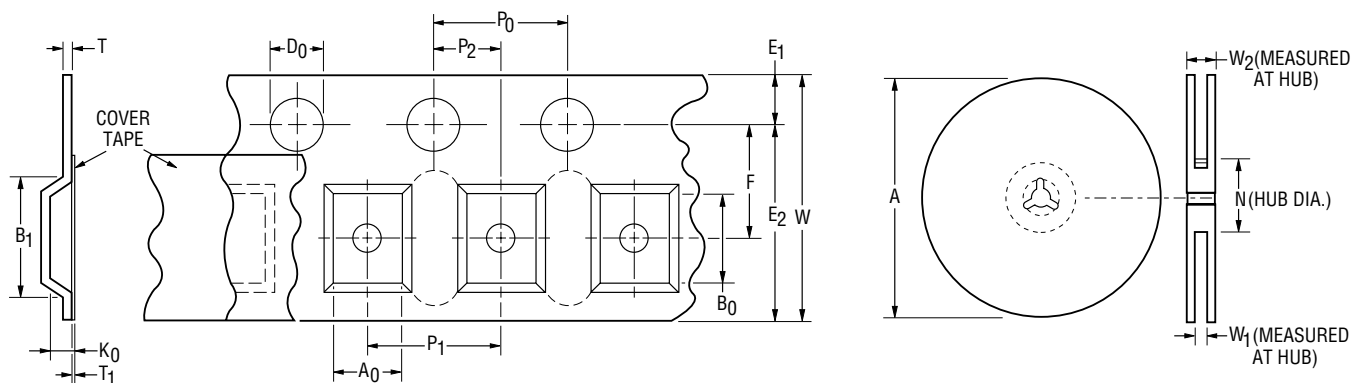

Specifications are subject to change without notice.

PFSM Polymeric PTC Resettable Fuse – Surface Mount



Typical Time to Trip at 23°C

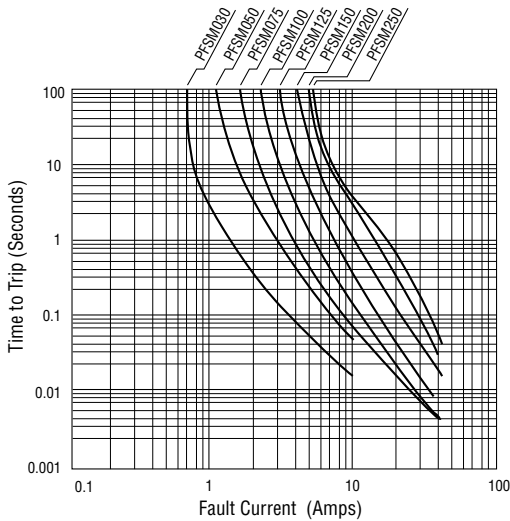

NEW



- Fully compatible with current industry standards
- Packaged per EIA 481-2 standard
- Applications: Almost anywhere there is a low voltage power supply and a load to be protected, including: computers & peripherals, general electronics, automotive applications

Approvals:

UL	recognition	File #E172175
CSA	acceptance	File #CA702083
TÜV	certification	File #R9872200

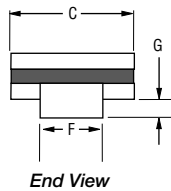
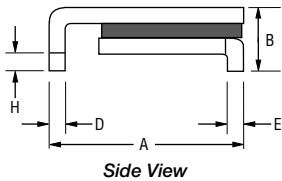

Typical Part Marking
Represents total content. Layout may vary.

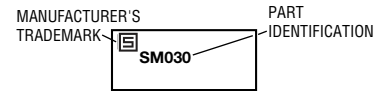

Recommended Pad Layout

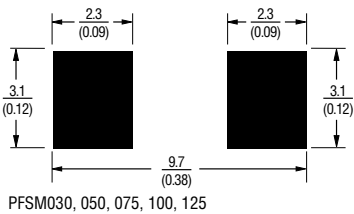

Recommended Pad Layout

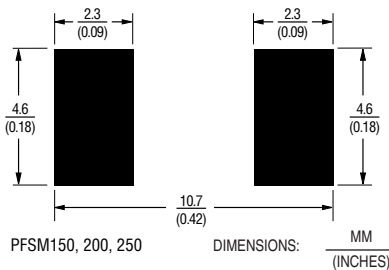

Technical Data

Operating/Storage Temperature	-40°C to +85°C	
Maximum Device Surface Temperature in Tripped State	125°C	
Passive Aging	+85°C, 1000 hours	±5% typical resistance change
Humidity Aging	+85°C, 85% R.H. 1000 hours	±5% typical resistance change
Thermal Shock	+125°C/-40°C 10 times	±10% typical resistance change
Mechanical Shock	MIL-STD-202, Method 213, Condition 1 (100g, 6 seconds)	No resistance change
Solvent Resistance	MIL-STD-202, Method 215	No change
Vibration	MIL-STD-883C, Method 2007.1, Condition A	No change

Test Procedures And Requirements

Test	Test Conditions	Accept/Reject Criteria
Visual/Mech.	Verify dimensions and materials	Per PF physical description
Resistance	In still air @ 23°C	Rmin ≤ R ≤ Rmax
Time to Trip	At specified current, Vmax, 23°C	T ≤ max. time to trip (seconds)
Hold Current	30 min. at Ihold	No trip
Trip Cycle Life	Vmax, Imax, 100 cycles	No arcing or burning
Trip Endurance	Vmax, 48 hours	No arcing or burning



Electrical Characteristics

Model	I max. Amps	V max. Volts	I _{hold}	I _{trip}	Initial Resistance		1 Hour (R1) Post-Reflow Resistance	Max. Time To Trip at 23°C		Tripped Power Dissipation
			Amperes at 23°C		Ohms at 23°C		Ohms at 23°C	Amps	Seconds	Watts at 23°C
			Hold	Trip	Min.	Max.	Max.		Max.	Nom.
PFSM030.2	10	60	0.30	0.60	0.90	-	4.80	1.5	3.0	1.7
PFSM050.2	10	30	0.50	1.00	0.35	-	1.40	2.5	4.0	1.7
PFSM075.2	40	30	0.75	1.50	0.27	-	1.00	8.0	0.30	1.7
PFSM100.2	40	15	1.10	2.20	0.12	-	0.48	8.0	0.50	1.7
PFSM125.2	40	15	1.25	2.50	0.07	-	0.25	8.0	2.0	1.7
PFSM150.2	40	15	1.50	3.00	0.06	-	0.25	8.0	5.0	1.9
PFSM200.2	40	15	2.00	4.00	0.05	-	0.125	8.0	12.0	1.9
PFSM250.2	40	15	2.50	5.00	0.035	-	0.085	8.0	25.0	1.9

Packaging options:

TAPE & REEL: PFSM.030 to PFSM.125 = 2000 pcs. per reel; PFSM.150 to PFSM.250 = 1500 pcs. per reel.

Product Dimensions

Model	A		B		C		D		E		F		G		H	
	Min.	Max.	Min.	Max.	Min.	Max.	Min.	Max.	Min.	Max.	Min.	Max.	Min.	Max.	Min.	Max.
PFSM030.2	6.73	7.98		3.18		5.44	0.56	0.71	0.56	0.71	2.16	2.41	0.66	1.37	0.43	
PFSM050.2	6.73	7.98		3.18		5.44	0.56	0.71	0.20	0.30	2.16	2.41	0.66	1.37	0.43	
PFSM075.2	6.73	7.98		3.18		5.44	0.56	0.71	0.56	0.71	2.16	2.41	0.66	1.37	0.43	
PFSM100.2	6.73	7.98		3.00		5.44	0.56	0.71	0.56	0.71	2.16	2.41	0.66	1.37	0.43	
PFSM125.2	6.73	7.98		3.00		5.44	0.56	0.71	0.56	0.71	2.16	2.41	0.66	1.37	0.43	
PFSM150.2	8.00	9.50		3.00		6.71	0.56	0.71	0.56	0.71	3.68	3.94	0.66	1.37	0.43	
PFSM200.2	8.00	9.50		3.00		6.71	0.56	0.71	0.56	0.71	3.68	3.94	0.66	1.37	0.43	
PFSM250.2	8.00	9.50		3.00		6.71	0.56	0.71	0.56	0.71	3.68	3.94	0.66	1.37	0.43	

DIMENSIONS = MM

Solder Reflow And Rework Recommendations

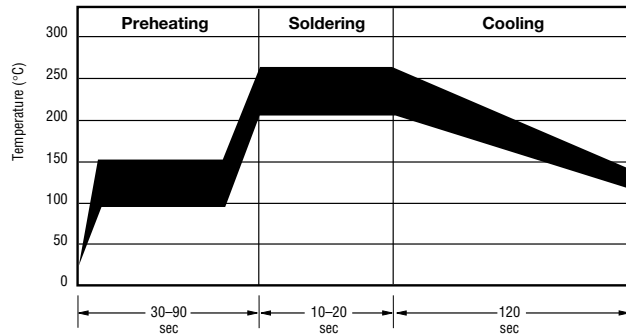

Solder reflow

- Recommended reflow methods: IR, vapor phase oven, hot air oven.
- Devices are not designed to be wave soldered to the bottom side of the board.
- Gluing the devices is not recommended.
- Recommended maximum paste thickness is 0.25 mm (.010 inch).
- Devices can be cleaned using standard industry methods and solvents.

Note: If reflow temperatures exceed the recommended profile, devices may not meet the performance requirements

Rework

- A device should not be reworked.

Thermal Derating Chart - I_{hold} (Amps)*

Model	Ambient Operating Temperature								
	-40°C	-20°C	0°C	23°C	40°C	50°C	60°C	70°C	85°C
PFSM030.2	0.45	0.40	0.35	0.30	0.25	0.23	0.20	0.17	0.14
PFSM050.2	0.76	0.67	0.59	0.50	0.42	0.38	0.33	0.29	0.23
PFSM075.2	1.13	1.01	0.88	0.75	0.62	0.56	0.50	0.44	0.34
PFSM100.2	1.66	1.47	1.29	1.10	0.91	0.83	0.73	0.64	0.50
PFSM125.2	1.89	1.68	1.46	1.25	1.04	0.94	0.83	0.73	0.56
PFSM150.2	2.27	2.01	1.76	1.50	1.25	1.13	0.99	0.87	0.68
PFSM200.2	3.02	2.68	2.34	2.00	1.66	1.50	1.32	1.16	0.90
PFSM250.2	3.78	3.35	2.93	2.50	2.08	1.88	1.65	1.45	1.13

*I_{trip} = 2 • I_{hold}

How To Order

Product Designator **PF SM . 030 . 2**

Style _____

SM = Surface Mount Component

Hold Current, I_{hold} _____
030-250 (0.30 Amps - 2.50 Amps)

Packaging Options _____
Packaged per EIA 481-2
.2 = Tape and Reel

Schurter's resettable fuses cross to many like products already on the market. See our online cross list at www.schurterinc.com/cross.htm

PFSM Tape and Reel Specifications



Tape Dimension Identifiers	PFSM 030, 050, 075, 100, 125 per EIA-481-2	PFSM 150, 200, 250 per EIA 481-2
W	16 ± 0.3	16 ± 0.3
P ₀	4.0 ± 0.10	4.0 ± 0.10
P ₁	8.0 ± 0.10	12.0 ± 0.10
P ₂	2.0 ± 0.10	2.0 ± 0.10
A ₀	5.7 ± 0.10	6.9 ± 0.10
B ₀	8.1 ± 0.15	10.0 ± 0.10
B ₁ max.	9.1	11.0
D ₀	1.5 + 0.1/ - 0	1.5 + 0.1/ - 0
F	7.5 ± 0.10	7.5 ± 0.10
E ₁	1.75 ± 0.10	1.75 ± 0.10
E ₂ min.	14.25	14.25
T max.	0.4	0.4
T ₁ max.	0.1	0.1
K ₀	3.4 ± 0.15	3.5 ± 0.10
Leader min.	390	390
Trailer min.	160	160
Reel Dimension Identifiers		
A max.	360	360
N min.	50	50
W ₁	16.4 + 2.0/ - 0	16.4 + 2.0/ - 0
W ₂ max.	22.4	22.4

DIMENSIONS:

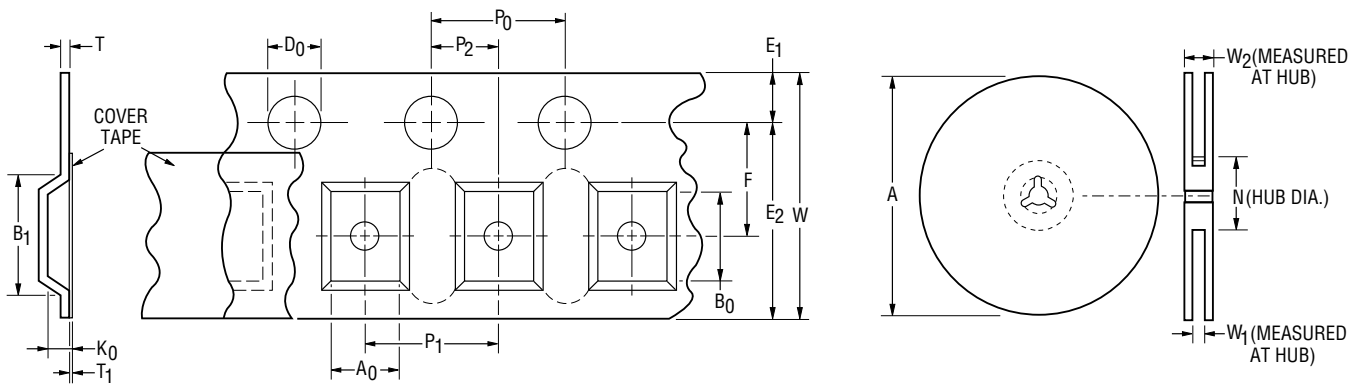

Specifications are subject to change without notice.

PFRA Polymeric PTC Resettable Fuse - Radial Leaded



Typical Time to Trip at 23°C

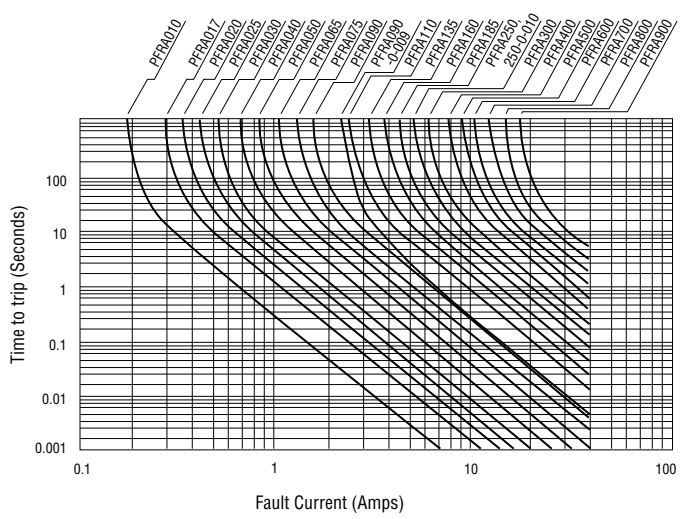

NEW

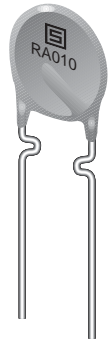

- Cured, flame retardant epoxy polymer insulating material meets UL 94V-0 requirements
- Bulk packaging, tape and reel and Ammo-Pak available on most models
- Applications: Almost anywhere there is a low voltage power supply and a load to be protected, including: computers & peripherals, general electronics, automotive applications

Approvals*

- UL recognition, file #E172175
.1A - 9A/30V (.1A-9A/60V pending)
- CSA acceptance, file #CA702083
[.1A - .9A/60V; .9A(.009) to 9A/30V]
- TÜV certification, file #R9872200
[.1A - .9A/60V; .9A(.009) to 9A/30V]

* rated amps at hold current I_{hold}

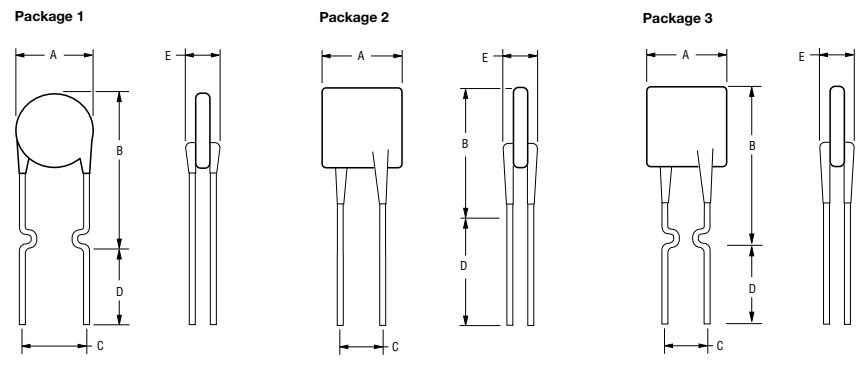

NOTE: Kinked lead option is available for board standoff. Contact factory for details.
Shape changes from round to square starting with PFRA.250.

Typical Part Marking
Represents total content. Layout may vary.

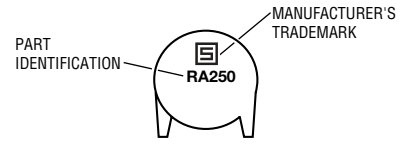

Technical Data

Operating/Storage Temperature	-40°C to +85°C	
Maximum Device Surface Temperature in Tripped State	125°C	
Passive Aging	+85°C, 1000 hours	±5% typical resistance change
Humidity Aging	+85°C, 85% R.H. 1000 hours	±5% typical resistance change
Thermal Shock	+125°C/-40°C 10 times	±10% typical resistance change
Mechanical Shock	MIL-STD-202, Method 213, Condition 1 (100g, 6 seconds)	No resistance change
Solvent Resistance	MIL-STD-202, Method 215	No change
Vibration	MIL-STD-883C, Method 2007.1, Condition A	No change

Test Procedures And Requirements

Test	Test Conditions	Accept/Reject Criteria
Visual/Mech.	Verify dimensions and materials	Per PF physical description
Resistance	In still air @ 23°C	R _{min} ≤ R ≤ R _{max}
Time to Trip	5 times I _{hold} , V _{max} , 23°C	T ≤ max. time to trip (seconds)
Hold Current	30 min. at I _{hold}	No trip
Trip Cycle Life	V _{max} , I _{max} , 100 cycles	No arcing or burning
Trip Endurance	V _{max} , 48 hours	No arcing or burning
UL File Number	See above	
CSA File Number	See above	
TÜV File Number	See above	

Specifications are subject to change without notice.

PFRA Technical Data, continued



Electrical Characteristics

Model	V max. Volts	I max. Amps	Ihold	Itrip	Initial Resistance		1 Hour (R ₁) Post-Trip Resistance	Max. Time To Trip at 5*1h	Tripped Power Dissipation
			Amperes at 23°C		Ohms at 23°C		Ohms at 23°C	Seconds at 23°C	Watts at 23°C
			Hold	Trip	Min.	Max.	Max.		
PFRA.010.X	60	40	0.10	0.20	2.50	4.50	7.50	4.0	0.38
PFRA.017.X	60	40	0.17	0.34	2.00	3.20	8.00	3.0	0.48
PFRA.020.X	60	40	0.20	0.40	1.50	2.84	4.40	2.2	0.40
PFRA.025.X	60	40	0.25	0.50	1.00	1.95	3.00	2.5	0.45
PFRA.030.X	60	40	0.30	0.60	0.76	1.36	2.10	3.0	0.50
PFRA.040.X	60	40	0.40	0.80	0.52	0.86	1.29	3.8	0.55
PFRA.050.X	60	40	0.50	1.00	0.41	0.77	1.17	4.0	0.75
PFRA.065.X	60	40	0.65	1.30	0.27	0.48	0.72	5.3	0.90
PFRA.075.X	60	40	0.75	1.50	0.18	0.40	0.60	6.3	0.90
PFRA.090.X	60	40	0.90	1.80	0.14	0.31	0.47	7.2	1.00
PFRA.090.X.009	30	40	0.90	1.80	0.07	0.12	0.22	5.9	0.60
PFRA.110.X	30	40	1.10	2.20	0.10	0.18	0.27	6.6	0.70
PFRA.135.X	30	40	1.35	2.70	0.065	0.115	0.17	7.3	0.80
PFRA.160.X	30	40	1.60	3.20	0.055	0.105	0.15	8.0	0.90
PFRA.185.X	30	40	1.85	3.70	0.04	0.07	0.11	8.7	1.00
PFRA.250.X	30	40	2.50	5.00	0.025	0.048	0.07	10.3	1.20
PFRA.250.X.010	30	40	2.50	5.00	0.025	0.048	0.07	10.3	1.20
PFRA.300.X	30	40	3.00	6.00	0.02	0.05	0.08	10.8	2.00
PFRA.400.X	30	40	4.00	8.00	0.01	0.03	0.05	12.7	2.50
PFRA.500	30	40	5.00	10.00	0.01	0.03	0.05	14.5	3.00
PFRA.600	30	40	6.00	12.00	0.005	0.02	0.04	16.0	3.50
PFRA.700	30	40	7.00	14.00	0.005	0.02	0.03	17.5	3.80
PFRA.800	30	40	8.00	16.00	0.005	0.02	0.03	18.8	4.00
PFRA.900	30	40	9.00	18.00	0.005	0.01	0.02	*20.0	4.20

*Tested at 40 amps

Packaging options

BULK: PFRA.010-PFRA.185 = 500 pcs. per bag; PFRA.250-PFRA.900 = 100 pcs. per bag;
(leave.X space) PFRA.090.X.009 & PFRA.250.X.010 = 500 pcs. per bag.

TAPE & REEL: PFRA.010-PFRA.160 - 12.7mm device pitch = 3000 pcs. per reel;
X=.2 PFRA.185-PFRA.400 - 25.4mm device pitch = 1500 pcs. per reel;
PFRA.090.X.009 & PFR.A250.X.010 = 3000 pcs. per reel.

AMMO-PACK: PFRA.010-PFRA.160 - 12.7mm device pitch = 2000 pcs. per reel;
X=.3 PFRA.185-PFRA.400 - 25.4mm device pitch = 1000 pcs. per reel;
PFRA.090.X.009 & PFRA.250.X.010 = 2000 pcs. per reel.

Product Dimension

Model	A Max.	B Max.	C		D Min.	E Max.	Physical Characteristics		
			Nom.	Tol. ±			Style	Lead	Material
PFRA.010.X	7.4	12.7	5.1	0.7	7.6	3.1	1	0.51 dia.	Sn/NiCu
PFRA.017.X	7.4	12.7	5.1	0.7	7.6	3.1	1	0.51 dia.	Sn/CuFe
PFRA.020.X	7.4	12.7	5.1	0.7	7.6	3.1	1	0.51 dia.	Sn/CuFe
PFRA.025.X	7.4	12.7	5.1	0.7	7.6	3.1	1	0.51 dia.	Sn/CuFe
PFRA.030.X	7.4	13.4	5.1	0.7	7.6	3.1	1	0.51 dia.	Sn/CuFe
PFRA.040.X	7.4	13.7	5.1	0.7	7.6	3.1	1	0.51 dia.	Sn/CuFe
PFRA.050.X	7.9	13.7	5.1	0.7	7.6	3.1	1	0.51 dia.	Sn/Cu
PFRA.065.X	9.7	15.2	5.1	0.7	7.6	3.1	1	0.51 dia.	Sn/Cu
PFRA.075.X	10.4	16.0	5.1	0.7	7.6	3.1	1	0.51 dia.	Sn/Cu
PFRA.090.X	11.7	16.7	5.1	0.7	7.6	3.1	1	0.51 dia.	Sn/Cu
PFRA.090.X.009	7.4	12.2	5.1	0.7	7.6	3.0	2	0.51 dia.	Sn/Cu
PFRA.110.X	8.9	14.0	5.1	0.7	7.6	3.0	1	0.51 dia.	Sn/Cu
PFRA.135.X	8.9	18.9	5.1	0.7	7.6	3.0	1	0.51 dia.	Sn/Cu
PFRA.160.X	10.2	16.8	5.1	0.7	7.6	3.0	1	0.51 dia.	Sn/Cu
PFRA.185.X	12.0	18.4	5.1	0.7	7.6	3.0	1	0.51 dia.	Sn/Cu
PFRA.250.X	12.0	18.3	5.1	0.7	7.6	3.0	2	0.81 dia.	Sn/Cu
PFRA.250.X.010	11.4	18.3	5.1	0.7	7.6	3.0	3	0.51 dia.	Sn/Cu
PFRA.300.X	12.0	18.3	5.1	0.7	7.6	3.0	2	0.81 dia.	Sn/Cu
PFRA.400.X	14.4	24.8	5.1	0.7	7.6	3.0	2	0.81 dia.	Sn/Cu
PFRA.500	17.4	24.9	10.2	0.7	7.6	3.0	2	0.81 dia.	Sn/Cu
PFRA.600	19.3	31.9	10.2	0.7	7.6	3.0	2	0.81 dia.	Sn/Cu
PFRA.700	22.1	29.8	10.2	0.7	7.6	3.0	2	0.81 dia.	Sn/Cu
PFRA.800	24.2	32.9	10.2	0.7	7.6	3.0	2	0.81 dia.	Sn/Cu
PFRA.900	24.2	32.9	10.2	0.7	7.6	3.0	2	0.81 dia.	Sn/Cu

Dimension = mm

Thermal Derating Chart - I_{hold} (Amps)*

Model	Ambient Operating Temperature								
	-40°C	-20°C	0°C	23°C	40°C	50°C	60°C	70°C	85°C
PFRA.010.X	0.16	0.14	0.12	0.10	0.08	0.07	0.06	0.05	0.04
PFRA.017.X	0.26	0.23	0.20	0.17	0.14	0.12	0.11	0.09	0.07
PFRA.020.X	0.31	0.27	0.24	0.20	0.16	0.14	0.13	0.11	0.08
PFRA.025.X	0.39	0.34	0.30	0.25	0.20	0.18	0.16	0.14	0.10
PFRA.030.X	0.47	0.41	0.36	0.30	0.24	0.22	0.19	0.16	0.12
PFRA.040.X	0.62	0.54	0.48	0.40	0.32	0.29	0.25	0.22	0.16
PFRA.050.X	0.78	0.68	0.60	0.50	0.41	0.36	0.32	0.27	0.20
PFRA.065.X	1.01	0.88	0.77	0.65	0.53	0.47	0.41	0.35	0.26
PFRA.075.X	1.16	1.02	0.89	0.75	0.61	0.54	0.47	0.41	0.30
PFRA.090.X	1.40	1.22	1.07	0.90	0.73	0.65	0.57	0.49	0.36
PFRA.090.X.009	1.40	1.22	1.07	0.90	0.73	0.65	0.57	0.49	0.36
PFRA.110.X	1.60	1.43	1.27	1.10	0.91	0.85	0.75	0.67	0.57
PFRA.135.X	1.96	1.76	1.55	1.35	1.12	1.04	0.92	0.82	0.70
PFRA.160.X	2.32	2.08	1.84	1.60	1.33	1.23	1.09	0.98	0.83
PFRA.185.X	2.68	2.41	2.13	1.85	1.54	1.42	1.26	1.13	0.96
PFRA.250.X	3.63	3.25	2.88	2.50	2.08	1.93	1.70	1.53	1.30
PFRA.250.X.010	3.63	3.25	2.88	2.50	2.08	1.93	1.70	1.53	1.30
PFRA.300.X	4.35	3.90	3.45	3.00	2.49	2.31	2.04	1.83	1.56
PFRA.400.X	5.80	5.20	4.60	4.00	3.32	3.08	2.72	2.44	2.08
PFRA.500	7.25	6.50	5.75	5.00	4.15	3.85	3.40	3.05	2.60
PFRA.600	8.70	7.80	6.90	6.00	4.98	4.62	4.08	3.66	3.12
PFRA.700	10.15	9.10	8.05	7.00	5.81	5.39	4.76	4.27	3.64
PFRA.800	11.60	10.40	9.20	8.00	6.64	6.16	5.44	4.88	4.16
PFRA.900	13.05	11.70	10.35	9.00	7.47	6.39	6.12	5.49	4.68

See the following page for tape and reel specifications.

$$*I_{trip} = 2 \cdot I_{hold}$$

How to Order

PF RA . 250 . X

Product Designator ┌

Style _____

RA = Radial Leaded Component

Hold Current, I_{hold} _____

010-900 (100m Amps - 9.0 Amps)

Packaging Options _____

Blank = Bulk Packaging
 .2 = Tape and Reel*
 .3 = Ammo-Pak*

NOTE: Add designator "010" after Packaging Option
 Code to specify Models PFRA090-0-010 or
 PFRA250-0-010.

*Packaged per EIA486-B

Schurter's resettable fuses cross to many like products already on the market.

See our online cross list at www.schurterinc.com/cross.htm

PFRA Tape and Reel Specifications



Devices taped using EIA468-B/IEC286-2 standards. See table below and Figures 1 and 2 for details.

Dimension Description	IEC Mark	EIA Mark	Dimensions	
			Dim. (mm)	Tol. (mm)
Carrier tape width	<i>W</i>	<i>W</i>	18	-0.5/+1.0
Hold down tape width		<i>W4</i>	5	min.
Hold down tape	<i>W0</i>		No protrusion	
Top distance between tape edges	<i>W2</i>	<i>W6</i>	3	max.
Sprocket hole position	<i>W1</i>	<i>W5</i>	9	-0.5/+0.75
Sprocket hole diameter	<i>D0</i>	<i>D0</i>	4	± 0.2
Abscissa to plane (straight lead)	<i>H</i>	<i>H</i>	18.5	± 3.0
Abscissa to plane (kinked lead)	<i>H0</i>	<i>H0</i>	16	± 0.5
Abscissa to top	<i>H1</i>	<i>H1</i>	32.2	max.
Overall width w/lead protrusion		<i>C1</i>	43.2	max.
Overall width w/o lead protrusion		<i>C2</i>	42.5	max.
Lead protrusion	<i>I1</i>	<i>L1</i>	1.0	max.
Protrusion of cutout	<i>L</i>	<i>L</i>	11	max.
Protrusion beyond hold tape	<i>I2</i>	<i>I2</i>	Not specified	
Sprocket hole pitch	<i>P0</i>	<i>P0</i>	12.7	± 0.3
Pitch tolerance			20 seconds	± 1
Device pitch: PFRA.010 – PFRA.160			12.7	
Device pitch: PFRA.185 – PFRA.400			25.4	
Tape thickness	<i>t</i>	<i>t</i>	0.9	max.
Tape thickness with splice		<i>t1</i>	2.0	max.
Splice sprocket hole alignment			0	± 0.3
Body lateral deviation	Δh	Δh	0	± 1.0
Body tape plane deviation	Δp	Δp	0	± 1.3
Lead seating plane deviation	$\Delta P1$	<i>P1</i>	0	± 0.7
Lead spacing	<i>F</i>	<i>F</i>	5.08	± 0.8
Reel width	<i>w</i>	<i>w</i>	56	max.
Reel diameter	<i>d</i>	<i>a</i>	370	max.
Space between flanges less device			4.75	± 3.25
Arbor hole diameter	<i>f</i>	<i>c</i>	26	± 12.0
Core diameter	<i>h</i>	<i>n</i>	80	max.
Box			56/372/372	max.
Consecutive missing places			3 maximum	
Empty places per reel			Not specified	

Taped Component Dimensions

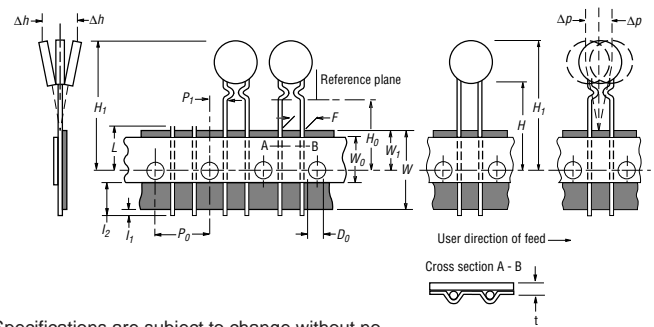

Reel Dimensions

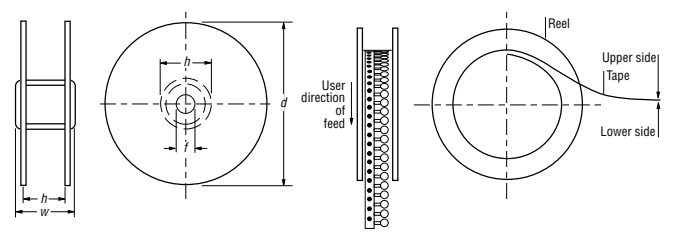

Specifications are subject to change without notice.

PFRX Polymeric PTC Resettable Fuse - Radial Leaded



Typical Time to Trip at 23°C

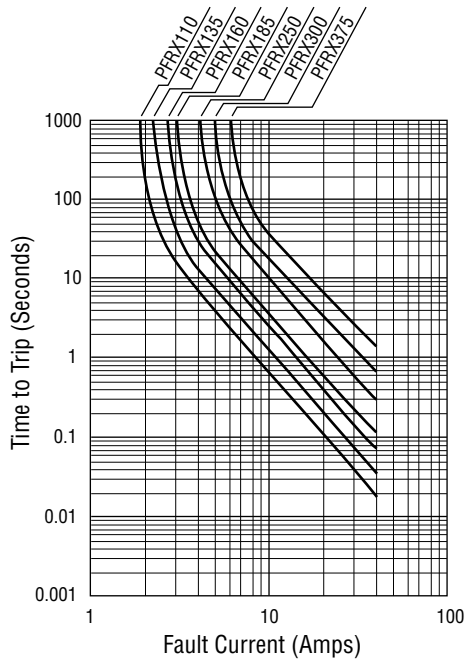

NEW



- Cured, flame retardant epoxy polymer insulating material meets UL 94V-0 requirements
- Bulk packaging, tape and reel and Ammo-Pak available on most models
- Applications: Almost anywhere there is a low voltage power supply, up to 60V and a load to be protected, including: computers & peripherals, general electronics, automotive applications

Approvals:

- UL recognition, file #E172175 (60V)
- CSA acceptance, file #CA702083 (60V)
- TÜV certification, file #R9872200 (60V)

Package 1

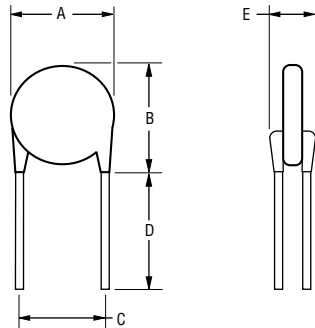

Lead Material
0.81 dia. (20AWG)

NOTE: Kinked lead option is available for board standoff. Contact factory for details.

Typical Part Marking

Represents total content. Layout may vary.

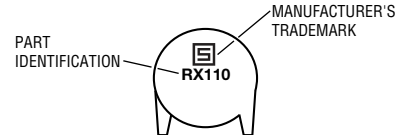

Technical Data

Operating/Storage Temperature	-40°C to +85°C	
Maximum Device Surface Temperature in Tripped State	125°C	
Passive Aging	+85°C, 1000 hours	±5% typical resistance change
Humidity Aging	+85°C, 85% R.H. 1000 hours	±5% typical resistance change
Thermal Shock	+125°C/-40°C 10 times	±10% typical resistance change
Mechanical Shock	MIL-STD-202, Method 213, Condition 1 (100g, 6 seconds)	No resistance change
Solvent Resistance	MIL-STD-202, Method 215	No change
Vibration	MIL-STD-883C, Method 2007.1, Condition A	No change

Test Procedures And Requirements

Test	Test Conditions	Accept/Reject Criteria
Visual/Mech.	Verify dimensions and materials	Per PF physical description
Resistance	In still air @ 23°C	$R_{min} \leq R \leq R_{max}$
Time to Trip	5 times Ihold, Vmax, 23°C	T ≤ max. time to trip (seconds)
Hold Current	30 min. at Ihold	No trip
Trip Cycle Life	Vmax, Imax, 100 cycles	No arcing or burning
Trip Endurance	Vmax, 48 hours	No arcing or burning

PFRX Technical Data, continued



Electrical Characteristics

Model	V max. Volts	I max. Amps	I _{hold}	I _{trip}	Initial Resistance		1 Hour (R ₁) Post-Trip Resistance	Max. Time To Trip at 5*I _h	Tripped Power Dissipation
			Amperes at 23°C		Ohms at 23°C		Ohms at 23°C	Seconds at 23°C	Watts at 23°C
			Hold	Trip	Min.	Max.	Max.		
PFRX.110.X	60	40	1.10	2.20	0.15	0.25	0.38	8.2	1.50
PFRX.135.X	60	40	1.35	2.70	0.12	0.19	0.30	9.6	1.70
PFRX.160.X	60	40	1.60	3.20	0.09	0.14	0.22	11.4	1.90
PFRX.185.X	60	40	1.85	3.70	0.08	0.12	0.19	12.6	2.10
PFRX.250	60	40	2.50	5.00	0.05	0.08	0.13	15.6	2.50
PFRX.300	60	40	3.00	6.00	0.04	0.06	0.10	19.8	2.80
PFRX.375	60	40	3.75	7.50	0.03	0.05	0.08	24.0	3.20

Packaging options:

BULK: All models = 100 pcs. per bag.
(leave .X space empty)

TAPE & REEL: PFRX.110 – PFRX.160 = 1500 pcs. per reel; PFRX.185 = 1000 pcs. per reel
.X = 2

AMMO-PACK: PFRX.110 – PFRX.160 = 1000 pcs. per reel; PFRX.185 = 500 pcs. per reel
.X = 3

Product Dimensions

Model	A	B	C		D	E	Physical Characteristics		
	Max.	Max.	Nom.	Tol. ±	Min.	Max.	Style	Lead	Material
PFRX.110.X	13.0	18.0	5.1	0.7	7.6	3.1	1	0.81 dia.	Sn/Cu
PFRX.135.X	14.5	19.6	5.1	0.7	7.6	3.1	1	0.81 dia.	Sn/Cu
PFRX.160.X	16.3	21.3	5.1	0.7	7.6	3.1	1	0.81 dia.	Sn/Cu
PFRX.185.X	17.8	22.9	5.1	0.7	7.6	3.1	1	0.81 dia.	Sn/Cu
PFRX.250	21.3	26.4	10.2	0.7	7.6	3.1	1	0.81 dia.	Sn/Cu
PFRX.300	24.9	30.0	10.2	0.7	7.6	3.1	1	0.81 dia.	Sn/Cu
PFRX.375	28.4	33.5	10.2	0.7	7.6	3.1	1	0.81 dia.	Sn/Cu

DIMENSIONS = MM

Thermal Derating Chart - I_{hold} (Amps)

Part No.	Ambient Operating Temperature								
	-40°C	-20°C	0°C	23°C	40°C	50°C	60°C	70°C	85°C
PFRX.110.X	1.71	1.50	1.31	1.10	0.89	0.79	0.69	0.59	0.44
PFRX.135.X	2.09	1.84	1.61	1.35	1.09	0.97	0.85	0.73	0.54
PFRX.160.X	2.48	2.18	1.90	1.60	1.30	1.15	1.01	0.86	0.64
PFRX.185.X	2.87	2.52	2.20	1.85	1.50	1.33	1.17	1.00	0.74
PFRX.250	3.88	3.40	2.98	2.50	2.03	1.80	1.58	1.35	1.00
PFRX.300	4.65	4.08	3.57	3.00	2.43	2.16	1.89	1.62	1.20
PFRX.375	5.81	5.10	4.46	3.75	3.04	2.70	2.36	2.03	1.50

How to Order

Product Designator **PF RX . 110 . X**

Style _____

RX = Radial Leaded Component

Hold Current, I_{hold} _____
110-375 (1.10 Amps - 3.75 Amps)

blank = Bulk Packaging
.2 = Tape and Reel*
.3 = Ammo-Pak*

*Packaged per EIA 486-B

Schurter's resettable fuses cross to many like products already on the market. [See our online cross list at www.schurterinc.com/cross.htm](http://www.schurterinc.com/cross.htm)

PFRX Tape and Reel Specifications



Devices taped using EIA468-B/IEC286-2 standards. See table below and Figures 1 and 2 for details.

Dimension Description	IEC Mark	EIA Mark	Dimensions	
			Dim. (mm)	Tol. (mm)
Carrier tape width	<i>W</i>	<i>W</i>	18	-0.5/+1.0
Hold down tape width		<i>W4</i>	5	min.
Hold down tape	<i>W0</i>		No protrusion	
Top distance between tape edges	<i>W2</i>	<i>W6</i>	3	max.
Sprocket hole position	<i>W1</i>	<i>W5</i>	9	-0.5/+0.75
Sprocket hole diameter	<i>D0</i>	<i>D0</i>	4	± 0.2
Abscissa to plane (straight lead)	<i>H</i>	<i>H</i>	18.5	± 3.0
Abscissa to plane (kinked lead)	<i>H0</i>	<i>H0</i>	16	± 0.5
Abscissa to top	<i>H1</i>	<i>H1</i>	32.2	max.
Overall width w/lead protrusion		<i>C1</i>	43.2	max.
Overall width w/o lead protrusion		<i>C2</i>	42.5	max.
Lead protrusion	<i>I1</i>	<i>L1</i>	1.0	max.
Protrusion of cutout	<i>L</i>	<i>L</i>	11	max.
Protrusion beyond hold tape	<i>I2</i>	<i>I2</i>	Not specified	
Sprocket hole pitch	<i>P0</i>	<i>P0</i>	12.7	± 0.3
Pitch tolerance			20 seconds	± 1
Device pitch: PFRX.110 – PFRX.160			12.7	
Device pitch: PFRX.185 – PFRX.375			25.4	
Tape thickness	<i>t</i>	<i>t</i>	0.9	max.
Tape thickness with splice		<i>t1</i>	2.0	max.
Splice sprocket hole alignment			0	± 0.3
Body lateral deviation	Δh	Δh	0	± 1.0
Body tape plane deviation	Δp	Δp	0	± 1.3
Lead seating plane deviation	$\Delta P1$	<i>P1</i>	0	± 0.7
Lead spacing	<i>F</i>	<i>F</i>	5.08	± 0.8
Reel width	<i>w</i>	<i>w</i>	56	max.
Reel diameter	<i>d</i>	<i>a</i>	370	max.
Space between flanges less device			4.75	± 3.25
Arbor hole diameter	<i>f</i>	<i>c</i>	26	± 12.0
Core diameter	<i>h</i>	<i>n</i>	80	max.
Box			56/372/372	max.
Consecutive missing places			3 maximum	
Empty places per reel			Not specified	

Taped Component Dimensions

Reel Dimensions

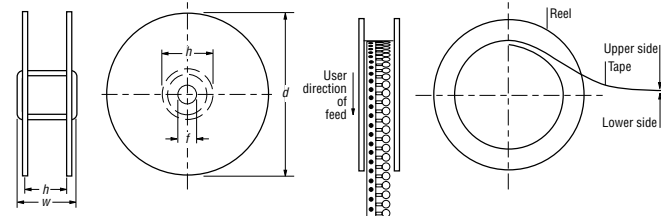
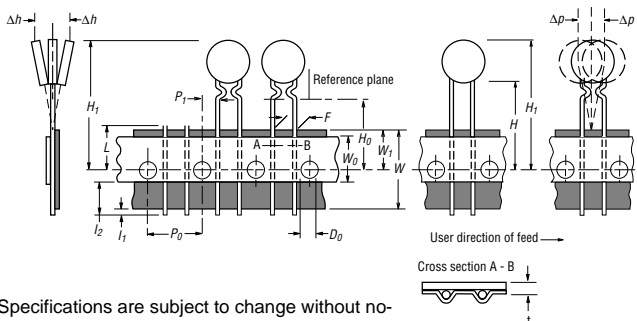

Specifications are subject to change without notice.

PFST Polymeric PTC Resettable Fuse - Strap



Typical Time to Trip at 23°C

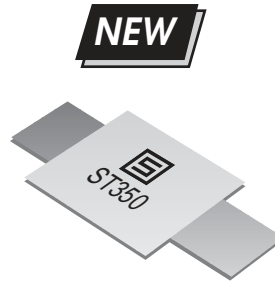
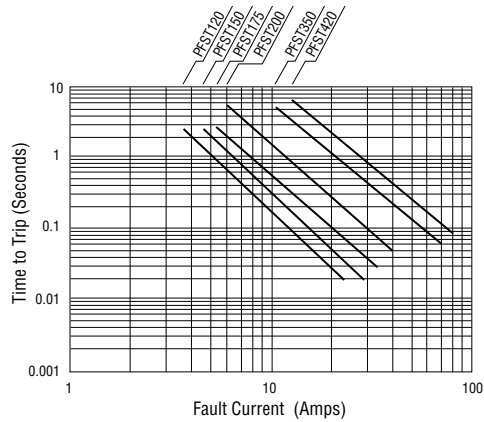

- Fully compatible with current industry standards
- Weldable nickel terminals
- Very low internal resistance
- Applications: Rechargeable Battery Pack Protection

Approvals*:

- UL recognition, file #E172175 (1.2A - 1.75A/15V; 2A - 3.5A/30V)
- CSA acceptance, file #CA702083 (1.2A - 1.75A/15V; 2A - 4.2A/30V)
- TÜV certification, file #R9872200

* rated amps at hold current I_{hold}

Standard Package

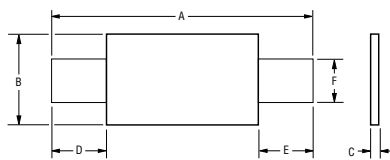

"S" Package

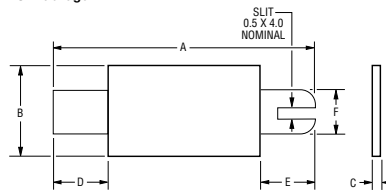

Typical Part Marking

Represents total content. Layout may vary.

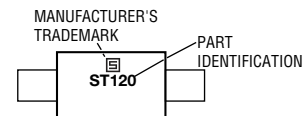

Technical Data

Operating/Storage Temperature	-40°C to +85°C	
Maximum Device Surface Temperature in Tripped State	125°C	
Passive Aging	+85°C, 1000 hours	±5% typical resistance change
Humidity Aging	+85°C, 85% R.H. 1000 hours	±5% typical resistance change
Thermal Shock	+125°C/-40°C 10 times	±10% typical resistance change
Vibration	MIL-STD-883C, Method 2007.1, Condition A	No change

Test Procedures And Requirements

Test	Test Conditions	Accept/Reject Criteria
Visual/Mech.	Verify dimensions and materials	Per PF physical description
Resistance	In still air @ 23°C	$R_{min} \leq R \leq R_{ma}$
Time to Trip	At specified current, max. 23°C	$T \leq \text{max. time to trip (seconds)}$
Hold Current	30 min. at I_{hold}	No trip
Trip Cycle Life	V_{max} , I_{max} , 100 cycles	No arcing or burning
Trip Endurance	V_{max} , 48 hours	No arcing or burning

Product Dimensions

Model	A		B		C		D		F		Material
	Min.	Max.	Min.	Max.	Min.	Max.	Min.	Max.	Min.	Max.	
PFST.120	19.9	22.1	4.9	5.2	0.6	1.0	5.5	7.5	3.9	4.1	Nickel
PFST.120S	19.9	22.1	4.9	5.2	0.6	1.0	5.5	7.5	3.9	4.1	Nickel
PFST.150	21.3	23.4	10.2	11.0	0.5	1.1	4.1	5.5	4.8	5.4	Nickel
PFST.175	20.9	23.1	4.9	5.2	0.6	1.0	4.1	5.5	3.9	4.1	Nickel
PFST.175S	20.9	23.1	4.9	5.2	0.6	1.0	4.1	5.5	3.9	4.1	Nickel
PFST.200	21.3	23.4	10.2	11.0	0.5	1.1	5.0	7.6	4.8	5.4	Nickel
PFST.350	28.4	31.8	13.0	13.5	0.5	1.1	6.3	8.9	6.0	6.6	Nickel
PFST.420	30.6	32.4	12.9	13.6	0.5	1.1	5.0	7.5	6.0	6.7	Nickel

DIMENSIONS = MM

PFST Technical Data, continued



Electrical Characteristics

Model	V max. Volts	I max. Amps	I _{hold}	I _{trip}	Initial Resistance		1 Hour (R ₁) Post-Trip Resistance	Max. Time To Trip at 5*I _h	Tripped Power Dissipation
			Amperes at 23°C		Ohms at 23°C		Ohms at 23°C	Seconds at 23°C	Watts at 23°C
			Hold	Trip	Min.	Max.	Max.		
PFST.120	15	100	1.20	2.7	0.085	0.160	0.22	5.0	1.2
PFST.120S	15	100	1.20	2.7	0.085	0.160	0.22	5.0	1.2
PFST.150	15	100	1.50	3.00	0.05	0.09	0.11	5.0	1.30
PFST.175	15	100	1.75	3.8	0.05	0.09	0.120	4.0	1.5
PFST.175S	15	100	1.75	3.8	0.05	0.09	0.120	4.0	1.5
PFST.200	30	100	2.00	4.4	0.03	0.06	0.080	4.0	1.90
PFST.350	30	100	3.50	6.3	0.017	0.031	0.040	3.0*	2.50
PFST.420	30	100	4.20	7.6	0.012	0.024	0.040	6.0*	2.90

All models packaged loose.

*Tested at 20.0 Amps

Optional slotted leads (.S) available for 1.20 A and 1.75 A ratings

Thermal Derating Chart - I_{hold} (Amps)

Model	Ambient Operating Temperature								
	-40°C	-20°C	0°C	23°C	40°C	50°C	60°C	70°C	85°C
PFST.120	1.9	1.7	1.5	1.2	1.0	0.9	0.8	0.7	0.5
PFST.120S	1.9	1.7	1.5	1.2	1.0	0.9	0.8	0.7	0.5
PFST.150	2.2	2.0	1.8	1.5	1.3	1.1	1.0	0.9	0.7
PFST.175	2.5	2.3	2.0	1.7	1.5	1.3	1.2	1.1	0.9
PFST.175S	2.5	2.3	2.0	1.7	1.5	1.3	1.2	1.1	0.9
PFST.200	3.2	2.8	2.5	2.0	1.7	1.6	1.4	1.2	0.9
PFST.350	5.4	4.8	4.3	3.5	3.0	2.8	2.5	2.2	1.7
PFST.420	6.4	5.7	5.1	4.2	3.6	3.3	3.0	2.6	2.1

How To Order

PF ST.120 .S

Product

Designator

Style

ST = Axial Leaded "Strap" Component

Hold Current, I_{hold}

120-420 (1.20 Amps - 4.20 Amps)

Slotted Lead Option

(.120S and .175S only)

Schurter's resettable fuses cross to many like products already on the market.

See our online cross list at www.schurterinc.com/cross.htm

PFLT Polymeric PTC Resettable Fuse - Axial Leaded



Typical Time to Trip at 23°C

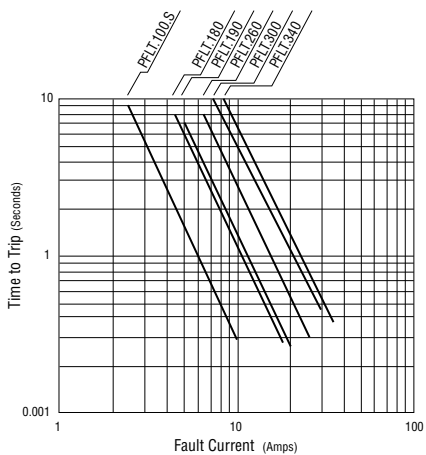

NEW

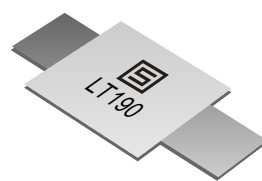

- Fully compatible with current industry standards
- Weldable nickel terminals
- Very low internal resistance
- Applications: Any application that requires extra protection at elevated ambient temperatures, which the 100°C trip temperature provides, including rechargeable battery pack protection, cellular phones, laptop computers

Approvals:

UL recognition, file #E172175
 CSA acceptance, file #CA702083
 TÜV certification, file #R9872200

PFLT models offer trip temperatures lower than PFST models for extra protection at elevated temperatures.

Standard Package

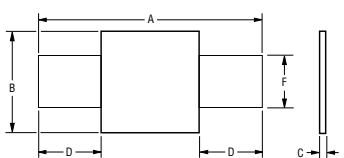

"S" Package

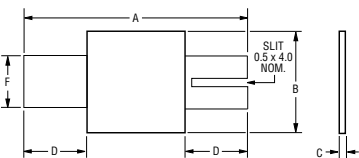

Typical Part Marking
 Represents total content. Layout may vary.

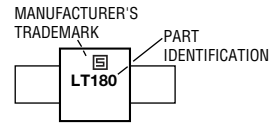

Technical Data

Operating/Storage Temperature	-40°C to +85°C	
Maximum Device Surface Temperature in Tripped State	125°C	
Passive Aging	+85°C, 1000 hours	±5% typical resistance change
Humidity Aging	+85°C, 85% R.H. 1000 hours	±5% typical resistance change
Thermal Shock	+125°C/-40°C 10 times	±10% typical resistance change
Vibration	MIL-STD-883C, Method 2007.1, Condition A	

Test Procedures And Requirements

Test	Test Conditions	Accept/Reject Criteria
Visual/Mech.	Verify dimensions and materials	Per PF physical description
Resistance	In still air @ 23°C	$R_{min} \leq R \leq R_{max}$
Time to Trip	At specified current, 23°C	$T \leq \text{max. time to trip (seconds)}$
Hold Current	30 min. at Ihold	No trip
Trip Cycle Life	Vmax, Imax, 100 cycles	No arcing or burning
Trip Endurance	Vmax, 48 hours	No arcing or burning

Product Dimensions

Model	A		B		C		D		F		Package Style
	Min.	Max.	Min.	Max.	Min.	Max.	Min.	Max.	Min.	Max.	
PFLT.100.S	20.9	23.1	4.9	5.2	0.6	1.0	4.1	5.5	3.9	4.1	S
PFLT.180	24.0	26.0	4.9	5.2	0.6	1.0	4.1	5.5	3.9	4.1	Std.
PFLT.180.S	24.0	26.0	4.9	5.2	0.6	1.0	4.1	5.5	3.9	4.1	S
PFLT.190	21.3	23.4	10.2	11.0	0.5	1.1	5.0	7.6	4.8	5.4	Std.
PFLT.260	24.0	26.0	10.8	11.9	0.6	1.0	5.0	7.0	5.9	6.1	Std.
PFLT.300	28.4	31.8	13.0	13.5	0.5	1.1	6.3	8.9	6.0	6.6	Std.
PFLT.340	24.0	26.0	14.8	15.9	0.6	1.0	4.0	5.0	5.9	6.1	Std.

DIMENSIONS = MM

Electrical Characteristics

Model	V max. Volts	I max. Amps	I_{hold}	I_{trip}	Initial Resistance		1 Hour (R_1) Post-Trip Resistance	Max. Time To Trip at $5 \cdot I_h$	Tripped Power Dissipation
			Amperes at 23°C		Ohms at 23°C		Ohms at 23°C	Seconds at 23°C	Watts at 23°C
			Hold	Trip	Min.	Max.	Max.		
PFLT.100.S	24	100	1.0	2.5	0.070	0.130	0.260	7.0	1.5
PFLT.180	24	100	1.8	3.8	0.040	0.068	0.120	2.9	2.0
PFLT.180.S	24	100	1.8	3.8	0.040	0.068	0.120	2.9	2.0
PFLT.190	24	100	1.9	4.2	0.030	0.057	0.100	3.0	1.9
PFLT.260	24	100	2.6	5.2	0.025	0.042	0.076	5.0	2.3
PFLT.300	24	100	3.0	6.3	0.015	0.031	0.055	4.0	2.0
PFLT.340	24	100	3.4	6.8	0.016	0.027	0.050	5.0	2.7

All models packaged loose. Optional slotted leads (.S) available for 1A and 1.8A ratings.

 Thermal Derating Chart - I_{hold} (Amps)

Model	Ambient Operating Temperature								
	-40°C	-20°C	0°C	23°C	40°C	50°C	60°C	70°C	85°C
PFLT.100.S	1.8	1.6	1.4	1.0	0.8	0.7	0.6	0.4	0.2
PFLT.180	3.1	2.6	2.2	1.8	1.3	1.1	0.9	0.6	0.2
PFLT.180.S	3.1	2.6	2.2	1.8	1.3	1.1	0.9	0.6	0.2
PFLT.190	3.3	2.8	2.4	1.9	1.4	1.2	1.1	0.7	0.4
PFLT.260	4.3	3.7	3.1	2.6	1.9	1.6	1.4	1.1	0.6
PFLT.300	5.1	4.4	3.7	3.0	2.3	1.9	1.6	1.2	0.6
PFLT.340	5.5	4.7	4.0	3.4	2.6	2.2	1.9	1.5	0.8

How To Order

PF LT . 100 . S

Product Designator _____
 Style _____
 LT = Low Temperature Axial Leaded "Strap" Component
 Hold Current, I_{hold} _____
 100-340 (1.00 Amps - 3.40 Amps)
 Slotted Lead Option _____
 (100.s and 180.s only)

Schurter's resettable fuses cross to many like products already on the market.

See our online cross list at www.schurterinc.com/cross.htm

About Non-Resettable Fuses

How to Specify Fuses:

The safety of electronic and electric equipment not only depends upon the use of shock-safe primary circuit components (fuseholders, voltage selector switches, power entry modules, etc.) designed primarily for the protection of service personnel, but also on devices protecting the safe operation of the equipment itself. Since in many cases fuses are the only means of providing circuit protection in the event of overloads or fault conditions, we suggest the following considerations be observed when fuses are being selected.

1. Fuse Standards

There are three principal standards a fuse can be designed to:
 1) UL 248-14 2) CSA 22.2 No. 59 3) IEC 127

Please note that these standards may not necessarily be compatible with each other. The main difference between the various standards are as follows:

- different blowing characteristics between UL/CSA and IEC standards
- different temperature rise requirements between UL and CSA standards

The incompatibility of these standards makes it impossible to use one and the same fuse across the world in a given application. Attention needs to be given to the fact that the governing Standard in Europe is IEC. Observation of this fact in the early design stage will save trouble and confusion during the agency approval process. Note: new fuse qualifications have been established for low-voltage fuses; reference EIA/IS-722.

2. Approval Agencies

National approval agencies which approve miniature type fuses conforming to either UL, CSA, or IEC standards are: UL (USA), CSA (Canada), VDE (Germany), SEMKO (Sweden), BSI (United

Kingdom). It is important to understand that UL and CSA not only write standards but also issue conformance approvals. IEC, however, limits itself to writing the standards. Conformance with these IEC standards is tested by VDE, SEMKO, and BSI.

A UL approved fuse will either bear the listing or the recognized mark. A listed fuse meets all the requirements of fuse Standard UL 248-14. A fuse with the recognition mark is tested under the Component Program of UL to the fuse manufacturer's own specifications.

CSA now has an equivalent to the Recognized Component Program of UL: CSA Component Acceptance . As far as fuse size is concerned, UL and CSA accept a wide range of dimensions (including the 5 x 20mm size, notably with UL/CSA blowing characteristics!) IEC has standardized around the 5 x 20mm size (notably with IEC blowing characteristics!). The only other size in IEC's document is the 1/4 x 1 1/4" fuse (only in quick acting, low breaking capacity configuration).

Because of overlapping dimensions between the various standards, caution has to be used when trying to categorize or identify a 5 x 20mm or 1/4 x 1 1/4" fuses. The chart below summarizes the aforementioned.

IMPORTANT: All CENELEC (European Committee for Electronic Standards) countries, including EC and EFTA nations, require a high-breaking capacity fuse-link, if the short circuit current through the fuse-link is more than 35A or 10 x I_n, whichever is greater, effective January 1st, 1993. Please refer to **Series SP (pg. 145)** and **SPT (pg. 148)**.

3. Rated Current

The rated current of the fuse should be in accordance with the operating current of the equipment to be protected. Consideration

Fuse Standards and Approvals Around The World

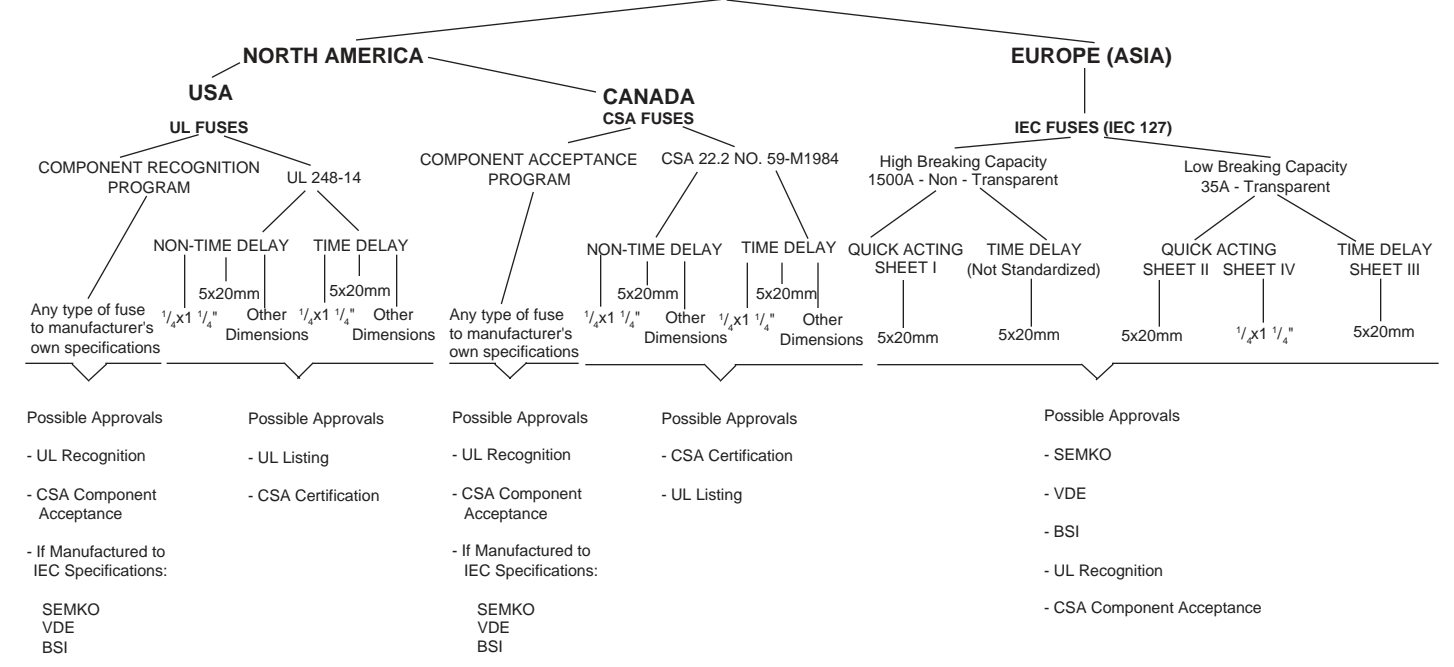

About Non-Resettable Fuses, continued

needs to be given to the fact that the current carrying capacity of a fuse is affected by changes in ambient temperature. IEC and UL/CSA tests are performed at 23°C and 25°C respectively. In practical applications the fuse's ambient temperature may be significantly higher, especially if the fuse is used in an enclosed type fuseholder or mounted near other heat generating components. The effect of changes in the ambient temperature is shown in the chart below.

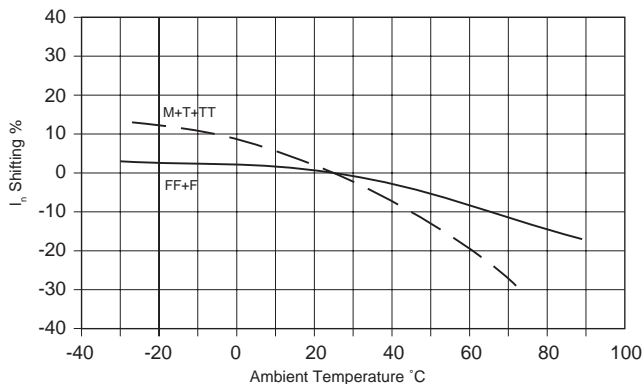

In addition to the effect of ambient temperature conditions, it is recommended to also de-rate UL listed fuses by approximately 25% of the original current ratios. This is, however, not required for IEC fuses (See Para. 10).

4. Rated Voltage

The rated voltage of the fuse should be in no case lower than the operating voltage. At low operating voltage, the inherent resistance must be considered.

Please note that UL and CSA require the use of 250V rated fuses in Power Entry Modules.

5. Breaking Capacity/Short Circuit Rating

The breaking capacity is the short-circuit current which the fuse can break at the rated voltage under the advanced conditions without being destroyed or causing permanent arcing.

Under IEC, miniature type fuses are classified into two categories:

Fuses with Low Breaking Capacity

Typically, the fuse-element of a fuse with low breaking capacity is visible. The insulation tube consists of transparent material, normally glass. There is no extinguishing medium, the arc is quenched in air. The breaking capacity at 250 V and a power factor of 1 is 35 A.

Fuses with High Breaking Capacity

The fuse-element of a fuse with high breaking capacity is not visible. The insulation tube normally is of ceramic material or glass. To quench the arc, there is always an extinguishing medium. The breaking capacity at 250 V and a power factor of .7 to .8 is 1500 A.

UL's and CSA's short circuit requirements are similar, but different as relates to IEC. At 125 V a UL listed fuse has to interrupt 10,000 Amps AC, whereas at 250 V the range may vary from 35 Amps up to 1500 Amps depending on the specific current rating of the fuse.

6. Breaking Characteristic

The breaking characteristic is shown in the respective time-current blowing charts for each fuse type. The breaking characteristic is the melting time of a fuse given a defined load. The melting time is a function of the fuse wire length and diameter as well as its base material and alloy.

IEC fuses are classified as follows:

Quick-Acting Fuses

Application: Protection of semiconductors and for very sensitive instruments. This fuse type tolerates small overcurrents for a short period of time but breaks very quickly at higher current values. It limits short circuit currents at a very early stage.

Time-Lag Fuses

Application: Protection of devices subjected to moderate to high in-rush currents and/or overcurrent peaks, such as transformers and motors. This type of fuse also tolerates higher overcurrents during a short period of time.

UL/CSA fuses are divided into:

Non Time Delay Fuses

These fuses are sometimes also referred to as Normal Blow types.

Time Delay Fuses

These fuses are sometimes also referred to as Slow Blow or Surge Proof types.

For certain applications neither of the above described types may prove usable. Since the writing of Standards by IEC/UL/CSA does not always keep pace with the latest technological advances various fuse manufacturers have developed fuses outside the realm of such standards.

Generally the agencies allow the use of such fuses if a particular application dictates it. The OEM's risks are that it has to rely on manufacturer's own specifications that are not routinely checked by a safety agency. Schurter offers the following use types for such purposes:

Super Quick-Acting Fuses

Application: Protection of semiconductors at the base of S1 and GE (thyristors, triacs, diodes). This fuse type tolerates small overcurrents only during a short period of time and limits the current at small short-circuit currents.

Medium Time-Lag Fuses

Applications: Protection devices subjected to moderate to high in-rush currents and/or overcurrent peaks, such as transformers and motors. This fuse type also tolerates higher overcurrents during a short period of time. Due to its conformance with DIN Standard 41571, this fuse is widely used in Germany; mainly in government related applications.

Super Time-Lag Fuses

Application: Protection of devices subjected to longer lasting in-rush currents and/or high overcurrent peaks like transformers and motors. This type tolerates higher overcurrents during a longer period of time.

About Non-Resettable Fuses, continued

7. Blowing Charts and Tables

This catalog differentiates between two types of blowing charts and tables: IEC and UL/CSA. Proper understanding of these differences is essential when one tries to match the fuse characteristics to the circuit requirements.

a) Chart and Table for IEC fuses: This chart is an interval graph showing a curve representing the minimum blowing times and another curve representing maximum values for a set of current ratings. The tables give the checkpoints or "gates" mandated by IEC. Please note that only the gate values are tested by the agencies. Values on the curve between two gates are geometrically arrived at and are not guaranteed by the manufacturer.

b) Chart and Table for UL/CSA listed fuses: The curves for this graph represent average values, individually for each current rating.

8. Fusing Integral I²t

The fusing integral is the thermal energy needed to melt the fuse-element. The fusing integral I²t is used to determine:

- the blowing time for higher overcurrents
- the aging behavior of a fuse caused by in-rush currents.

The formula given below is only valid for blowing periods of less than 10 ms.

$$t = \frac{I^2t}{(\text{overcurrent})^2} = \text{seconds} + 20\%$$

To prevent aging caused by in-rush currents we recommend staying within the following limits:

I ² t of in-rush (to be determined by user)	less than 30% of fuse I ² t for time delay fuses
	less than 40% of fuse I ² t for normal blow fuses

The proper selection of a fuse requires that attention be given to this subject. Often times a fuse problem can only be pinpointed after a thorough study of this issue.

9. Power Dissipation

Power dissipation heats up the fuse and its surroundings. Especially when selecting fuseholders, it is important to ensure that, allowing for the ambient temperature, they are capable of absorbing sufficient dissipated power. Please refer to the power dissipation sections on the individual fuse pages when selecting a fuse.

10. Specification of Characteristics

To quickly and easily classify the various fuse types by their time-current characteristics, the following letter codes are stamped on IEC, or other 5 x 20mm fuses.

	=	Letter Code
super quick-acting	=	FF
quick-acting	=	F
medium time-lag	=	M

time-lag	=	T
super time-lag	=	TT

Example of fuse markings: T200 mA / 250 V

UL listed and CSA certified fuses are not as easily identifiable because neither any lettering nor color code is required on the fuse itself.

11. Dimensions

Traditionally the dimensions have been 5 x 20mm for international type fuses and 1/4 x 1 1/4" (6.3 x 32mm) for domestic, Northern American fuses. Today however, IEC 5 x 20mm fuses with UL recognition and CSA Component Acceptance are becoming increasingly popular in North America, especially in applications where saving space is a major concern.

It should also be pointed out that the 5 x 20mm fuse is available at most over-the-counter distributors as well as radio supply shops in North America.

IEC fuses of the 1/4 x 1 1/4" size should not be used in North America. These fuses were designed for replacement use in American made equipment located in Europe.

12. Interchangeability of IEC Fuses with UL Fuses and Vice Versa

For general applications the rated current of the fuse to be converted should be multiplied/divided by a factor 2 depending on whether the fuse has to be converted from the use in a 250V circuit to the use in a 125V circuit or vice versa. In this case, however, the fuse normally doesn't provide anything more than short current protection. For a more accurate correlation, the time current characteristic curves of both the IEC and UL fuse must be compared. As a rule of thumb, a factor of 2.4 to 2.6 can be used to convert an IEC fuse (used in a 250V circuit) into a UL fuse (used in a 125V circuit) with the corresponding characteristics (e.g. a 1 A IEC fuse corresponds to a 2.5 A UL fuse).

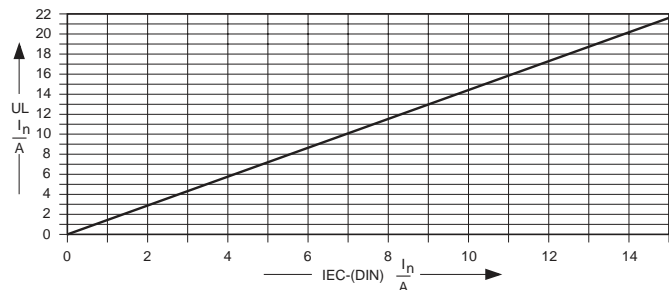

13. Quality Control

Details about Schurter's strict quality control procedures are available upon request.

Should you need fuses for non-standard applications, please contact our Engineering Department.

Note: new fuse qualifications have been established for low-voltage fuses; reference EIA/IS-722.

MGA 125V 125V Quick-acting Surface Mount Fuse

Built according to EIASOCM-3216 (equivalent to 1206), meets EIA/IS-722 fuse qualification standard.

Approvals:

UL recognition 200mA-3A¹⁾ File #E153466
 CSA acceptance 200mA-3A¹⁾ File #LR51172
¹⁾ 4A-5A approvals pending

NEW

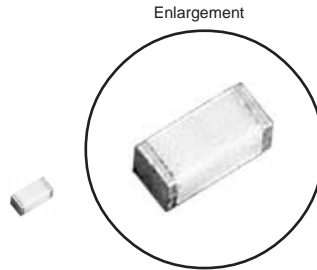
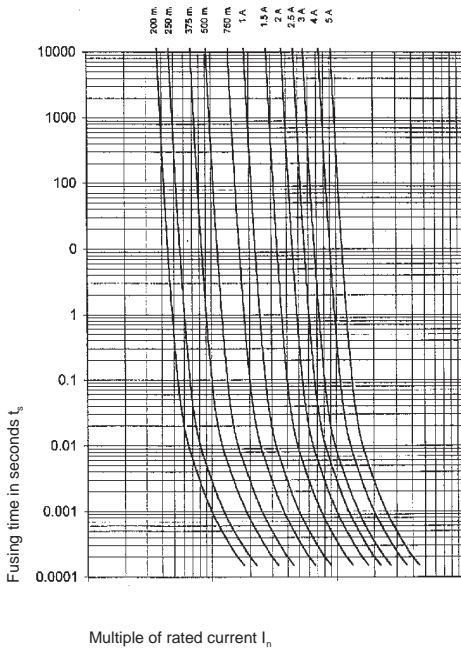

- "Flip chip" design mounts on any side
- Lowest resistance
- Quick-acting
- Hermetically sealed for operating temperatures in excess of 150°C
- Low energy let-through
- Superior cycling

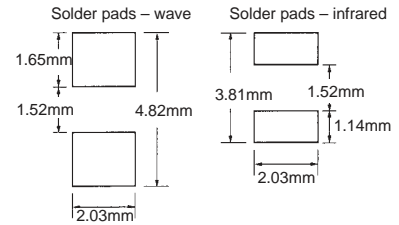
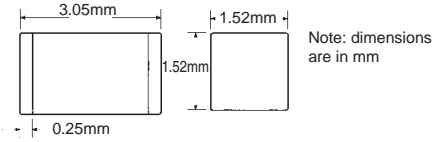

Reel diameter: 179mm (750 pieces & 3,000 pieces)

Time Current Characteristics

rated current I_n	$n \cdot I_n$	I_n	$2.5 \cdot I_n$
	200mA – 5A	≥ 4 h	≤ 5 s

Technical Data

Rated current	see chart
Time current characteristic	quick-acting
Interrupt capacity	50 A AC, 300A DC
Ambient temperature max.	+150°C
Climatic category	hermetically sealed
Solderability	reflow: 260°C / 30 sec. max; wave: 260°C / 10 sec. max.
Soldering heat resistance	60 seconds above 200°C, max. 260°C
Material: Housing	ceramic
Terminals	nickel, tin-lead coated
Packaging	8mm tape and reel per EIA-RS481 (equivalent to IEC 286-3)

Order Numbers – Standard	Rated current / voltage mA / A / V ~	Breaking capacity A ~ ac / dc	Voltage drop at I_n typical mV	Resistance at 10% I_n Ohms	Fusing Integral typ. A ² s	Packaging Order No. Suffix
3410.0021.XX	200 mA / 125V	50 A ac / 300A dc	212	0.870	0.0013	100 pieces taped & bagged: .XX = .01
3410.0022.XX*	250 mA / 125V		176	0.632	0.0027	
3410.0025.XX	375 mA / 125V		140	0.320	0.0039	
3410.0027.XX	500 mA / 125V		126	0.198	0.0066	
3410.0029.XX	750 mA / 125V		118	0.113	0.015	
3410.0031.XX	1 A / 125V		135	0.096	0.0042	750 pieces taped & reeled: .XX = .02
3410.0033.XX	1.5 A / 125V		123	0.056	0.12	
3410.0035.XX	2 A / 125V		117	0.039	0.20	
3410.0036.XX	2.5 A / 125V		115	0.0295	0.35	10,000 pieces taped & reeled: .XX = .04
3410.0037.XX	3 A / 125V		112	0.0235	0.55	
3410.0140.XX	4 A / 32V†	110	0.0163	0.85		
3410.0141.XX	5 A / 32V†	108	0.0125	1.0		

All ratings measured at 125V, ambient temperature 25°C +/-3°C

* meets UL 1459/1950
 † 4A/63V = 3410.0240.XX
 6A/63V = 3410.0241.XX

MGA Tape and Reel Specifications

Tape Dimension Identifiers	MGA per EIA 481-1
W	8 ± 0.3
P_0	4.0 ± 0.10
P_1	4.0 ± 0.10
P_2	2.0 ± 0.05
A_0	1.91 ± 0.1
B_0	3.56 ± 0.1
B_1 max.	4.35
D_0	$1.5 + 0.1/ -0$
F	3.5 ± 0.05
E_1	1.75 ± 0.10
E_2 min.	6.25
T max.	0.6
T_1 max.	0.1
K_0	1.65 ± 0.1
Leader min.	390
Trailer min.	160
Reel Dimension Identifiers	
A max.	330
N min.	50
W_1	$8.4 + 1.5/ -0$
W_2 max.	14.4

DIMENSIONS: MM

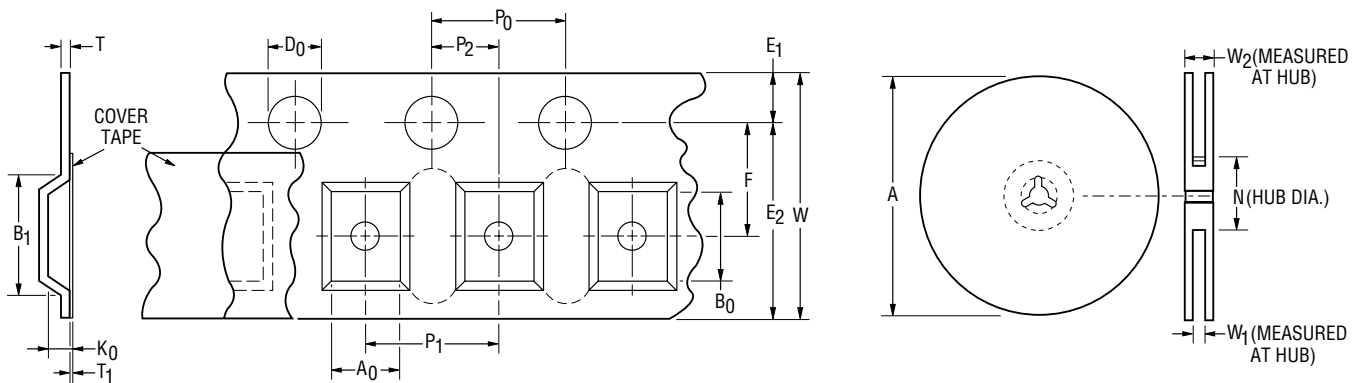

Specifications are subject to change without notice.

Built according to UL 248-14 (formerly 198G) and CSA C22.2 no. 248.14 (formerly 59.2M). U.S. patent pending.

Approvals:

UL recognition 1A - 5A File #E41599/39328
 CSA certification 1A - 5A File #LR51172/38456

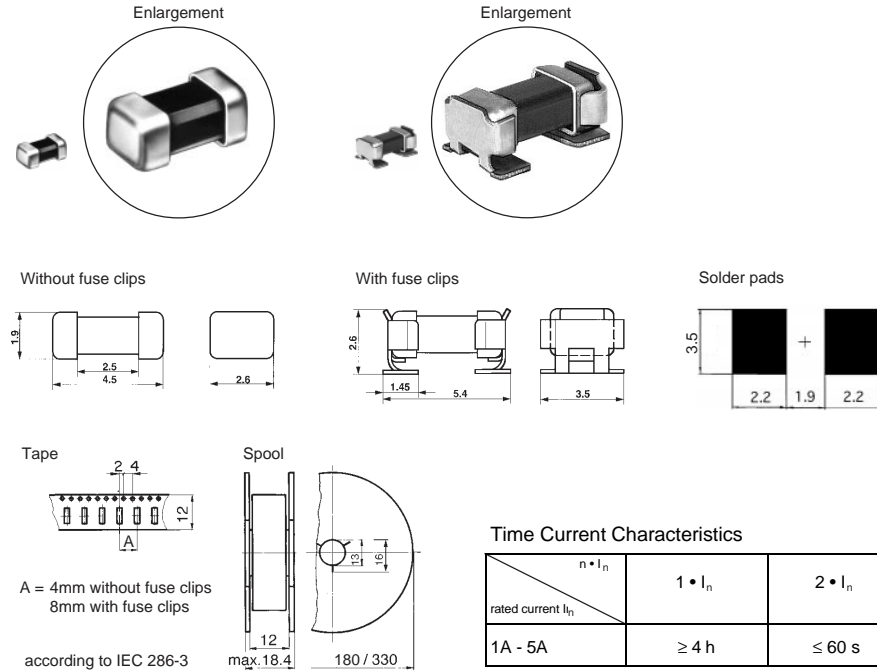
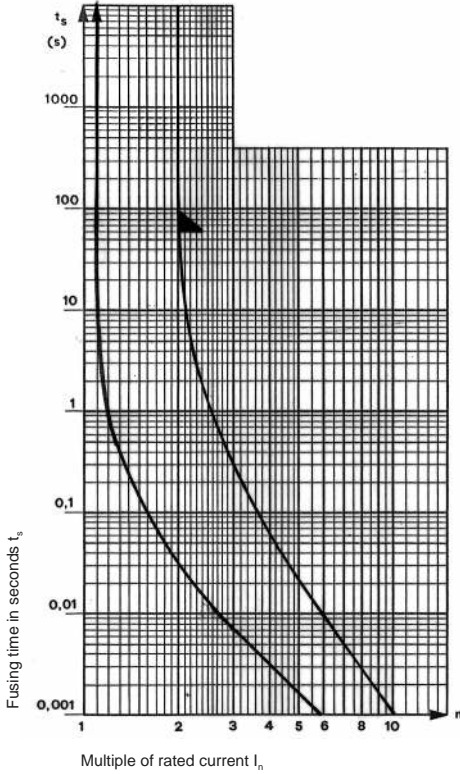

Time Current Characteristics

rated current I_n	$n \cdot I_n$	$1 \cdot I_n$	$2 \cdot I_n$
	1A - 5A	≥ 4 h	≤ 60 s

Technical Data

Rated voltage U_n	63V AC/DC
Rated current	see chart
Time current characteristic	super quick-acting, see chart for values
Breaking capacity	50A/63V AC/DC p.f.1
Max. storage temperature	40°C / 70% relative humidity
Ambient temperature max. T_{amb}	-40°C to +125°C
Vibration resistance	Frequency 10-2000 Hz, cross-over frequency 60 Hz, resp. acceleration 100 m/s ² according to IEC 68-2-6, Test Fc
Shock resistance	981 m/s ² , 6 ms, according to IEC 68-2-27, Test Ea
Climatic category	HPF according to DIN 40040
Solderability: reflow and wave soldering for suprafuse reflow soldering only for suprafuse with clips	235°C / 2 sec. according to IEC 68-2-58 / Td
Soldering heat resistance	260°C / 10 sec. according to IEC 68-2-58 / Td
Material: Housing End caps	temperature resistant plastic (UL 94V-0) brass, gold-plated
Net weight	5 g suprafuse; 6.5 g suprafuse with clips

Order Numbers	Rated current / voltage A / V	Voltage drop at I_n typical mV	Power dissipation at I_n typical Watts	Fusing integral $I^2 t$ at $10 \cdot I_n$ typical A ² s	Packaging Order Number Suffix
3405.2207.XX	1 A / 63V	120	0.11	0.10	Without fuse clips: * 100 pcs taped & reeled: .XX = .10 2,000 pcs taped & reeled: .XX = .12 8,000 pcs taped & reeled: .XX = .12 With fuse clips: * 100 pcs taped & reeled: .XX = .20 750 pcs taped & reeled: .XX = .25 3,000 pcs taped & reeled: .XX = .26 * smaller quantities available taped, in bag
3405.2208.XX	1.25 A / 63V	120	0.13	0.18	
3405.2209.XX	1.5 A / 63V	120	0.19	0.25	
3405.2210.XX	2 A / 63V	95	0.19	0.50	
3405.2211.XX	2.5 A / 63V	80	0.20	0.60	
3405.2212.XX	3 A / 63V	80	0.24	0.90	
3405.2213.XX	3.5 A / 63V	75	0.26	1.20	
3405.2214.XX	4 A / 63V	70	0.30	1.60	
3405.2215.XX	5 A / 63V	65	0.33	2.50	

Built according to IEC 127-4/2; EN 60127-4/2; UL 248-14 (formerly 198G) and CSA C22.2 no. 248.14 (formerly 59.2M). U.S. patent pending.

Approvals:

UL recognition 800mA-4A File #E41599/39328
 CSA certification 800mA-4A File #LR51172/38456
 * VDE approvals 800mA-1.25A and 2.5A only for version without clip

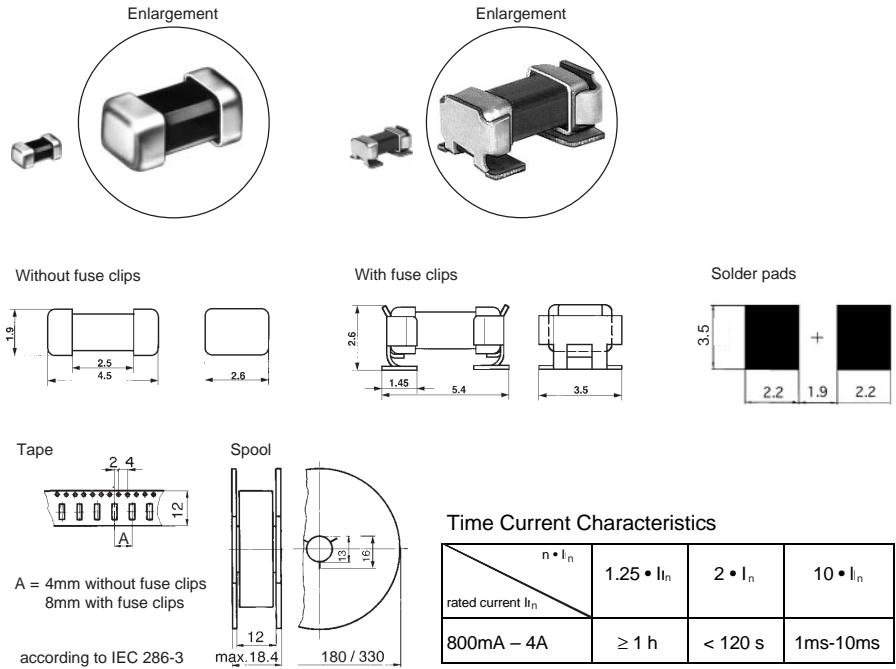
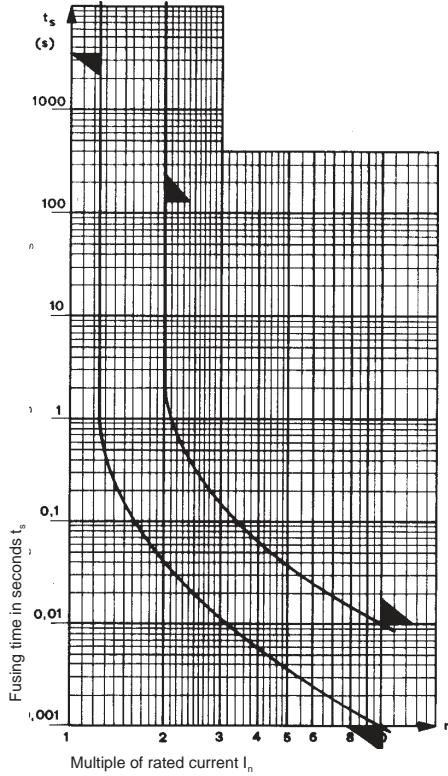

Time Current Characteristics

$n \cdot I_n$	$1.25 \cdot I_n$	$2 \cdot I_n$	$10 \cdot I_n$
rated current I_n			
800mA - 4A	≥ 1 h	< 120 s	1ms-10ms

Technical Data

Rated voltage Un	63V AC/DC
Rated current	see chart
Time current characteristic	quick-acting, see chart for values
Breaking capacity	100A/63V AC/DC p.f.1
Max. storage temperature	40°C / 70% relative humidity
Ambient temperature max. Tamb	-40°C to +125°C
Vibration resistance	Frequency 10-2000 Hz, cross-over frequency 60 Hz, resp. acceleration 100 m/s ² according to IEC 68-2-6, Test Fc
Shock resistance	981 m/s ² , 6 ms, according to IEC 68-2-27, Test Ea
Climatic category	HPF according to DIN 40040
Solderability: reflow and wave soldering for suprafuse reflow soldering only for suprafuse with clips	235°C / 2 sec. according to IEC 68-2-58 / Td
Soldering heat resistance	260°C / 10 sec. according to IEC 68-2-58 / Td
Material: Housing	temperature resistant plastic (UL 94V-0)
End caps	brass, gold-plated
Net weight	5 g suprafuse; 6.5 g suprafuse with clips

Order Numbers	Rated current / voltage	Voltage drop at I_n		Power dissipation at $1.25 \cdot I_n$		Fusing integral $I^2 t$ at $10 \cdot I_n$	Packaging
		max. IEC 127 mV	typical Schurter mV	max. IEC 127 Watts	typical Schurter Watts		
Series SFC 63V	mA / A / V					typical A ² s	Order Number Suffix
3405.0917.XX	800mA / 63V	400	150	0.5	0.24	0.16	Without fuse clips: *
3405.0918.XX	1A / 63V	300	140	0.5	0.28	0.20	100 pcs taped & reeled: .XX=.10
3405.0919.XX	1.25A / 63V	300	130	1.0	0.33	0.40	2,000 pcs taped & reeled: .XX=.11
3405.0920.XX	1.6A / 63V	300	120	1.0	0.40	0.60	8,000 pcs taped & reeled: .XX=.12
3405.0921.XX	2A / 63V	300	120	1.0	0.48	0.80	With fuse clips: *
3405.0922.XX	2.5A / 63V	300	100	1.0	0.50	1.90	100 pcs taped & reeled: .XX = .20
3405.0923.XX	3.15A / 63V	300	90	1.2	0.50	2.70	750 pcs taped & reeled: .XX = .25
3405.0924.XX	4A / 63V	300	80	1.5	0.60	2.10	3,000 pcs taped & reeled: .XX = .26

* smaller quantities available taped, in bag

OMF 63V Quick-acting Surface Mount Fuse



UL 248-14 (formerly 198G)
CSA C22.2 No. 248.14 (formerly 95.2M)

Approvals:

UL recognition 63mA-10A File #E41599
CSA certification 63mA-10A File #LR51172

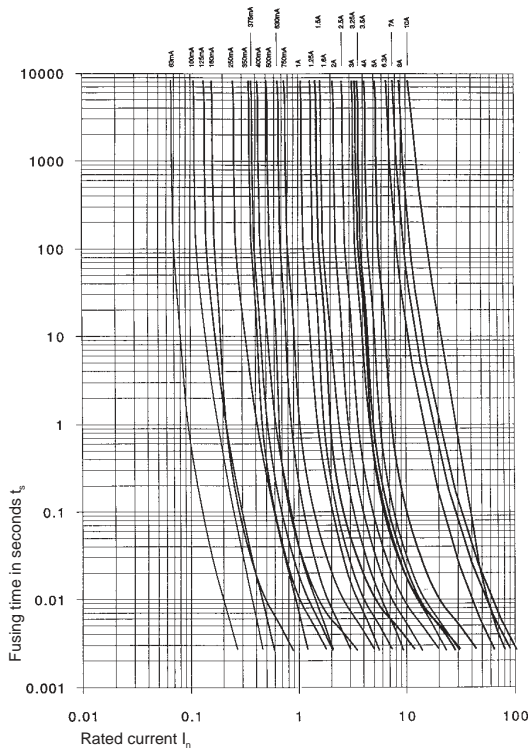

Enlargement

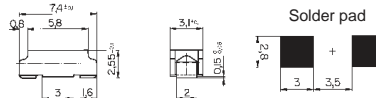
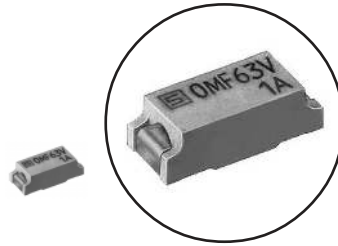

Tape and Spool

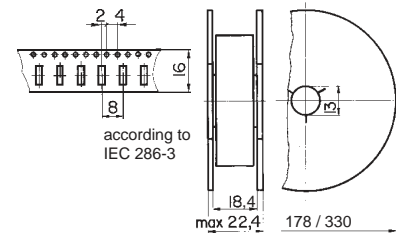

Series OMK 63V: OMF 63 fuse available pre-installed into OMH 63 SMD fuseholder

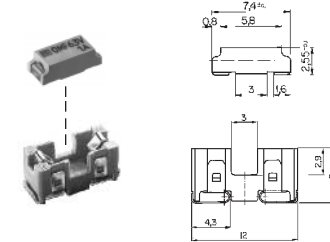

See the following page for ordering information

Time Current Characteristics

rated current I _n	n • I _n		
	I _n	2 • I _n	4 • I _n
63mA – 5A	≥ 4 h	< 1 s	<10 ms
6.3A – 8A	≥ 4 h	< 5 s	<50 ms
10A	≥ 4 h	< 20 s	<60 ms

Technical Data

Rated voltage U_n	63 V AC/DC
Rated current	see chart
Time current characteristic	quick-acting, see chart for values (low I ² t)
Marking	OMF 63V, rated current, rated voltage, , UL, CSA
Max. storage temperature	40°C / 70% relative humidity
Ambient temperature max. T_{amb}	-40°C to +85°C
Vibration resistance	Frequency 10-2000 Hz, cross-over frequency 60 Hz, resp. acceleration 100 m/s ² (10g) according to IEC 68-2-6, Test Fc
Shock resistance	981 m/s ² , 6 ms, according to IEC 68-2-27, Test Ea
Climatic category	HPF according to DIN 40040
Solderability (reflow and wave soldering)	235°C / 2 sec. according to IEC 68-2-58 / Td
Soldering heat resistance	260°C / 10 sec. according to IEC 68-2-58 / Td
Material: Housing	temperature resistant plastic (UL 94V-0)
Terminals	brass, tin-plated
Net weight (per hundred)	10 g

Order Numbers	Rated curr. / voltage mA / A / V ~	Breaking capacity A ~ ac / dc	Voltage Drop at I _n		Power diss. at I _n typical Watts	Fusing I ² t at 4 • I _n		Packaging Order No. Suffix
			typ. mV			typical A ² s	max. A ² s	
3402.0003.XX	63 mA / 63V	50A / 63V AC/DC p.f./ cos w 1	2550	0.2	0.00011	0.00064	OMF 63V packaged loose: .XX = .11 750 pieces taped & reeled: .XX = .22 3,000 pieces taped & reeled: .XX = .24	
3402.0004.XX	100 mA / 63V		1770	0.2	0.0067	0.0016		
3402.0049.XX	125 mA / 63V		1770	0.2	0.0011	0.0025		
3402.0005.XX	160 mA / 63V		1700	0.3	0.0018	0.0041		
3402.0006.XX	250 mA / 63V		430	0.1	0.0045	0.01		
3402.0043.XX	350 mA / 63V		430	0.2	0.0084	0.02		
3402.0044.XX	375 mA / 63V		410	0.2	0.011	0.023		
3402.0007.XX	400 mA / 63V		360	0.2	0.0096	0.026		
3402.0045.XX	500 mA / 63V		350	0.2	0.016	0.04		
3402.0008.XX	630 mA / 63V		350	0.2	0.023	0.064		
3402.0046.XX	750 mA / 63V		300	0.2	0.052	0.09		
3402.0009.XX	1 A / 63V		220	0.2	0.086	0.16		
3402.0010.XX	1.25 A / 63V		220	0.3	0.14	0.25		
3402.0047.XX	1.5 A / 63V		200	0.3	0.24	0.36		
3402.0011.XX	1.6 A / 63V		200	0.3	0.27	0.41		
3402.0012.XX	2 A / 63V		200	0.4	0.44	0.64		
3402.0013.XX	2.5 A / 63V		190	0.5	0.79	1.0		
3402.0014.XX	3 A / 63V		190	0.6	1.1	1.4		
3402.0048.XX	3.15 A / 63V		190	0.6	1.1	1.6		
3402.0015.XX	3.5 A / 63V		140	0.5	1.6	2.0		
3402.0016.XX	4 A / 63V		140	0.6	2.1	2.6		
3402.0017.XX	5 A / 63V		140	0.7	2.9	4.0		
3402.0018.XX *	6.3 A / 63V		110 *	0.7	14	32		
3402.0019.XX *	7 A / 63V		105 *	0.7	16	39		
3402.0020.XX *	8 A / 63V	100 *	0.8	20	51			
3402.0040.XX *	10 A / 63V	80 *	0.8	54	96			

* Trace width of test board outlined in IEC 127-4/9: ≥5mm for 6.3A & 7A; ≥10mm for 8A & 10A. Acceptability is determined in the end use application.

OMK 63V Quick-acting Surface Mount Fuse and Fuseholder



Built according to CSA 59.2-M. U.S. Patented.

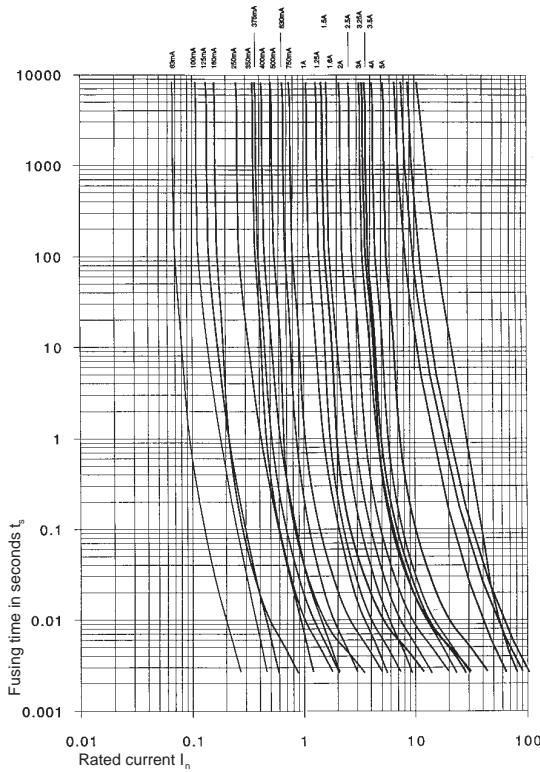

Approvals:
 UL recognition 63mA-10A File #E41599
 CSA certification 63mA-10A File #LR51172
Fuse File #E41599
Fuseholder File #E39328
 File #LR38456
 ** 6.3A-10A fuse available separately; see previous page.

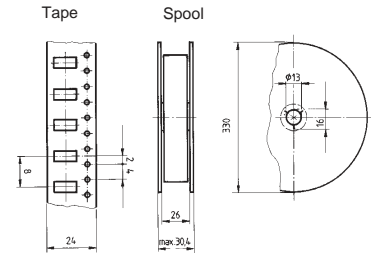
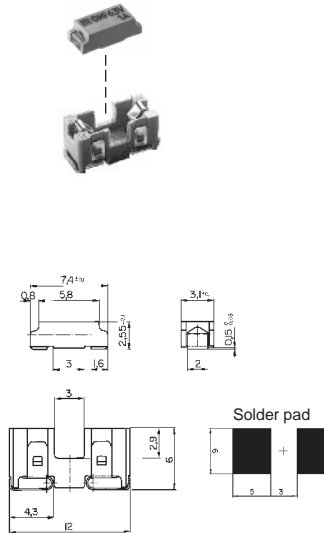

according to IEC 286-3

Time Current Characteristics

rated current I _n	n • I _n	I _n	2 • I _n	4 • I _n
	63mA – 5A	≥ 4 h	< 1 s	< 10 ms

Technical Data

Rated voltage U_n	63 V AC/DC
Rated current	see chart
Time current characteristic	quick-acting, see chart for values (low I ² t)
Marking	OMF 63V, rated current, rated voltage, UL, CSA
Max. storage temperature	40°C / 70% relative humidity
Ambient temperature max. T_{amb}	-40°C to +85°C
Vibration resistance	Frequency 10-2000 Hz, cross-over frequency 60 Hz, resp. acceleration 100 m/s ² (10g) according to IEC 68-2-6, Test Fc
Shock resistance	981 m/s ² , 6 ms, according to IEC 68-2-27, Test Ea
Climatic category	HPF according to DIN 40040
Solderability (reflow and wave soldering)	235°C / 2 sec. according to IEC 68-2-58 / Td
Soldering heat resistance	260°C / 10 sec. according to IEC 68-2-58 / Td
Material: Housing	temperature resistant plastic (UL 94V-0)
Terminals	brass, tin-plated
Net weight (per hundred)	47 g

Order Numbers	Rated curr. / voltage mA / A / V ~	Breaking capacity A ~ ac / dc	Voltage drop at I _n typical mV	Power dissipation at I _n typical Watts	Fusing I ² t at 4 • I _n		Packaging Order No. Suffix
					typical A ² s	max. A ² s	
3422.0003.XX	63 mA / 63V	50A / 63V	2550	0.2	0.00011	0.00064	OMK 63V packaged loose: .XX = .11 1,500 pieces taped & reeled: .XX = .23
3422.0004.XX	100 mA / 63V		1770	0.2	0.00067	0.0016	
3422.0049.XX	125 mA / 63V		1770	0.2	0.0011	0.0025	
3422.0005.XX	160 mA / 63V		1700	0.3	0.0018	0.0041	
3422.0006.XX	250 mA / 63V		430	0.1	0.0045	0.01	
3422.0043.XX	350 mA / 63V		430	0.2	0.0084	0.02	
3422.0044.XX	375 mA / 63V		410	0.2	0.011	0.023	
3422.0007.XX	400 mA / 63V		360	0.2	0.0096	0.026	
3422.0045.XX	500 mA / 63V		350	0.2	0.016	0.04	
3422.0008.XX	630 mA / 63V		350	0.2	0.023	0.064	
3422.0046.XX	750 mA / 63V		300	0.2	0.052	0.09	
3422.0009.XX	1 A / 63V		220	0.2	0.086	0.16	
3422.0010.XX	1.25 A / 63V		220	0.3	0.14	0.25	
3422.0047.XX	1.5 A / 63V		200	0.3	0.24	0.36	
3422.0011.XX	1.6 A / 63V		200	0.3	0.27	0.41	
3422.0012.XX	2 A / 63V		200	0.4	0.44	0.64	
3422.0013.XX	2.5 A / 63V		190	0.5	0.79	1.0	
3422.0014.XX	3 A / 63V		190	0.6	1.1	1.4	
3422.0048.XX	3.15 A / 63V		190	0.6	1.1	1.6	
3422.0015.XX	3.5 A / 63V		140	0.5	1.6	2.0	
3422.0016.XX *	4 A / 63V	140 *	0.6	2.1	2.6		
3422.0017.XX *	5 A / 63V	140 *	0.7	2.9	4.0		

*3.5A max.recommended R_{MS} current.5A possible at 12 (trace width 6 test board outlined in I E 127-4/9 is 10m m). Acceptability determined in end use application.

OMF 125V Quick-acting Surface Mount Fuse - High Breaking Capacity



UL 248-14 (formerly 198G)
CSA C22.2 No 248.14 (formerly 59.2M)

NEW

Surge tolerant version for telecom: see page 162

Approvals:

UL recognition 63mA-10A File #E41599
CSA certification 63mA-10A File #LR51172

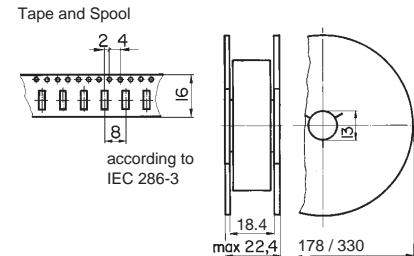
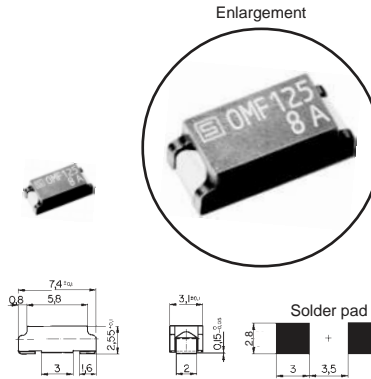
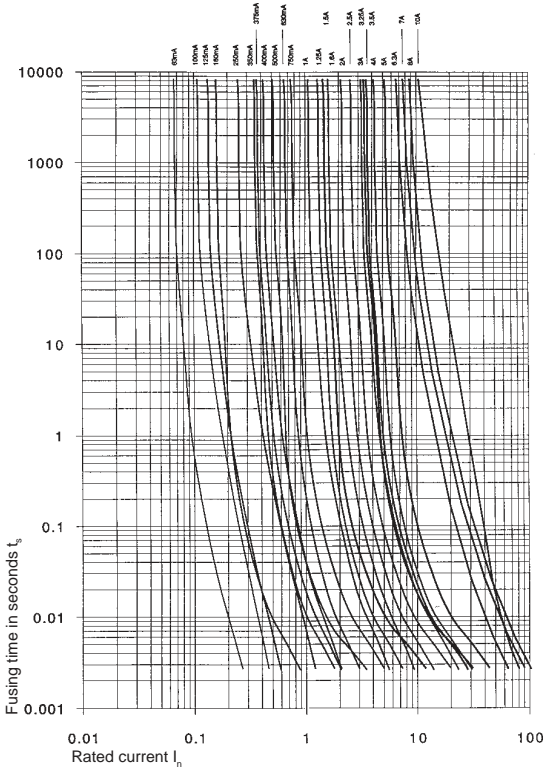

Series OMK 125V: OMF 125 fuse available pre-installed into OMH 125 SMD fuseholder

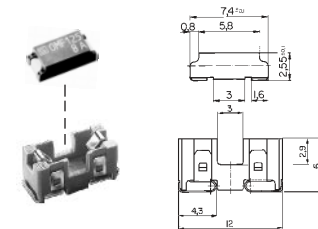

See the following page for ordering information

Time Current Characteristics

$n \cdot I_n$	I_n	$2 \cdot I_n$	$4 \cdot I_n$
rated current I_n			
63mA - 5A	≥ 4 h	< 1 s	< 10 ms
6.3A - 8A	≥ 4 h	< 5 s	< 50 ms
10A	≥ 4 h	< 20 s	< 60 ms

Technical Data

Rated current	see chart
Time current characteristic	quick-acting, see chart for values (low I^2t)
Marking	OMF 125, rated current, rated voltage, , UL, CSA
Max. storage temperature	40°C / 70% relative humidity
Ambient temperature max. T_{amb}	-40°C to +125°C
Vibration resistance	Frequency 10-2000 Hz, cross-over freq. 60 Hz, amplitude 0.75 mm, resp. acceleration 100 m/s ² (10g) according to IEC 68-2-6, Test Fc
Shock resistance	981 m/s ² , 6 ms, according to IEC 68-2-27, Test Ea
Climatic category	HPF according to DIN 40040
Solderability (reflow and wave soldering)	235°C / 2 sec. according to IEC 68-2-58 / Td
Soldering heat resistance	260°C / 10 sec. according to IEC 68-2-58 / Td
Material: Housing	temperature resistant plastic (UL 94V-0)
Terminals	brass, tin-plated
Net weight (per hundred)	10 g

Order Numbers	Rated Current / Voltage mA / A / V ~	Breaking Capacity A ~ AC / DC	Volt. drop at In typ. mV	Power Diss. at In typical Watts	Fusing I^2t at 4 • In		Packaging Order No. Suffix
					typical A ² s	max. A ² s	
3404.0003.XX	63 mA /125V	63mA-7A: 300 A AC 400A DC 125V pf 1	2550	0.160	0.00011	0.00064	packaged loose: .XX = .11
3404.0004.XX	100 mA /125V		1770	0.180	0.0067	0.0016	
3404.0049.XX	125 mA /125V		1770	0.220	0.0011	0.0025	
3404.0005.XX	160 mA /125V		1700	0.270	0.0018	0.0041	
3404.0006.XX	250 mA /125V		990	0.250	0.0045	0.01	
3404.0043.XX	350 mA /125V		990	0.347	0.0084	0.02	
3404.0044.XX	375 mA /125V		990	0.371	0.0011	0.023	
3404.0007.XX	400 mA /125V		960	0.384	0.011	0.026	
3404.0045.XX	500 mA /125V		300	0.150	0.016	0.04	
3404.0008.XX	630 mA /125V		290	0.183	0.023	0.064	
3404.0046.XX	750 mA /125V	260	0.195	0.052	0.09		
3404.0009.XX	1 A /125V	8A: 200A AC 300A DC 125V pf 1	220	0.220	0.086	0.16	750 pieces taped & reeled: .XX = .22
3404.0010.XX	1.25 A /125V		220	0.280	0.14	0.25	
3404.0047.XX	1.5 A /125V		200	0.320	0.24	0.36	
3404.0011.XX	1.6 A /125V		200	0.3	0.27	0.41	
3404.0012.XX	2 A /125V		200	0.4	0.44	0.64	
3404.0013.XX	2.5 A /125V		190	0.480	0.79	1.0	
3404.0014.XX	3 A /125V		190	0.570	1.1	1.4	
3404.0048.XX	3.15 A /125V		190	0.6	1.1	1.6	
3404.0015.XX	3.5 A /125V		140	0.490	1.6	2.0	
3404.0016.XX	4 A /125V		140	0.560	2.1	2.6	
3404.0017.XX	5 A /125V	140	0.7	2.9	4.0		
3404.0018.XX *	6.3 A /125V	110 *	0.690	14	32		
3404.0019.XX *	7 A /125V	105 *	0.740	16	39		
3404.0020.XX *	8 A /125V	100 *	0.8	20	51		
3404.0021.XX *	10 A /125V	80 *	0.8	54	96		

* Trace width of test board outlined in IEC 127-4/9: ≥ 5 mm for 6.3A & 7A; ≥ 10 mm for 8A & 10A. Acceptability determined in end use application.

OMK 125V Quick-acting Surface Mount Fuse and Fuseholder - High Breaking Capacity



Built according to CSA 59.2-M. U.S. Patented. UL, CSA approval tests according to manufacturer specifications.

Approvals:
 UL recognition 63mA-5A** File #E41599 File #E39328
 CSA certification 63mA-5A** File #LR51172 File #LR38456
 ** 6.3A-10A fuse available separately; see previous page.

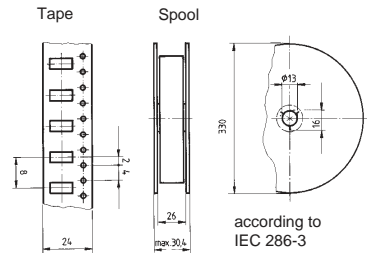
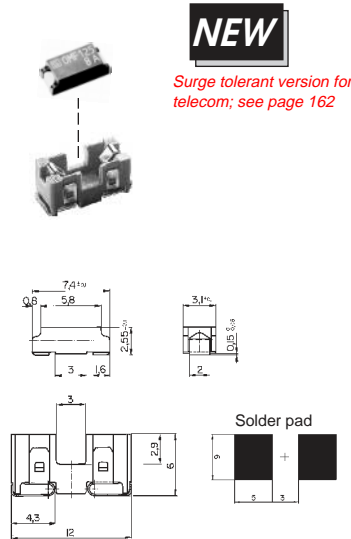
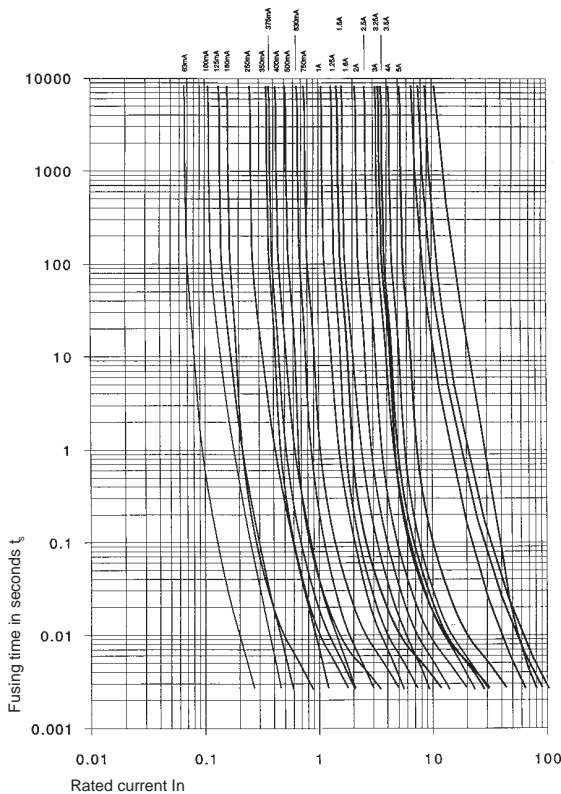

Time Current Characteristics

rated current I_n	$n \cdot I_n$	$2 \cdot I_n$	$4 \cdot I_n$
	$\geq 4 \text{ h}$	$< 1 \text{ s}$	$< 10 \text{ ms}$

Technical Data

Rated voltage U_n	125 V AC/DC
Rated current	see chart
Time current characteristic	quick-acting, see chart for values (low I^2t)
Marking	OMF 125V, rated current, rated voltage, , UL, CSA
Max. storage temperature	40°C / 70% relative humidity
Ambient temperature max. T_{amb}	-40°C to +85°C
Vibration resistance	Frequency 10-2000 Hz, cross-over frequency 60 Hz, resp. acceleration 100 m/s ² (10g) according to IEC 68-2-6, Test Fc
Shock resistance	981 m/s ² , 6 ms, according to IEC 68-2-27, Test Ea
Climatic category	HPF according to DIN 40040
Solderability (reflow and wave soldering)	235°C / 2 sec. according to IEC 68-2-58 / Td
Soldering heat resistance	260°C / 10 sec. according to IEC 68-2-58 / Td
Material: Housing	temperature resistant plastic (UL 94V-0)
Terminals	brass, tin-plated
Net weight (per hundred)	58 g

Order Numbers	Rated current / voltage mA / A / V ~	Breaking capacity A ~ ac / dc	Voltage drop at I_n typical mV	Power dissipation at I_n typical Watts	Fusing $I^2 t$ at $4 \cdot I_n$		Packaging Order No. Suffix
					typical A ² s	max. A ² s	
3404.2303.XX	63 mA / 125V	300 A ac / 400A dc 125V pf 1	2550	0.2	0.00011	0.00064	OMK 125V packaged loose: .XX = .11 1,500 pieces taped & reeled: .XX = .23
3404.2304.XX	100 mA / 125V		1770	0.2	0.00067	0.0016	
3404.2349.XX	125 mA / 125V		1770		0.0011	0.0025	
3404.2305.XX	160 mA / 125V		1700		0.0018	0.0041	
3404.2306.XX	250 mA / 125V		430		0.0045	0.01	
3404.2343.XX	350 mA / 125V		430	0.27	0.0084	0.02	
3404.2344.XX	375 mA / 125V		410	0.3	0.011	0.023	
3404.2307.XX	400 mA / 125V		360	0.1	0.0096	0.026	
3404.2345.XX	500 mA / 125V		350	0.3	0.016	0.04	
3404.2308.XX	630 mA / 125V		350	0.2	0.023	0.064	
3404.2346.XX	750 mA / 125V		300	0.3	0.052	0.09	
3404.2309.XX	1 A / 125V		220	0.2	0.086	0.16	
3404.2310.XX	1.25 A / 125V		220	0.3	0.14	0.25	
3404.2347.XX	1.5 A / 125V		200	0.45	0.24	0.36	
3404.2311.XX	1.6 A / 125V		200	0.3	0.27	0.41	
3404.2312.XX	2 A / 125V		200	0.4	0.44	0.64	
3404.2313.XX	2.5 A / 125V		190	0.4	0.79	1.0	
3404.2314.XX	3 A / 125V		190	0.4	1.1	1.4	
3404.2348.XX	3.15 A / 125V		190		1.1	1.6	
3404.2315.XX	3.5 A / 125V		140		1.6	2.0	
3404.2316.XX *	4 A / 125V	140 *		2.1	2.6		
3404.2317.XX *	5 A / 125V	140 *		2.9	4.0		

*3.5A max. recommended RMS current. 5A RMS possible at 12V (trace width of test board outlined in IEC 127-4/9 is 10mm). Acceptability determined in end use application

OMF/OMT 125V/250V OMF Quick-acting, OMT Time Lag Surface Mount Fuses



IEC 127-4/2; EN 60127-4/2
 UL 248-14 (formerly 198.G)
 CSA C22.2 No. 248.14 (formerly 59.2M)

NEW

Surge tolerant / telecom version for OMF: see page 162

Enlargement

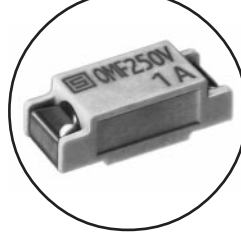

OMF Approvals:

UL recognition 250mA-4A File #E41599
 CSA certification 250mA-4A File #LR51172
 VDE approval 250mA-4A* File #6079, expert report
 * 250mA-4A using wave solder process
 250mA-2.5A using reflow solder process

OMT Approvals:

UL recognition 750mA-2A/250V File #E41599
 2.5A-5A/125V File #E41599
 CSA certification 750mA-2A/250V File #E41599
 2.5A-5A/125V File #E41599

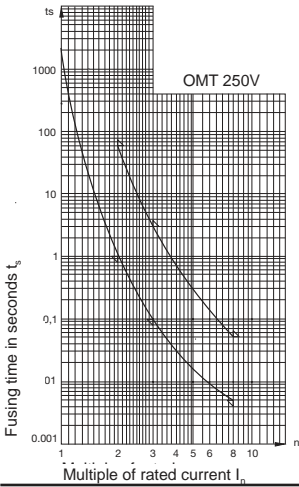
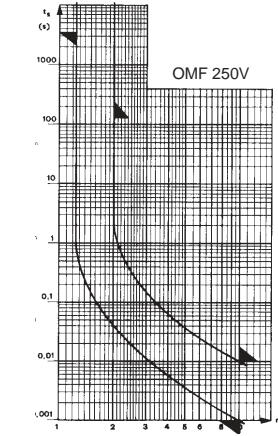

OMF Pre-arcing time/current characteristics (at Tamb 23°C)

rated current I _n	n • I _n	1.25 • I _n *	2 • I _n	10 • I _n
		250mA - 4A	IEC / UL	> 1 h
	CSA	> 1 h	< 60s	1 ms - 10 ms

*non-fusing current I_nf

OMT Pre-arcing time/current characteristics (at Tamb 23°C)

rated current I _n	n • I _n	1 • I _n *	2 • I _n	3 • I _n	8 • I _n
		UL	UL		
		min.	min.	min.	min.
750mA - 5A		4 h	1 s	60 s	100 ms
			max.	max.	max.
			100 ms	3 s	5 ms
					50 ms

*non-fusing current I_nf

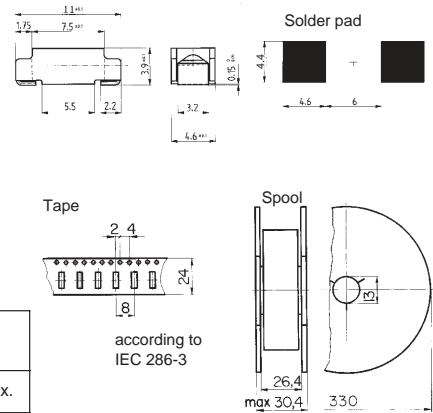

Technical Data

Rated voltage U_n	OMF: 250V AC/DC, OMT: 125V/250V AC
Rated current	see chart
Time current characteristic	OMF quick-acting, see chart for values (low I ² t) OMT time-lag, see chart for values (low I ² t)
Marking	OMF 250 / OMT 250 / OMT 125, rated current, rated voltage, logo, UL
Breaking capacity	see chart
Max. storage temperature	40°C / 70% relative humidity
Ambient temperature max. Tamb	OMF: -40°C to +125°C OMT: -40°C to +85°C
Vibration resistance	Frequency 10-2000 Hz, cross-over frequency 60 Hz, resp. acceleration 198 m/s ² (OMF), 196 m/s ² (OMT); according to IEC 68-2-6, Test Fc
Shock resistance	981 m/s ² , 6 ms, according to IEC 68-2-27
Climatic category	OMF: HPF according to DIN 40040 OMT: GPF according to DIN 40040
Solderability (reflow and wave soldering)	235°C / 2 sec. according to IEC 68-2-58 / Td
Soldering heat resistance	260°C / 10 sec. according to IEC 68-2-58 / Td
Material: Housing	temperature resistant plastic (UL 94V-0)
Terminals	brass, tin-plated
Net weight (per hundred)	35 g

Order Numbers	Rated curr. / voltage	Breaking Capacity	Volt. drop @ I _n	Power diss. @ I _n	Fusing I ² t at 4 • I _n	Order Numbers	Rated curr. / voltage	Breaking capacity	Volt. drop at I _n	Power diss. at 4 • I _n	Pre-arcing I ² t at 8 • I _n	Packaging	
Series OMF 250V	mA / A / V -	A - ac / dc	max. mV	typical Watts	typical A ² s	Series OMT 250V	mA / A / V -	A - ac / dc	typical mV	typical mW	typical A ² s	Order No. Suffix	
3403.0010.XX	250 mA / 250V	100A / 250V AC p.f. = 1	800	0.109	0.009	3403.0129.XX	750 mA / 250V	100A / 250V AC	107	80	0.3	OMF 250V packaged loose: .XX = .11 2,000 pieces taped & reeled: .XX = .24 OMT 250V packaged loose: .XX = .11 2,000 pieces taped & reeled: .XX = .24	
3403.0011.XX	315 mA / 250V		750	0.125	0.017	0.099	3403.0116.XX	1 A / 250V	90	90	0.6		
3403.0012.XX	400 mA / 250V		700	0.19	0.02	0.16	3403.0117.XX	1.25 A / 250V	p.f. = 1	89	111		1
3403.0013.XX	500 mA / 250V		600	0.19	0.04	0.25	3403.0130.XX	1.5 A / 250V	50A / 250V AC	74	111		2
3403.0014.XX	630 mA / 250V		500	0.23	0.08	0.4	3403.0119.XX	2 A / 250V	p.f. = 1	69	138		4
3403.0015.XX	800 mA / 250V		400	0.33	0.13	0.64	3403.0120.XX	2.5 A / 125V	100A / 125V AC	68	170		7
3403.0016.XX	1 A / 250V		300	0.39	0.23	1	3403.0131.XX	3 A / 125V	p.f. = 1	62	186		12
3403.0017.XX	1.25 A / 250V		300	0.39	0.47	1.53	3403.0132.XX	3.5 A / 125V		60	210		19
3403.0018.XX	1.6 A / 250V		300	0.49	0.84	2.56	3403.0122.XX	4 A / 125V		60	240		23
3403.0019.XX	2 A / 250V		300	0.6	1.4	4	3403.0123.XX	5 A / 125V		57	285		37

MELF/MKF 125V Quick-acting Surface Mount Fuses - High Breaking Capacity

NEW

UL 248-14 (formerly 198.G)
CSA C22.2 No. 248.14 (formerly 59.2M)

MELF Approvals: (reference series 172876)

UL recognition 125mA-7A/125V File #E42088
CSA certification 125mA-7A/125V File #LR34549

MKF Approvals

UL recognition 125mA-4A/125V; 5A-7A/63V File #E42088
CSA certification 125mA-7A/125V File #LR34549

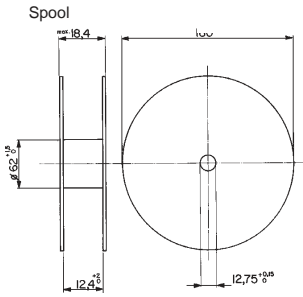
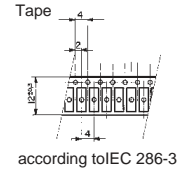
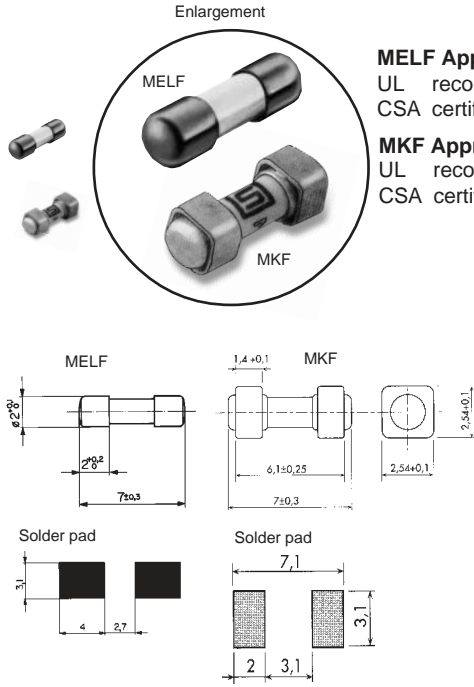
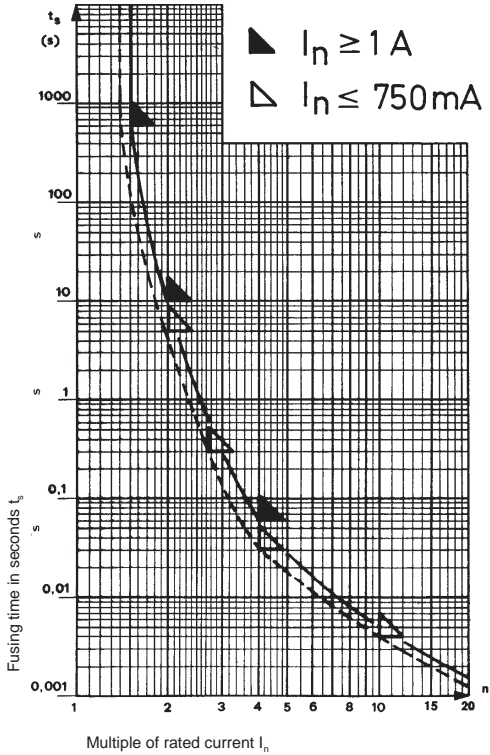

Time Current Characteristics (Tamb = 25°C)

rated current I_n	$n \cdot I_n$					
	I_n	$1.5 \cdot I_n$	$2 \cdot I_n$	$2.75 \cdot I_n$	$4 \cdot I_n$	$10 \cdot I_n$
	min.	max.	max.	max.	max.	max.
125mA – 750mA	4 h	–	5 s	300 ms	30 ms	4 ms
1A – 7A	4 h	600 s	10 s	–	60 ms	–



For information about Melf miniature SMD and through-hole mount fuseholders, see page 87

Technical Data

Rated voltage Un	125 V AC/DC
Rated current	see chart
Time current characteristic	quick-acting, see chart for values
Marking	on fuse: rated current, logo; on smallest package: type, rated current, volts, breaking capacity, logo, UL, CSA
Ambient temperature max. Tamb	-55°C to +85°C
Solderability (reflow and vapor phase)	235°C/2 sec. (IEC 68-2-58/Td)
Soldering heat resistance	235°C/5 sec. (IEC 68-2-58/Td)
Material: Housing	ceramic
End caps	brass, tin-plated
Net weight (per hundred)	MELF 7g MKF 14.5g

Order Numbers	Rated curr. / voltage	Breaking Capacity	Volt. drop @ I_n	Power diss. @ I_n	Pre-arcing I2t at 10 • I_n	Order Numbers	Rated curr. / voltage	Breaking capacity	Volt. drop at I_n	Power diss. at I_n	Pre-arcing I2t at 10 • I_n	Packaging
Series MELF 125V	mA / A / V -	A - ac / dc	max. mV	max. mW	A2s	Series MKF 125V	mA / A / V -	A - ac / dc	max. mV	mW	A2s	Order No. Suffix
7010.9760.XX*	125 mA /125V	on printed boards	810	105	0.0036	7010.9901.XX	125 mA /125V		750	94	0.0024	MELF 125V
7010.9770.XX	250 mA /125V	300A /125V AC	295	74	0.0094	7010.9902.XX	250 mA /125V		320	80	0.0094	100 pieces packaged
7010.9780.XX	375 mA /125V	cos w=1	225	85	0.019	7010.9903.XX	375 mA /125V		240	90	0.021	loose: XX = .63
7010.9790.XX	500 mA /125V	300A / 125V DC, L/R = 1 ms	235	120	0.07	7010.9904.XX	500 mA /125V		250	125	0.038	500 pieces packaged
7010.9800.XX	750 mA /125V		225	170	0.18	7010.9905.XX	750 mA /125V		220	165	0.085	loose: XX = .55
7010.9810.XX	1 A /125V	inserted into fuseholder	190	190	0.3	7010.9906.XX	1 A /125V	300A / 125V AC/DC	180	180	0.15	1,500 pieces taped & reeled: XX = .57
7010.9820.XX	1.5 A /125V	In 125mA-4A: 300A / 125V AC	210	315	0.38	7010.9907.XX	1.5 A /125V	p.f. = 1	210	315	0.45	
7010.9830.XX	2 A /125V	cos w = 1	175	350	1.1	7010.9908.XX	2 A /125V	300A / 125V DC	170	340	0.95	MKF 125V packaged loose: XX = .03
7010.9840.XX	2.5 A /125V	300A/125V DC, L/R = 1 ms	160	400	1.4	7010.9909.XX	2.5 A /125V	L/R = 1 ms	165	413	1.4	loose: XX = .55
7010.9850.XX	3 A /125V		155	465	2	7010.9910.XX	3 A /125V		160	480	2.2	500 pieces packaged
7010.9860.XX	3.5 A /125V	In 5A-7A: 300A/125V AC	145	510	2.6	7010.9911.XX	3.5 A /125V		160	560	2.8	loose: XX = .55
7010.9870.XX	4 A /125V	cos = 1	165	660	4	7010.9912.XX	4 A /125V		180	720	4	1,500 pieces taped & reeled: XX = .57
7010.9880.XX	5 A /125V	50A/125V DC, L/R = 1 ms	155	775	6.2	7010.9913.XX	5 A /125V		170	850	6.8	
7010.9890.XX**	7 A /125V		125	875	13	7010.9914.XX	7 A /125V		180	1260	10	

* 125mA fuse: clearing times should be determined in the end use application, according to UL Conditions of Acceptability
**7A fuse: when used in conjunction with Melf holder, UL acceptability is determined in the end use application

MSB/MKT 125V Time-lag Surface Mount Fuses - Low Breaking Capacity



IEC 60127-4/2, EN 60127-4/2
CSA C22.2 No. 248.14 (formerly 59.2M)

NEW

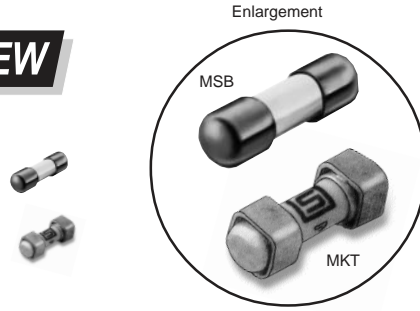

MSB Approvals:
c-UL-us recognition, 2A-6.3A/125V
File #E42088

MKT Approvals pending
UL CSA

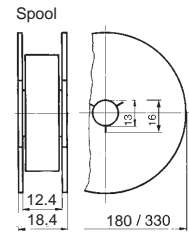
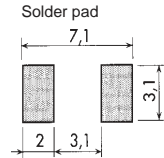
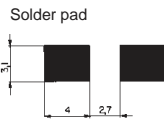
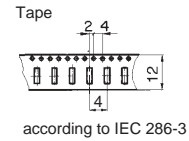
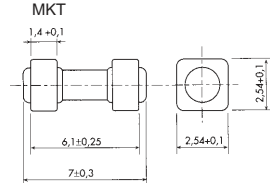
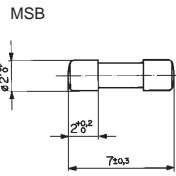
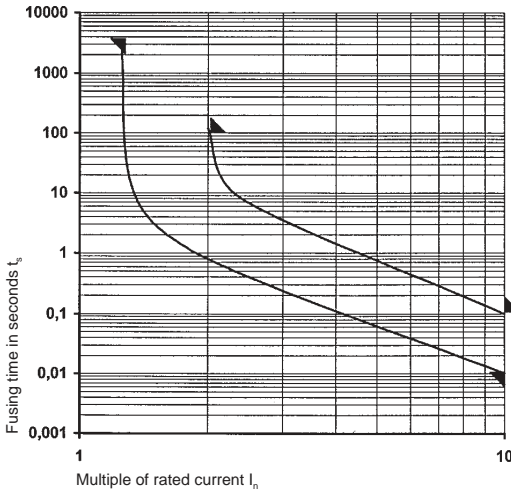

Pre-arcing Time/Current Characteristic (Tamb = 23°C)				
rated current I _n	n • I _n		10 • I	
	1.25 • I _n	2 • I _n	min.	max.
2A - 6.3A	min.	max.	min.	max.
	1 h	120 s	10 ms	100 ms



For information about Melf miniature SMD and through-hole mount fuseholders, see page 87

Technical Data

Rated voltage Un	125 V AC/DC
Rated current	see chart
Time current characteristic	time-lag, see chart for values
Marking	rated current, logo
Ambient temperature max. Tamb	-55°C to +85°C
Solderability (reflow and vapor phase)	235°C / 2 sec. (IEC 68-2-58/Td)
Soldering heat resistance	235°C / 5 sec. (IEC 68-2-58/Td)
Material: Housing	ceramic
End caps	brass, tin-plated
Net weight (per hundred)	MSB 7g MKT 14.5g

Order Numbers	Order Numbers	Rated current / voltage	Breaking Capacity	Voltage drop @ I _n	Sustained Power dissipation @ I _n	Fusing I ^{2t} at 10 • I _n	Packaging		
Series MSB 125V	Series MKT 125V	mA / A / V ~	A ~ ac / dc	max. mV	max. Watts	A2s	Order No. Suffix		
7010.9963.XX	7010.9513.XX	2 A /125V	50A / 125V AC/DC	90	on request	5.1	MSB 125V packaged loose: .XX = .63 1,500 pieces taped & reeled: .XX = .57 5,000 pieces taped & reeled: .XX = .59		
7010.9964.XX	7010.9514.XX	2.5 A /125V	50A / 125V AC/DC	90		8.7			
7010.9965.XX	7010.9515.XX	3.15 A /125V	50A / 125V AC/DC	85		15			
7010.9966.XX	7010.9516.XX	3.5 A /125V	50A / 125V AC/DC	85		19			
7010.9967.XX	7010.9517.XX	4 A /125V	50A / 125V AC/DC	80		27			
7010.9968.XX	7010.9518.XX	5 A /125V	50A / 125V AC/DC	105		30			
7010.9969.XX	7010.9519.XX	6.3 A /125V	63A / 125V AC/DC	85		81			
									MKT 125V packaged loose: .XX = .03 500 pieces taped & reeled: .XX = .55 1,500 pieces taped & reeled: .XX = .57

MSA 125V/250V Quick-acting Miniature Fuse - High Breaking Capacity

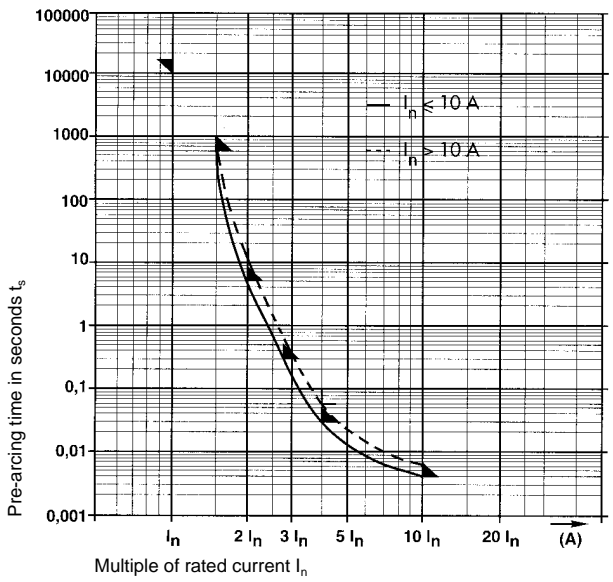

IEC 127-3/2; EN 60127-3/2
UL 248-14 (formerly 198.G)
CSA C22.2 No. 248.14 (formerly 59.2 M)

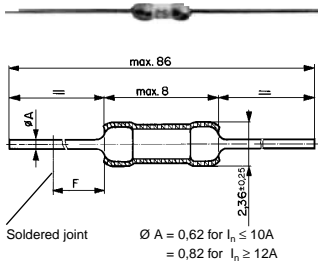

Approvals (series reference 172322)
UL 63mA-15A File #E41599
CSA 63mA-15A File #LR74944

Approvals (series reference 172593; 250V versions)
UL/CSA File # C-UL-US E 42088

L	L1	L2
73 ± 2	85 ± 2	90
53 ± 2	65 ± 2	70
63 ± 2	75 ± 2	80

According to IEC 286-1

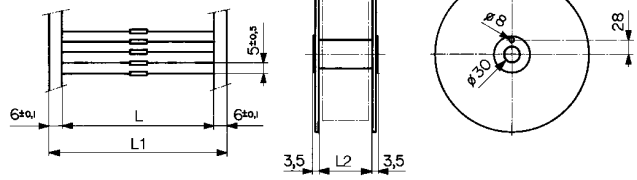

Diameter D of spool: 1500 pcs. = 192 mm; 5000 pcs. = 360 mm

Technical data	
Ambient temperature max. T _a	- 55 °C to + 85 °C
Solderability and soldering conditions acc. to IEC 68-2-20 by thermal shield 1,5 mm thickness	Wave bath: 260°C/10 sec., body Spaced ≥ 3 mm from solder joint F Soldering iron: 350°C/3,5 sec., body Spaced ≥ 6 mm from solder joint F
Materials:	Insulated tube Insulated shroud Caps Terminals Ceramic Hot resistant plastic Brass, tin plated Copper, tin-plated

Pre-arcing time/current characteristic (at T _a 23 °C)								
Rated current I _n	n · I _n	1 · I _n *	1,5 · I _n **	2 · I _n	2,75 · I _n	3 · I _n	4 · I _n	10 · I _n
	min.	max.	max	max.	max.	max.	max.	max.
≤ 10 A	4 h	600 s	5 s	300 ms	30 ms		4 ms	
> 10 A		4 h	600 s	10 s			60 ms	
250 V version	> 4 h			≤ 60 s		≤ 0.1 s		

* Non fusing current I_{nf}

** Only according to UL

Order No. / †	Rated current I _n Rated voltage U _n	Breaking capacity	Voltage drop at I _n		Max. sustained power dissipation at 1,5 I _n		Pre-arcing t _p 10 · I _n	Approvals
			max. IEC 127	max.	max. IEC 127 mW	max. mW		
Loose	Tape and Reel							
0034.4807	0034.4857	63 mA*/ 125 V	2230	1050	154	66.5	0,0008	• •
0034.4810	0034.4860	125 mA*/ 125 V	1500	900	206	115	0,0036	• • •
0034.4813	0034.4863	250 mA*/ 125 V	1000	325	275	82.5	0,0094	• • •
0034.4815	0034.4865	375 mA / 125 V		245		92	0,019	• • •
0034.4817	0034.4867	500 mA*/ 125 V	1000	280	550	130	0,07	• • •
0034.4820	0034.4870	750 mA / 125 V		245		185	0,18	• • •
0034.4822	0034.4872	1 A*/ 125 V	275	210	303	210	0,3	• • •
0034.4824	0034.4874	1.5 A / 125 V		230		345	0,38	• • •
0034.4826	0034.4876	2 A*/ 125 V	250	190	550	380	1,1	• • •
0034.4827	0034.4877	2.5 A*/ 125 V	250	175	668	440	1,4	• • •
0034.4828	0034.4878	3 A / 125 V		170		510	2	• • •
0034.4830	0034.4880	3.5 A / 125 V		160		560	2,6	• • •
0034.4831	0034.4881	4 A*/ 125 V	225	180	990	720	4	• • •
0034.4832	0034.4882	5 A*/ 125 V	225	170	1238	850	6,2	• • •
0034.4833	0034.4883	7 A / 125 V		135		945	13	• • •
0034.4834	0034.4884	10 A / 125 V		130		1300	39	• • •
0034.4835	0034.4885	12 A / 32 V		120		1450	57	• • •
0034.4836	0034.4886	15 A / 32 V		120		1800	90	• • •

Color coded sleeves available on request

* Rated currents of IEC

† for part numbers and ordering data for the 250V version, contact Schurter Inc.

MGL 125V Quick-acting Miniature Fuse



NEW

Approvals:

UL recognition¹⁾ 200mA-3A²⁾ File #E153466
 CSA acceptance 200mA-3A²⁾ File #LR51172
¹⁾ reference series 1020 ²⁾ 4A-5A approvals pending

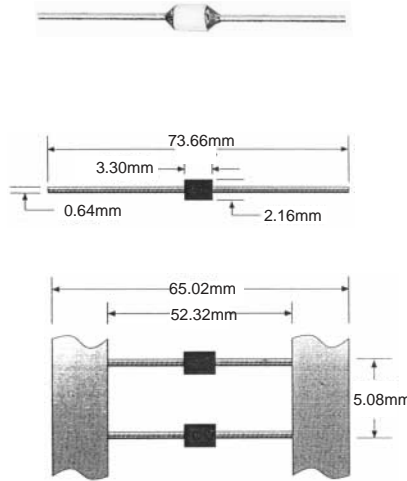
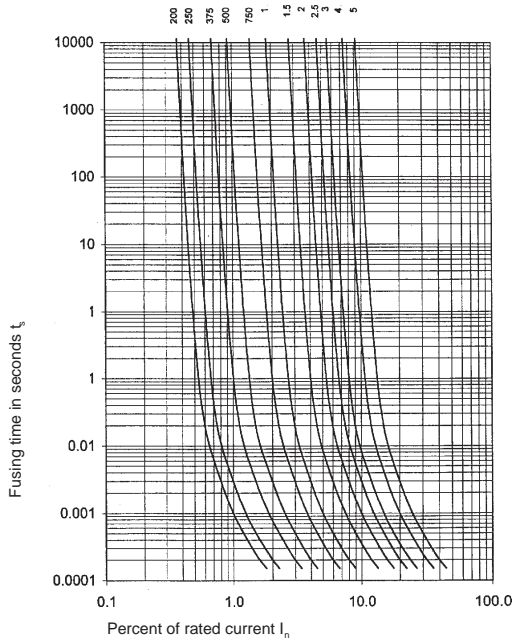

Note: dimensions are in mm

- Mounting holes as close as .2 inch
- Lowest resistance
- Quick-acting
- Hermetically sealed for operating temperatures in excess of 150°C
- Superior cycling

Time Current Characteristics

rated current I_n	$n \cdot I_n$	$2.5 \cdot I_n$
	≥ 4 h	≤ 5 s
200mA – 5A		

Technical Data

Rated current	see chart
Time current characteristic	quick-acting
Breaking capacity	50A AC, 300 A DC
Ambient temperature max.	+150°C
Climatic category	hermetically sealed
Solderability	reflow: 260°C / 30 sec. max; wave: 260°C / 10 sec. max.
Soldering heat resistance	60 seconds above 200°C, max. 260°C
Material: Housing	ceramic
Terminals	copper, nickel-gold plated

Order Numbers	Rated current / voltage	Breaking capacity	Voltage drop at I_n	Resistance at $\leq 10\% I_n$	Pre-arcing I^2t at $4 \cdot I_n$	Packaging
Series MGL 125V	mA / A / V ~	A ~ ac / dc	typical mV	Ohms	A ² s	Order No. Suffix
3411.0021.XX	200 mA / 125V	50 A ac / 300A dc	197	0.87	0.0013	packaged loose: .XX = .05 2,500 pieces taped & reeled: .XX = .06 5,000 pieces taped & reeled: .XX = .07
3411.0022.XX	250 mA / 125V		168	0.63	0.0027	
3411.0025.XX	375 mA / 125V		130	0.32	0.0039	
3411.0027.XX	500 mA / 125V		115	0.20	0.0066	
3411.0029.XX	750 mA / 125V		106	0.11	0.015	
3411.0031.XX	1 A / 125V		119	0.10	0.042	
3411.0033.XX	1.5 A / 125V		106	0.06	0.12	
3411.0035.XX	2 A / 125V		101	0.04	0.20	
3411.0036.XX	2.5 A / 125V		98	0.03	0.35	
3411.0037.XX	3 A / 125V		96	0.02	0.55	
3411.0140.XX	4 A / 32V	94	0.02	0.85		
3411.0141.XX	5 A / 32V	92	0.01	1.0		

All ratings measured at 125V, ambient temperature 25°C +/-3°C. AC with unity power factor; DC with time constant < 1 ms.

MSF 125V Quick-acting Microfuse



IEC 127-3/1; EN 60127-3/1
 UL 248-14 (formerly 198.G)
 CSA C22.2 No. 248.14 (formerly 59.2-M)

NEW

Surge tolerant version for telecom available; see page 163.

Approvals:

UL recognition 100mA – 5A File #E41599
 CSA certification 100mA – 5A File #LR51172
 (transparent cap: file #E67006)

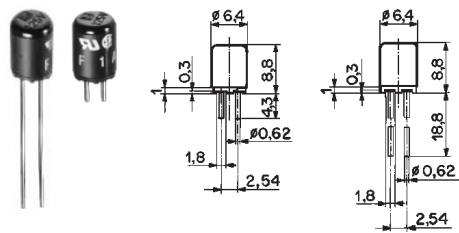
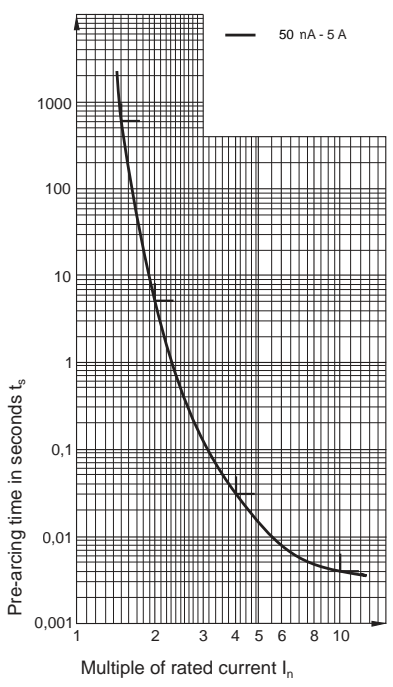

Directly solderable into printed circuit boards or pluggable into fuseholders. Wave solderable and washable in aqueous solutions.

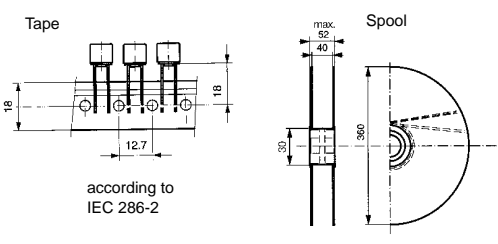

Time current characteristic

$n \cdot I_n$	$1 \cdot I_n$	$1,5 \cdot I_n$	$2,0 \cdot I_n$	$2,75 \cdot I_n$	$4 \cdot I_n$	$10 \cdot I_n$
Rated current I_n	UL/IEC	UL	UL/IEC	IEC	IEC	IEC
0,05 – 5 A	contin.	<10 min.	<5 s	<300 ms	<30 ms	<4 ms



Optional 125V microfuse holder, order number: FMS 0031.7501 (vertical mount) or FMR 0031.7505 (horizontal mount). See page 90 for more information.

Technical data

Ambient temperature max. T_{amb}	- 25 °C to + 85 °C
Capacity at different T_{amb}	1 · I_n up to max. 40 °C 0,9 · I_n up to max. 85 °C
Vibration resistance	Frequency 10 ÷ 2000 Hz, amplitude of 0,75 mm, constant acceleration 100 m/s ² (10 g) acc. to IEC 68-2-6, test Fc
Shock resistance	490 m/s ² (50 g), 11 ms (IEC 68-2-27)
Climate category	HPF according to DIN 40040
Solderability	235 °C / 2 sec. according to IEC 68-2-20, test Ta (DIN 40046)
Soldering heat resistance	260 °C / 10 sec. according to IEC 68-2-20, test Tb (DIN 40046)
Materials	Socket and cap made of temperature resistant plastic (UL 94V-0)
Terminals	Copper tin-plated

Order No., MSF 125 transparent cap	black cap		metal cap***			Rated curr. / rated voltage mA / A / V ~	Breaking capacity A ~	Voltage drop at I_n		Power dissipation at 1 · I_n		Fusing $I^2 t$ t<10ms A ² s	Appr.
	Short leads	Long (A) leads	Short leads	Long (B) leads	Short leads			Long leads	max. IEC 127 mV	typical Schurter mV	max. IEC 127 Watts		
			0034.4707*	0034.4708*			50 mA / 125V	50A/125V AC	800			0.00007	•
0034.4909	0034.6339	0034.4209	0034.4239	0034.4269	0034.4299	100 mA / 125V	IEC: 50A/125V AC/DC p.f. 1 UL/CSA: 300A/125V AC/DC p.f. 1	1000	690	0.11	0.1	0.0007	• •
0034.4910	0034.6340	0034.4210	0034.4240	0034.4270	0034.4300	125 mA / 125V		1000	960	0.14	0.1	0.0015	• •
0034.4911	0034.6341	0034.4211	0034.4241	0034.4271	0034.4301	160 mA / 125V		1000	850	0.18	0.1	0.0036	• •
0034.4912	0034.6342	0034.4212	0034.4242	0034.4272	0034.4302	200 mA / 125V		700	680	0.14	0.1	0.0033	• •
0034.4913	0034.6343	0034.4213	0034.4243	0034.4273	0034.4303	250 mA / 125V		700	620	0.19	0.1	0.0055	• •
0034.4914	0034.6344	0034.4214	0034.4244	0034.4274	0034.4304	315 mA / 125V		700	680	0.24	0.2	0.025	• •
0034.4915	0034.6345	0034.4215	0034.4245	0034.4275	0034.4305	400 mA / 125V		400	180	0.18	0.1	0.013	• •
0034.4916	0034.6346	0034.4216	0034.4246	0034.4276	0034.4306	500 mA / 125V		400	180	0.22	0.1	0.020	• •
0034.4917	0034.6347	0034.4217	0034.4247	0034.4277	0034.4307	630 mA / 125V		400	180	0.28	0.1	0.045	• •
0034.4918**	0034.6348**	0034.4218**	0034.4248**	0034.4278**	0034.4308**	710 mA / 125V		140	70	0.1	0.1	0.045	• •
0034.4919**	0034.6349**	0034.4219**	0034.4249**	0034.4279**	0034.4309**	750 mA / 125V		170	100	0.1	0.1	0.020	• •
0034.4920	0034.6350	0034.4220	0034.4250	0034.4280	0034.4310	800 mA / 125V		400	150	0.37	0.1	0.040	• •
0034.4921	0034.6351	0034.4221	0034.4251	0034.4281	0034.4311	1 A / 125V		190	150	0.21	0.1	0.070	• •
0034.4922	0034.6352	0034.4222	0034.4252	0034.4282	0034.4312	1.25 A / 125V		190	150	0.26	0.2	0.120	• •
0034.4923	0034.6353	0034.4223	0034.4253	0034.4283	0034.4313	1.6 A / 125V		190	150	0.33	0.2	0.290	• •
0034.4924	0034.6354	0034.4224	0034.4254	0034.4284	0034.4314	2 A / 125V		190	130	0.42	0.2	0.430	• •
0034.4925	0034.6355	0034.4225	0034.4255	0034.4285	0034.4315	2.5 A / 125V		190	120	0.52	0.3	0.600	• •
0034.4926	0034.6356	0034.4226	0034.4256	0034.4286	0034.4316	3.15 A / 125V		190	120	0.66	0.4	1.110	• •
0034.4927	0034.6357	0034.4227	0034.4257	0034.4287	0034.4317	4 A / 125V		190	120	0.84	0.5	1.890	• •
0034.4928	0034.6358	0034.4228	0034.4258	0034.4288	0034.4318	5 A / 125V	190	120	1.0	0.6	3.040	• •	

* Deviations
 • Time current characteristics: $I_n > 4h$
 • Permissible continuous operating current; $\leq 0,7 \cdot I_n$
 • Vibration and shock resistance: on request
 • Cap: metal

** Not mentioned in the standards
 *** 1,000 pieces minimum order required for metal cap
 Variable terminal lengths between 3 and 25,4 mm on request

(A) change sixth digit from "3" to "5" for tape and reel part number (e.g. 0034.6539, 1,000 pieces)
 (B) change sixth digit from "2" to "5" for tape and reel part number (e.g. 0034.4539, 1,000 pieces)

MSF 250V Quick Acting Microfuse



IEC 127-3/1; EN 60127-3/1
 UL 248-14 (formerly 198.G)
 CSA C22.2 No. 248-14 (formerly 59.2M)

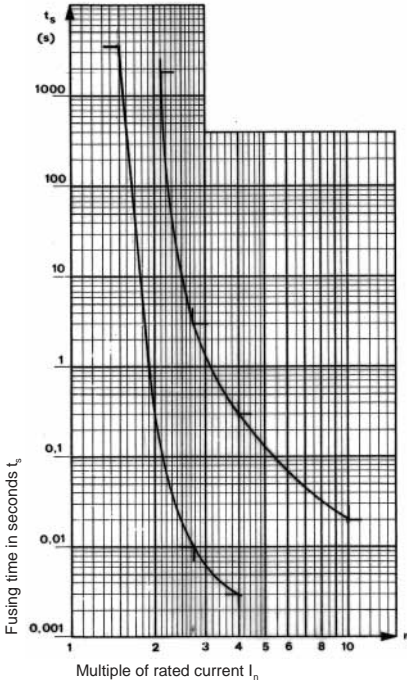

Approvals:

UL	recognition	40mA – 5A	File #E41599
CSA	acceptance	40mA – 5A	File #LR51172
VDE	approval	50mA – 3.15A	File #62460
SEMKO	approval	50mA – 3.15A	} File numbers on request
SEV	approval	50mA – 3.15A	

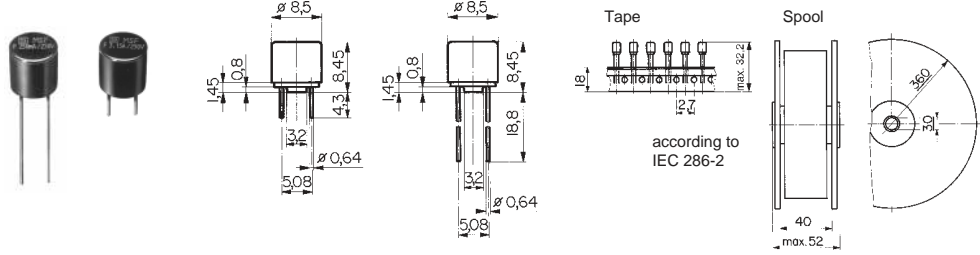

Time Current Characteristics

rated current I _n	1.5 • I _n		2.1 • I _n		2.75 • I _n		4 • I _n		10 • I _n	
	min.	max.	min.	max.	min.	max.	min.	max.	min.	max.
40mA - 5A	60 min.	30 min.	10 ms	3 s	3 ms	300 ms	20 ms			

Optional 250V microfuse holder, order number FMS 0031.7601. See page 90.

Technical Data

Ambient temperature max. T_{amb}	-40°C to +85°C
Capacity at different T_{amb}	1 • I _n up to max. 40°C 0.9 • I _n up to max. 85°C
Vibration resistance	Frequency 10-2000 Hz, cross-over frequency 60 Hz < 60 Hz, constant amplitude 1.5mm > 60 Hz, constant acceleration 100 m/s ² (10g) acc. to IEC 68-2-6 / Fc 490 m/s ² , 11 ms (IEC 68-2-27)
Shock resistance	HPF according to DIN 40040
Climatic category	235°C / 2s according to IEC 68-2-20 / Ta (DIN 40046)
Solderability	260°C / 10s according to IEC 68-2-20 / Tb (DIN 40046)
Soldering heat resistance	Socket and cap made of temperature resistant plastic (UL 94 V-0)
Materials	Copper, tin-plated

Order Numbers Series MSF 250			Rated current / rated voltage mA / A / V ~	Breaking capacity A ~	Voltage drop at I _n		Power dissipation at 1.5 • I _n		Fusing I ² t t _f < 10ms at 10 • I _n A ² s	Approvals				
Short leads black	Long leads black	Taped/reeled-long leads black			max. IEC 127 mV	typical Schurter mV	max. IEC 127 Watts	typical Schurter Watts		UL	CSA	VDE	SEMKO	SEV
0034.6000	0034.6030	0034.6060	40 mA / 250V	35A / 250V AC (p.f. = 1)	850	400								
0034.6001	0034.6031	0034.6061	50 mA / 250V		850	460	0.11	0.1	0.004					
0034.6002	0034.6032	0034.6062	63 mA / 250V		750	330	0.12	0.1	0.001					
0034.6003	0034.6033	0034.6063	80 mA / 250V		650	280	0.14	0.1	0.001					
0034.6004	0034.6034	0034.6064	100 mA / 250V		600	300	0.16	0.1	0.002					
0034.6005	0034.6035	0034.6065	125 mA / 250V		550	210	0.18	0.1	0.006					
0034.6006	0034.6036	0034.6066	160 mA / 250V		500	460	0.21	0.2	0.014					
0034.6007	0034.6037	0034.6067	200 mA / 250V		480	470	0.25	0.2	0.024					
0034.6008	0034.6038	0034.6068	250 mA / 250V		440	360	0.29	0.2	0.058					
0034.6009	0034.6039	0034.6069	315 mA / 250V		400	345	0.33	0.3	0.104					
0034.6010	0034.6040	0034.6070	400 mA / 250V		370	80	0.39	0.1	0.044					
0034.6011	0034.6041	0034.6071	500 mA / 250V		350	75	0.46	0.1	0.090					
0034.6012	0034.6042	0034.6072	630 mA / 250V		320	70	0.53	0.1	0.150					
0034.6013	0034.6043	0034.6073	800 mA / 250V		300	70	0.63	0.1	0.220					
0034.6014	0034.6044	0034.6074	1 A / 250V		280	70	0.74	0.2	0.330					
0034.6015	0034.6045	0034.6075	1.25 A / 250V		280	65	0.92	0.2	0.680					
0034.6016	0034.6046	0034.6076	1.6 A / 250V		250	70	1.0	0.3	0.940					
0034.6017	0034.6047	0034.6077	2 A / 250V		240	70	1.36	0.3	1.330					
0034.6018	0034.6048	0034.6078	2.5 A / 250V		200	65	1.31	0.4	1.940					
0034.6019	0034.6049	0034.6079	3.15 A / 250V		180	65	1.49	0.5	5.400					
0034.6020	0034.6050	0034.6080	4 A / 250V		160	60	1.68	1	7.900					
0034.6021	0034.6051	0034.6081	5 A / 250V	150	60	1.97	1	11.190						

*Not included in the standards

Packaging: Loose, or taped and reeled 750 pcs.

MST 250V Time-lag Microfuse - Low Breaking Capacity



IEC 127-3/1; EN 60127-3/1
 UL 248-14 (formerly 198.G)
 CSA C22.2 No. 248-14 (formerly 59.2M)

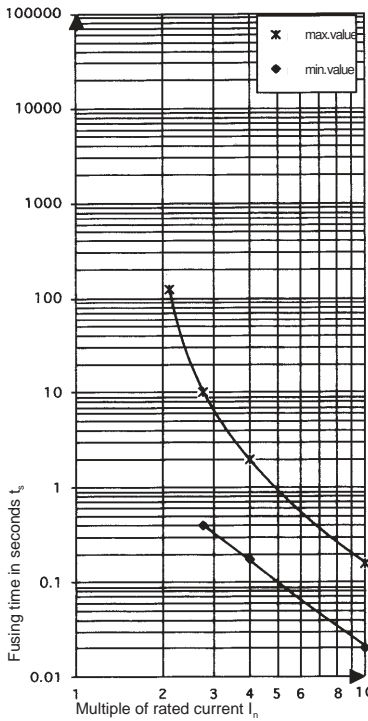

NEW

Surge tolerant version for telecom available; see page 163.

Approvals:

UL recognition	50mA – 6.3A	File #E41599
CSA acceptance	50mA – 6.3A	File #LR51172
VDE approval	50mA – 4A	File #85616
SEMKO approval	50mA – 4A	File numbers on request
SEV approval	50mA – 6.3A	

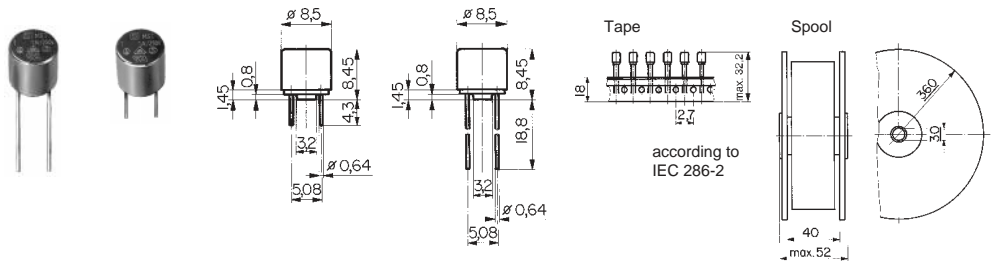

Time Current Characteristics

n • I _n	2.1 • I _n		2.75 • I _n		4 • I _n		10 • I _n	
	max.	min.	max.	min.	max.	min.	max.	
rated current I _n								
continuous	2 min.	400 ms	10 s	150 ms	3 s	20 ms	150 ms	

Optional 250V microfuse holder, order number FMS 0031.7601. See page 90 for more information.

Technical Data

Ambient temperature max. T_{amb}	-40°C to +85°C
Capacity at different T_{amb}	1 x I _n up to max. 40°C 0.9 x I _n up to max. 85°C
Vibration resistance	Frequency 10-2000 Hz, cross-over frequency 60 Hz < 60 Hz, constant amplitude 1.5mm > 60 Hz, constant acceleration at 100 m/s (10g) acc. to IEC 68-2-6 / Fc
Shock resistance	490 m/s ² , 11 ms (IEC 68-2-27)
Climatic category	HPF according to DIN 40040
Solderability	235°C / 2s according to IEC 68-2-20 / Ta (DIN 40046)
Soldering heat resistance	260°C / 10s according to IEC 68-2-20 / Tb (DIN 40046)
Materials	Socket and cap made of temperature resistant plastic (UL 94 V-0)
Terminals	Copper, tin-plated

Order Numbers Series MST			Rated current / rated voltage mA / A / V ~	Breaking capacity A ~	Voltage drop at I _n		Power dissipation at 1.5 • I _n		Fusing I ² t _s < 10ms A ² s	Approvals				
Short leads black	Long leads black	Taped/reeled long leads black			max. IEC 127 mV	typical Schurter mV	max. IEC 127 Watts	typical Schurter Watts		UL	CSA	VDE	SEMKO	SEV
0034.6602	0034.6702	0034.6802	50 mA / 250V	35 A / 250V AC p.f. = 1	550	415	0.15	0.055	0.03	•	•	•	•	•
0034.6603	0034.6703	0034.6803	63 mA / 250V		480	420	0.16	0.07	0.05	•	•	•	•	•
0034.6604	0034.6704	0034.6804	80 mA / 250V		400	360	0.16	0.08	0.07	•	•	•	•	•
0034.6605	0034.6705	0034.6805	100 mA / 250V		350	320	0.17	0.09	0.08	•	•	•	•	•
0034.6606	0034.6706	0034.6806	125 mA / 250V		300	270	0.18	0.09	0.12	•	•	•	•	•
0034.6607	0034.6707	0034.6807	160 mA / 250V		280	190	0.19	0.08	0.24	•	•	•	•	•
0034.6608	0034.6708	0034.6808	200 mA / 250V		260	150	0.20	0.08	0.35	•	•	•	•	•
0034.6609	0034.6709	0034.6809	250 mA / 250V		240	120	0.22	0.08	0.6	•	•	•	•	•
0034.6610	0034.6710	0034.6810	315 mA / 250V		220	120	0.25	0.1	0.8	•	•	•	•	•
0034.6611	0034.6711	0034.6811	400 mA / 250V		200	110	0.28	0.1	1.1	•	•	•	•	•
0034.6612	0034.6712	0034.6812	500 mA / 250V		190	100	0.31	0.1	2.5	•	•	•	•	•
0034.6613	0034.6713	0034.6813	630 mA / 250V		180	90	0.36	0.1	4	•	•	•	•	•
0034.6614	0034.6714	0034.6814	800 mA / 250V		160	80	0.43	0.2	8	•	•	•	•	•
0034.6615	0034.6715	0034.6815	1 A / 250V		140	70	0.5	0.2	12	•	•	•	•	•
0034.6616	0034.6716	0034.6816	1.25 A / 250V		130	70	0.6	0.3	15	•	•	•	•	•
0034.6617	0034.6717	0034.6817	1.6 A / 250V		120	60	0.73	0.3	30	•	•	•	•	•
0034.6618	0034.6718	0034.6818	2 A / 250V		100	60	0.87	0.3	34	•	•	•	•	•
0034.6619	0034.6719	0034.6819	2.5 A / 250V		100	50	1.0	0.4	55	•	•	•	•	•
0034.6620	0034.6720	0034.6820	3.15 A / 250V		100	50	1.2	0.5	76	•	•	•	•	•
0034.6621	0034.6721	0034.6821	4 A / 250V	100	50	1.4	0.6	80	•	•	•	•	•	
0034.6622*	0034.6722*	0034.6822*	5 A / 250V	60	60	1.9	0.9	230	•	•	•	•	•	
0034.6623*	0034.6723*	0034.6823*	6.3 A / 250V	50	50	2.5	1.1	360	•	•	•	•	•	

* Built according to manufacturer's specifications. Not mentioned in IEC standards.

Packaging: Loose, or taped and reeled 750 pcs.

MST-U 250V Time-lag Microfuse



UL 248-14 (formerly 198.G)

Approvals:

UL listing 50mA – 6.3A File #E41599
 CSA acceptance 50mA – 6.3A File #LR51172-34

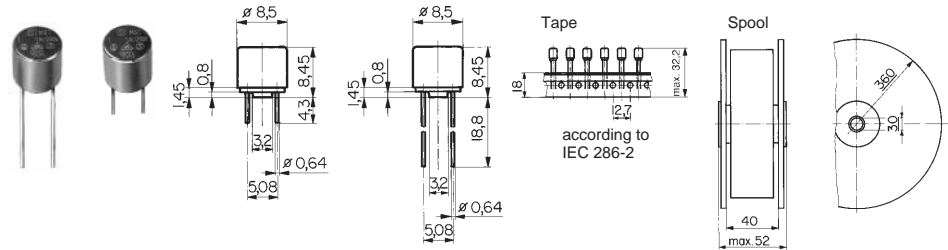
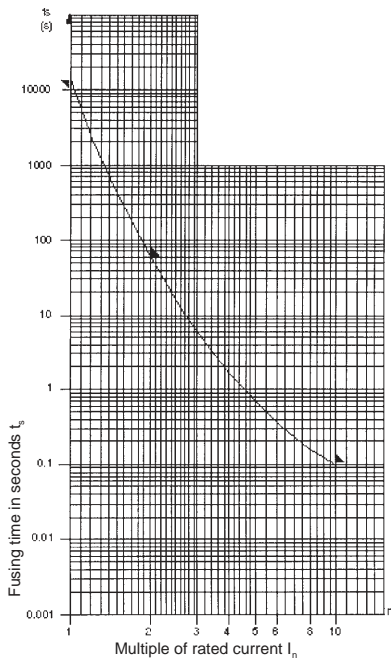

Time Current Characteristics

rated current I_n	$n \cdot I_n$	$1 \cdot I_n$	$2 \cdot I_n$
		max.	max.
50 mA - 6.3 A		> 4h	< 60s



Optional 250V microfuse holder, order number FMS 0031.7601. See page 90 for more information.

Technical Data

Ambient temperature max. T_{amb}	-40°C to +85°C
Capacity at different T_{amb}	1 • I_n up to max. 40°C 0.9 • I_n up to max. 85°C
Vibration resistance	Frequency 10-2000 Hz, cross-over frequency 60 Hz < 60 Hz, constant amplitude 1.5mm > 60 Hz, constant acceleration at 100 m/s ² (10g) acc. to IEC 68-2-6 / Fc
Shock resistance	490 m/s ² , 11 ms (IEC 68-2-27)
Climatic category	HPF according to DIN 40040
Solderability	235°C / 2s according to IEC 68-2-20 / Ta (DIN 40046)
Soldering heat resistance	260°C / 10s according to IEC 68-2-20 / Tb (DIN 40046)
Materials	Socket and cap made of temperature resistant plastic (UL 94 V-0)
Terminals	Copper, tin-plated

Order Numbers Series MST-U			Rated current / rated voltage mA / A / V ~	Breaking capacity A ~	Voltage drop at I_n typical Schurter mV	Power dissipation at $1 \times I_n$ typical Schurter mW	Pre-arcing $I^2 t$ at $10 \times I_n$ A_2 s	Approvals	
Short leads black	Long leads black	Taped/reeled long leads black						UL	CSA
0034.7102	0034.7202	0034.7302	50 mA / 250V	50 A / 250V AC (p.f. = 1)	205	54	0.23	•	•
0034.7103	0034.7203	0034.7303	63 mA / 250V					•	•
0034.7104	0034.7204	0034.7304	80 mA / 250V					•	•
0034.7105	0034.7205	0034.7305	100 mA / 250V					•	•
0034.7106	0034.7206	0034.7306	125 mA / 250V					•	•
0034.7107	0034.7207	0034.7307	160 mA / 250V					•	•
0034.7108	0034.7208	0034.7308	200 mA / 250V					•	•
0034.7109	0034.7209	0034.7309	250 mA / 250V					•	•
0034.7110	0034.7210	0034.7310	315 mA / 250V					•	•
0034.7111	0034.7211	0034.7311	400 mA / 250V					•	•
0034.7112	0034.7212	0034.7312	500 mA / 250V	•	•				
0034.7113	0034.7213	0034.7313	630 mA / 250V	•	•				
0034.7114	0034.7214	0034.7314	800 mA / 250V	•	•				
0034.7115	0034.7215	0034.7315	1 A / 250V	100	107	6.44	•	•	
0034.7116	0034.7216	0034.7316	1.25 A / 250V				•	•	
0034.7117	0034.7217	0034.7317	1.6 A / 250V				•	•	
0034.7118	0034.7218	0034.7318	2 A / 250V				•	•	
0034.7119	0034.7219	0034.7319	2.5 A / 250V				•	•	
0034.7120	0034.7220	0034.7320	3.15 A / 250V				•	•	
0034.7121	0034.7221	0034.7321	4 A / 250V				•	•	
0034.7122	0034.7222	0034.7322	5 A / 250V				•	•	
0034.7123	0034.7223	0034.7323	6.3 A / 250V				•	•	
							73	241	53
				68	490	262	•	•	

Packaging: Loose, or taped and reeled 750 pcs.

FOLDOUT PAGE 141

MXT 250V Time-lag Microfuse - High Breaking Capacity



IEC 127-3/4; EN 60127-3/4 however with a higher breaking capacity
 UL 248-14 (formerly 198G)
 CSA C22.2 No. 248.14 (formerly 59.2M)

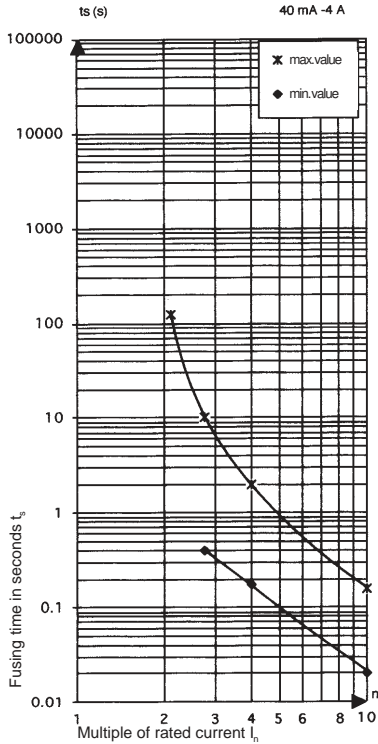

Approvals:

UL recognition	800mA – 6.3A	File #E41599
CSA acceptance	800mA – 6.3A	File #LR51172
VDE approval	800mA – 4A	File #77566
SEMKO approval	800mA – 4A	} File numbers on request
SEV approval	800mA – 6.3A	

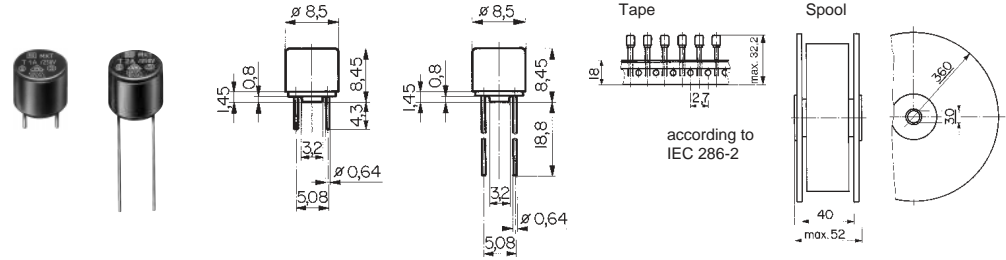

Time Current Characteristics

n • In	2.1 • In		2.75 • In		4 • In		10 • In	
	max.	min.	max.	min.	max.	min.	max.	
rated current In								
continuous	2 min.	400 ms	10 s	150 ms	3 s	20 ms	150 ms	

 Optional 250V microfuse holder,
 order number FMS 0031.7601.
 See page 90 for more information.

Technical Data

Ambient temperature max. T_{amb}	-25°C to +85°C
Capacity at different T_{amb}	1 • I _n up to max. 40°C 0.9 • I _n up to max. 85°C
Vibration resistance	Frequency 10-2000 Hz, cross-over frequency 40 Hz < 60 Hz, constant amplitude 1.5mm > 60 Hz, constant acceleration 100 m/s ² (10g) acc. to IEC 68-2-6 / Fc
Shock resistance	490 m/s ² , 11 ms (IEC 68-2-27)
Climatic category	HPF according to DIN 40040
Solderability	235°C / 2s according to IEC 68-2-20 / Ta (DIN 40046)
Soldering heat resistance	260°C / 10s according to IEC 68-2-20 / Tb (DIN 40046)
Materials	Socket and cap made of temperature resistant plastic (UL 94 V-0)
Terminals	Copper, tin-plated

Order Numbers Series MXT			Rated current / rated voltage mA/A/V~	Breaking capacity A~	Voltage drop at In		Power dissipation at 1.5 • In		Fusing I ² t at 10 • I _n A ² S	Approvals				
Short leads black	Long leads black	Taped/reeled long leads black			max. IEC 127-3 mV	typical Schurter mV	max. IEC 127-3 Watts	typical Schurter Watts		UL	CSA	VDE	SEMKO	SEV
0034.6914	0034.6944	0034.6974	800 mA / 250V		160	150	0.43	0.3	2.2	•	•	•	•	•
0034.6915	0034.6945	0034.6975	1 A / 250V		140	130	0.5	0.35	4.4	•	•	•	•	•
0034.6916	0034.6946	0034.6976	1.25 A / 250V	100A	130	120	0.6	0.4	6.3	•	•	•	•	•
0034.6917	0034.6947	0034.6977	1.6 A / 250V	250V / AC	120	110	0.73	0.5	10	•	•	•	•	•
0034.6918	0034.6948	0034.6978	2 A / 250V	(p.f. = 1)	100	85	0.87	0.5	16	•	•	•	•	•
0034.6919	0034.6949	0034.6979	2.5 A / 250V	acc. to IEC	100	85	1	0.65	32	•	•	•	•	•
0034.6920	0034.6950	0034.6980	3.15 A / 250V	IEC	100	75	1.2	0.67	57	•	•	•	•	•
0034.6921	0034.6951	0034.6981	4 A / 250V	127-3/4	100	75	1.4	0.9	77	•	•	•	•	•
0034.6922*	0034.6952*	0034.6982*	5 A / 250V		70	70		1.1	155	•	•	•	•	•
0034.6923*	0034.6953*	0034.6983*	6.3 A / 250V		65	65		1.15	262	•	•	•	•	•

* Built according to manufacturer's specifications. Not mentioned in IEC standards.

Packaging: Loose, or taped and reeled 750 pcs.

FRT 250 F Quick-acting; FRT 250 T Time-lag, Fuse with Radial Leads

IEC 127-4/1

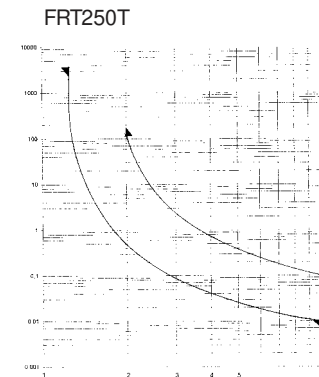
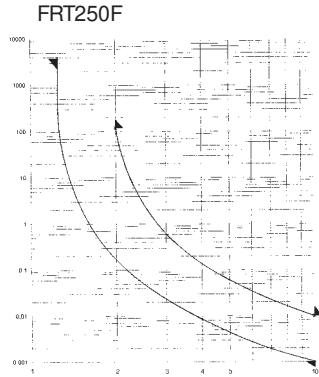

NEW

Surge tolerant version for telecom available; see page 164

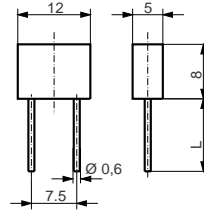
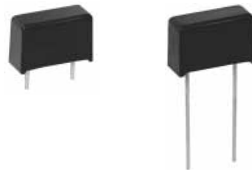

L: short ± 4.3 mm
long ± 19 mm
 $\varnothing = 0.6$ mm
directly solderable into printed circuit boards or pluggable into fuseholders

Approvals:

- UL listing pending
- CSA certification pending

Tape

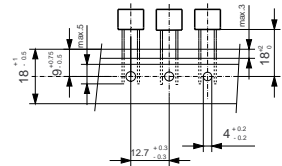

Reel

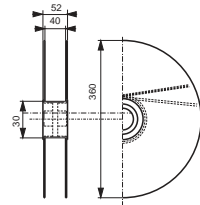

Pre-arcing time/current
Characteristic temps (at T_a 23 °C)

Rated current I_n	$n \cdot I_n$		$10 \cdot I_n$	
	min.	max.	min.	max.
FRT250F 250 mA–6.3A	60 min.	120 s	1 ms	10 ms
FRT250T 250 mA–6.3A	60 min.	120 s	10 ms	100 ms

* Non fusing current I_{nf}

Tape and reel according to IEC 286-2

Technical data

Ambient temperature max. T_a	-40°C to +85°C
Capacity at different T_a	1 · I_n up to max. 40°C 0,9 · I_n up to max. 85°C
Resistance to vibration	Frequency 10 ÷ 2000Hz, cross-over frequency 60 Hz < 60 Hz constant amplitude of 1,5 mm > 60 Hz constant acceleration of 100m/s ² (10g) according to IEC 68-2-6, test Fc
Resistance to shock	490 m/s ² (50g), 11 ms according to IEC 68-2-27
Climate category	according to DIN 40040
Solderability	235°C / 2 sec. according to IEC 68-2-20, test Ta
Soldering heat resistance	260°C / 10 sec. according to IEC 68-2-20, test Tb
Materials	Socket and cap temperature resistant plastic, UL 94V-0 Terminals Copper tin-plated

FRT 250 F				FRT 250 T				FRT 250 T				FRT 250 T							
Order No., Quick-acting				Order No., Time-lag				Order No., Time-lag				Order No., Time-lag							
Terminals		Rated current I_n	Rated voltage U_n	Breaking Capacity	Voltage drop		Max. sustained power diss.	Pre-arcing I^2t	Terminals		Rated current I_n	Rated voltage U_n	Breaking Capacity	Voltage drop		Max. sustained power diss.	Pre-arcing I^2t		
short	long				max.	typ			max.	typ				short	long			max.	typ
7100.1059.XX	7100.1159.XX	250 mA / 250V	250V	100A / 250V	800	460	500	300	0.019	7100.1009.XX	7100.1109.XX	250 mA / 250V	250V	100A / 250V	800	170	500	150	0.032
7100.1060.XX	7100.1160.XX	315 mA / 250V	250V	100A / 250V	750	160	500	150	0.028	7100.1010.XX	7100.1110.XX	315 mA / 250V	250V	100A / 250V	750	160	500	200	0.05
7100.1061.XX	7100.1161.XX	400 mA / 250V	250V	100A / 250V	700	140	500	150	0.040	7100.1011.XX	7100.1111.XX	400 mA / 250V	250V	100A / 250V	700	135	500	200	0.08
7100.1062.XX	7100.1162.XX	500 mA / 250V	250V	100A / 250V	600	125	500	200	0.060	7100.1012.XX	7100.1112.XX	500 mA / 250V	250V	100A / 250V	600	125	500	200	1.25
7100.1063.XX	7100.1163.XX	630 mA / 250V	250V	100A / 250V	500	180	500	250	0.075	7100.1013.XX	7100.1113.XX	630 mA / 250V	250V	100A / 250V	500	130	500	200	2
7100.1064.XX	7100.1164.XX	800 mA / 250V	250V	100A / 250V	400	170	500	300	0.135	7100.1014.XX	7100.1114.XX	800 mA / 250V	250V	100A / 250V	400	200	500	300	3.2
7100.1065.XX	7100.1165.XX	1 A / 250V	250V	100A / 250V	300	160	500	300	0.200	7100.1015.XX	7100.1115.XX	1 A / 250V	250V	100A / 250V	300	180	500	400	5
7100.1066.XX	7100.1166.XX	1.25 A / 250V	250V	100A / 250V	300	140	1000	300	0.320	7100.1016.XX	7100.1116.XX	1.25 A / 250V	250V	100A / 250V	300	145	1000	400	7.9
7100.1067.XX	7100.1167.XX	1.6 A / 250V	250V	100A / 250V	300	140	1000	400	0.600	7100.1017.XX	7100.1117.XX	1.6 A / 250V	250V	100A / 250V	300	110	1000	400	12.8
7100.1068.XX	7100.1168.XX	2 A / 250V	250V	100A / 250V	300	130	—	500	1.1	7100.1018.XX	7100.1118.XX	2 A / 250V	250V	100A / 250V	300	105	—	400	20
7100.1069.XX	7100.1169.XX	2.5 A / 250V	250V	100A / 250V	300	125	1000	500	1.9	7100.1019.XX	7100.1119.XX	2.5 A / 250V	250V	100A / 250V	300	140	1000	700	32
7100.1070.XX	7100.1170.XX	3.15 A / 250V	250V	100A / 250V	300	120	1200	650	3.3	7100.1020.XX	7100.1120.XX	3.15 A / 250V	250V	100A / 250V	300	115	1200	700	50
7100.1071.XX	7100.1171.XX	4 A / 250V	250V	100A / 250V	300	120	1500	900	5.9	7100.1021.XX	7100.1121.XX	4 A / 250V	250V	100A / 250V	300	120	1500	900	80
7100.1072.XX	7100.1172.XX	5 A / 250V	250V	100A / 250V	300	125	1875	1200	11	7100.1022.XX	7100.1122.XX	5 A / 250V	250V	100A / 250V	300	125	1875	1200	125
7100.1073.XX	7100.1173.XX	6.3 A / 250V	250V	100A / 250V	300	130	—	1600	18	7100.1023.XX	7100.1123.XX	6.3 A / 250V	250V	100A / 250V	300	120	—	1400	200

XX = Packaging index

Packaging

Loose	7100.XXXX.13
Tape and reeled 500 pieces	7100.XXXX.95
Tape and reeled 1000 pieces	7100.XXXX.96

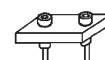

Suitable fuseholder on request

SA 5 x 20mm Super Quick-acting Fuses – High Breaking Capacity



Built according to SEMKO 104-1976

Approvals:
SEMKO approval 1.6A-6.3A File #8738128

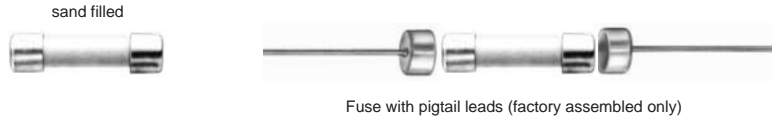
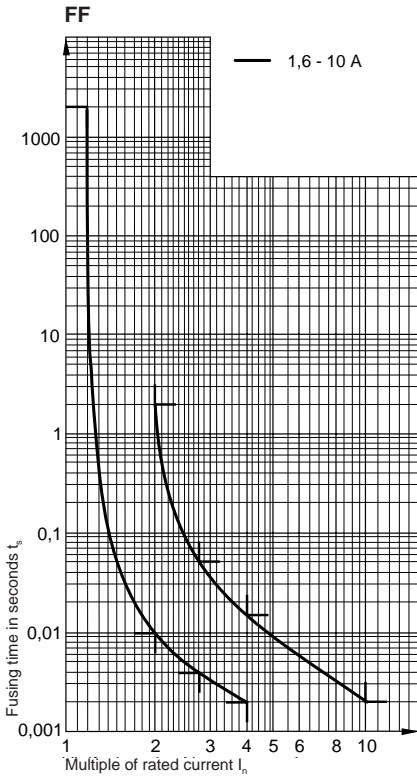

Time Current Characteristics

n • I _n rated current I _n	1.2 • I _n		2 • I _n		2.75 • I _n		4 • I _n		10 • I _n
	min.	max.	min.	max.	min.	max.	min.	max.	max.
1.6A – 10A	60min.	10ms	2s	4ms	50ms	2ms	15ms	2ms	

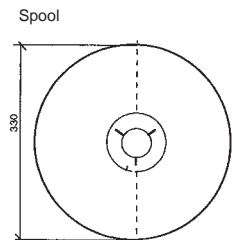
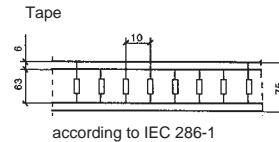
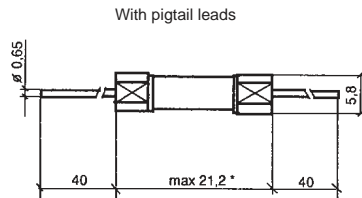
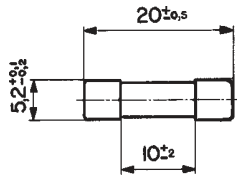

Order Numbers	Rated current / rated voltage	Breaking capacity	Voltage drop at I _n		Power dissipation at 1.2 • I _n		Operating I ² t	Approvals
			max. Schurter mV	typical Schurter mV	max. Schurter Watts	typical Schurter Watts		
Series SA	A / V~	A~					A ² s	SEMCO
0034.0903	1.6 A / 250V	1500A at 250 V, 50 Hz p.f. 0.7 - 0.8	400	250	1.0	0.6	1.8	•
0034.0904	2 A / 250V		370	200	1.1	0.6	4.2	•
0034.0905	2.5 A / 250V		340	200	1.3	0.8	6.6	•
0034.0906	3.15 A / 250V		310	180	1.5	1.0	8.2	•
0034.0907	4 A / 250V		280	180	1.7	1.2	19	•
0034.0908	5 A / 250V		250	160	1.9	1.4	20	•
0034.0909	6.3 A / 250V		250	170	2.3	2.0	23	•
0034.0910	8 A / 250V		250	190	3.0	2.8	32	•
0034.0911	10 A / 250V		250	160	3.7	2.9	43	•

For protection of semiconductors, ask for special catalog (reference super quick-acting fuse series D GLD II / III 0034.1101 - .1115, 2A-6A/500V)

For pigtail fuses packaged loose: reference .PT after part number (e.g. 0034.0903.PT)
For pigtail fuses on 1,000-piece tape and reel: reference .TR after part number (e.g. 0034.0903.TR)

SP 5 x 20mm Quick-acting Fuses – High Breaking Capacity



Built according to IEC 127-2/1, EN 60127, SEV 1064, DIN/VDE 0820 part 1, DIN 41660, BS 4265, and SEMKO 104-1976. Recommended if the short circuit current through the fuse-link is more than 35A or 10 x I_n, whichever is greater (CENELEC Jan 1, 1993).

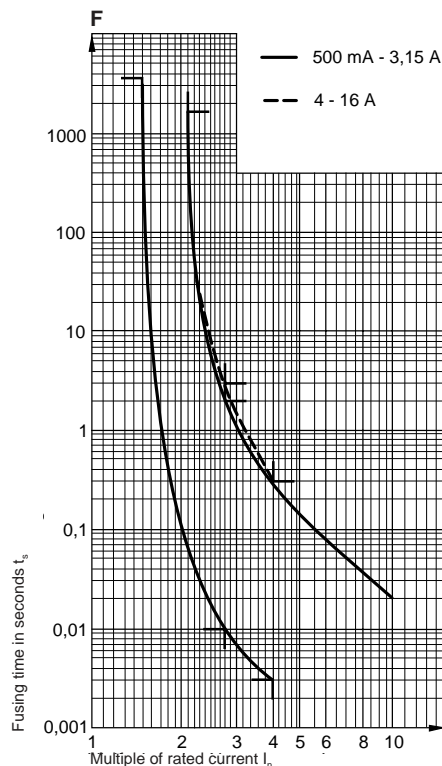

Approvals:

UL	recognition	500mA-16A*	File #E41599 File #LR51172 File #51959 File numbers on request
CSA	acceptance	500mA-16A*	
VDE	approval	500mA-6.3A	
SEMKO	approval	500mA-6.3A	
SEV	approval	500mA-6.3A	
CB	certified	800mA-1.6A, 2.5A, 5A	

* fuses with pigtail leads approved up to 8A (factory assembled only)



Time Current Characteristics

rated current I _n	1.5 • I _n		2.1 • I _n		2.75 • I _n		4 • I _n		10 • I _n
	min.	max.	min.	max.	min.	max.	min.	max.	
500mA – 16A	60 min.	30 min.	10 ms	2 s*	3 ms	300ms	20 ms		

* 1.25A – 16A max. 3 s

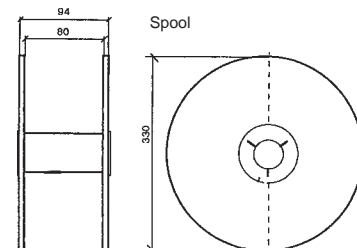
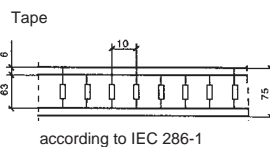
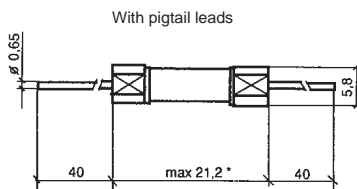
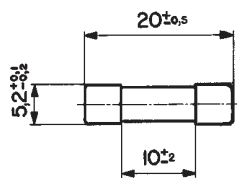

Order Numbers	Rated current / rated voltage	Breaking capacity	Voltage drop at I _n		Power dissipation at 1.5 • I _n		Operating I ² t	Approvals						
			max. IEC 127 mV	typical Schurter mV	max. IEC 127 Watts	typical Schurter Watts		UL	CSA	VDE	SEMKO	SEV	CB	
Series SP	mA / A / V~	A~ ac					A ² s							
0001.1001	500 mA / 250V	UL: 10,000A / 125 V, p.f. 0.7 - 0.8 IEC / UL: 1,500A / 250 V, p.f. 0.7 - 0.8	1800	830	2.5	2.4	0.08	•	•	•	•	•	•	
0001.1002	630 mA / 250V		1500	800	2.5	2.4	0.22	•	•	•	•	•	•	
0001.1003	800 mA / 250V		1200	580	2.5	2.4	0.47	•	•	•	•	•	•	
0001.1004	1 A / 250V		1000	600	2.5	2.5	0.84	•	•	•	•	•	•	
0001.1005	1.25 A / 250V		800	270	4	1.0	0.92	•	•	•	•	•	•	
0001.1006	1.6 A / 250V		600	350	4	1.6	0.94	•	•	•	•	•	•	
0001.1007	2 A / 250V		500	260	4	1.6	2.7	•	•	•	•	•	•	
0001.1008	2.5 A / 250V		400	260	4	1.9	4.0	•	•	•	•	•	•	
0001.1009	3.15 A / 250V		350	210	4	1.9	8.3	•	•	•	•	•	•	
0001.1010	4 A / 250V		300	200	4	2.4	14	•	•	•	•	•	•	
0001.1011	5 A / 250V		250	160	4	2.4	37	•	•	•	•	•	•	
0001.1012	6.3 A / 250V		200	150	4	3.2	42	•	•	•	•	•	•	
0001.1013	8 A* / 250V			140		3.9	100	•	•	•	•	•	•	
0001.1014	10 A* / 250V			130		4.7	167	•	•	•	•	•	•	
0001.1015	12.5 A* / 250V		1,000A / 125V, p.f. 1.0	110		6.9	286	•	•	•	•	•	•	
0001.1016	16 A* / 250V		500A / 125V, p.f. 0.7 - 0.8	120		7.4	504	•	•	•	•	•	•	

* Not addressed in the standards

For pigtail fuses packaged loose: reference .PT after part number (e.g. 0001.1001.PT)

For pigtail fuses on 1,000-piece tape and reel: reference .TR after part number (e.g. 0001.1001.TR)

FSF 5 x 20mm Quick-acting Fuses – Low Breaking Capacity



Built according to IEC 127-2/2, EN 60127, ASE 1064, DIN/VDE 0820 part 1, DIN 41661, BS 4265, and SEMKO 104-1976. Series SP & SPT recommended if the short circuit current through the fuse-link is more than 35A or $10 \times I_n$, whichever is greater (CENELEC Jan 1, 1993).

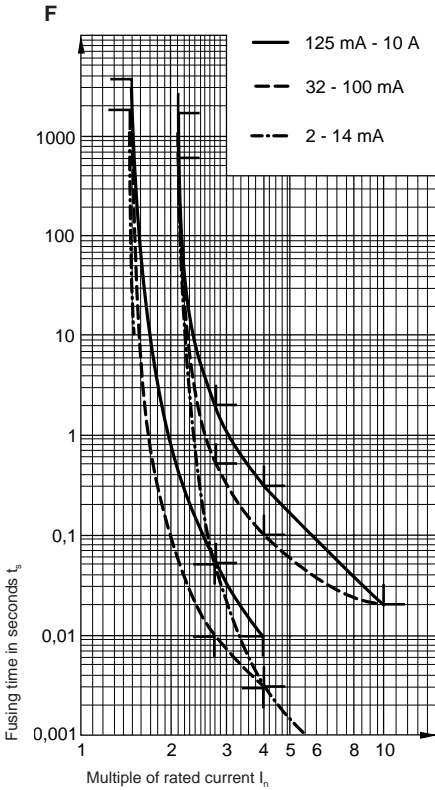

Approvals:

UL	recognition	32mA-10A*	File #E41599
CSA	acceptance	32mA-10A*	File #LR51172
VDE	approval	32mA-6.3A	File #50911
SEMKO	approval	32mA-6.3A	} File numbers on request
SEV	approval	32mA-6.3A	
BEAB	approval	32mA-6.3A	

* fuses with pigtail leads approved up to 8A (factory assembled only)



Time Current Characteristics

rated current I_n	$n \cdot I_n$		$2.75 \cdot I_n$		$4 \cdot I_n$		$10 \cdot I_n$
	min.	max.	min.	max.	min.	max.	max.
2mA – 14mA	~ 30 min.	~ 10min.*		= 10 min. ~ 50 ms		~ 3 ms	~ 0.3 ms
32mA – 100mA	60 min.	30 min.	10 ms	500 ms	3 ms	100 ms	20 ms
125mA – 10A	60 min.	30 min.	50 ms	2 s	10 ms	300 ms	20 ms

* This value is not guaranteed for DC

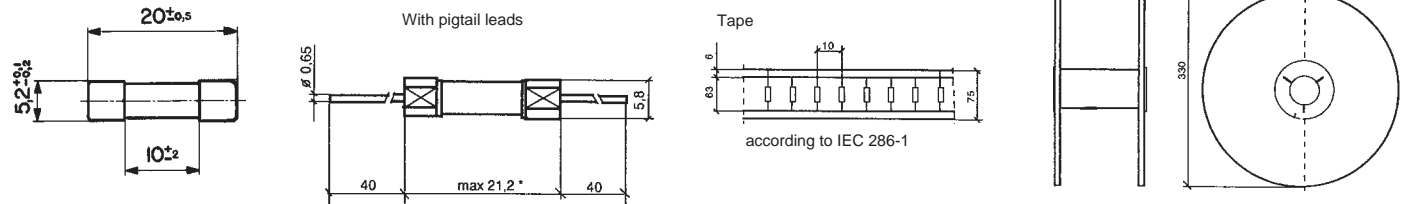

Order Numbers	Rated current / rated voltage	Breaking capacity	Voltage drop at I_n		Power dissipation at $1.5 \cdot I_n$		Operating I^2t	Approvals							
			max. IEC 127 mV	typical Schurter mV	max. IEC 127 Watts	typical Schurter Watts		JUL	CSA	VDE	SEMKO	SEV	BEAB		
Series FSF	mA / A / V~	A~					A ² s								
0034.1501	2 mA* / 250V	35A / 250 V / 50 Hz / p.f. 1	10000	1600			0.000009								
0034.1502	4 mA* / 250V			540			0.00001								
0034.1503	7 mA* / 250V			640			0.00002								
0034.1504	10 mA* / 250V			500			0.00002								
0034.1505	14 mA* / 250V			380			0.00003								
0034.1527	32 mA / 250V				9300	1.6	0.7	0.00006							
0034.1528	40 mA / 250V				8000	1.6	0.7	0.00013							
0034.1529	50 mA / 250V				7000	6400	1.6	0.7	0.00024						
0034.1530	63 mA / 250V				5000	940	1.6	0.3	0.00054						
0034.1531	80 mA / 250V				4000	750	1.6	0.3	0.0016						
0034.1506	100 mA / 250V				3500	840	1.6	0.4	0.0023						
0034.1507	125 mA / 250V				2000	610	1.6	0.4	0.0067						
0034.1508	160 mA / 250V				2000	550	1.6	0.5	0.018						
0034.1509	200 mA / 250V				1700	540	1.6	0.5	0.03						
0034.1510	250 mA / 250V				1400	240	1.6	0.2	0.021						
0034.1511	315 mA / 250V				1300	210	1.6	0.2	0.044						
0034.1512	400 mA / 250V				1200	200	1.6	0.2	0.088						
0034.1513	500 mA / 250V				1000	150	1.6	0.2	0.15						
0034.1514	630 mA / 250V				650	140	1.6	0.3	0.37						
0034.1515	800 mA / 250V				240	110	1.6	0.3	5.3						
0034.1516	1 A / 250V				200	110	1.6	0.3	5.1						
0034.1517	1.25 A / 250V				200	100	1.6	0.4	5.6						
0034.1518	1.6 A / 250V				190	100	1.6	0.5	6.5						
0034.1519	2 A / 250V				170	90	1.6	0.6	7.6						
0034.1520	2.5 A / 250V				170	90	1.6	0.8	9.8						
0034.1521	3.15 A / 250V				150	90	2.5	0.6	20						
0034.1522	4 A / 250V		130	90	2.5	1.0	29								
0034.1523	5 A / 250V	10 • I _n 250V / 50 Hz / p.f. 1	130	80	2.5	1.3	38								
0034.1524	6.3 A / 250V		130	80	2.5	2.0	62								
0034.1525	8 A* / 250V		80	80		2.3	103								
0034.1526	10 A* / 250V		70	70		2.5	184								

*Not addressed in the standards

For pigtail fuses packaged loose: reference .PT after part number (e.g. 0034.1501.PT)

For pigtail fuses on 1,000-piece tape and reel: reference .TR after part number (e.g. 0034.1501.TR)

FSM 5 x 20mm Medium Time Lag Fuses – Low and Medium Breaking Capacity

Built according to DIN 41571, data sheet 2 (June 1984)

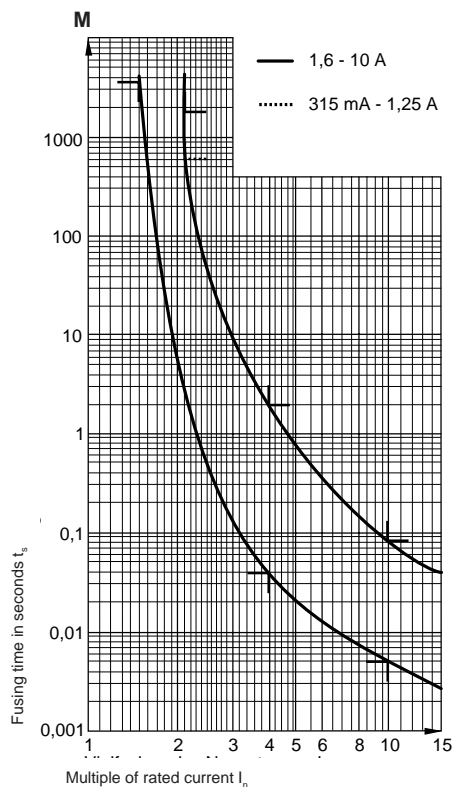

Glass tube



0034.2511 - .2517

Ceramic tube
Sand filled



0034.2518 - .2527



Fuse with pigtail leads (factory assembled only)

Time Current Characteristics

n • I _n rated current I _n	1.5 • I _n		2.1 • I _n		4 • I _n		10 • I _n	
	min.	max.	min.	max.	min.	max.	min.	max.
315mA – 1.25A	60 min.	10 min.	40 ms	2 s	5 ms	90 ms		
1.6A – 10A	60 min.	30 min.	40 ms	2 s	5 ms	90 ms		

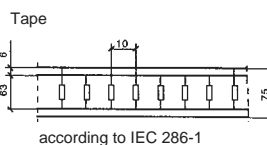
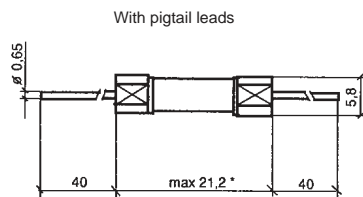
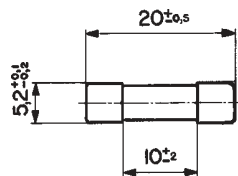

according to IEC 286-1

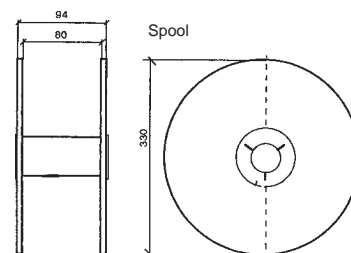

Order Numbers Series FSM	Rated current / rated voltage mA / A / V~	Breaking capacity C, E, D p.f. 1 G p.f. 0.7-0.8 A~	Voltage drop at I _n		Power dissipation at 1.5 • I _n		Operating I ² t A ² s	
			max. DIN 41571 mV	typical Schurter mV	max. Schurter Watts	typical Schurter Watts		
0034.2511	315 mA / 250V	80A / 125V- C 80A / 250V~ C	250	200	0.4	0.2	0.33	
0034.2512	400 mA / 250V		230	160	0.4	0.2	0.41	
0034.2513	500 mA / 250V		210	140	0.4	0.2	1.5	
0034.2514	630 mA / 250V		190	140	0.4	0.2	12	
0034.2515	800 mA / 250V		170	130	0.4	0.2	11	
0034.2516	1 A / 250V		160	70	0.4	0.2	15	
0034.2517	1.25 A / 250V		160	70	0.6	0.2	23	
0034.2518	1.6 A / 250V		1000A / E 125V- E	160	150	0.8	0.6	3.5
0034.2519	2 A / 250V		160	140	0.9	0.7	5.0	
0034.2520	2.5 A / 250V		160	130	1.0	0.8	13	
0034.2521	3.15 A / 250V	1000A / E 250V~ E	160	120	1.2	1.0	21	
0034.2522	4 A / 250V	160	120	1.5	1.3	37		
0034.2523	5 A / 250V	150	100	1.7	1.4	95		
0034.2524	6.3 A / 250V	300A / 125V- D 300A / 250V~ D	140	100	2.0	1.7	165	
0034.2525	8 A / 250V	140	90	2.6	2.3	240		
0034.2526	10 A / 250V	120	80	2.8	2.3	455		
0034.2527	10 A* / 250V	1500A / G 250V~ G	120	80	2.8	2.5	255	

*Not mentioned in DIN 41571. Check temperature rise if fuses are used in closed type fuseholders.

For pigtail fuses packaged loose: reference .PT after part number (e.g. 0034.2511.PT)
 For pigtail fuses on 1,000-piece tape and reel: reference .TR after part number (e.g. 0034.2511.TR)

SPT 5 x 20mm Time Lag Fuses – High Breaking Capacity



Built according to IEC 127-2/5, EN 60127, SEV 1064, and SEMKO 104-1976. Recommended if the short circuit current through the fuse-link is more than 35A or $10 \times I_n$, whichever is greater (CENELEC Jan 1, 1993).

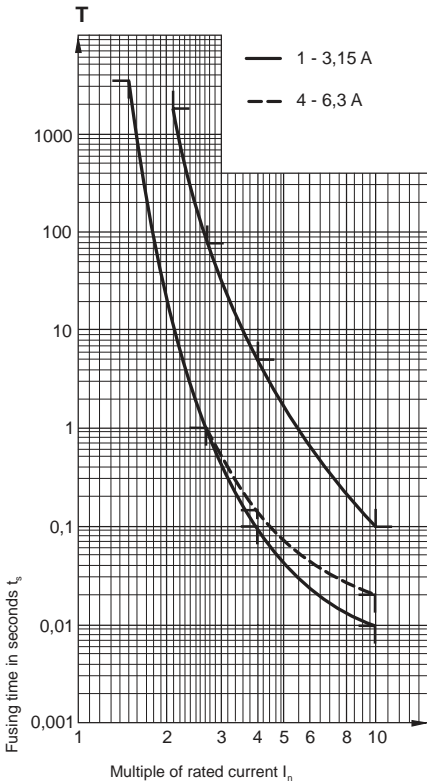

Approvals:

UL	recognition	500mA-16A*	File #E41599
CSA	acceptance	500mA-16A*	File #LR51172
VDE	approval	1A-6.3A	File #75036
SEMKO	approval	1A-6.3A	} File numbers on request
SEV	approval	1A-6.3A	

* fuses with pigtail leads approved up to 8A (factory assembled only)

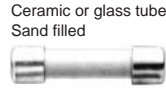

NEW



New version with gold plated caps for direct pcb mounting

cUL	recognition	1A-16A/250V**	pending
VDE	approval	1A-6.3A/250V**	pending

**Contact Schurter for part numbers

Time Current Characteristics

rated current I_n	$n \cdot I_n$	$1.5 \cdot I_n$		$2.1 \cdot I_n$		$2.75 \cdot I_n$		$4 \cdot I_n$		$10 \cdot I_n$	
		min.	max.	min.	max.	min.	max.	min.	max.	min.	max.
SCHURTER IEC	500mA – 800mA 1A – 3.15A	60 min.	30 min.	1 s	80 s	95 ms	5 s	10 ms	100 ms		
IEC SCHURTER	4A – 6.3A 8A – 16A	60 min.	30 min.	1 s	80 s	150 ms	5 s	20 ms	100 ms		

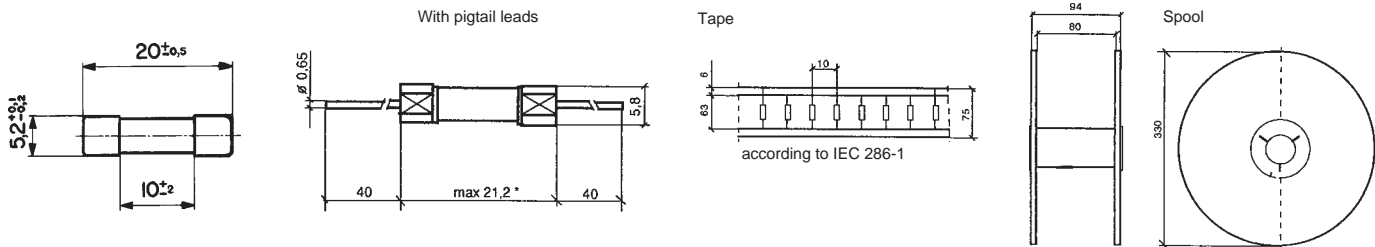

Order Numbers	Rated current / rated voltage mA / A / V~	Breaking capacity A~ ac	Voltage drop at I_n		Power dissipation at $1.5 \cdot I_n$			Pre-arcing $I^2 t$ at $10 \cdot I_n$ A ² s	Approvals					
			max. IEC 127 mV	typical Schurter mV	max. IEC 127 Watts	max. Schurter Watts	typical Schurter Watts		UL	CSA	VDE	SEMKO	SEV	
0001.2501	500 mA* / 250V	UL: 10,000A / 125V, p.f. 0.7-0.8 IEC: 1,500A / 250V, p.f. 0.7-0.8		360			0.5	0.50	•	•				
0001.2502	630 mA* / 250V			330			0.5	1.55	•	•				
0001.2503	800 mA* / 250V			260			0.5	2.30	•	•				
0001.2504	1 A / 250V			180	2.5	0.7	0.5	1.10	•	•				
0001.2505	1.25 A / 250V			250	2.5	0.7	0.5	1.86	•	•				
0001.2506	1.6 A / 250V			200	2.5	0.7	0.5	4.35	•	•				
0001.2507	2 A / 250V			190	2.5	0.8	0.6	9.20	•	•				
0001.2508	2.5 A / 250V			180	2.5	0.9	0.6	11.7	•	•				
0001.2509	3.15 A / 250V			140	4.0	1.1	0.8	33.7	•	•				
0001.2510	4 A / 250V			100	4.0	1.2	0.9	62.4	•	•				
0001.2511	5 A / 250V		100	4.0	1.5	1.2	97.5	•	•					
0001.2512	6.3 A / 250V		100	4.0	1.7	1.2	171	•	•					
0001.2513	8 A* / 250V	UL:1,000A / 250V, p.f. 1		70		1.9	1.3	268	•	•				
0001.2514	10 A* / 250V			70		2.8	2.1	400	•	•				
0001.2515	12.5 A* / 250V			70			3.1	563	•	•				
0001.2516	16 A* / 250V	UL:1,000A / 125V & 500A/250V, p.f. 1		70			4.0	1272	•	•				

*Not addressed in the standards

For pigtail fuses packaged loose: reference .PT after part number (e.g. 0001.2501.PT)

For pigtail fuses on 1,000-piece tape and reel: reference .TR after part number (e.g. 0001.2501.TR)

FST 5 x 20mm Time Lag Fuses – Low Breaking Capacity



Built according to IEC 127-2/3, EN 60127, SEV 1064, DIN/VDE 0820 part 1, DIN 41662, BS 4265, and SEMKO 104-1976, with support by UL 198G. Series SP & SPT recommended if the short circuit current through the fuse-link is more than 35A or $10 \times I_n$, whichever is greater (CENELEC Jan 1, 1993).

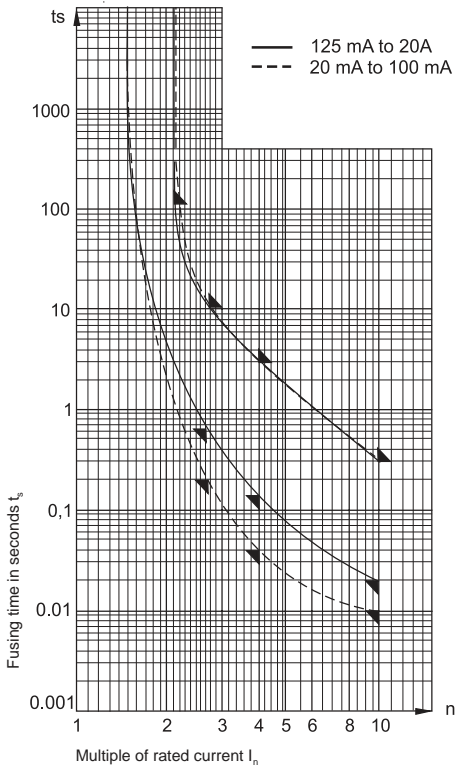

Approvals:

UL	recognition	32mA-16A*	File #E41599
CSA	acceptance	32mA-16A*	File #LR51172
VDE	approval	32mA-6.3A	File #50910
SEMKO	approval	32mA-6.3A	File #51550
SEV	approval	32mA-6.3A	} File numbers on request
BSI	license	125mA-6.3A	
CB	certification	32-40mA, 125mA-6.3A	
BEAB	approval	32-40mA, 125mA-6.3A	

* fuses with pigtail leads approved up to 8A (factory assembled only)



NEW

New version with gold plated caps for direct pcb mounting

cUL recognition 1A-16A/250V** pending
VDE approval 1A-16A/250V** pending

** Contact Schurter for part numbers

Time Current Characteristics

rated current I_n	$n \cdot I_n$		$1.5 \cdot I_n$		$2.1 \cdot I_n$		$2.75 \cdot I_n$		$4 \cdot I_n$		$10 \cdot I_n$	
	min.	max.	min.	max.	min.	max.	min.	max.	min.	max.	min.	max.
20mA – 100mA	60 min.	2 min.*	200 ms*	10 s*	40 ms	3 s	10 ms	300 ms				
125mA – 20A	60 min.	2 min.	600 ms	10 s	150 ms	3 s	20 ms	300 ms				

* These values are not guaranteed at 20mA

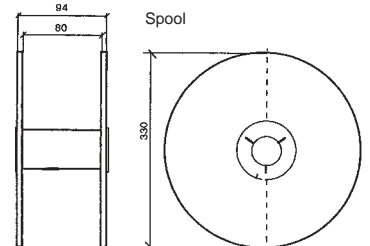
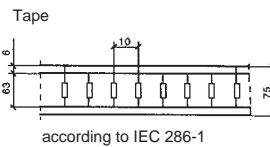
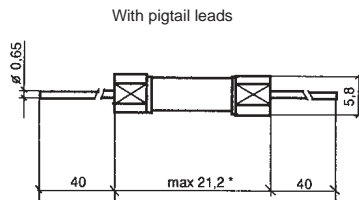
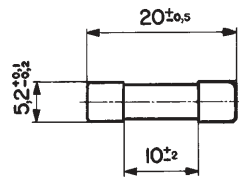

Order Numbers	Rated current / rated voltage	Breaking capacity	Voltage drop at I_n		Power dissipation at $1.5 \cdot I_n$			Pre-arcing $I^2 t$ at $10 \cdot I_n$ A ² s	Approvals										
			max. IEC 127 mV	typical Schurter mV	max. IEC 127 Watts	max. Schurter Watts	typical Schurter Watts		UL	CSA	VDE	SEMKO	SEV	BSI	CB	BEAB			
Series FST	mA / A / V~	A~																	
0034.3101	20 mA* / 250V	35A / 250 V / 50 Hz / p.f. 1		2700				0.1	0.0012										
0034.3102	32 mA / 250V			5000	3000	1.6		0.2	0.0019										
0034.3103	40 mA / 250V			4000	2100	1.6		0.2	0.0027										
0034.3104	50 mA / 250V			3500	950	1.6		0.125	0.0363										
0034.3105	63 mA / 250V			3000	1300	1.6		0.2	0.0401										
0034.3106	80 mA / 250V			3000	1100	1.6		0.3	0.0570										
0034.3107	100 mA / 250V			2500	1000	1.6		0.155	0.107										
0034.3108	125 mA / 250V			2000	565	1.6		0.2	0.064										
0034.3109	160 mA / 250V			1900	415	1.6		0.185	0.230										
0034.3110	200 mA / 250V			1500	270	1.6		0.2	0.256										
0034.3111	250 mA / 250V			1300	210	1.6		0.2	0.238										
0034.3112	315 mA / 250V			1100	170	1.6		0.2	0.544										
0034.3113	400 mA / 250V			1000	150	1.6		0.2	0.768										
0034.3114	500 mA / 250V			900	160	1.6		0.2	3.0										
0034.3115	630 mA / 250V			300	160	1.6		0.3	4.35										
0034.3116	800 mA / 250V		250	120	1.6		0.3	3.85											
0034.3117	1 A / 250V		150	60	1.6		0.4	3.30											
0034.3118	1.25 A / 250V		150	60	1.6		0.5	5.50											
0034.3165*	1.4 A* / 250V			60				7.45											
0034.3119	1.6 A / 250V		150	60	1.6		0.5	10.5											
0034.3120	2 A / 250V		150	60	1.6		0.6	16											
0034.3121	2.5 A / 250V		120	60	1.6		0.7	21.9											
0034.3122	3.15 A / 250V		100	60	1.6		0.8	47											
0034.3123	4 A / 250V		100	60	1.6		1.1	68.3											
0034.3124	5 A / 250V		100	60	1.6		1.2	102											
0034.3125	6.3 A / 250V		100	60	1.6		1.3	190											
0034.3126	8 A* / 250V	10 • I_n 250V / 50 Hz / p.f. 1		60			1.6	275											
0034.3127	10 A* / 250V			60			1.8	520											
0034.3128	12.5 A* / 250V			60				750											
0034.3129	16 A* / 250V			60				1638											
0034.3130	20 A* / 250V			60				3057											

*Not addressed in the standards; 1.4A SEMKO approved only.

For pigtail fuses packaged loose: reference .PT after part number (e.g. 0034.3101.PT)

For pigtail fuses on 1,000-piece tape and reel: reference .TR after part number (e.g. 0034.3101.TR)

FTT 5 x 20mm Super Time Lag Fuses – Low Breaking Capacity

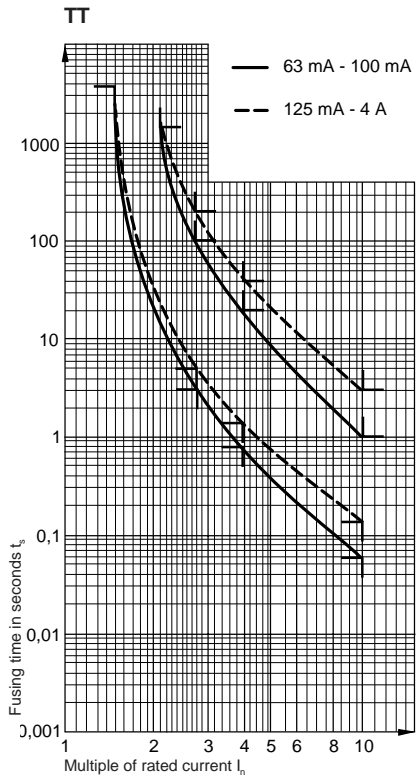

Approvals:
 UL recognition 63mA-4A/250V File #E41599

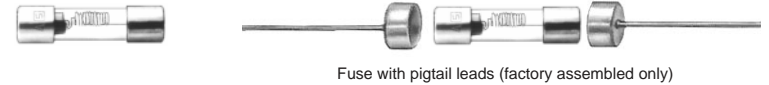

NEW



cUL recognition 50mA-4A/250V** pending

**Contact Schurter for part numbers

Time Current Characteristics

n • I _n rated current I _n	1.5 • I _n		2.1 • I _n		2.75 • I _n		4 • I _n		10 • I _n	
	min.	max.	min.	max.	min.	max.	min.	max.	min.	max.
63mA – 100mA	60 min.	30 min.	3 s	100 s	800 ms	20 s	0.06 s	1 s		
125mA – 4A	60 min.	30 min.	5 s	200 s	1.5 s	40 s	0.15 s	3 s		

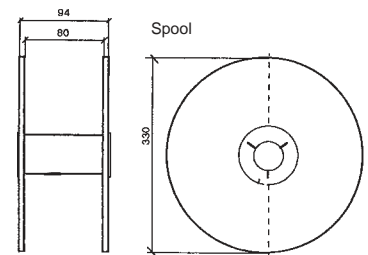
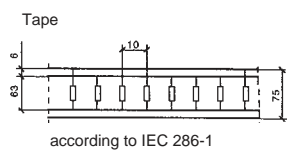
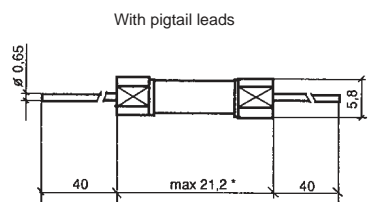
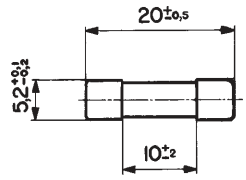

Order Numbers	Rated current / rated voltage	Breaking capacity	Voltage drop at I _n		Power dissipation at 1.5 • I _n		Operating I ² t
			max. Schurter mV	typical Schurter mV	max. Schurter Watts	typical Schurter Watts	
Series FTT	mA / A / V~	A~					A ² s
0034.5001	63 mA / 250V	35A / 250 V / 50 Hz / p.f. 1	5000	1000	1.6	0.22	2.4
0034.5002	80 mA / 250V		4500	980	1.6	0.27	2.5
0034.5003	100 mA / 250V		4000	870	1.6	0.30	2.8
0034.5004	125 mA / 250V		3000	500	1.6	0.27	2.2
0034.5035	160 mA / 250V		2000	450	1.6	0.30	3.7
0034.5036	200 mA / 250V		1500	400	1.6	0.33	3.7
0034.5037	250 mA / 250V		1200	330	1.6	0.35	3.7
0034.5038	315 mA / 250V		1000	300	1.6	0.36	4.2
0034.5039	400 mA / 250V		1200	225	1.6	0.40	5.6
0034.5040	500 mA / 250V		800	250	1.6	0.44	8.0
0034.5041	630 mA / 250V		700	200	1.6	0.47	9.0
0034.5042	800 mA / 250V		500	160	1.6	0.54	18
0034.5043	1 A / 250V		250	150	1.6	0.54	20
0034.5044	1.25 A / 250V		200	130	1.6	0.57	31
0034.5045	1.6 A / 250V		200	100	1.6	0.65	71
0034.5046	2 A / 250V		200	100	1.6	0.80	113
0034.5047	2.5 A / 250V		150	90	1.6	0.85	230
0034.5048	3.15 A / 250V		100	90	1.6	1.0	405
0034.5049	4 A / 250V		100	80	1.6	1.15	476

For pigtail fuses packaged loose: reference .PT after part number (e.g. 0034.5001.PT)
 For pigtail fuses on 1,000-piece tape and reel: reference .TR after part number (e.g. 0034.5001.TR)

FSQ 5 x 20mm Quick-acting Fuses



Built according to UL 248.14 and CSA 22.2 (recommended over 1/4 x 1 1/4" fuses for domestic use in UL/CSA approved fuseholders and/or power entry modules where space is a limiting factor).

Approvals:

UL listing 400mA-3.5A File #E41599
 CSA certification 400mA-3.5A File #LR51172

Replaces Series FNB

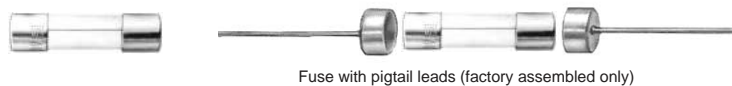
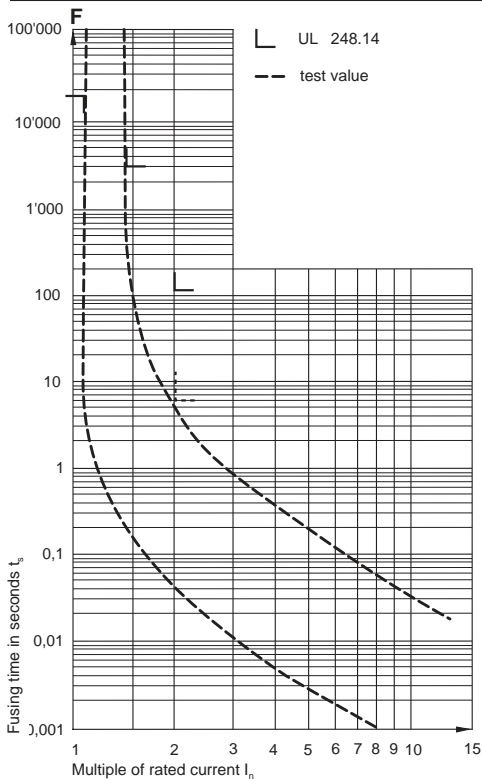

Time Current Characteristics

rated current I_n	$n \cdot I_n$	$1.1 \cdot I_n$	$1.35 \cdot I_n$	$2 \cdot I_n$
			min.	max.
400mA – 3.5A		4 h	1 hr	2 min.

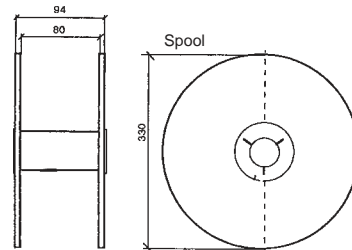
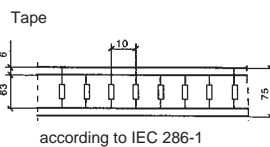
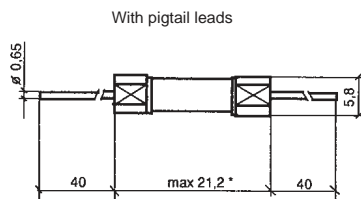
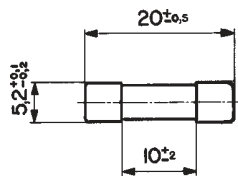

Order Numbers	Rated current / rated voltage	Breaking capacity	Voltage drop at I_n	Power dissipation at $1.1 \cdot I_n$	Operating $I^2 t$	Approvals		
						UL	CSA	
Series FSQ	mA / A / V	A~	typical mV	max. Watts	A ² s			
0034.3951	400 mA / 250V	10,000A / 125V p.f. 0.7 – 0.8	170	0.1	0.1	•	•	
0034.3952	500 mA / 250V		140	0.1	0.2	•	•	
0034.3953	600 mA / 250V		150	0.1	0.26	•	•	
0034.3954	700 mA / 250V		150	0.2	0.4	•	•	
0034.3955	750 mA / 250V		35A / 250V	150	0.2	0.6	•	•
0034.3956	800 mA / 250V		p.f. 0.7 – 0.8	140	0.2	0.7	•	•
0034.3957	1 A / 250V			120	0.2	1.2	•	•
0034.3958	1.2 A / 250V	10,000A / 125V p.f. 0.7 – 0.8	110	0.2	1.8	•	•	
0034.3959	1.25 A / 250V		110	0.2	1.8	•	•	
0034.3960	1.5 A / 250V		110	0.3	3	•	•	
0034.3961	1.6 A / 250V		110	0.3	3.8	•	•	
0034.3962	1.8 A / 250V		100	0.3	4.0	•	•	
0034.3963	2 A / 250V		100	0.3	4.5	•	•	
0034.3964	2.25 A / 250V		100	0.3	6.8	•	•	
0034.3965	2.5 A / 250V		100A / 250V	100	0.4	11	•	•
0034.3966	2.8 A / 250V		p.f. 0.7 – 0.8	100	0.5	13	•	•
0034.3967	3 A / 250V			100	0.5	15	•	•
0034.3968	3.2 A / 250V		100	0.5	20	•	•	
0034.3969	3.5 A / 250V		90	0.5	26	•	•	

For pigtail fuses packaged loose: reference .PT after part number (e.g. 0034.3951.PT)
 For pigtail fuses on 1,000-piece tape and reel: reference .TR after part number (e.g. 0034.3951.TR)

FSD 5 x 20mm Time Delay Fuses

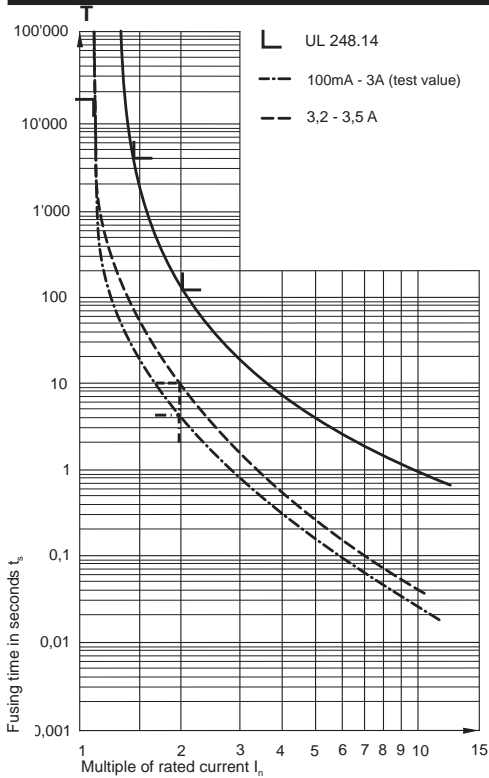

Built according to UL 248.14 (formerly 198G) and CSA C22.2 (formerly 59.2-M). Recommended over 1/4 x 1 1/4" fuses for domestic use in UL/CSA approved fuseholders and/or power entry modules where space is a limiting factor.

Approvals:

UL listing	100mA-2A	File #E41599
CSA certification	100mA-2A	File #LR51172

Replaces Series FSP



Time Current Characteristics

n • I _n rated current I _n	1.1 • I _n	1.35 • I _n	2 • I _n	
	min.	max.	min.	max.
100mA - 2A	4 h	1 h	5 s	2 min.

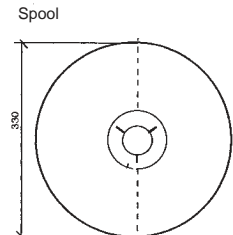
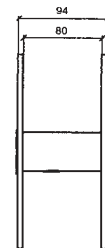
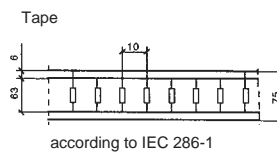
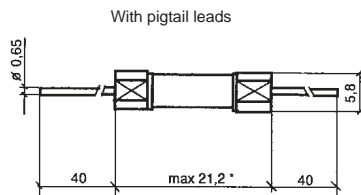
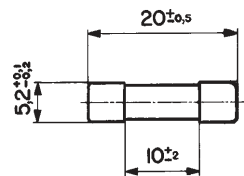

Order Numbers	Rated current / rated voltage	Breaking capacity	Voltage drop at I _n	Power dissipation at 1.1 • I _n	Pre-arcing I ² t at 10 • I _n	Approvals		
						UL	CSA	
Series FSD	mA / A / V	A~	typ. mV	typ. Watts	typ. A ² s			
0034.3972	100 mA / 250V	10,000A / 125V p.f. 0.7 - 0.8	1550	0.16	.044	•	•	
0034.3973	125 mA / 250V		1240	0.15	.084	•	•	
0034.3974	150 mA / 250V		1240	0.19	.131	•	•	
0034.3975	175 mA / 250V		1000	0.18	.239	•	•	
0034.3976	187 mA / 250V		910	0.17	.335	•	•	
0034.3977	200 mA / 250V		890	0.18	.337	•	•	
0034.3978	250 mA / 250V		770	0.19	.486	•	•	
0034.3979	300 mA / 250V		700	0.21	.621	•	•	
0034.3980	375 mA / 250V		510	0.19	1.18	•	•	
0034.3981	400 mA / 250V		35A / 250V p.f. 0.7 - 0.8	540	0.21	3.5	•	•
0034.3982	500 mA / 250V			470	0.23	2	•	•
0034.3983	600 mA / 250V			380	0.23	6.19	•	•
0034.3984	700 mA / 250V			360	0.25	6.32	•	•
0034.3985	750 mA / 250V			270	0.21	7.99	•	•
0034.3986	800 mA / 250V	330		0.26	8.06	•	•	
0034.3987	1 A / 250V	270		0.27	10.6	•	•	
0034.3988	1.2 A / 250V	10,000A / 125V p.f. 0.7 - 0.8	240	0.30	18.9	•	•	
0034.3989	1.25 A / 250V		240	0.31	20.8	•	•	
0034.3990	1.5 A / 250V		210	0.32	21.9	•	•	
0034.3991	1.6 A / 250V	100A / 250V p.f. 0.7 - 0.8	200	0.32	30	•	•	
0034.3992	1.8 A / 250V		190	0.34	34.7	•	•	
0034.3993	2 A / 250V		180	0.37	56	•	•	

For pigtail fuses packaged loose: reference .PT after part number (e.g. 0034.3972.PT)

For pigtail fuses on 1,000-piece tape and reel: reference .TR after part number (e.g. 0034.3972.TR)

FNB 5 x 20mm Normal Blow Fuses



Built according to UL 248.14 and CSA C22.2.

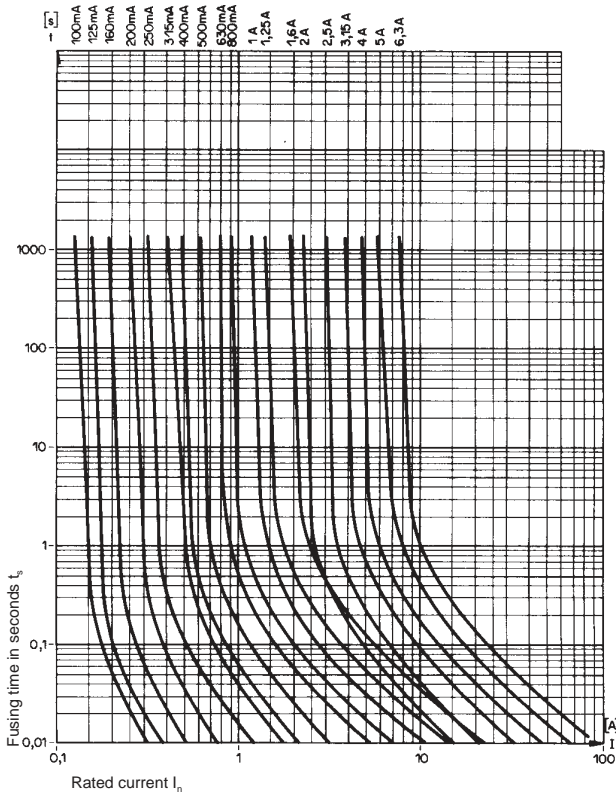

Approvals:

UL listing	100mA-5A	File #E41599
CSA certification	100mA-5A	File #LR36410
(listed as series GGS)		

Fuse with pigtail leads (factory assembled only)



Note: Not recommended for new designs. Refer to FSQ, pg. 151

FNB Time Current Characteristics

$n \cdot I_n$	$1.1 \cdot I_n$	$1.35 \cdot I_n$	$2 \cdot I_n$
rated current I_n		max.	max.
100mA – 6.3A	continuous	1 h	2 min.

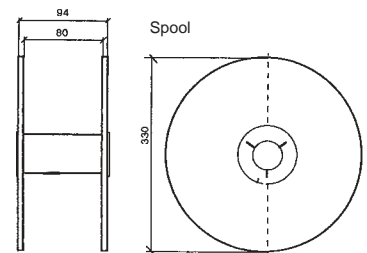
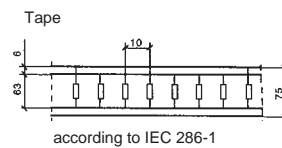
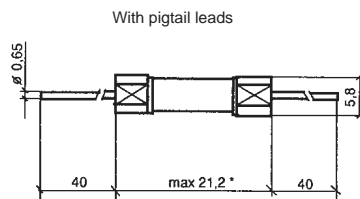
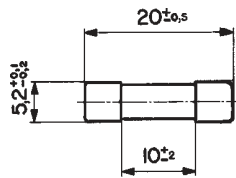

Order Numbers	Rated current / voltage	Breaking capacity	Voltage drop	Fusing $I^2 t$ $t < 10ms$	Approvals
Series FNB	mA / A / V	A	mV	A ² s	UL CSA
0034.3920	100 mA / 250V	According to UL 198.G	N / A	N / A	• •
0034.3921	125 mA / 250V				• •
0034.3922	160 mA / 250V				• •
0034.3923	200 mA / 250V				• •
0034.3924	250 mA / 250V				• •
0034.3925	315 mA / 250V				• •
0034.3926	400 mA / 250V				• •
0034.3927	500 mA / 250V				• •
0034.3928	630 mA / 250V				• •
0034.3929	800 mA / 250V				• •
0034.3930	1 A / 250V				• •
0034.3931	1.25 A / 125V				• •
0034.3932	1.6 A / 125V				• •
0034.3933	2 A / 125V				• •
0034.3934	2.5 A / 125V				• •
0034.3935	3.15 A / 125V				• •
0034.3936	4 A / 125V				• •
0034.3937	5 A / 125V				• •
0034.3938	6.3 A / 125V	• •			

For pigtail fuses packaged loose: reference .PT after part number (e.g. 0034.3920.PT)
 For pigtail fuses on 1,000-piece tape and reel: reference .TR after part number (e.g. 0034.3920.TR)

FSP 5 x 20mm Surge Proof Fuses



Built according to UL 248.14 (formerly 198G) and CSA C22.2 (formerly 59.2-M)

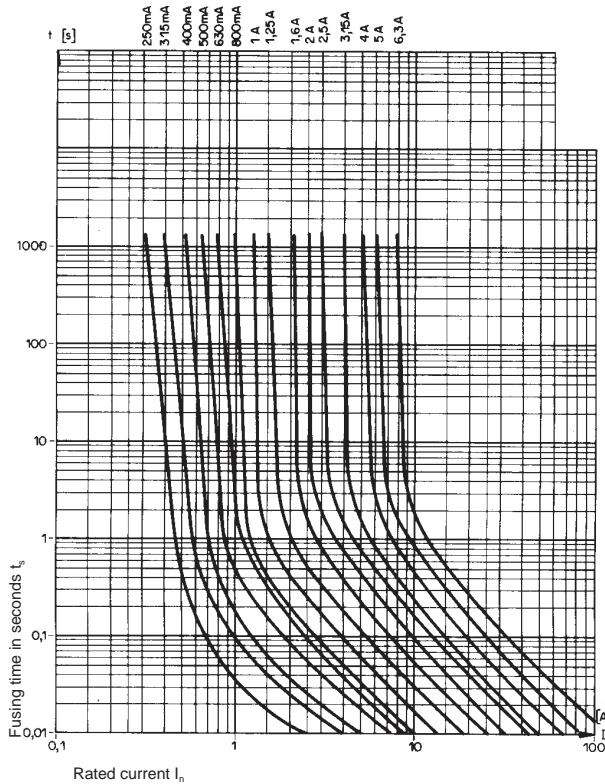

Approvals:

- UL listing (250mA-6.3A) File #E41599 (listed as series SB)
- CSA certification (250mA-6.3A) File #LR51172 (listed as series SB, File #LR36410)

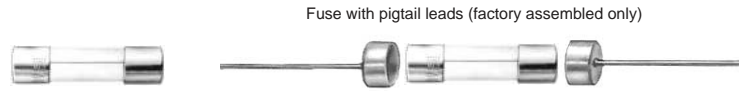

Note: Not recommended for new designs. Refer to FSD, pg. 152

Time Current Characteristics

$n \cdot I_n$	$1.1 \cdot I_n$	$1.35 \cdot I_n$	$2 \cdot I_n$
rated current I_n		max.	max.
250mA – 6.3A	continuous	1 h	2 min.

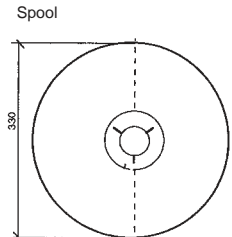
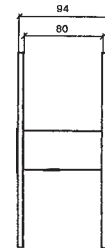
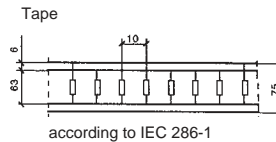
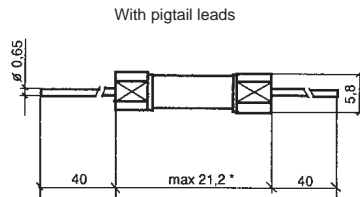
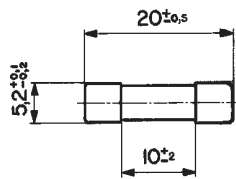

Order Numbers	Rated current / rated voltage	Breaking capacity	Voltage drop at I_n	Power dissipation at $1.1 \cdot I_n$	Fusing $I^2 t$ at $10 \cdot I_n$	Approvals	
						UL	CSA
Series FSP	mA / A / V	A~	max. mV	max. Watts	A ² s		
0034.3901	250 mA / 250V	According to UL 198.G	N/A		N/A	•	•
0034.3902	315 mA / 250V					•	•
0034.3903	400 mA / 250V					•	•
0034.3904	500 mA / 250V					•	•
0034.3905	630 mA / 250V					•	•
0034.3906	800 mA / 250V					•	•
0034.3907	1 A / 250V					•	•
0034.3908	1.25 A / 125V					•	•
0034.3909	1.6 A / 125V					•	•
0034.3910	2 A / 125V					•	•
0034.3911	2.5 A / 125V					•	•
0034.3912	3.15 A / 125V					•	•
0034.3913	4 A / 125V					•	•
0034.3914	5 A / 125V					•	•
0034.3915	6.3 A / 125V					•	•

For pigtail fuses packaged loose: reference .PT after part number (e.g. 0034.3901.PT)
 For pigtail fuses on 1,000-piece tape and reel: reference .TR after part number (e.g. 0034.3901.TR)

A3BK 10.3 x 38mm Quick-acting Fuses - High Breaking Capacity



Built according to UL 248.14 (formerly 198G)

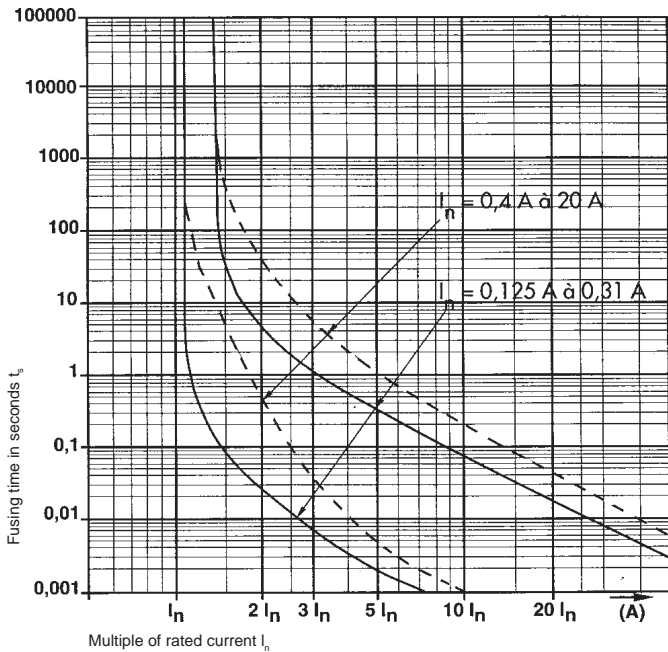

Approvals:

UL listing	1A-15A	File #E42088
CSA certification	1A-15A	File #LR34549

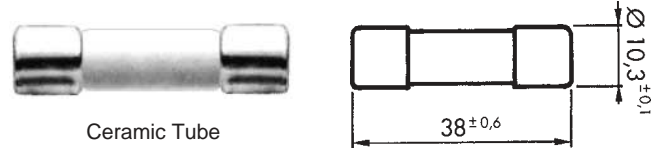

Ceramic Tube

Time Current Characteristics

Rated Current	1.1 • In min.	1.35 • In max.	2 • In max.
125mA-20A	1 h	1 h	120 s

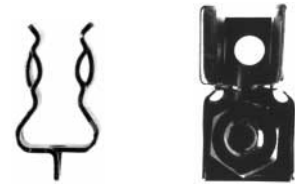

For information about printed circuit board or screw mount 10.3 x 38mm fuse clips, please see page 92

Order Number Type A3BK	Rated Current mA/A~	Rated Voltage V~	Breaking Capacity A	Voltage Drop mV	Approvals		
					UL	CSA	
7024.9110	125mA	300	10,000 A/300V AC p.f. = 0.7-0.8	2370			
7024.9120	160mA			2600			
7024.9130	200mA			2200			
7024.9140	250mA			1760			
7024.9150	310mA			1600			
7024.9160	400mA			2380			
7024.9170	500mA			2750			
7024.9180	630mA			2500			
7024.9190	800mA			580			
7024.9210	1A			900		•	•
7024.9220	1.25A			1100		•	•
7024.9230	1.60A			460		•	•
7024.9240	2A			400		•	•
7024.9250	2.50A			380		•	•
7024.9260	3.15A			350		•	•
7024.9270	4A			260		•	•
7024.9310	8A			270		•	•
7024.9320	10A					•	•
7024.9330	12.5A					•	•
7024.9340	15A					•	•

Fuse Kits



FSF
5x20 mm

Quick-acting, low-breaking
Built to IEC 127-2/2. UL, VDE, SEMKO, SEV. 270 pieces: 15 each, 100mA-10A
Order no. 0034.9856



FST
5x20 mm

Time-delay, low-breaking
Built to IEC 127-2/3. UL, VDE, SEMKO, SEV, BSI, CB. 270 pieces: 15 each, 100mA-10A
Order no. 0034.9857



FST / SP
5x20 mm

Time-delay, low-breaking / fast-acting, high-breaking
Built to IEC 127-2/3 and 2/1. UL, VDE, SEMKO, SEV, CB. 270 pieces: 15-30 each, 500mA-10A
Order no. 0034.9858



SP / SPT
5x20 mm

Quick-acting, high-breaking / time-delay, high-breaking
Built to IEC 127-2/1 and 2/5. UL, VDE, SEMKO, SEV. 180 pieces: 10 each, 800mA-10A
Order no. 0034.9871



MSF 125
Microfuse

Quick-acting, low-breaking
Built to IEC 127-3/1, CSA 59.2-M. UL, CSA. 180 pieces: 10 each, 50mA-5A, 10 each MSF holder
Order no. 0034.9875



MSF / MST 250
Microfuse

Quick-acting, low breaking
Built to IEC 127-3/3 and 3/4. UL, VDE, SEMKO, SEV. 180 pieces: 10 each, 63mA-5A, 10 each MSF holder
Order no. 0034.9876



OMF63 / OMF250
Surface mount

OMF 63: Quick-acting, low-breaking
Built to CSA 59.2-M. UL, CSA. 90 pieces: 10 each, 100mA-5A, 10 each OMF 63 holder
OMF 250: Quick-acting, medium-breaking
Built to IEC 127-4 trend document. 90 pieces: 10 each, 500mA-4A, 10 each OMF 250 holder
Order no. 0034.9877

FSF	FST	FST / SP	SP / SPT	MSF 125	MSF / MST 250	OMF 63 / OMF 250
FSF 160 mA	FST 160 mA	FST 500 mA	SP 800 mA	MSF 50 mA	MSF 50 mA	OMF63 100 mA
FSF 200 mA	FST 200 mA	FST 1 A	SP 1 A	MSF 100 mA	MSF 80 mA	OMF63 250 mA
FSF 250 mA	FST 250 mA	FST 1.25 A	SP 1.6 A	MSF 125 mA	MSF 315 mA	OMF63 630 mA
FSF 315 mA	FST 315 mA	FST 1.6 A	SP 2 A	MSF 200 mA	MSF 500 mA	OMF63 1 A
FSF 400 mA	FST 400 mA	FST 2 A	SP 2.5 A	MSF 250 mA	MSF 1 A	OMF63 1.25 A
FSF 500 mA	FST 500 mA	FST 2.5 A	SP 3.15 A	MSF 315 mA	MSF 2 A	OMF63 1.6 A
FSF 630 mA	FST 630 mA	FST 3.15 A	SP 5 A	MSF 400 mA	MSF 3.15 A	OMF63 2 A
FSF 800 mA	FST 800 mA	FST 6.3 A	SP 6.3 A	MSF 500 mA	MSF 5 A	OMF63 3.5 A
FSF 1 A	FST 1 A	FST 10 A	SP 10 A	MSF 630 mA		OMF63 5 A
FSF 1.25 A	FST 1.25 A			MSF 800 mA	MST 63 mA	
FSF 1.6 A	FST 1.6 A	SP 500 mA	SPT 800 mA	MSF 1 A	MST 80 mA	OMF250 500 mA
FSF 2 A	FST 2 A	SP 1 A	SPT 1 A	MSF 1.25 A	MST 160 mA	OMF250 800 mA
FSF 2.5 A	FST 2.5 A	SP 3.15 A	SPT 1.6 A	MSF 1.6 A	MST 315 mA	OMF250 1 A
FSF 4 A	FST 4 A	SP 6.3 A	SPT 2 A	MSF 2 A	MST 500 mA	OMF250 1.25 A
FSF 5 A	FST 5 A	SP 10 A	SPT 2.5 A	MSF 3.15 A	MST 1 A	OMF250 1.6 A
FSF 6.3 A	FST 6.3 A		SPT 3.15 A	MSF 4 A	MST 1.25 A	OMF250 2 A
FSF 10 A	FST 10 A		SPT 5 A	MSF 5 A	MST 2 A	OMF250 3.15 A
			SPT 6.3 A	MSF 10 A	MST 3.15 A	OMF250 4 A
			SPT 10 A			

Please refer to the catalog page for each fuse type for exact approval information

Surge Tolerant Fuses

Application Notes

Introduction

Telecommunication equipment acts as a source for data exchange between subscribers. Communication takes place in various ways, e. g. telephone, FAX etc.

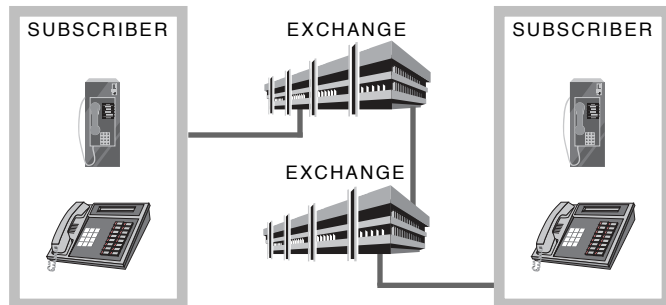

Distances between individual subscribers (man, machine) can vary significantly thereby subjecting network connections (overhead lines, signal cables) to various interferences caused by:

- Atmospheric interference, (lightning strike, switching operations)
- Interference by power induction (equalizing currents, vicinity of power cables)
- Direct contact with energy network (short-circuits)

Interference sources

Atmospheric interference (Lightning Strike)

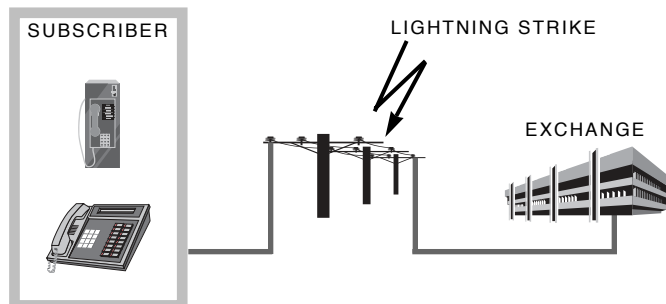

Interference due to lightning strikes occurs frequently on exposed overhead telephone lines. Voltages as a result of this atmospheric discharge can be 100 kV with discharge currents up to 150 kA.

Interference by induction (Power Induction)

Induction voltages occurring as interference on telecom lines are usually a result of circulating or equalizing currents in the earth or are produced by strong currents in adjacent power cables.

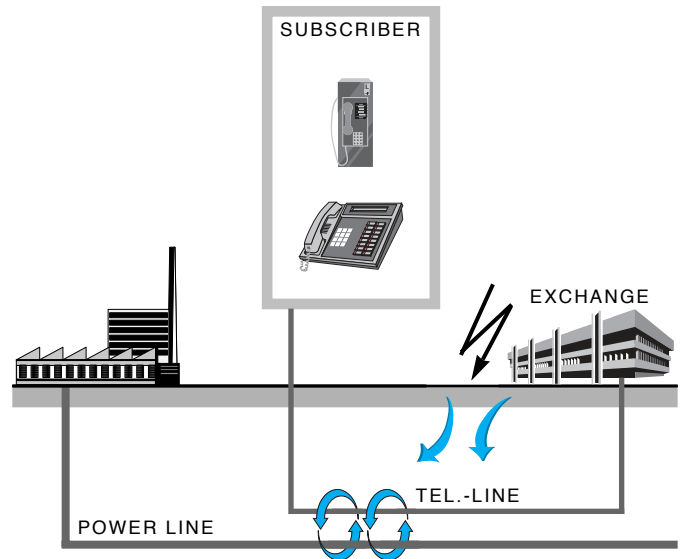

Direct contact with the power network (Power Contact)

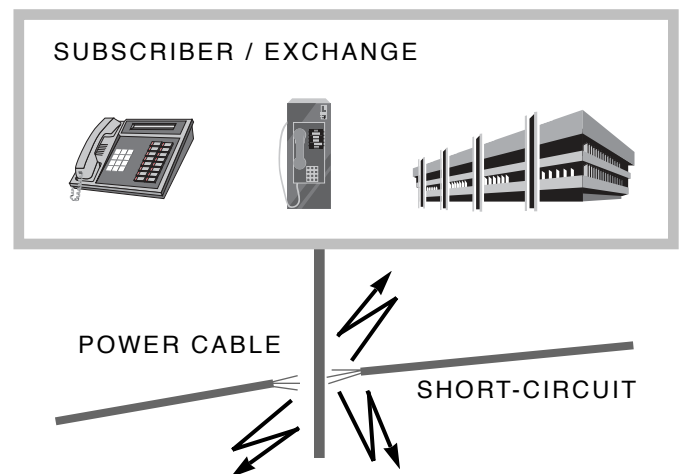

Interference of unusually high intensity and long duration (a few seconds to several minutes) on a telephone line occurs when there is direct contact with a power network (e.g. short-circuit with an adjacent power cable).

Surge Tolerant Fuses

Protection of equipment

Regardless of the type of interference affecting telecom equipment, it is imperative that no damage occurs, or only limited damage whose effects can be calculated.

As shown below, this requirement can be satisfied by the use of appropriate protection circuits.

Protection circuits in the telecom branch are usually designed on the two-stage principle. They comprise of primary and secondary protection.

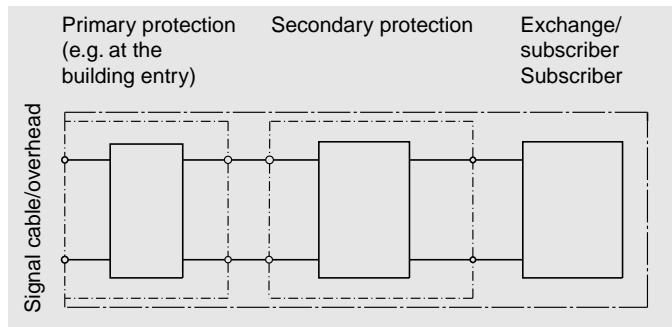

Primary protection

Primary protection is frequently comprised of a combination of resistors and surge arrestors and is usually located at the «building entry» interface.

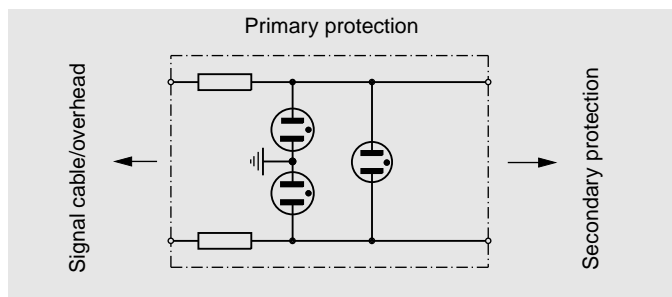

The task of the illustrated primary protection circuit is to sufficiently reduce the high-energy interference distortion so that it can be safely absorbed by the following secondary protection.

Secondary protection

The secondary protection is normally located directly at the appliance entry of the telecom equipment and has two objectives.

1. It operates as a voltage limiter which ensures that interference up to a defined amplitude, not yet capable of activating the primary protection, is absorbed or reduced to a harmless level for the telecom equipment.
2. It effectively suppresses high energy level interferences, which can no longer be adequately absorbed by the primary protection (e.g. in case of direct contact between the signal lines and the power network), by galvanic decoupling of the circuit. This prevents the occurrence of serious damage, even fire, in the telecom equipment.

The following diagram shows a frequently used, extremely reliable protection circuit for this purpose.

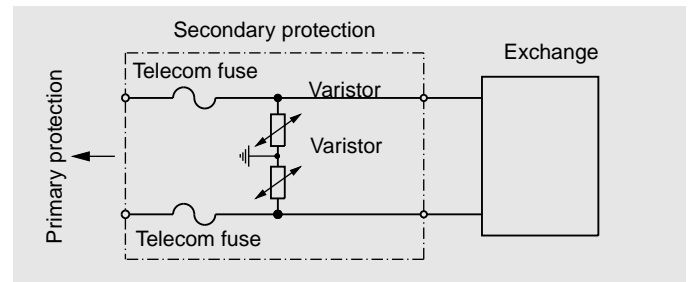

The circuit, which in its simplest form is comprised of two fuses and two varistors, is characterized by an extremely attractive cost-benefit ratio. The varistors limit the interference voltage peaks to a level compatible for the telephone exchange, and respectively, the subscriber circuit. Under normal conditions, the fuses remain intact.

Under worst-case conditions, e.g. direct contact with the power network, where both the telecom equipment components and the varistors in the protection circuit would be seriously damaged or destroyed, the fuses interrupt the circuit thereby effectively and reliably protecting the telecom equipment.

Surge Tolerant Fuses

Testing: Introduction

Several standards have been established for the Telecom industry, all of which are aimed at combining the interference influences of Lightning Surge, Power Induction and Power Contact, together with the associated safety aspects, and to derive suitable testing methods for the components in question.

Various kinds of loads have been defined and standardised as testing criteria. They can be simulated with the aid of an appropriate test circuit. This provides circuit designers with the facility for optimally adapting the stages of a protection circuit to one another.

Current relevant standards are:

- ITU-T K.20** International Telecommunication Union, Standardisation Sector of ITU
- UL 1459/1950** Standard for Safety, Telephone Equipment (USA)
- GR 1089 Core** Bell Communications Research (USA)

Tests :

Schurter fuses have been tested according to the following standards and testing criteria (this list is not exhaustive):

1. ITU-T K.20

Lightning Surge: Test circuit

Fig. 1

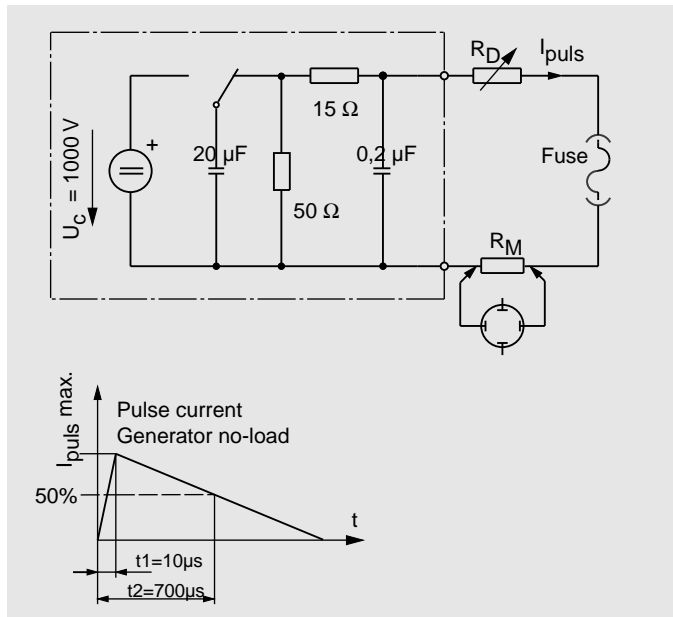

Test:

1. The pulse amplitude (generator no-load) is set to 1000 V and the pulse shape to 10 µs / 700 µs.
2. The pulse current I_{puls} is set to the value $I_{puls\ max}$ stated in the data sheet with limiting resistor R_D .
3. Test mode : 10 single pulses, at an interval of 60 sec. alternating polarity.

Requirement: The fuse shall not interrupt the circuit.

1) Note:

With a charge voltage of $U_C = 1000\text{ V}$, the standardized pulse generator in Fig. 1 supplies a maximum pulse current $I_{puls} = 67\text{ A}$, providing the current limiting resistor is $R_D = 0\Omega$. The shunt R_M for the current monitoring has a very low resistance and has therefore no notable influence to the current amplitude. This means that the data sheet current 67 A (1) does not represent the maximum permissible pulse amplitude of the fuse in question, but the maximum current amplitude which can be supplied by the pulse generator. If a max. current higher than 67 A is to be expected in a circuit, the I^2t -values of the fuse can be calculated using the formula $I^2t = 0,72 \times i^2_{peak} \times t_2$, as a good approximation in order that the selected fuse can accept the expected current pulse without interrupting the circuit.

Power induction: Test circuit

Fig. 2

Test: The fuse in the test circuit AC 300 V / 50 Hz is loaded 5

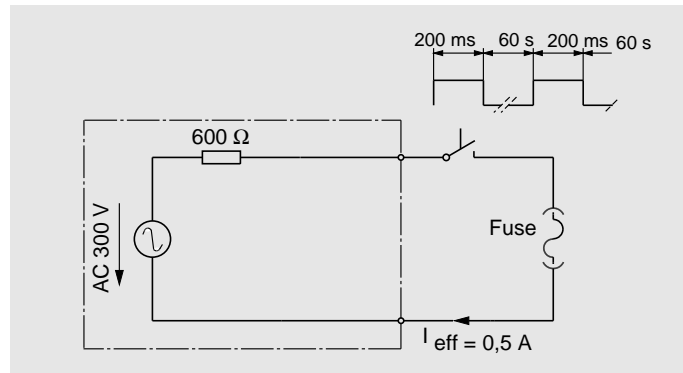

times with $I_{eff} = 0,5\text{ A}$ for 200 ms at intervals of 60 sec.

Requirement: The fuse shall not interrupt the circuit.

Power Contact: Test circuit

Fig. 3

Test: The fuse in the test circuit AC 250 V / 50 Hz is loaded with the current value I_{sc} stated in the data sheet. The supply

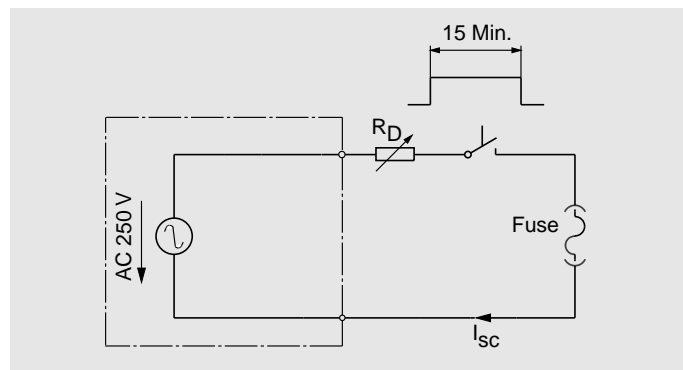

voltage is maintained for 15 minutes.

Requirement: The fuse shall interrupt the circuit.

Surge Tolerant Fuses

2. UL1459/1950

Test circuit

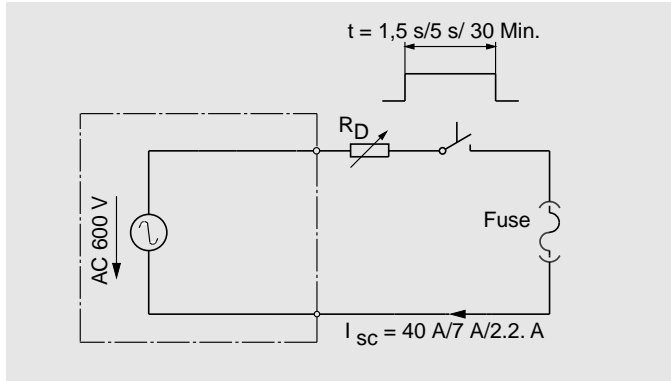

Fig. 4

Test 1:

The fuse in the test current circuit is loaded with a test current of $I_{SC} = 40 \text{ A}$. The AC 600 V / 50 Hz source voltage is applied for a total of 1.5 sec.

Requirement: The fuse shall interrupt the circuit.

Test 2:

The fuse in the test current circuit is loaded with a test current of $I_{SC} = 7 \text{ A}$. The AC 600 V / 50 Hz source voltage is applied for a total of 5 sec.

Requirement: The fuse shall interrupt the circuit.

Test 3

The fuse in the test current circuit is loaded with a test current of $I_{SC} = 2,2 \text{ A}$. The AC 600 V / 50Hz source voltage is applied for at least 30 minutes, or until stable thermal conditions are achieved in the telecom unit or until the fuse interrupts the circuit. This test is performed together with the equipment in which the fuse is installed.

3. GR 1089

Test circuit

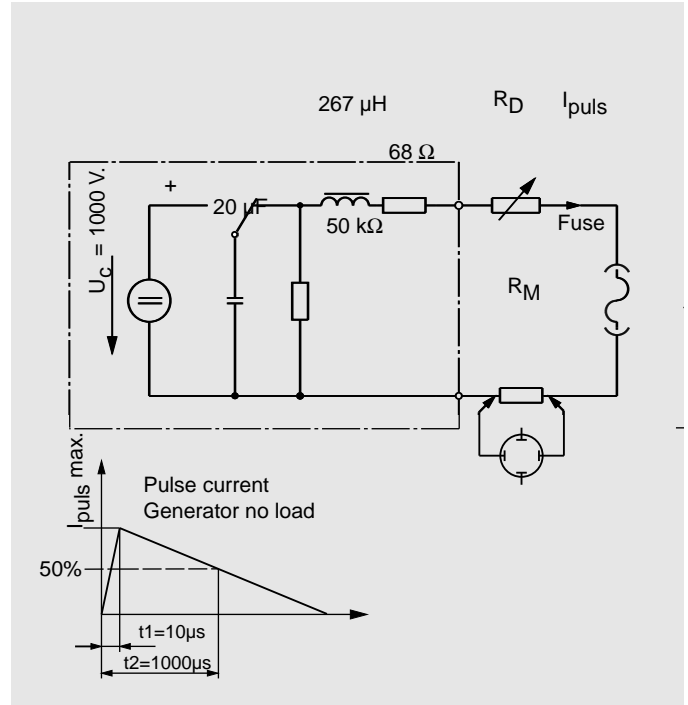

Fig. 5

Test:

1. The pulse amplitude (generator no-load) is set to 1000 V and the pulse shape to 10 μs / 1000 μs .
2. The pulse current I_{puls} is set to the value $I_{puls \text{ max.}}$ stated in the data sheet with limiting resistor R_D .
3. Test mode: 50 single pulses, at an interval of 60 sec. alternating polarity.

Requirement: The fuse shall not interrupt the circuit.

5) **Note:** With a charge voltage of $U_C = 1000 \text{ V}$, the standardized pulse generator in Fig. 5 supplies a maximum pulse current $I_{puls} = 14 \text{ A}$, providing the current limiting resistor is $R_D = 0\Omega$. The shunt R_M for the current monitoring has a very low resistance and has no notable influence to the current amplitude. This means that the data sheet current 14 A ⁽⁵⁾ does not represent the maximum permissible pulse amplitude of the fuse in question, but the maximum current amplitude which can be supplied by the pulse generator. If a max. current higher than 14 A is to be expected in a circuit, the I^2t - values of the fuse can be calculated using the formula $I^2t = 0,72 \times i^2_{\text{peak}} \times t_2$, as a good approximation in order that the selected fuse can accept the expected current pulse without interrupting the circuit.

Surge Tolerant Surface Mount Fuses

OSU 125 V fuses for surface mounting

can be soldered directly onto printed circuit board or inserted into surface mount fuseholder especially for telecom applications

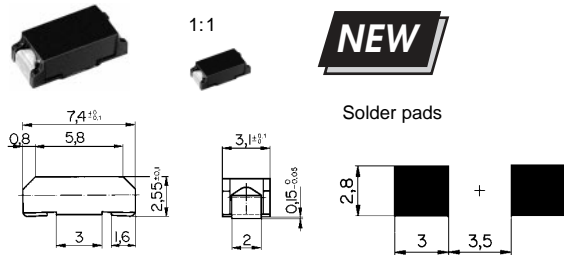

OSU 250 V fuses for surface mounting

can be soldered directly onto printed circuit board or inserted into surface mount fuseholder especially for telecom applications

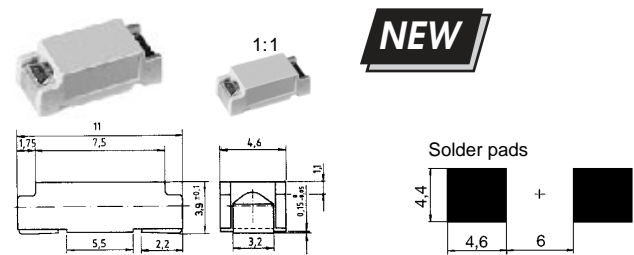

1. Technical data

Series	Pre-arcing time/current characteristic (at T _a 23 °C)						Breaking capacity	Standards
	Rated current I _n	1 · I _n	1,25 · I _n	2 · I _n	4 · I _n	10 · I _n		
		min.	min.	max.	max.	min.	max.	
OSU 125 V	250 mA–3,15 A	4 h	–	1 s	10 ms	–	–	AC 300 A / 125 V p. f. 1 DC 400 A / 125 V UL 248-14 CSA C.22.2 No. 248.14
OSU 250 V	250 mA–3,15 A	–	1 h	IEC/UL 120 s	CSA 60 s	1 ms	10 ms	IEC: L AC 100 A / 250 V p. f. 1 DC 100 A / 250 V IEC 127-4/2 UL 248-14 CSA C.22.2 No. 248.14

2. Order No.



OSU 125 V				ITU-T K.20			UL 1459	GR 1089
Order No.	Rated current I _n Rated voltage U _n	Voltage drop at I _n , typ. mV	Pre-arcing I ² t, typ. A ² s	Fig. 1 Lightning Surge 10x1kV/10/700 μs I _{puls} max.	Fig. 2 Power Induction AC 300 V / 0,5 A 5 x 200 ms	Fig. 3 Power Contact AC 250 V 15 min I _{SC} max.	Fig. 4 AC 600 V 40A / 1,5s 7A / 5s 2,2A / 30 min	Fig. 5 1000 V 50 x 10/1000 μs I _{puls} max.
2060.0006.XX	250 mA / 125 V	990	0,0058	2,5 A	•	50 A		< 1,5 A
2060.0043.XX	350 mA / 125 V	990	0,0076	4 A	•	25 A		< 1,5 A
2060.0044.XX	375 mA / 125 V	990	0,0130	4,6 A	•	25 A		< 1,5 A
2060.0007.XX	400 mA / 125 V	960	0,016	5,8 A	•	25 A		< 1,5 A
2060.0045.XX	500 mA / 125 V	300	0,010	7,7 A	•	25 A		2,5 A
2060.0008.XX	630 mA / 125 V	290	0,020	10 A	•	25 A		4,6 A
2060.0046.XX	750 mA / 125 V	260	0,031	13 A	•	25 A		7 A
2060.0009.XX	1 A / 125 V	220	0,086	16 A	•	25 A		9,3 A
2060.0010.XX	1,25 A / 125 V	220	0,14	25 A	•	25 A		14 A ⁽⁵⁾
2060.0047.XX	1,5 A / 125 V	200	0,24	30 A	•	8,3 A		14 A ⁽⁵⁾
2060.0011.XX	1,6 A / 125 V	200	0,27	33 A	•	12,5 A		14 A ⁽⁵⁾
2060.0012.XX	2 A / 125 V	200	0,44	45 A	•	8,3 A		14 A ⁽⁵⁾
2060.0013.XX	2,5 A / 125 V	190	0,79	67 A ⁽¹⁾	•	8,3 A		14 A ⁽⁵⁾
2060.0014.XX	3 A / 125 V	190	1,1	67 A ⁽¹⁾	•	8,3 A		14 A ⁽⁵⁾
2060.0048.XX	3,15 A / 125 V	190	1,1	67 A ⁽¹⁾	•	8,3 A		14 A ⁽⁵⁾



OSU 250 V				ITU-T K.20			UL 1459	GR 1089
Order No.	Rated current I _n Rated voltage U _n	Voltage drop at I _n , typ. mV	Pre-arcing I ² t, typ. A ² s	Fig. 1 Lightning Surge 10x1kV/10/700 μs I _{puls} max.	Fig. 2 Power Induction AC 300 V / 0,5 A 5 x 200 ms	Fig. 3 Power Contact AC 250 V 15 min I _{SC} max.	Fig. 4 AC 600 V 40A / 1,5s 7A / 5s 2,2A / 30 min	Fig. 5 1000 V 50 x 10/1000 μs I _{puls} max.
2070.0010.XX	250 mA / 250 V	435	0,009	3,9 A	•	100 A		< 1,9 A
2070.0011.XX	315 mA / 250 V	395	0,017	4,3 A	•	100 A		< 1,9 A
2070.0012.XX	400 mA / 250 V	230	0,02	5 A	•	100 A		3,1 A
2070.0013.XX	500 mA / 250 V	190	0,04	10 A	•	100 A		5,1 A
2070.0014.XX	630 mA / 250 V	170	0,08	16 A	•	100 A		9,2 A
2070.0015.XX	800 mA / 250 V	200	0,13	22 A	•	100 A		14 A ⁽⁵⁾
2070.0016.XX	1 A / 250 V	170	0,23	27 A	•	100 A		14 A ⁽⁵⁾
2070.0017.XX	1,25 A / 250 V	150	0,47	43 A	•	100 A		14 A ⁽⁵⁾
2070.0018.XX	1,6 A / 250 V	150	0,84	67 A ⁽¹⁾	•	100 A		14 A ⁽⁵⁾
2070.0019.XX	2 A / 250 V	140	1,4	67 A ⁽¹⁾	•	100 A		14 A ⁽⁵⁾
2070.0020.XX	2,5 A / 250 V	130	2,6	67 A ⁽¹⁾	•	100 A		14 A ⁽⁵⁾
2070.0021.XX	3,15 A / 250 V	130	4,3	67 A ⁽¹⁾	•	100 A		14 A ⁽⁵⁾

Explanation for fig. 1–5 and index ⁽¹⁾ / ⁽⁵⁾: see page 160/161

Packaging see page 167

Surge Tolerant Radial Leaded Fuses

MSU 125 V microfuses

can be soldered directly into printed circuit boards or plugged into fuseholders

especially for telecom applications

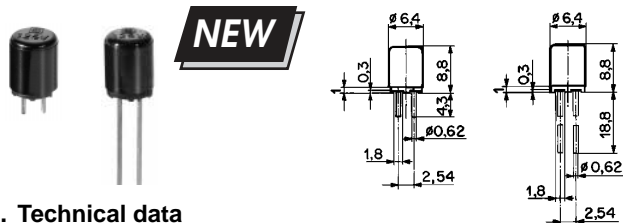

MSU 250 V microfuses

can be soldered directly into printed circuit boards or plugged into fuseholders

especially for telecom applications

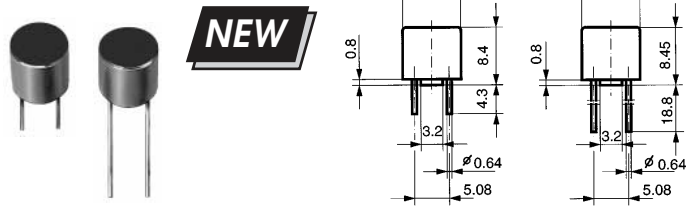

1. Technical data

Series	Pre-arcing time/current characteristic (at T _a 23 °C)											Breaking capacity	Standards	
	Rated current I _n	1 · I _n		1,5 · I _n		2 · I _n		2,75 · I _n		4 · I _n				10 · I _n
		perm.	min.	max.	max.	max.	min.	max.	min.	max.	min.	max.		
MSU 125 V	250 mA–3,15 A	perm.	–	10 min	5 s	–	–	300 ms	–	30 ms	–	4 ms	IEC AC/DC 50 A/125 V p. f. 1 UL/CSA: AC/DC 300 A/125 V p. f. 1	IEC 127-3/1 EN 60127-3/1 UL 248-14 CSA C22.2 No 248.14
MSU 250 V	250 mA–3,15 A	–	60 min	–	–	2 min	400 ms	10 s	150 ms	3 s	20 ms	150 ms	AC 35 A/250 V p. f. 1	IEC 127-3/4 EN 60127-3/4 UL 248-14 CSA C22.2 No 248.14

2. Order No.



MSU 125 V			ITU-T K.20			UL 1459/1950	GR 1089			
Order No.	Rated current I _n	Rated voltage U _n	Voltage drop at I _n , typ.	Pre-arcing I ² t, typ.	Fig. 1 Lightning Surge 10x1kV/10/700 μs I _{puls} max.	Fig. 2 Power Induction AC 300 V/0,5 A 5 x 200 ms	Fig. 3 Power Contact AC 250 V 15 min I _{sc} max.	Fig. 4 AC 600 V 40A / 1,5s 7A / 5s 2,2A / 30 min	Fig. 5 1000 V 50 x 10/1000 μs I _{puls} max.	
Terminals short	long	Taped and reeled	mV	A ² s						
2030.0013	2030.0243	2030.0543	250 mA / 125 V	620	0,006	4,5 A	•	300 A	•	< 1,5 A
2030.0014	2030.0244	2030.0544	315 mA / 125 V	680	0,025	5,6 A	•	300 A	•	< 1,5 A
2030.0015	2030.0245	2030.0545	400 mA / 125 V	180	0,013	5,9 A	•	300 A	•	1,6 A
2030.0016	2030.0246	2030.0546	500 mA / 125 V	180	0,02	6,4 A	•	300 A	•	2,4 A
2030.0017	2030.0247	2030.0547	630 mA / 125 V	180	0,045	7,2 A	•	300 A	•	2,7 A
2030.0018	2030.0248	2030.0548	710 mA / 125 V	140	0,045	7,8 A	•	300 A	•	2,9 A
2030.0019	2030.0249	2030.0549	750 mA / 125 V	170	0,02	8,5 A	•	300 A	•	3 A
2030.0020	2030.0250	2030.0550	800 mA / 125 V	150	0,04	11 A	•	300 A	•	5 A
2030.0021	2030.0251	2030.0551	1 A / 125 V	150	0,07	16 A	•	300 A	•	6 A
2030.0022	2030.0252	2030.0552	1,25 A / 125 V	150	0,12	21 A	•	300 A	•	9,3 A
2030.0023	2030.0253	2030.0553	1,6 A / 125 V	150	0,29	35 A	•	300 A	•	14 A ⁽⁵⁾
2030.0024	2030.0254	2030.0554	2 A / 125 V	130	0,43	38 A	•	300 A	•	14 A ⁽⁵⁾
2030.0025	2030.0255	2030.0555	2,5 A / 125 V	120	0,60	57 A	•	300 A	•	14 A ⁽⁵⁾
2030.0026	2030.0256	2030.0556	3,15 A / 125 V	120	1,11	65 A	•	300 A	•	14 A ⁽⁵⁾



MSU 250 V			ITU-T K.20			UL 1459/1950	GR 1089			
Order No.	Rated current I _n	Rated voltage U _n	Voltage drop at I _n , typ.	Pre-arcing I ² t, typ.	Fig. 1 Lightning Surge 10x1kV/10/700 μs I _{puls} max.	Fig. 2 Power Induction AC 300 V/0,5 A 5 x 200 ms	Fig. 3 Power Contact AC 250 V 15 min I _{sc} max.	Fig. 4 AC 600 V 40A / 1,5s 7A / 5s 2,2A / 30 min	Fig. 5 1000 V 50 x 10/1000 μs I _{puls} max.	
Terminals short	long	Taped and reeled	mV	A ² s						
2040.0609	2040.0709	2040.0809	250 mA / 250 V	120	0,6	25,3 A	•	35 A	•	14 A ⁽⁵⁾
2040.0610	2040.0710	2040.0810	315 mA / 250 V	120	0,8	29,2 A	•	35 A	•	14 A ⁽⁵⁾
2040.0611	2040.0711	2040.0811	400 mA / 250 V	110	1,1	39,5 A	•	35 A	•	14 A ⁽⁵⁾
2040.0612	2040.0712	2040.0812	500 mA / 250 V	100	2,5	57 A	•	35 A	•	14 A ⁽⁵⁾
2040.0613	2040.0713	2040.0813	630 mA / 250 V	90	4	67 A ⁽¹⁾	•	35 A	•	14 A ⁽⁵⁾
2040.0614	2040.0714	2040.0814	800 mA / 250 V	80	8	67 A ⁽¹⁾	•	35 A	•	14 A ⁽⁵⁾
2040.0615	2040.0715	2040.0815	1 A / 250 V	70	12	67 A ⁽¹⁾	•	35 A	•	14 A ⁽⁵⁾
2040.0616	2040.0716	2040.0816	1,25 A / 250 V	70	15	67 A ⁽¹⁾	•	35 A	•	14 A ⁽⁵⁾
2040.0617	2040.0717	2040.0817	1,6 A / 250 V	60	30	67 A ⁽¹⁾	•	50 A	•	14 A ⁽⁵⁾
2040.0618	2040.0718	2040.0818	2 A / 250 V	60	34	67 A ⁽¹⁾	•	50 A	•	14 A ⁽⁵⁾
2040.0619	2040.0719	2040.0819	2,5 A / 250 V	50	55	67 A ⁽¹⁾	•	50 A	•	14 A ⁽⁵⁾
2040.0620	2040.0720	2040.0820	3,15 A / 250 V	50	76	67 A ⁽¹⁾	•	50 A	•	14 A ⁽⁵⁾

Explanation for fig. 1–5 and index ⁽¹⁾ / ⁽⁵⁾: see page 160/161

Packaging see page 167

Packaging Information

MSU 125 V / MSU 250 V

- Packing style
- Packaged loose
 - Taped and reeled 750 pieces
MSU 125 V 1000 pieces

Tape and reel
according to IEC 286-2

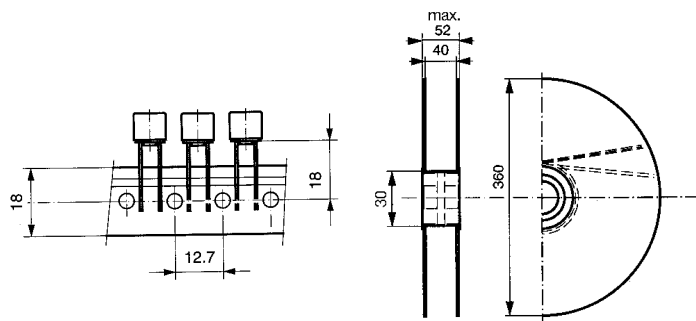

OSU 125 V / OSU 250 V

Packaged loose or blistertaped	OSU 125V	OSU 250V
Packaged loose	2060.XXXX.11	2070.XXXX.11
Blistertape reeled 750 pieces	2060.XXXX.22	
Blistertape reeled 2000 pieces		2070.XXXX.24
Blistertape reeled 3000 pieces	2060.XXXX.24	

Type	Dimensions in mm			
	A	B	C (max.)	D (max.)
OSU 125 V	8	16	18,4	22,4
OSU 250 V	8	24	26,4	30,4

Tape and reel
according to IEC 286-3

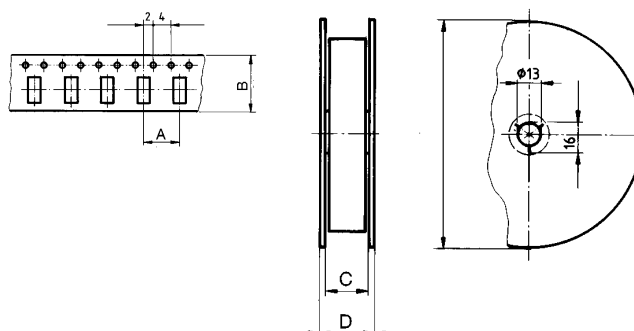

Surge Tolerant Radial Leaded Fuses

FRT 250 T universal modular fuses
especially for telecom applications

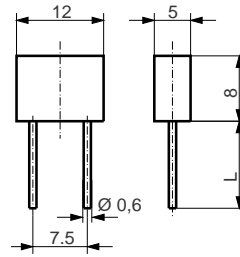
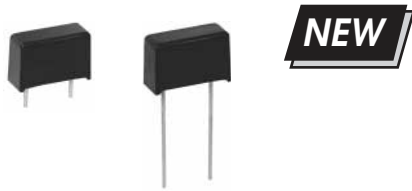

L: short \cong 4,3 mm
long \cong 19 mm
 \varnothing = 0,6 mm

1. Technical data

Series	Pre-arcing time/current characteristic (at T_a 23 °C)					Breaking capacity	Standards
	Rated current I_n	$1,25 \cdot I_n$		$10 \cdot I_n$			
		min.	max.	min.	max.		
FRT 250 T	250 mA–3,15 A	1 h	120 s	10 ms	100 ms	IEC: L AC 100 A/250 V p. f. 0,95	IEC 127-4/1

2. Order No. / Rated currents / Rated voltage Technical data for telecom applications

FRT 250 T			ITU-T K.20				UL 1459/1950	GR 1089			
Order No.	Rated current I_n		Voltage drop at I_n , IEC	Pre-arcing I^2t , typ.	Fig. 1 Lightning Surge 10x1kV/ 5 x 200 ms I_{puls} max.	Fig. 2 Power Induction AC 300 V/0,5A 15 min	Fig. 3 Power Contact AC 250 V 7A / 5s I_{sc} max.	Fig. 4 AC 600 V 40A / 1,5s 1000 μ s 2,2A / 30 min	Fig. 5 1000 V 50 x 10/ I_{puls} max.		
	Terminals short	long								Taped and reeled	typ. \square mV
7100.1009.XX	7100.1109.XX	7100.1109.XX	250 mA / 250 V	800	170	0,32	pend.	pend.	pend.	pend.	
7100.1010.XX	7100.1110.XX	7100.1110.XX	315 mA / 250 V	750	160	0,50	20 A	•	100 A	•	14 A
7100.1011.XX	7100.1111.XX	7100.1111.XX	400 mA / 250 V	700	135	0,80	24 A	•	100 A	•	14 A ⁽⁵⁾
7100.1012.XX	7100.1112.XX	7100.1112.XX	500 mA / 250 V	600	125	1,25	30 A	•	100 A	pend.	14 A ⁽⁵⁾
7100.1013.XX	7100.1113.XX	7100.1113.XX	630 mA / 250 V	500	130	2	46 A	•	100 A	•	14 A ⁽⁵⁾
7100.1014.XX	7100.1114.XX	7100.1114.XX	800 mA / 250 V	400	200	3,20	67 A ⁽¹⁾	•	100 A	•	14 A ⁽⁵⁾
7100.1015.XX	7100.1115.XX	7100.1115.XX	1 A / 250 V	300	180	5	67 A ⁽¹⁾	•	100 A	•	14 A ⁽⁵⁾
7100.1016.XX	7100.1116.XX	7100.1116.XX	1,25 A / 250 V	300	145	7,9	pend.	pend.	pend.	pend.	pend.
7100.1017.XX	7100.1117.XX	7100.1117.XX	1,6 A / 250 V	300	110	12,80	67 A ⁽¹⁾	•	100 A	•	14 A ⁽⁵⁾
7100.1018.XX	7100.1118.XX	7100.1118.XX	2 A / 250 V	300	105	20	67 A ⁽¹⁾	•	100 A	•	14 A ⁽⁵⁾
7100.1019.XX	7100.1119.XX	7100.1119.XX	2,5 A / 250 V	300	140	32	pend.	pend.	pend.	pend.	pend.
7100.1020.XX	7100.1120.XX	7100.1120.XX	3,15 A / 250 V	300	115	50	67 A ⁽¹⁾	•	100 A	•	14 A ⁽⁵⁾
7100.1021.XX	7100.1121.XX	7100.1121.XX	4 A / 250 V	300	120	80	•	•	•	•	•
7100.1022.XX	7100.1122.XX	7100.1122.XX	5 A / 250 V	300	125	125	•	•	•	•	•
7100.1023.XX	7100.1123.XX	7100.1123.XX	6.3 A / 250 V	300	120	200	•	•	•	•	•

Explanation for fig. 1–5 and index ⁽¹⁾ / ⁽⁵⁾: see page 160/161

Packaging

Packaged loose	7100.XXXX.13
Tape and reeled 500 pieces	7100.XXXX.95
Tape and reeled 1000 pieces	7100.XXXX.96

Tape and reel according to IEC 286-2

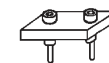

Suitable fuseholder on request

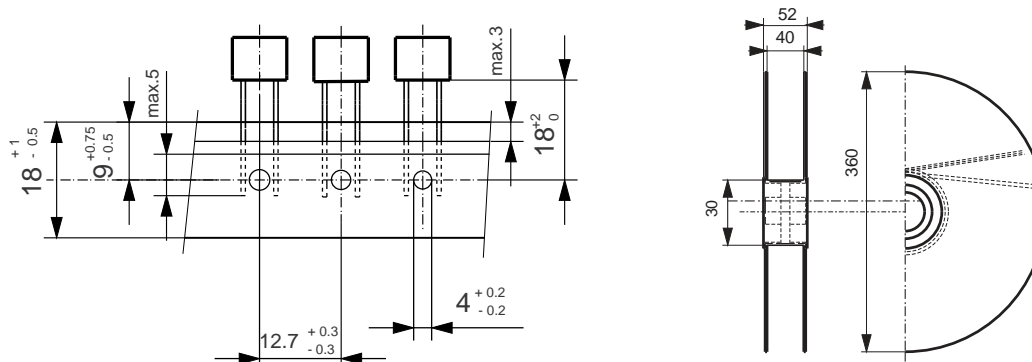

Surge Tolerant Cartridge Fuses

FSU 5 x 20mm fuses
low breaking capacity L

especially for telecom applications

NEW

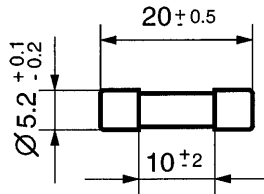

SSU 5 x 20 mm fuses
high breaking capacity H

especially for telecom applications

NEW

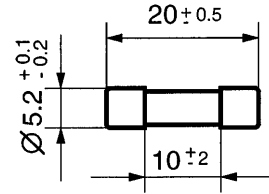

1. Technical data

Series	Pre-arcing time/current characteristic (at T _a 23 °C)									Breaking capacity	Standards
	Rated current I _n	1,5 · I _n		2,1 · I _n		4 · I _n		10 · I _n			
		min.	max.	min.	max.	min.	max.	min.	max.		
FSU 5 x 20	250 mA–3,15 A	60 min	2 min	600 ms	10 s	150 ms	3 s	20 ms	300 ms	IEC/EN: L AC 35 A / 250 V p. f. 1	IEC 127-2/3 EN 60127-2/3
SSU 5 x 20	500 mA–3,15 A	60 min	30 min	1 s	80 s	95 ms	5 s	10 ms	100 ms	IEC/EN: H AC 1500 A / 250 V p. f. 0,7–0,8 UL: AC 10000 A / 125 V p. f. 0,7–0,8 AC 1500 A / 250 V p. f. 0,7–0,8	IEC 127-2/5 EN 60127-2/5

2. Order No.



FSU 5 x 20				ITU-T K.20			UL 1459/1950	GR 1089
Order No.	Rated current I _n Rated voltage U _n	Voltage drop at I _n , typ. mV	Operating I ² t, typ. A ² s	Fig. 1	Fig. 2	Fig. 3	Fig. 4	Fig. 5
				Lightning Surge 10x1kV/10/700 μs I _{puls} max.	Power Induction AC 300 V / 0,5 A 5 x 200 ms	Power Contact AC 250 V 15 min I _{SC} max.	AC 600 V 40A / 1,5s 7A / 5s 2,2A / 30 min	1000 V 50 x 10/1000 μs I _{puls} max.
2010.0011	250 mA / 250 V	210	0,13	16 A	•	100 A	•	14 A ⁽⁵⁾
2010.0012	315 mA / 250 V	170	0,35	27 A	•	100 A	•	14 A ⁽⁵⁾
2010.0013	400 mA / 250 V	150	0,48	35 A	•	100 A	•	14 A ⁽⁵⁾
2010.0014	500 mA / 250 V	160	4,90	67 A ⁽¹⁾	•	100 A	•	14 A ⁽⁵⁾
2010.0015	630 mA / 250 V	160	6,10	67 A ⁽¹⁾	•	100 A	•	14 A ⁽⁵⁾
2010.0016	800 mA / 250 V	120	5,30	67 A ⁽¹⁾	•	100 A	•	14 A ⁽⁵⁾
2010.0017	1 A / 250 V	60	6,70	67 A ⁽¹⁾	•	100 A	•	14 A ⁽⁵⁾
2010.0018	1,25 A / 250 V	60	8,20	67 A ⁽¹⁾	•	100 A	•	14 A ⁽⁵⁾
2010.0065	1,4 A / 250 V	60	7,60	67 A ⁽¹⁾	•	100 A	•	14 A ⁽⁵⁾
2010.0019	1,6 A / 250 V	60	11	67 A ⁽¹⁾	•	100 A	•	14 A ⁽⁵⁾
2010.0020	2 A / 250 V	60	20	67 A ⁽¹⁾	•	100 A	•	14 A ⁽⁵⁾
2010.0021	2,5 A / 250 V	60	24	67 A ⁽¹⁾	•	100 A	•	14 A ⁽⁵⁾
2010.0022	3,15 A / 250 V	60	48	67 A ⁽¹⁾	•	100 A	•	14 A ⁽⁵⁾



SSU 5 x 20				ITU-T K.20			UL 1459/1950	GR 1089
Order No.	Rated current I _n Rated voltage U _n	Voltage drop at I _n , typ. mV	Operating I ² t, typ. A ² s	Fig. 1	Fig. 2	Fig. 3	Fig. 4	Fig. 5
				Lightning Surge 10x1kV/10/700 μs I _{puls} max.	Power Induction AC 300 V / 0,5 A 5 x 200 ms	Power Contact AC 250 V 15 min I _{SC} max.	AC 600 V 40A / 1,5s 7A / 5s 2,2A / 30 min	1000 V 50 x 10/1000 μs I _{puls} max.
2020.0001	500 mA / 250 V	360	0,54	27,7 A	•	1500 A	•	14 A ⁽⁵⁾
2020.0002	630 mA / 250 V	330	1,1	57 A	•	1500 A	•	14 A ⁽⁵⁾
2020.0003	800 mA / 250 V	260	2	67 A	•	1500 A	•	14 A ⁽⁵⁾
2020.0004	1 A / 250 V	180	1,4	57 A	•	1500 A	•	14 A ⁽⁵⁾
2020.0005	1,25 A / 250 V	150	1,8	67 A ⁽¹⁾	•	1500 A	•	14 A ⁽⁵⁾
2020.0006	1,6 A / 250 V	130	4,7	67 A ⁽¹⁾	•	1500 A	•	14 A ⁽⁵⁾
2020.0007	2 A / 250 V	120	9,7	67 A ⁽¹⁾	•	1500 A	•	14 A ⁽⁵⁾
2020.0008	2,5 A / 250 V	100	21	67 A ⁽¹⁾	•	1500 A	•	14 A ⁽⁵⁾
2020.0009	3,15 A / 250 V	100	36	67 A ⁽¹⁾	•	1500 A	•	14 A ⁽⁵⁾

Explanation for fig. 1–5 and index ⁽¹⁾ / ⁽⁵⁾: see page 160/161

• VDE, SEMKO, SEV Approved (1A-3.15A)

Optional pigtail leads

Surge Tolerant Cartridge Fuses

TH1 5x20mm Thermofuses for telecom applications

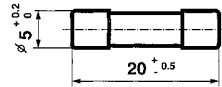

Standards / Approvals
none

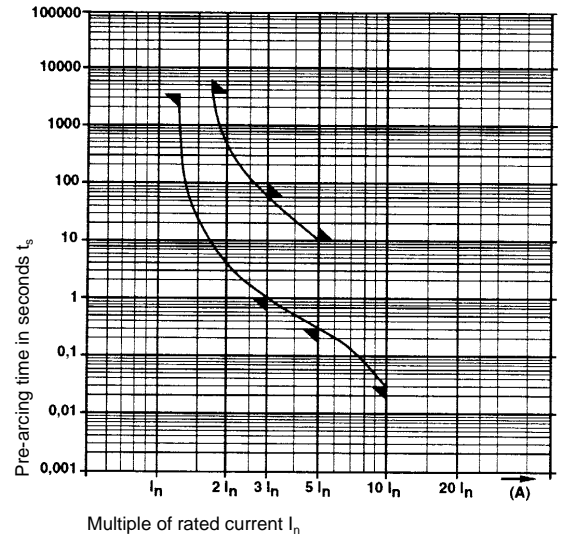

Pre-arcing time/current characteristic (at T_a 23 °C)

Rated current I_n	$1,15 \cdot I_n$		$1,65 \cdot I_n$		$3 \cdot I_n$		$5 \cdot I_n$		$10 \cdot I_n$	
	min.	max.	min.	max.	min.	max.	min.	max.	min.	max.
2,5 A	1 h	1 h	1 s	60 s	0,3 s	10 s	30 ms			

Wave characteristic 8 x 20 μ s according to IEC 60-2

Type	Peak current admissible	
	1 Shock	10 Shocks
Thermolink TH1 / 2,50 A	2,5 kA	2 kA

Technical data

- Resistance up to 8 x 20 μ s current waves (IEC 60-2) of approx 1000 $\cdot I_n$ without degradation
- Interrupting a short-circuit current of approx 1 $\cdot I_n$
- Thermal function: breaking the circuit from 145 °C

Construction	Glass tube
Weight	1,4 g
Climatic range	40 / 070 / 56
Majoration	1,45 $\cdot I_n$ at 40 °C
Minoration	0,7 $\cdot I_n$ at 70 °C
Vibrations	NF C 20-706 / IEC 68-2-6 10-55 Hz / 0,35 mm / 5 cycles
Shocks	NF C 20-727 / IEC 68-2-27, 50 g
Sinusoidal vibrations	NF C 20-729 / IEC 68-2-29, 40 g
Thermal function	160 °C / 100 mA / $t \leq 4000$ s

Order No.	Rated current I_n Rated voltage U_n	Breaking capacity	Voltage drop at I_n mV
7040.2120	AC 2,5 A / 220 V	AC 40 A / 220 V	200

Thermal characteristics without current

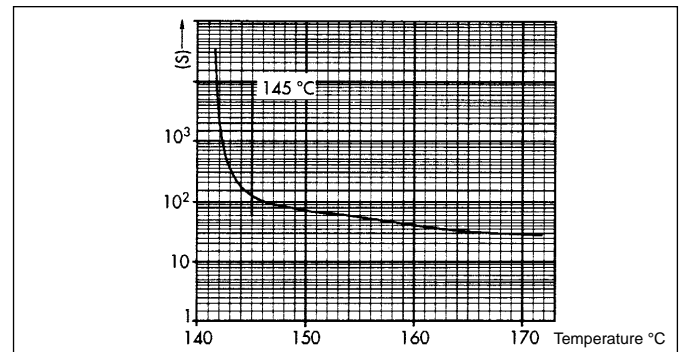

Telecom application example

