

DOC NO	:		Rev.
Issued Date	:	2016/10/21	V2.0
Revised Date	:		

ENGINEERING SPECIFICATIONS

Product Name: DS-8ACSH

Author: Anthony Chien

PLDS
Confidential

DOC NO	:		Rev.
Issued Date	:	2016/10/21	V2.0
Revised Date	:		

History		
1.0	1. First Release	2014/07/21
2.0	1. Disable DVDRAM support	2016/10/21

PLDS
Confidential

DOC NO	:		Rev.
Issued Date	:	2016/10/21	V2.0
Revised Date	:		

TABLE OF CONTENTS

1.	Introduction	5
2.	Features	6
3.	Specifications	7
3.1	Disc type for read/write application	7
3.2	Operation environment for “write/ rewrite” application	8
3.3	Mechanism	9
3.4	Supported Write/Read speed	10
3.5	Supported Write Method	12
3.6	Performance	13
3.7	Error Rate	14
3.8	DVD-ROM Playability	15
3.9	CD-DA Playability	15
3.10	CD-ROM Playability	16
3.11	Environmental Conditions	16
3.12	Reliability	17
3.13	Acoustic Noise	17
3.14	Regulations and Standards	17
3.15	Host Operating System Compatibility	18
3.16	Material	18
3.17	Physical Dimensions	18
3.18	Drive mounting spec	18
3.19	Front Panel	19
3.20	Rear Panel	19
3.21	Disc Eject Mechanism	19
4.	Power Requirements	21
4.1	Power Connectors	21
4.2	SATA Connector Pin Definition	21
4.3	Voltage Requirements	21
4.4	Current Requirements	22
4.5	Power Saving	22
5.	Interface	23
5.1	Interface Connectors	23

DOC NO	:		Rev.
Issued Date	:	2016/10/21	V2.0
Revised Date	:		

5.2	Interface Pin Electrical Parameters	23
5.3	ATA Commands List	24
5.4	ATAPI Commands List	24
6.	Block Diagram	27
7.	Mechanical Drawing	28

PLDS
Confidential

DOC NO	:		Rev.
Issued Date	:	2016/10/21	V2.0
Revised Date	:		

1. INTRODUCTION

This document presents the engineering specifications of Super Dual “DS-8ACSH”, a slim type DVDRW drive. It featuring high speed, power-saving and slim size, is built specifically for notebook computer. The unit measures 12.7 by 128 by 126.1mm and weights below 170g.

DS-8ACSH is a versatile optical disk drive. For CD write function, it is capable to write data, which conforms to Orange Book: Part 2 CD-R Volume 1 / Part 2 CD-R Volume 2 Multi Speed/ Part 3 CD-RW Volume 1 (known as Low Speed) / Part 3 CD-RW Volume2: High Speed / Part3 CD-RW Volume 3: Ultra Speed, into CD-R / RW disk in combination with write application software. For DVD write function, this drive confirms to DVD-RW Version 1.2 / DVD+RW Part 1 Volume 1 Version 1.3 / DVD+RW Part 1 Volume 2 Version 1.0 / DVD-R General Version 2.1 / DVD+R Version 1.3 / DVD-R9 Version 3.01 / DVD+R9 Version 1.2. For read function, it is capable to read all of the following media: DVD single / dual layer (PTP, OTP), DVD-RW, DVD+RW, DVD-R, DVD+R, DVD-R9, DVD+R9. Besides, it reads all of CD formats and media: CD-DA, CD-ROM, CD-ROM/XA, Photo-CD, Multi-session, Karaoke-CD, Video CD, CD-I FMV, CD Extra, CD Plus, CD-TEXT, CD-R and CD-RW.

The drive supports a DVD-ROM data transfer rate of 8X in the outer track, 3.3X in the inner track, and achieves 6X speed in average for a 12cm (4.7Gbyte, single layer) disc. For CD-ROM data transfer rate, it supports 24X in the outer track, 10X in the inner track, and achieves 19X speed in average for a 74 min disc. Besides, **SMART-X** function smartly adjusts CD-DA / VCD / DVD data extraction to a fastest allowable speed according to both data request rate from host and disk quality. Regarding to CD write speed, it supports CD-R 24X writing, CD-RW 24X re-writing/ DVD-RW 6X re-writing / DVD+RW 8X re-writing / DVD-R 8X writing / DVD+R 8X writing / DVD-R9 6X writing / DVD+R9 6X writing. For writing/ rewriting, **SMART-BURN**[®] function can avoid buffer under run as well as get the best writing quality by smartly adjusting writing strategy.

DS-8ACSH is a multi-function drive with power saving, slim size and ultra light weight that it meets notebook computer as well as all kinds of compact or external applications.

DOC NO	:		Rev.
Issued Date	:	2016/10/21	V2.0
Revised Date	:		

2. FEATURES

1. 12.7mm height for notebook computer use
2. High efficient power saving modes and ACPI compliant
3. Fast access time and high data transfer rate, could be vertical mounted (optional)
4. Max. 24X CD-ROM CAV (Constant Angular Velocity) reading
5. Max. 24X CD-R PCAV writing
6. Max. 24X CD-RW ZCLV rewriting
7. Max. 8X DVD-ROM CAV reading
8. Max. 6X DVD-RW ZCLV rewriting
9. Max. 8X DVD+RW ZCLV rewriting
10. Max. 8X DVD-R PCAV writing
11. Max. 8X DVD+R PCAV writing
12. Max. 6X DVD-R9 PCAV writing
13. Max. 6X DVD+R9 PCAV writing
14. **SMART-X** Smart Monitoring & Adjusting Read-speed Technology for eXtraction
15. **SMART-BURN**[®] Smart Monitoring & Adapting Recording Technology for Burning
16. Buffer under run free
17. Conform to Orange Book: Part 2 CD-R Volume 1, Part 2 CD-R Volume 2 Multi Speed, Part 3 CD-RW Volume 1 (1x, 2x, and 4x), Part 3 CD-RW Volume2: High Speed, Part 3 CD-RW Volume 3: Ultra Speed. Support Fixed packet, Variable packet, Disc-at-once, Session-at-once and Track-at-once
18. Support Over-Burn and Raw mode copy
19. CD read compliant: CD-DA, CD-ROM, CD-ROM/XA , Photo-CD, Multi-session, Video-CD, CD-I FMV, CD Extra, CD Plus, CD-R , and CD-RW discs of 8 or 12 cm diameter
20. DVD read compliant: DVD single / dual layer (PTP, OTP), DVD-RW, DVD+RW, DVD-R, DVD-R multi-borders, DVD+R, DVD+R multi-sessions, DVD-R9, DVD+R9 discs with diameter of 8 or 12 cm
21. Support DOS 6.xx, XP / 2003 / Vista / Win7 / Win8 / Win8.1/ Win10 and Linux operating system
22. Serial ATA Revision 3.1, ATA-8, MMC-6, SFF-8090 V8, and IMAPI compliant
23. MPC level 3, PC2001 System Design Guide, MultiRead/UDF compliant
24. 3 tray-eject methods – eject button, software, and emergency eject
25. Supported transfer mode: Ultra DMA mode 6
26. MTBF 60,000 POH
27. Flash ROM support on line programming capability
28. Support RPC II (Region Playback Control)

DOC NO	:		Rev.
Issued Date	:	2016/10/21	V2.0
Revised Date	:		

3. SPECIFICATIONS

3.1 Disc type for read/write application

Applicable Formats	CD-DA, CD-TEXT, CD ROM Mode-1, CD-ROM/XA Mode-2 Form-1 and Form-2, CD-I Ready, Video-CD (MPEG-1), Photo-CD, Enhance CD, CD extra, UDF (fixed/variable Packet mode), DVD-ROM, DVD-Video, DVD-Audio, DVD-RW DVD+RW DVD-R single/multi border(s) DVD+R single/multi session(s) DVD-R9 single/multi border(s) DVD+R9 single/multi session(s)
Applicable Media Type	CD-ROM, CD-R and CD-RW DVD-ROM (4.7G/8.54G) single layer on single/double side (Read Only), DVD-ROM dual layer (PTP/OTP) on single/double side, (Read Only) DVD-RW, DVD+RW, DVD-R (4.7G for General), DVD+R, DVD+R9, DVD-R9
Disc Diameter	12cm and 8cm
Capacity	2,048 bytes/sector (DVD) 2,048 bytes/block (CD Mode-1 and Mode-2 Form-1), 2,336 bytes/block (Mode-2) 2,328 bytes/block (Mode-2 Form-2) 2352 bytes/block (CDDA)

DOC NO	:		Rev.
Issued Date	:	2016/10/21	V2.0
Revised Date	:		

3.2 Operation environment for “write/ rewrite” application

OS	DOS 6.xx, XP / 2003 / Vista / Win7 / Win8 / Win8.1 / Win10 and Linux operating system
Hard disk	Empty Storage Capacity: 100 MB or more Average access time: 20 ms or less
Disc Diameter (Capacity)	8cm and 12cm
Recommended Media	<p>CD-R: CMC ,MBI, MCC, NANYA, PLASMON, PRODISC, RITEK, SONY, TDK, TY</p> <p>Low Speed CD-RW: CMC, INFODISC, MCC, RITEK</p> <p>High Speed CD-RW: CMC, INFODISC, MBI, MCC, RICOH</p> <p>Ultra Speed CD-RW: MCC,</p> <p>DVD-RW : CMC, JVC, MKM, RITEK, TDK</p> <p>DVD+RW : CMC, MBI, MKM, PHILIPS, RICOH, RITEK</p> <p>DVD-R : CMC, MAXELL, MKM, PRODISC, RITEK, SONY, TDK, TY</p> <p>DVD+R : MAXELL, MBI, MKM, PRODISC, RITEK, SONY, TDK, TY</p> <p>DVD-R9 : CMC, MKM, RITEK, TY</p> <p>DVD+R9 : CMC, MKM, RICOH, RITEK</p>

DOC NO	:		Rev.
Issued Date	:	2016/10/21	V2.0
Revised Date	:		

3.3 Mechanism

Item	Specification
Pick-up	<p>NA: CD: 0.51 DVD: 0.66</p> <p>Focusing: CD: Differential Astigmatism(DAD) DVD: Differential Astigmatism(DAD)</p> <p>Tracking: CD: DPP DVD-ROM: DPD DVD+R/RW:DPP DVD-R/RW:DPP</p> <p>Wave length: CD: 785 nm (Typical) DVD: 661 nm (Typical)</p> <p>Output writing power: CD: CW ... more than 45.4mW (LD_Po=160mW(CD) at 25°C) Pulse ... more than 93.1mW (Pulse width : 50 ns or less, Duty : 50%)</p> <p>DVD: CW ... more than 24.2mW/CW (LD_Po=90mW(DVD) at 25°C) Pulse ... more than 90.3mW (Pulse width : 30 ns or less, Duty : 35%)</p>
Traverse mechanism	DC Stepping motor driven
Spindle motor	DC brushless motor
Loading mechanism	Sled driving latch/eject mechanism

DOC NO	:	Rev.
Issued Date	: 2016/10/21	V2.0
Revised Date	:	

3.4 Supported Write/Read speed

Media type for write	Write speed selected	Disc spin method for write
CD-R	10X / 16X / 20X / 24X	10X CLV 16X/20X/24X PCAV
Low speed CD-RW	4X	4X CLV
High speed CD-RW	10X	10X CLV
Ultra speed CD-RW	10X / 16X / 20X / 24X	10X CLV 16X/20X/24X ZCLV
Ultra ⁺ speed CD-RW	10X / 16X / 20X / 24X	10X CLV 16X/20X/24X ZCLV
DVD-RW	2X / 3X / 4X / 6X	2X/3X CLV 4X/6X ZCLV
DVD+RW	2.4X / 3X / 4X / 7X / 8X	2.4X/3X CLV 4X/7X/8X ZCLV
DVD-R	2X / 3X / 4X / 6X / 8X	2X/3X CLV 4X/6X/8X PCAV
DVD+R	2.4X / 3X / 4X / 6X / 8X	2.4X/3X CLV 4X/6X/8X PCAV
DVD-R Double Layer	3X / 4X / 6X	3X CLV 4X/6X PCAV
DVD+R Double Layer	2.4X / 3X / 4X / 6X	2.4X/3X CLV 4X/6X PCAV

Confidential

DOC NO	:	Rev.
Issued Date	: 2016/10/21	V2.0
Revised Date	:	

Read (or data extraction for copy)	CLV	CAV
DVD-ROM (single layer)		1.2~3X, 1.6~4X, 2.4~6X, 3.3~8X
DVD-ROM (dual layer)		1.2~3X, 1.6~4X, 2.4~6X, 3.3~8X
DVD+R		1.2~3X, 1.6~4X, 2.4~6X, 3.3~8X
DVD+RW		1.2~3X, 1.6~4X, 2.4~6X, 3.3~8X
Double layer DVD+R		1.2~3X, 1.6~4X, 2.4~6X, 3.3~8X
Double layer DVD-R		1.2~3X, 1.6~4X, 2.4~6X, 3.3~8X
DVD-R		1.2~3X, 1.6~4X, 2.4~6X, 3.3~8X
DVD-RW		1.2~3X, 1.6~4X, 2.4~6X, 3.3~8X
CD-ROM, Finalized CD-R, CD-RW		4.1~10X, 6.7~16X, 8.3~20X, 10~24X
Data		4.1~10X, 6.7~16X, 8.3~20X, 10~24X
CD-DAE		4.1~10X, 6.7~16X, 8.3~20X, 10~24X
Video CD		4.1~10X, 6.7~16X, 8.3~20X, 10~24X
Unfinalized CD-R/RW		10~24X
Play	CLV	CAV
Video CD		6.7X~16X
CD-DA		4.1X~10X
DVD single/ dual layer		1.6X~4X

DOC NO	:		Rev.
Issued Date	:	2016/10/21	V2.0
Revised Date	:		

3.5 Supported Write Method

Following write methods are supported by this drive on following media

<Characteristics pertaining to CD-R/RW>

- Uninterrupted Write
 - Disc at Once
- Incremental Write [including Multi-session]
 - Track at Once
 - Session at Once
 - Fixed Packet
 - Variable Packet

<Characteristics pertaining to DVD-RW>

- Disc at Once Recording
- Incremental Recording
- Restricted Overwrite

<Characteristics pertaining to DVD+RW>

- Random Access Write

<Characteristics pertaining to DVD-R>

- Disc at Once Recording
- Incremental Recording

<Characteristics pertaining to DVD+R/DVD+R9>

- Incremental Write

<Characteristics pertaining to DVD-R9>

- Disc-At-Once (un-interrupted)
- Incremental
- Layer Jump

3.6 Performance

Item	Min	Typical (Avg.)	Max
Data Buffer (MB)			0.5
Burst Data Transfer Rate (MB/s)			150
Sustained Data Transfer Rate (KB/s)			
CD-ROM inside ¹	1,450		
CD-ROM outside ²	3,500		
DVD-ROM inside ³	3,700		
DVD-ROM outside ⁴	10,000		

¹ Test disc: ABEX TCDR-704 @00 min 02 sec 00 block

² Test disc: ABEX TCDR-704 @73 min 00 sec 00 block

³ Test disc: ABEX TDR-820B @ 0X00

⁴ Test disc: ABEX TDR-820B @ 0X22F000

DOC NO	:		Rev.
Issued Date	:	2016/10/21	V2.0
Revised Date	:		

Access Time (ms)			
CD 1/3 Stroke ⁵		130	185
Random Access ⁶		130	185
Full Stroke ⁷		250	330
DVD 1/3 Stroke ⁸		130	185
Random Access ⁹		130	185
Full Stroke ¹⁰		250	330
Start Up Time ¹¹ (sec)			
CD			16
DVD			16
Stop Time ¹² (sec)			
CD			8
DVD			8
Spindle (sec)			
Spin Up Time			5.0
Spin Down Time			5.0

⁵ It is computed by averaging 100 or more measures of the access time from 24 min 00 sec 00 block to 48 min 00 sec 00 block, including latency and error correction time. Test Disc: A-BEX TCDR-704

⁶ It is computed by averaging 100 or more measures of the access time from 0 min 02 sec 00 block to 73 min 00 sec 00 block, including latency and error correction time. Test Disc: A-BEX TCDR-704

⁷ It is computed by averaging 100 or more measures of random access time from 0 min 02 sec 00 block to 73 min 00 sec 00 blk, including latency and error correction time. Test Disc: A-BEX TCDR-704

⁸ It is computed by averaging 100 or more measures of the access time from 0XBA550 to 0X174AA0, including latency and error correction time. Test Disc: A-BEX TDR-820B

⁹ It is computed by averaging 100 or more measures of the access time from 0X00 to 0X22F000, including latency and error correction time. Test Disc: A-BEX TDR-820B

¹⁰ It is computed by averaging 100 or more measures of random access time from 0X00 to 0X22F000, including latency and error correction time. Test Disc: A-BEX TDR-820B

¹¹ It includes spin up and read TOC Test Disc: A-BEX TCDR-704 CD / TDR-820B DVD

¹² It includes spin down and tray eject

DOC NO	:		Rev.
Issued Date	:	2016/10/21	V2.0
Revised Date	:		

3.7 Error Rate

For CD-ROM

Mode-1 (ECC on) 10^{-12} Block/Bit

Mode-2 (ECC off) 10^{-9} Block/Bit

For DVD-ROM 10^{-15} Block/Bit

3.8 DVD-ROM Playability

Item		Min.
Scratch	(mm)	2.0
Interruption	(mm)	0.8
Black Dot	(mm)	0.8
Fingerprint	(μ m)	65
Eccentric	(μ m)	100
Vertical Deviation	(mm)	0.8
Unbalance	(g-mm)	2.5 (Max. speed)
		5 (Down speed)
		10 (Down speed)

Note: No read error in the above tests

3.9 CD-DA Playability

Item		Min.
Scratch	(mm)	1.4
Black Dot	(mm)	0.8
Fingerprint	(μm)	65
Eccentric	(μm)	210
Vertical Deviation	(mm)	0.8
Unbalance	(g-mm)	2.5 (Max. speed)
		5 (Down speed)
		10 (Down speed)

Note: No track jump in the above tests

3.10 CD-ROM Playability

Item		Min.
Scratch	(mm)	2.0
Black Dot	(mm)	0.8
Fingerprint	(μm)	65
Eccentric	(μm)	210
Vertical Deviation	(mm)	0.8
Unbalance	(g-mm)	2.5 (Max. speed)
		5 (Down speed)
		10 (Down speed)

Note: No read error in the above tests.

DOC NO	:		Rev.
Issued Date	:	2016/10/21	V2.0
Revised Date	:		

3.11 Environmental Conditions

Ambient Temperature (Non-Condensation)

Operating	5°C to 50°C(30°C per hour max)
Non-Operating	-40°C to 65°C(30°C per hour max)

Relative Humidity (Non-Condensation)

Operating	10% to 80% RH(20% per hour max)
Non-Operating	10% to 90% RH(20% per hour max)

Shock (11msec half-sine, 6 sec between shocks, 20 times per axis (X, Y and Z))

Operating	6 G (CD/DVD-ROM, No damage, No read error)
	4 G (CD-DA, no track jump)
	4 G (Write, no write error)

Shock (1 times per face, total 6 faces)

Non-Operating (with disk)	400 G (2msec half-sine, No damage)
	140 G (180 In/sec square wave, No damage)

Random Vibration from 10 to 500 Hz, 90sec / axis.

Operating	1.0 g RMS (CD-DA, no track jump)
Operating	1.0 g RMS (CD/ DVD-ROM, no read error)
Operating	0.7 g RMS (CD Recordable, no write/rewrite error)
Operating	0.7 g RMS (DVD Recordable, no write/rewrite error)

Random vibration from 5 to 800 Hz, 30 min per axis (X, Y and Z)

Non-Operating (with disc)	3.94g RMS, (No damage)
---------------------------	------------------------

Altitude

Operating	0 ~ 10,000 feet (3,048 m)
Non-Operating	0 ~ 35,000 feet (10,600 m)

3.12 Reliability

MTBF	60,000 POH at 25% duty cycle in 40° C ambient temperature Power on hours per year for an optical drive is defined as 2500 hours.
------	---

DOC NO	:		Rev.
Issued Date	:	2016/10/21	V2.0
Revised Date	:		

MTTR	30 minutes
Loading Operation	20,000 cycles
Actuator Mechanism	1,000,000 full stroke seeks
ElectroStatic Discharge Susceptibility (330Ω, 150pF)	±4 KV (Contact Discharge) No read/write/rewrite error ±6 KV (Contact Discharge) No play error ±8 KV (Contact Discharge) No damage ±8 KV (Air Discharge) No read/write/rewrite error ±12 KV (Air Discharge) No play error ±15 KV (Air Discharge) No damage

3.13 Acoustic Noise

Sound pressure (sequential/random read) under 47 dB (follow ISO-7779, bare drive)
Playing A-BEX 3g-mm unbalance CD/DVD media

3.14 Regulations and Standards

Safety

UL	cUL60950
TUV	EN60950, EN60825-1
CB- Scheme	IEC60950, IEC60825-1

EMC

FCC (USA)	FCC CFR 47 Part 15 Class B, CISPR22, ANSI C63.4
CE (European)	EN55022, EN55024, EN61000, IEC61000
C-Tick(Austria)	AS/NZS CISPR22
BSMI (Taiwan)	CNS13438(C6357)
KCC (Optional)	KN61000

Laser Safety

DHHS (USA)	21CFR Subchapter J
------------	--------------------

3.15 Host Operating System Compatibility

DOS 6.xx or higher
XP / 2003 / Vista / WIN 7 / WIN 8 / Win8.1 / Win10
Linux

DOC NO	:		Rev.
Issued Date	:	2016/10/21	V2.0
Revised Date	:		

4. MECHANICAL

4.1 Material

The front bezel, push button and tray lid are modeled. Additional specifications of these components are described in the following table.

ITEMS	Front Bezel/Button/Door	Tray	Rail L&R
Material	PC/ABS C6200	PC	PPS
Flammability	UL94V0	UL94V2	UL94V2

4.2 Physical Dimensions

Height	12.7 +/-0.2 mm (without Label)
Width	128 +/-0.2 mm
Depth	126.1 +/-0.2 mm (without bezel)
Weight	170 g Max (without bezel)

4.3 Drive mounting spec

Mount the drive horizontally within $\pm 10^\circ$ tilt.

Mounting screw:	M2
Recommended screw length:	user defined
Max. Screw length into drive:	(See ME drawing for detail)

DOC NO	:		Rev.
Issued Date	:	2016/10/21	V2.0
Revised Date	:		

4.4 Front Panel

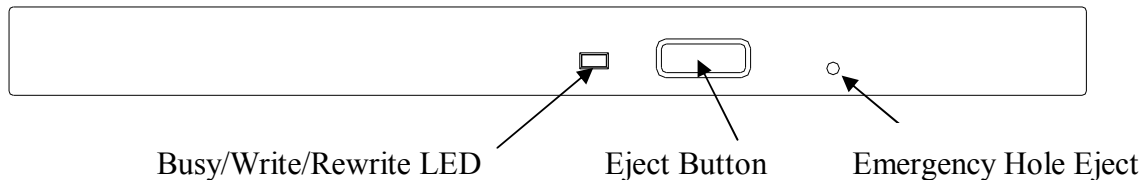

Busy/Write/Rewrite LED

Indication of drive's operation status: Busy / Write/ Rewrite.

Eject button

Push button to eject the tray.

Emergency hole eject

To eject the locked tray caused by loss of power.

4.5 Rear Panel

The rear panel of the drive has a 13 pin SATA connector. The following layout illustrates the rear panel.

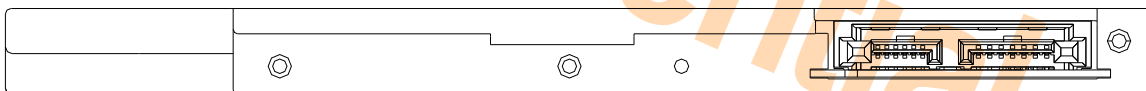

4.6 Disc Eject Mechanism

The drive can eject the disc by any one of the following three methods.

Stop/Eject Button

When the power is on, the user can push this key to eject the tray.

Software Eject

The tray can be ejected by commands from the host computer.

Pin Hole Eject

A pin hole eject mechanism is available on the front bezel to eject the disc in an emergency

DOC NO	:		Rev.
Issued Date	:	2016/10/21	V2.0
Revised Date	:		

situation. To eject a disc manually, insert a steel rod with 1.2 mm (Max.) in diameter into this emergency eject hole and push softly. The rod must be inserted into the drive at least 10 mm from the surface of bezel for 2.0 mm thickness bezel.

PLDS
Confidential

DOC NO	:	Rev.
Issued Date	: 2016/10/21	V2.0
Revised Date	:	

5. POWER REQUIREMENTS

5.1 Power Connectors

There is a 13 pin SATA connector Molex 47300-1020 or compatibles on the rear panel as the diagram below. The required power can be fed into CD-ROM drive through some pins in this connector.

Connector Molex SD-47300-1001

Power Pin 1

Signal Pin 1

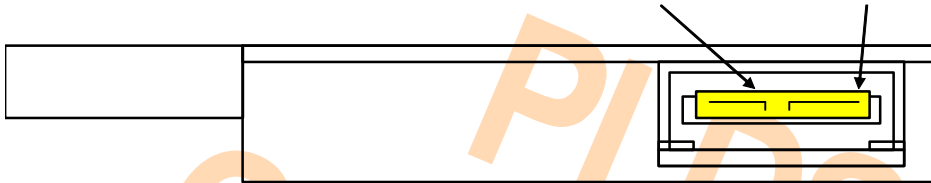

5.2 SATA Connector Pin Definition

Signal Segment	S1	Gnd	
	S2	A+	Differential signal pair from host controller.
	S3	A-	
	S4	Gnd	
	S5	B-	Differential signal pair to host controller.
	S6	B+	
	S7	Gnd	

Power Segment	P1	DP	Device Present
	P2	+5V	
	P3	+5V	
	P4	MD	Manufacturing Diagnostic
	P5	Gnd	
	P6	Gnd	

5.3 Voltage Requirements

+5V : $\pm 5\%$ and less than 100 mVp-p ripple voltage from 10Hz to 10MHz

DOC NO	:		Rev.
Issued Date	:	2016/10/21	V2.0
Revised Date	:		

5.4 Current Requirements

	<u>Average.</u>	<u>Max.</u>
Spindle motor startup	--	1300 mA (Spikes less 2ms)
Tray eject at max speed	--	1300 mA (Spikes less 2ms)
Continuous read at max speed	900 mA	--
Continuous write at max speed	900 mA	--
Random access at max speed	900 mA	--
Idle (laser on, motor on)	600 mA	--
Standby (laser off, motor off, DIPM on)	40 mA	--
Sleep (minimum current, DIPM on)	40 mA	--

5.5 Power Saving

The drive provides the power saving function, which is compliant with the EPA energy star standard.

DOC NO	:	Rev.
Issued Date	: 2016/10/21	V2.0
Revised Date	:	

6. INTERFACE

The interface is based on Serial ATA 2.6 (High Speed Serialized AT Attachment Revision 2.6), and SFF-8090i Rev. 7 (Mt. Fuji Commands for Multimedia Devices)

6.1 Interface Connectors

In the same connector Molex 47300-1020 or compatible connector on the rear panel, this drive and host system can transfer commands and data through this connector.

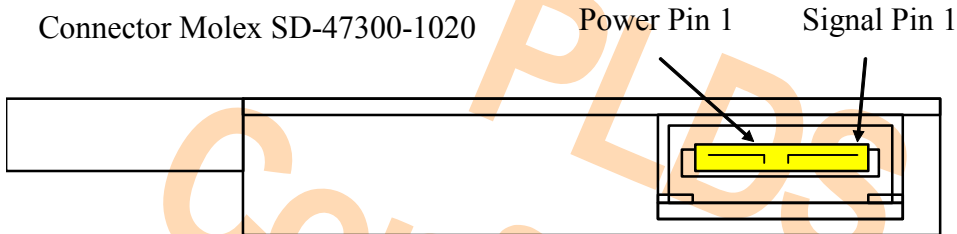

6.2 Interface Pin Electrical Parameters

Items	Min	Max
I _{oL} Driver sink current	4 mA	
I _{oH} Drive source current	-400 μ A	
V _{iH} Voltage input high	2.0 V D.C.	
V _{iL} Voltage input low		0.8 V D.C.
V _{oH} Voltage output high	2.4 V D.C.	
V _{oL} Voltage output low		0.5 V D.C.

6.3 ATA Commands List

Code	Command	Type
00h	NOP	Mandatory
08h	DEVICE RESET	Mandatory
20h	READ SECTOR	Mandatory
90h	EXECUTE DEVICE DIAGNOSTIC	Mandatory
A0h	PACKET	Mandatory
A1h	IDENTIFY PACKET DEVICE	Mandatory
E0h	STANDBY IMMEDIATE	Mandatory
E1h	IDLE IMMEDIATE	Mandatory
E2h	STANDBY	Optional
E3h	IDLE	Optional
E5h	CHECK POWER MODE	Mandatory
E6h	SLEEP	Mandatory
E7h	FLUSH CACHE	Mandatory
ECh	IDENTIFY DEVICE	Mandatory
EFh	SET FEATURES	Mandatory

6.4 ATAPI Commands List

Code	Command	Type
00h	TEST UNIT READY	Mandatory
01h	ZERO UNIT	Mandatory
03h	REQUEST SENSE	Mandatory
04h	FORMATE UNIT	Mandatory
12h	INQUIRY	Mandatory
1Bh	START STOP UNIT	Mandatory
1Eh	PREVENT/ALLOW MEDIUM REMOVAL	Mandatory
23h	READ FORMAT CAPACITY	Mandatory
25h	READ CAPACITY	Mandatory
28h	READ (10)	Mandatory
2Ah	WRITE	Mandatory
2Bh	SEEK	Mandatory

DOC NO	:		Rev.
Issued Date	:	2016/10/21	V2.0
Revised Date	:		

2Eh	WRITE AND VERIFY (10)	Optional
2Fh	VERIFY (10)	Optional
35h	SYNCHRONIZE CACHE	Mandatory
3Bh	WRITE BUFFER	Mandatory
3Ch	READ BUFFER	Mandatory
42h	READ SUB-CHANNEL	Mandatory
43h	READ TOC/PMA/ATIP	Mandatory
44h	READ HEADER	Mandatory
45h	PLAY AUDIO (10)	Mandatory
46h	GET CONFIGURATION	Mandatory
47h	PLAY AUDIO MSF	Mandatory
4Ah	GET EVENT STATUS NOTIFICATION	Mandatory
4Bh	PAUSE/RESUME	Mandatory
4Eh	STOP PLAY / SCAN	Mandatory
51h	READ DISC INFORMATION	Mandatory
52h	READ TRACK INFORMATION	Mandatory
53h	RESERVE TRACK	Mandatory
54h	SEND OPC INFORMATION	Mandatory
55h	MODE SELECT (10)	Mandatory
58h	REPAIR TRACK	Mandatory
5Ah	MODE SENSE (10)	Mandatory
5Bh	CLOSE TRACK SESSION	Mandatory
5Ch	READ BUFFER CAPACITY	Mandatory
5Dh	SEND CUE SHEET	Mandatory
A1h	BLANK	Mandatory
A2h	SEND EVENT	Mandatory
A3h	SEND KEY	Mandatory
A4h	REPORT KEY	Mandatory
A5h	PLAY AUDIO (12)	Mandatory
A7h	SET READ AHEAD	Mandatory
A8h	READ (12)	Mandatory
AAh	WRITE(12)	Mandatory

DOC NO	:		Rev.
Issued Date	:	2016/10/21	V2.0
Revised Date	:		

ACh	GET PERFORMANCE	Mandatory
ADh	READ DVD STRUCTURE	Mandatory
B6h	SET STREAMING	Mandatory
B9h	READ CD MSF	Mandatory
BBh	SET CD SPEED	Optional
BDh	MECHANISM STATUS	Mandatory
BEh	READ CD	Mandatory
BFh	SEND DVD STRUCTURE	Mandatory

PLDS
Confidential

DOC NO	:	Rev.
Issued Date	: 2016/10/21	V2.0
Revised Date	:	

7. BLOCK DIAGRAM

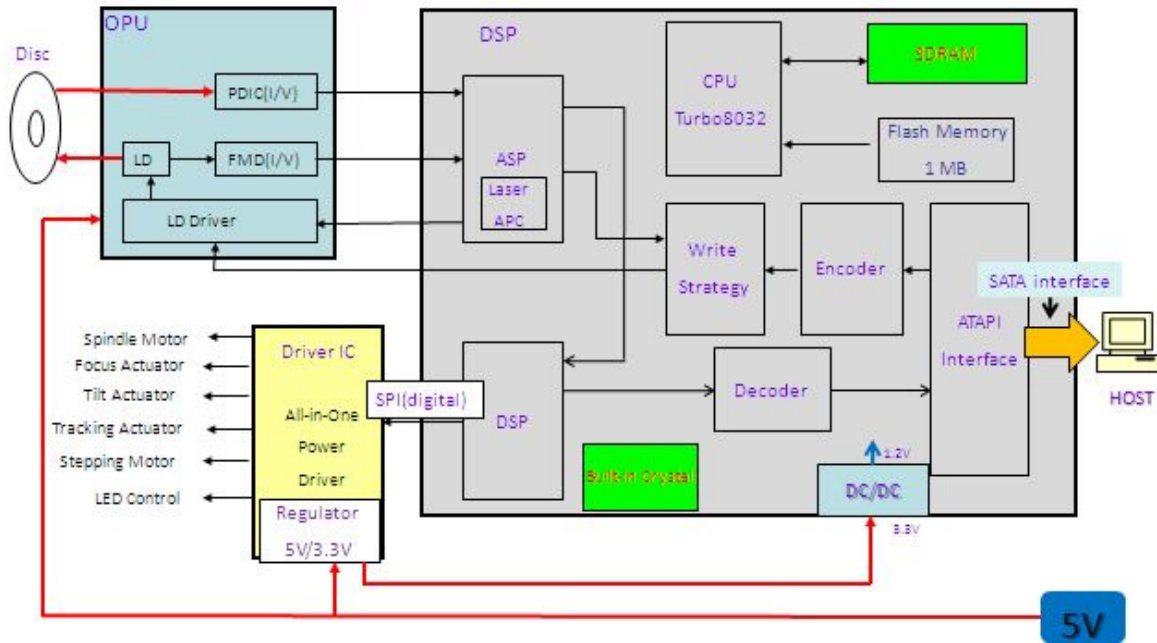

DS-8ACSH Block Diagram

Confidential

DOC NO	:		Rev.
Issued Date	:	2016/10/21	V2.0
Revised Date	:		

8. MECHANICAL DRAWING

Outline Drawing (With Bezel)

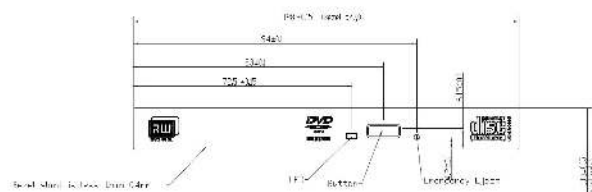
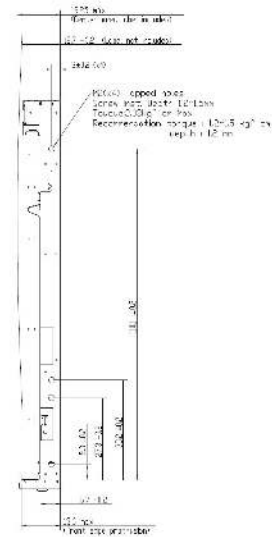
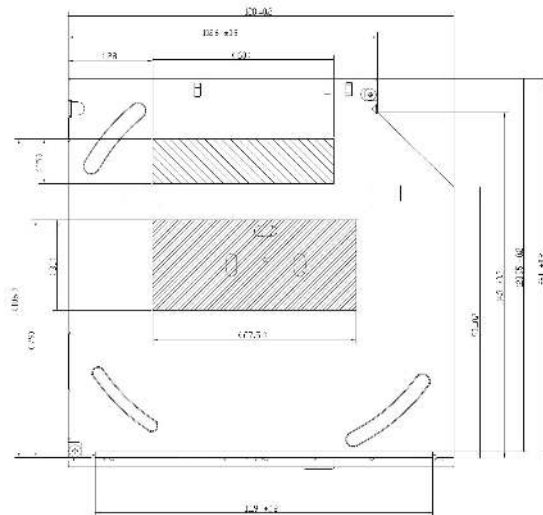
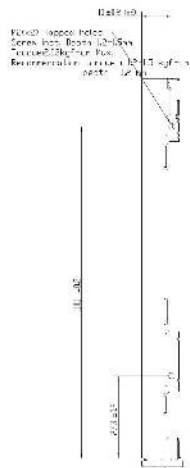
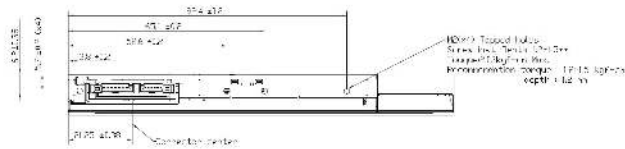
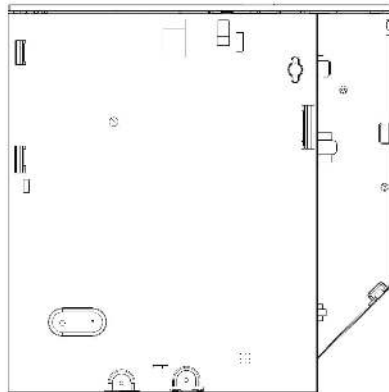

Safety Label Area
 Serial Number Label Area

DOC NO	:	Rev.
Issued Date	:	2016/10/21
Revised Date	:	V2.0

Outline Drawing (Without Bezel)

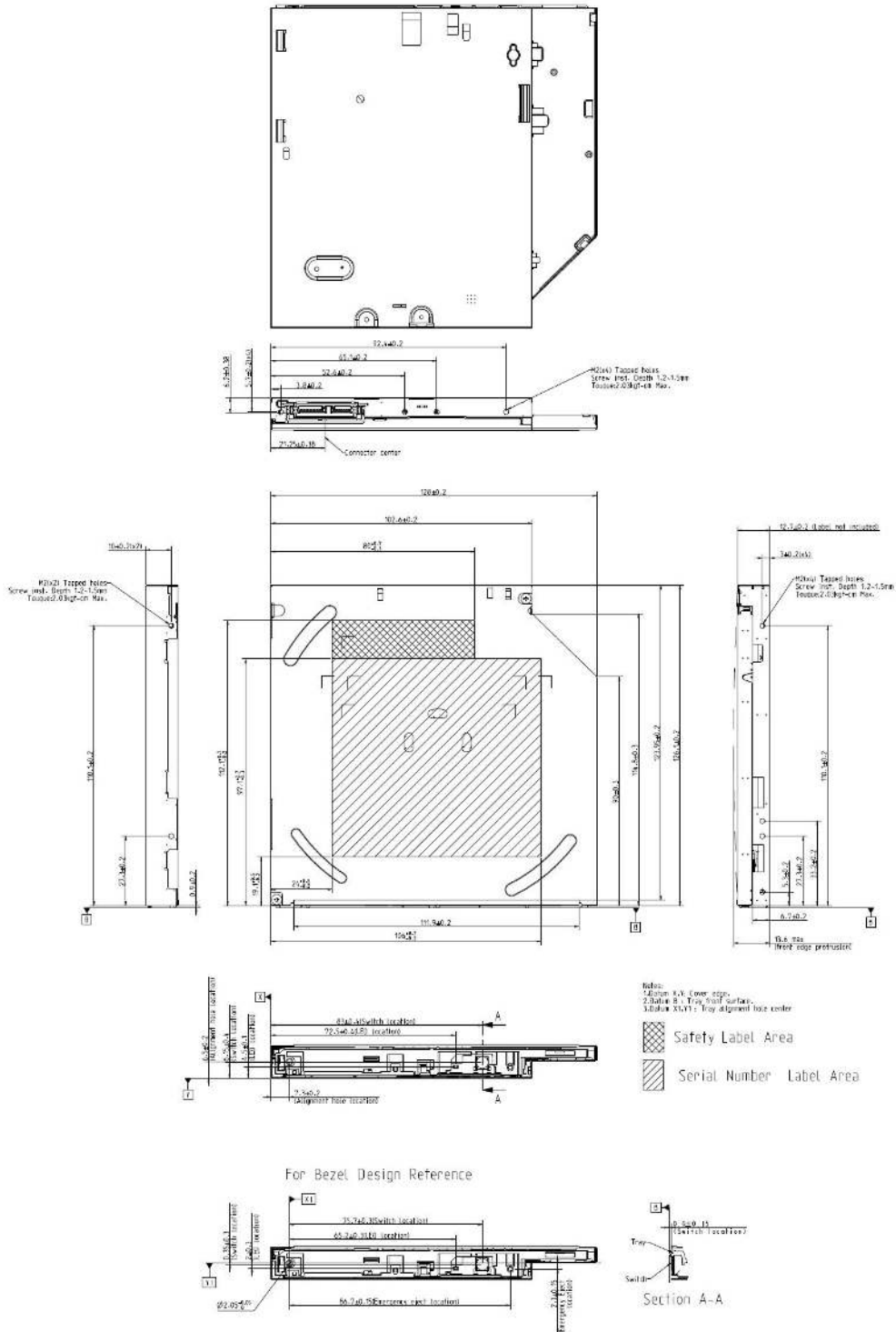

DOC NO	:		Rev.
Issued Date	:	2016/10/21	V2.0
Revised Date	:		

The Endurance Force on Top / Bottom Cover

