

Peak Emission Wavelength: 870nm

The 870nm IR emitter series is designed for applications requiring high output and precise optical / mechanical axis alignment. Custom package solutions and sorting are available.

FEATURES

- > Ceramic Dome Surface Mount 3.5×2.2×1.91
- > High Reliability
- > High Output Power
- > Narrow Beam Angle

APPLICATIONS

- > Optical Switches / Security Systems
- > Bar-code Reader
- > Fiber Optical Communications



Absolute Maximum Ratings (Ta=25°C)



ITEMS	SYMBOL	RATINGS	UNIT
Forward Current	IF	80	mA
Forward Current (Pulse)*1	IFP	0.5	A
Reverse Voltage	VR	5	V
Power Dissipation	PD	160	mW
Operating Temperature Range	Topr	-20 ~ +80	°C
Storage Temperature Range	Tstg	-30 ~ +100	°C
Junction Temperature	Tj	100	°C

*1: Tw=10µsec, T=10msec.

Electrical & Optical Characteristics (Ta = 25°C)

ITEMS	SYMBOL	CONDITIONS	MIN	TYP	MAX	UNIT
Power Output	PO	IF=50mA	--	4.6	--	mW
Forward Voltage	VF	IF=50mA	--	1.5	--	V
Reverse Current	IR	VR=5V	--	--	100	µA
Peak Emission Wavelength	λp	IF=50mA	--	870	--	nm
Spectral Line Half Width	Δλ	IF=50mA	--	45	--	nm
Half Intensity Beam Angle	Θ	IF=50mA	--	±10	--	deg

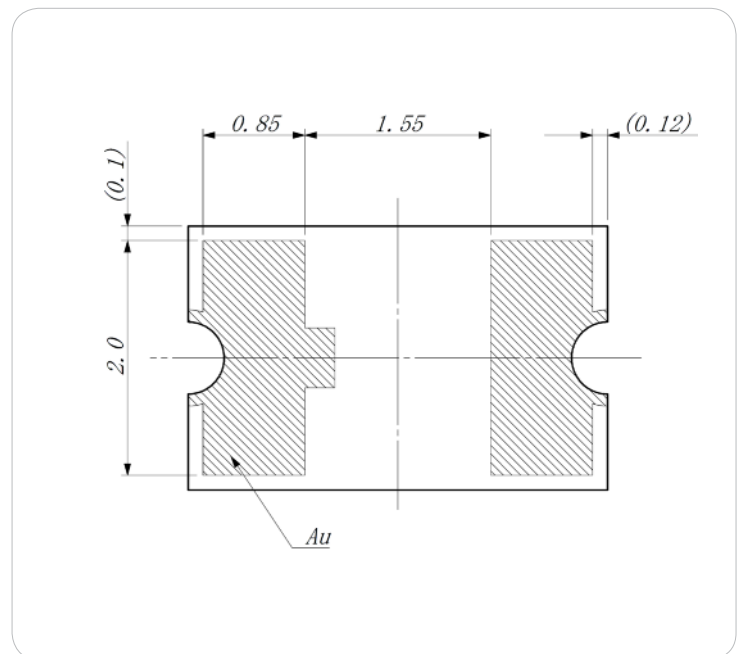
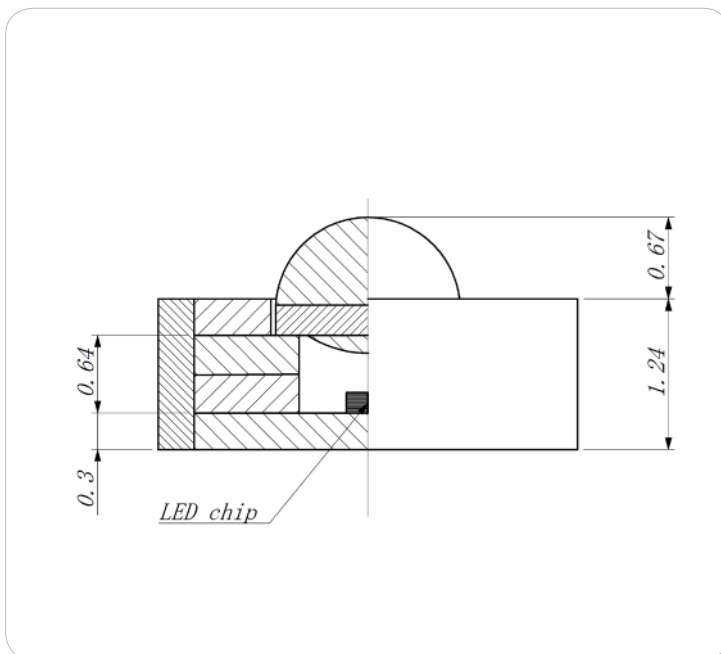
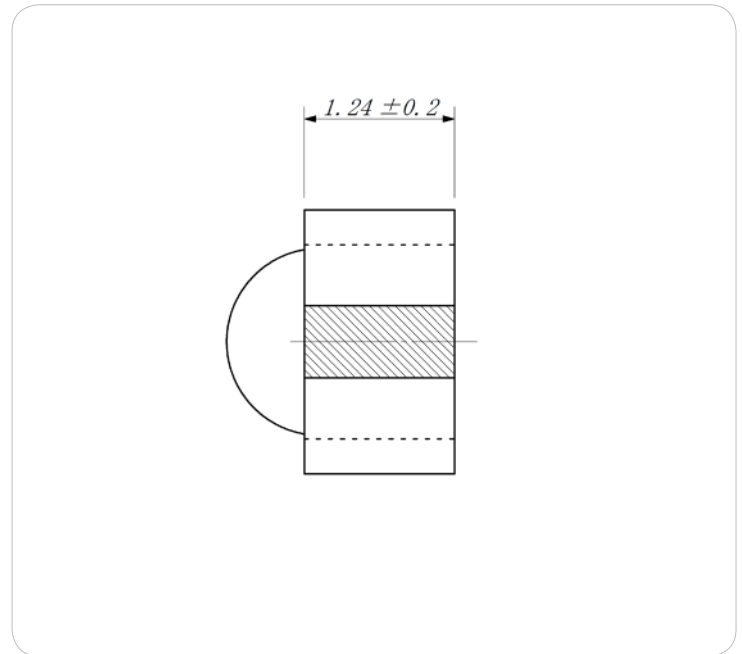
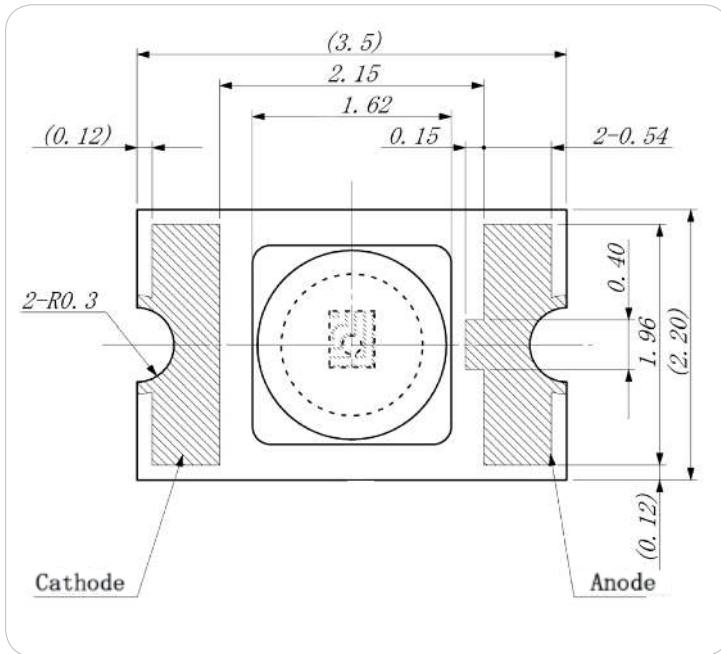

Unit: mm, Tolerance: ±0.2

