

Powerex, Inc., 173 Pavilion Lane, Youngwood, Pennsylvania 15697 (724) 925-7272
www.pwrx.com

Super Fast Recovery Diode Modules 140 Amperes/600 Volts

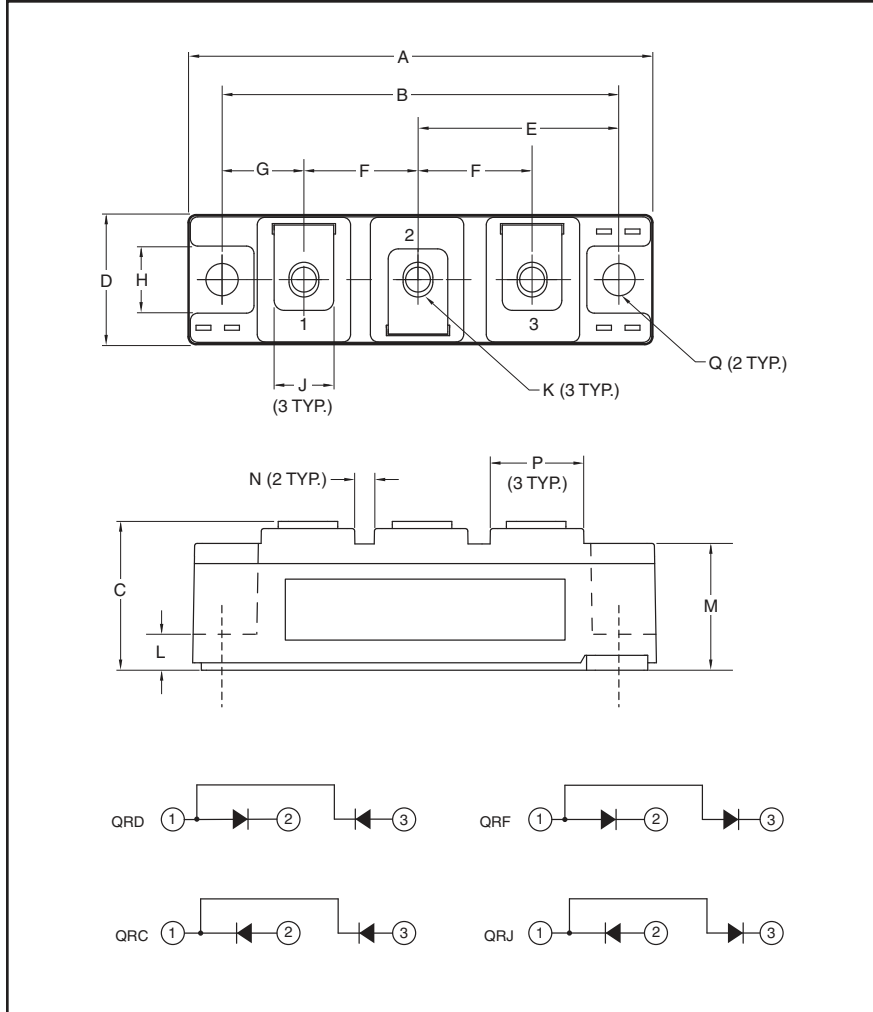

Description:

Powerex Super Fast Recovery Dual Diode Modules are designed for use in applications requiring fast switching. The modules are isolated for easy mounting with other components on common heatsinks.

Features:

- Super Fast Recovery Time
- RoHS Compliant
- Isolated Mounting
- Metal Baseplate
- Low Thermal Impedance
- 2500V Isolating Voltage

Applications:

- Free Wheeling
- Welding and Plasma Cutting Machine

Outline Drawing and Circuit Diagram

Dimensions	Millimeters
A	93.5
B	80
C	30
D	26
E	40.5
F	23
G	16.5
H	13

Dimensions	Millimeters
J	12
K	M5
L	7.5
M	25.4
N	4
P	19
Q	6.5 Dia.

QR_0620R30
Super Fast Recovery Dual Diode Modules
 140 Amperes/600 Volts

Absolute Maximum Ratings, $T_j = 25\text{ }^\circ\text{C}$ unless otherwise specified

Ratings	Symbol	QRD0620R30 QRC0620R30 QRF0620R30 QRJ0620R30	Units
Repetitive Peak Reverse Blocking Voltage	V_{RRM}	600	Volts
Non-Repetitive Peak Reverse Blocking Voltage	V_{RSM}	$V_{RRM} + 100$	Volts
DC Current, $T_C = 80^\circ\text{C}$ (Resistive load)	$I_{F(DC)}$	140	Amperes
Peak Half Cycle Non-repetitive Surge Current ($t = 8.3\text{mS}$, 100% V_{RRM} Reapplied)	I_{FSM}	TBD	Amperes
I^2t for Fusing for One Cycle ($t = 8.3\text{mS}$, 100% V_{RRM} Reapplied)	I^2t	TBD	A^2sec
Operating Junction Temperature	T_j	-40 to 150	$^\circ\text{C}$
Storage Temperature	T_{stg}	-40 to 125	$^\circ\text{C}$
Maximum Mounting Torque, M6 Mounting Screw	—	26	in-lb
Maximum Mounting Torque, M5 Terminal Screw	—	17	in-lb
Module Weight (Typical)	—	150	Grams
V Isolation (60 Hz, Circuit to Base, All Terminals Shorted, $t = 60\text{ sec}$)	V_{RMS}	2500	Volts

Electrical Characteristics, $T_j = 25\text{ }^\circ\text{C}$ unless otherwise specified

Characteristics	Symbol	Test Conditions	Min.	Typ.	Max.	Units
Reverse Leakage Current	I_{RRM}	Rated V_{RRM}	—	—	1.0	mA
On-State Voltage	V_{FM}	$I_F = 100\text{A}$	—	1.6	2.3	Volts
		$I_F = 140\text{A}$	—	1.8	2.5	Volts
Threshold Voltage	V_{TO}	$T_j = 125^\circ\text{C}$	—	1.82	—	Volts
Slope Resistance	r_T	$T_j = 125^\circ\text{C}$	—	4.14	—	$\text{m}\Omega$
Reverse Recovery Time	t_{rr}	$I_f = 100\text{A}$, $di/dt = \text{TBD}$	—	—	120	ns
Reverse Recovery Charge	Q_{rr}	$I_f = 100\text{A}$, $di/dt = \text{TBD}$	—	4.2	—	μC

Thermal and Mechanical Characteristics, $T_j = 25\text{ }^\circ\text{C}$ unless otherwise specified

Characteristics	Symbol	Test Conditions	Min.	Typ.	Max.	Units
Thermal Resistance, Junction to Case*	$R_{th(j-c)}$	Per Diode	—	—	0.205	$^\circ\text{C}/\text{W}$
Contact Thermal Resistance, Case to Sink (Lubricated)*	$R_{th(c-s)}$	Per Module	—	—	0.075	$^\circ\text{C}/\text{W}$

* T_C , T_f measured point is just under the chip.

QR_0620R30
Super Fast Recovery Dual Diode Modules
 140 Amperes/600 Volts

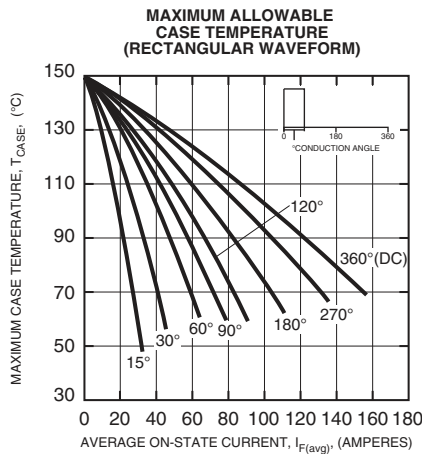
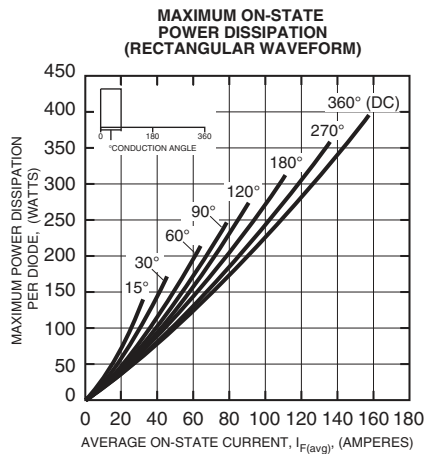
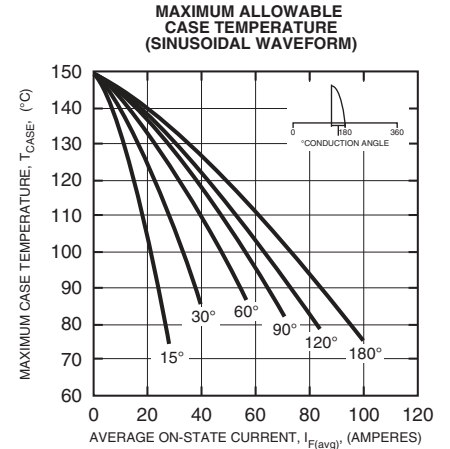
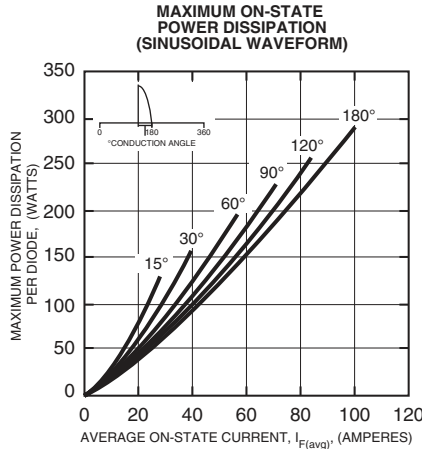
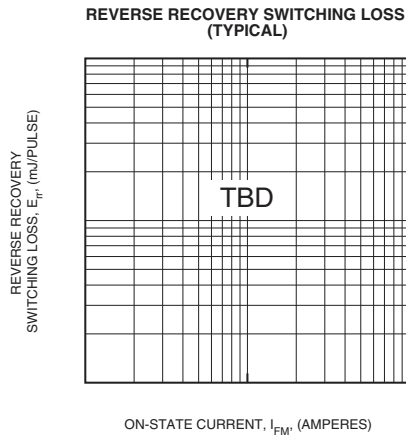
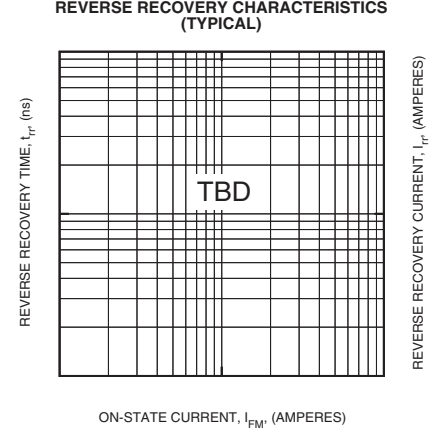
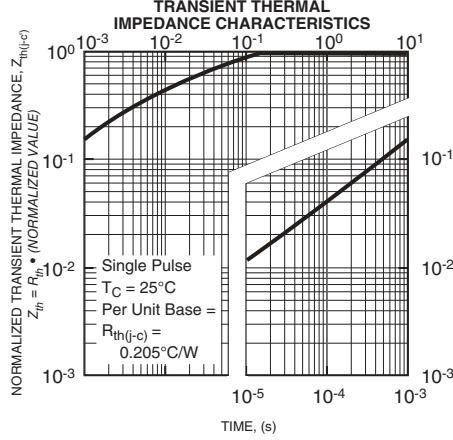
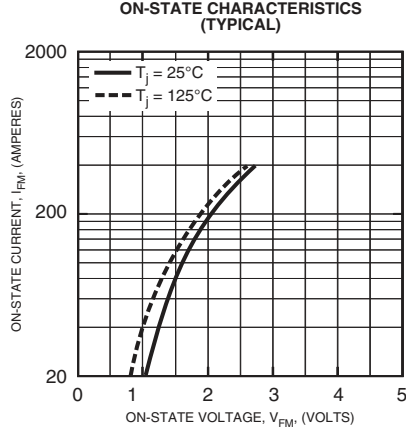

Information presented is based upon manufacturers testing and projected capabilities. This information is subject to change without notice. The manufacturer makes no claim as to the suitability of use, reliability, capability, or future availability of this product.