



MIC5282

120V_{IN}, 50mA, Ultra-Low I_Q, High-PSRR
Linear Regulator

General Description

The MIC5282 high-performance linear regulator offers a very-wide input operating voltage range, up to 120V DC, and supplies an output current of up to 50mA.

Ideal for high input voltage applications such as industrial and telecom, the MIC5282 offers $\pm 3\%$ initial accuracy, extremely high-power supply rejection ratio (80dB at 10kHz) and ultra-low quiescent current of 6 μ A. The MIC5282 is optimized for high-voltage line transients, making it ideal for harsh environment applications.

The MIC5282 is offered in both fixed output voltage (3.3V/5.0V) and adjustable output voltage (1.27V to 5.5V) options.

The MIC5282 operates over a -40°C to $+125^{\circ}\text{C}$ temperature range and is available in lead-free, RoHS-compliant, 8-pin ePad MSOP and 8-pin MSOP packages.

Data sheet and support documentation are found on the Micrel website: www.micrel.com.

Features

- Wide input voltage range: 6V to 120V DC
- Ultra-low quiescent current: 6 μ A
- 50mA guaranteed output current
- Adjustable output from 1.27V to 5.5V
- Withstands up to +120V DC at the input
- Stable with ceramic capacitors
- Ultra-high PSRR (80dB at 10kHz)
- Ultra-high line rejection (load dump)
- High output accuracy:
 - $\pm 3\%$ initial accuracy
- Thermal-shutdown and current-limit protection
- Thermally-efficient, 8-pin MSOP and 8-pin ePad MSOP packages

Applications

- Industrial
- Remote keyless entry power supply
- Telecom
- Off-line power supplies

Typical Applications

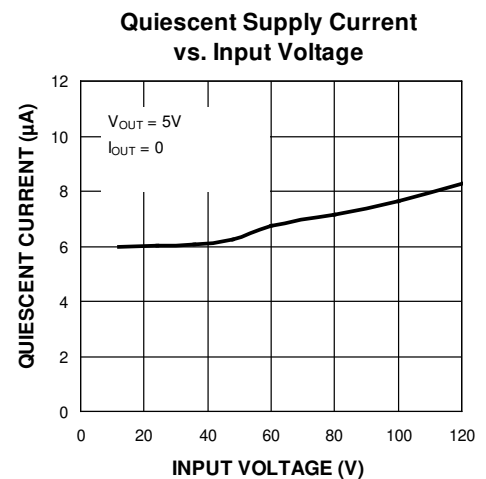
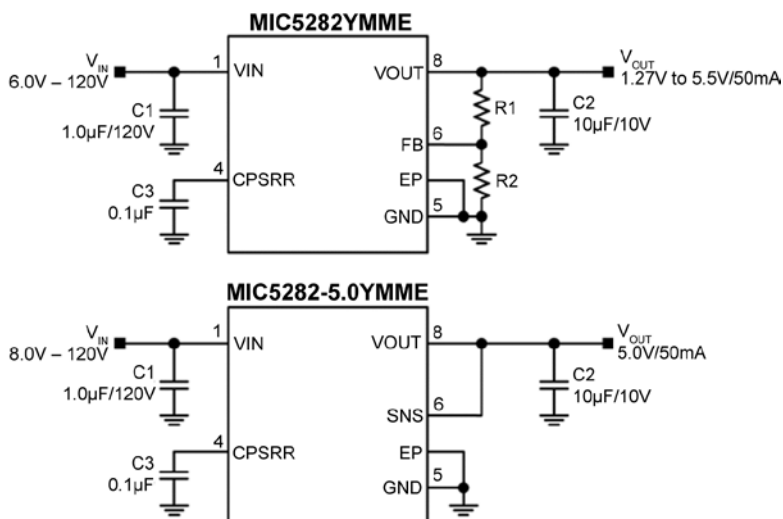

Ordering Information

Part Number	Output Voltage	Top Mark	Temperature Range	Package	Lead Finish
MIC5282YMME	Adjustable	A882	-40°C to +125°C	8-Pin ePad MSOP	Pb-Free
MIC5282-3.3YMME	3.3V	882S	-40°C to +125°C	8-Pin ePad MSOP	Pb-Free
MIC5282-5.0YMME	5.0V	5882	-40°C to +125°C	8-Pin ePad MSOP	Pb-Free
MIC5282YMM	Adjustable	-	-40°C to +125°C	8-Pin MSOP	Pb-Free
MIC5282-3.3YMM	3.3V	-	-40°C to +125°C	8-Pin MSOP	Pb-Free
MIC5282-5.0YMM	5.0V	-	-40°C to +125°C	8-Pin MSOP	Pb-Free

Pin Configuration

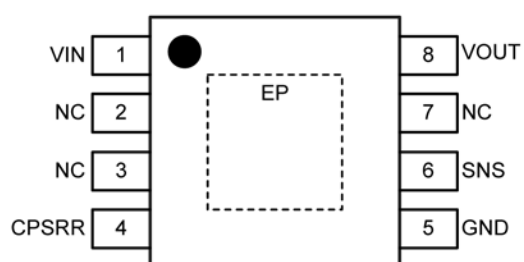

**8-Pin ePAD MSOP
MIC5282-x.xYMME**

(TOP VIEW)

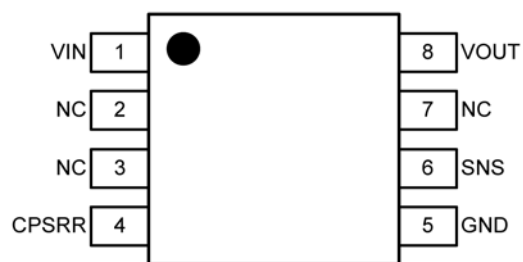

**8-Pin MSOP
MIC5282-x.xYMM**

(TOP VIEW)

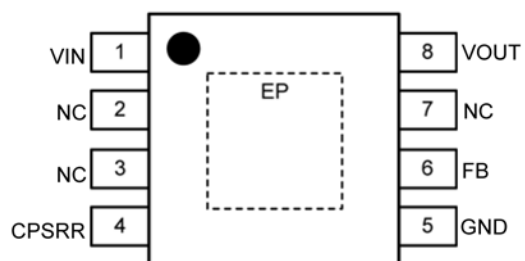

**8-Pin ePAD MSOP
MIC5282YMME**

(TOP VIEW)

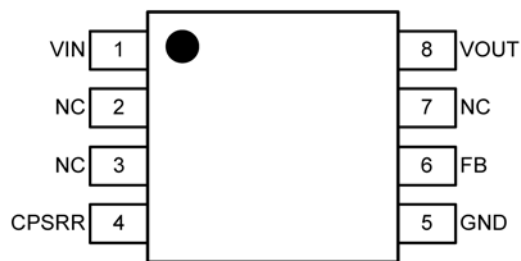

**8-Pin MSOP
MIC5282YMM**

(TOP VIEW)

Pin Description

Pin				Name	Function
MIC5282YMME	MIC5282-x.xYMME	MIC5282YMM	MIC5282-x.xYMM		
1	1	1	1	VIN	Supply Voltage Input. Connect 1 μ F capacitor from VIN to GND.
2, 3, 7	2, 3, 7	2, 3, 7	2, 3, 7	NC	Not internally connected. Connect NC to GND or leave unconnected.
4	4	4	4	CPSRR	Bypass Capacitor Connection. Connect 0.1 μ F capacitor from CPSRR to GND.
5	5	5	5	GND	Ground.
6	–	6	–	FB	Feedback Connection. For external resistor divider to set V _{OUT} .
–	6	–	6	SNS	Sense input. Connect SNS to V _{OUT} .
8	8	8	8	VOUT	Regulator Output. Connect 10 μ F capacitor from V _{OUT} to GND.
EP	EP	–	–	EP	Exposed Pad (ePad) for Thermal Relief. Connect EP to GND.

Absolute Maximum Ratings⁽¹⁾

V_{IN} to GND.....	-0.3V to +125V
V_{CPSRR} to GND.....	-0.3 to +14V
V_{FB} , V_{SNS} , V_{OUT} to GND	-0.3V to +6V
Lead Temperature (soldering, 10s).....	+260°C
Junction Temperature	-40°C ≤ T_J ≤ +125°C
Storage Temperature	-65°C ≤ T_A ≤ +150°C
ESD Ratings⁽⁴⁾	
HBM	2kV
MM.....	200V

Operating Ratings⁽²⁾

V_{IN}	+6V to +120V
V_{OUT} Adjust Range	+1.27V to +5.5V
Junction Temperature	-40°C ≤ T_J ≤ +125°C
Power Dissipation (P_D).....	Internally Limited ⁽³⁾
Junction Thermal Resistance (θ_{JA})	
8-pin ePad MSOP.....	64°C/W
8-pin MSOP	160°C/W

Electrical Characteristics⁽⁵⁾

$V_{IN} = 12V$, $C_{IN} = 1.0\mu F$, $C_{PSRR} = 0.1\mu F$, $C_{OUT} = 10\mu F$, $V_{OUT} = 5.0V$ or $3.3V$, $I_{OUT} = 100\mu A$, $T_A = 25^\circ C$, **bold** values indicate -40°C ≤ T_J ≤ +125°C, unless noted.

Parameter	Condition	Min.	Typ.	Max.	Units	
Power Supply Input						
Input Voltage Range ⁽⁶⁾		6		120	V	
Quiescent Supply Current ⁽⁷⁾	$I_{OUT} = 0$		6	11	μA	
Output Voltage						
Output Voltage	Adjustable	1.27		5.5	V	
	Fixed 3.3V	3.2	3.3	3.4		
		3.13	3.3	3.47		
	Fixed 5.0V	4.85	5.0	5.15		
4.75		5.0	5.25			
Output Voltage Accuracy	Variation from nominal V_{OUT}	-3		+3	%	
		-5		+5	%	
Load Regulation	$I_{OUT} = 100\mu A$ to 50mA	ePad	-1.0	0.5	+1.0	%
		non-ePad	-1.2	0.6	+1.2	
Line Regulation ⁽⁸⁾	$V_{IN} = 10V$ to 120V	-0.5	0.04	+0.5	%/V	
Feedback Input (Adjustable)						
FB Voltage		1.232	1.270	1.308	V	
		1.206	1.270	1.333		
FB Current	$V_{FB} = 1.27V$		3.2		nA	
Current Limit						
Current Limit	$V_{OUT} = 0V$	60	125	260	mA	
Ripple Rejection						
Power Supply Rejection Ratio ⁽⁹⁾	100Hz ≤ f ≤ 1kHz		65		dB	
	1kHz ≤ f ≤ 5kHz		75		dB	
	5kHz ≤ f ≤ 40kHz		80		dB	
	40kHz ≤ f ≤ 1MHz		90		dB	

Electrical Characteristics⁽⁵⁾ (Continued)

$V_{IN} = 12V$, $C_{IN} = 1.0\mu F$, $C_{PSRR} = 0.1\mu F$, $C_{OUT} = 10\mu F$, $V_{OUT} = 5.0V$ or $3.3V$, $I_{OUT} = 100\mu A$, $T_A = 25^\circ C$, **bold** values indicate $-40^\circ C \leq T_J \leq +125^\circ C$, unless noted.

Parameter	Condition	Min.	Typ.	Max.	Units
Power Dropout Voltage					
Dropout Voltage	$I_{OUT} = 50mA$		2	3	V
Thermal Protection					
Thermal-Shutdown Temperature	T_J rising		157		$^\circ C$
Thermal-Shutdown Hysteresis			15		$^\circ C$

Notes:

1. Exceeding an absolute maximum rating may damage the device.
2. The device is not guaranteed to function outside its operating rating.
3. The maximum allowable power dissipation at any T_A (ambient temperature) is $P_{D(max)} = (T_{J(max)} - T_A) / \theta_{JA}$. Exceeding the maximum allowable power dissipation results in excessive die temperature, and causes the regulator to enter thermal shutdown.
4. Devices are ESD sensitive; use proper handling precautions.
5. Specifications are for packaged products only.
6. Assure that $V_{IN} \geq (V_{OUT} + 3V)$ and $V_{IN} \geq 6V$.
7. Quiescent current is specified for the adjustable option. The fixed options will add approximately $1\mu A$ due to the internal feedback resistors.
8. Line regulation is a percentage of V_{OUT} .
9. See Typical Characteristics Curve on Pg. 8

Typical Characteristics

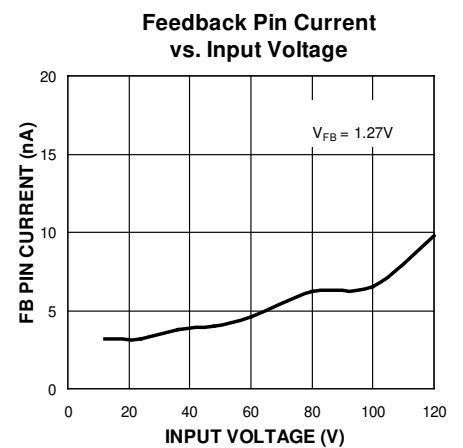
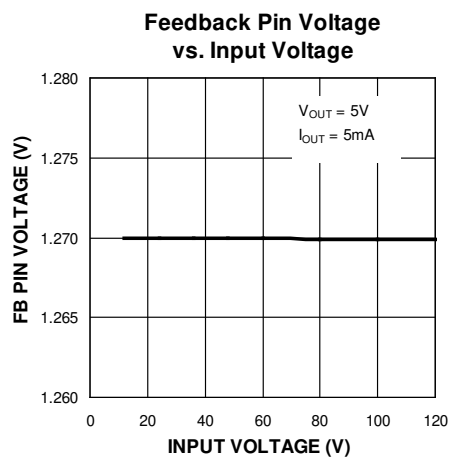
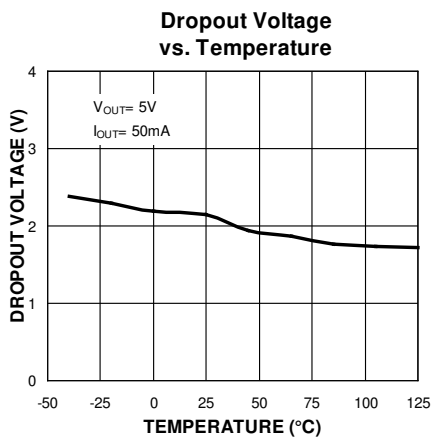
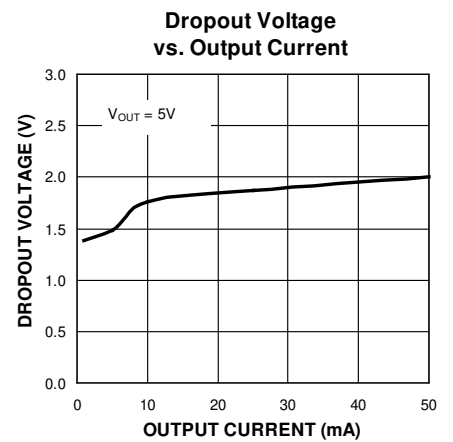
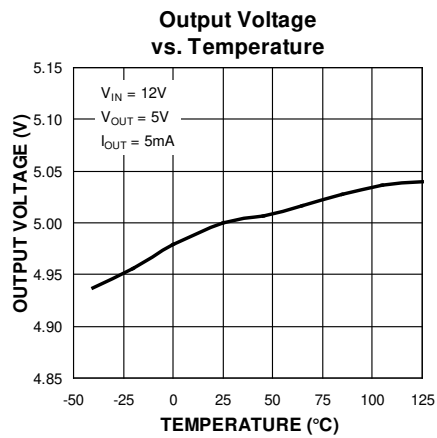
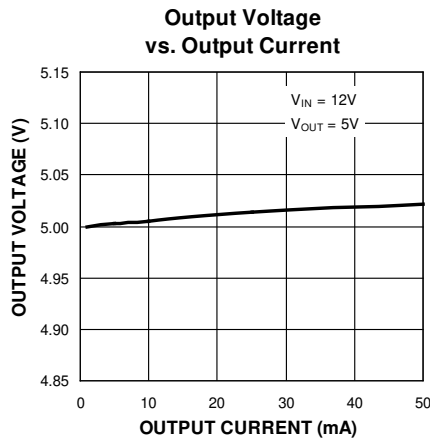
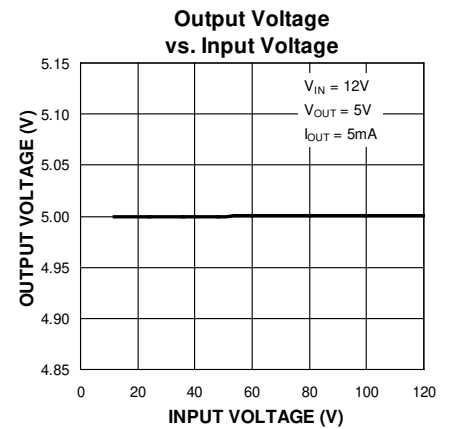
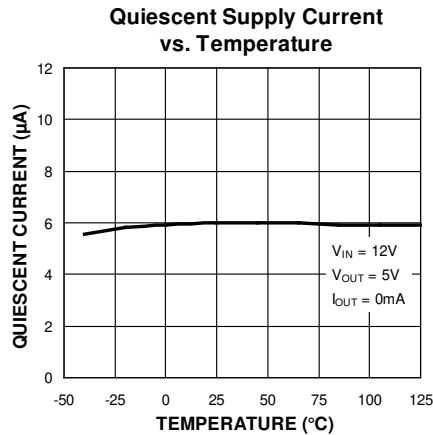
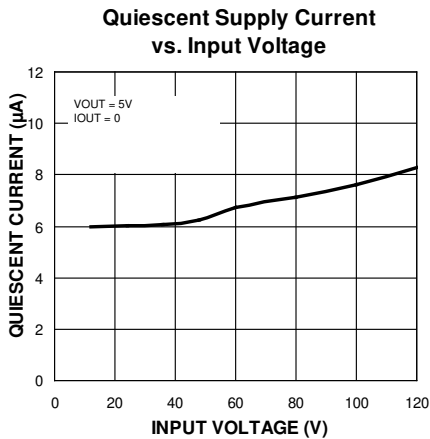

Typical Characteristics (Continued)

Feedback Pin Voltage vs. Temperature

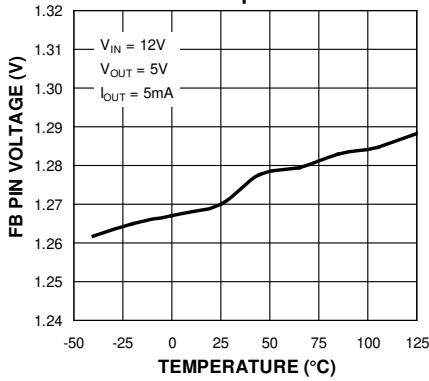

Feedback Pin Current vs. Temperature

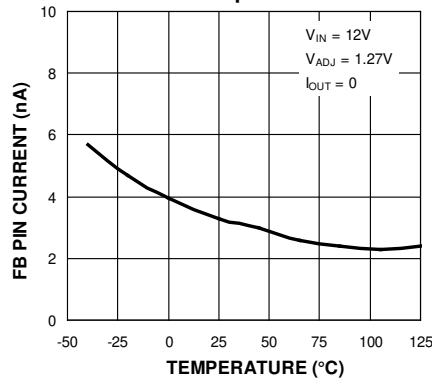

Feedback Pin Voltage vs. Output Current

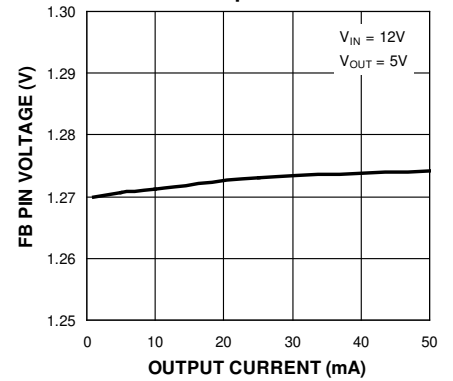

Current Limit vs. Temperature

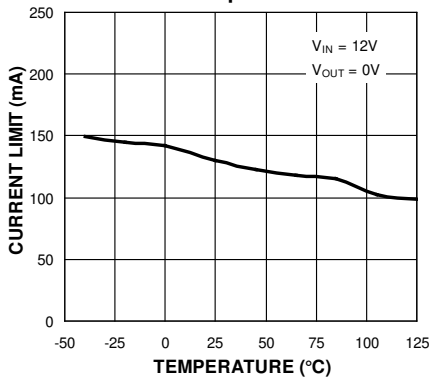

Line Regulation vs. Temperature

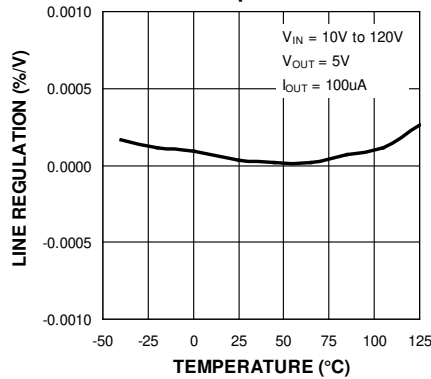

Load Regulation vs. Temperature

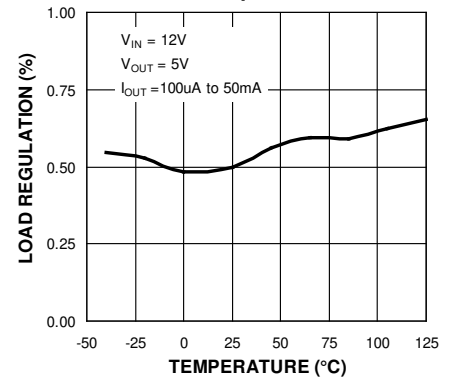

Power Dissipation vs. Output Current

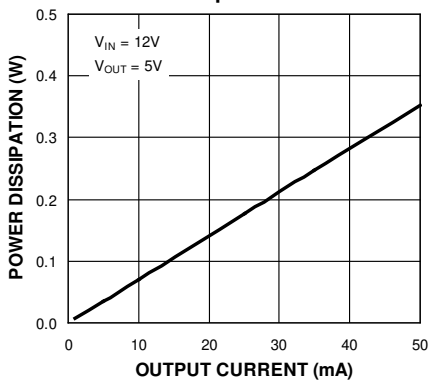

Case Temperature* (MME) vs. Output Current

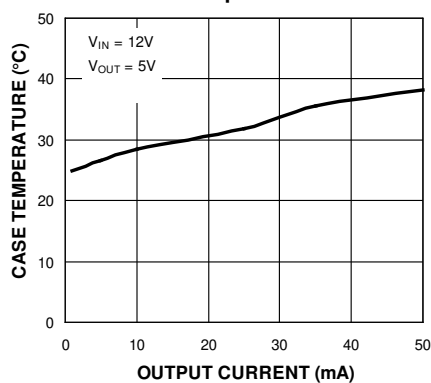

PSRR vs. Frequency

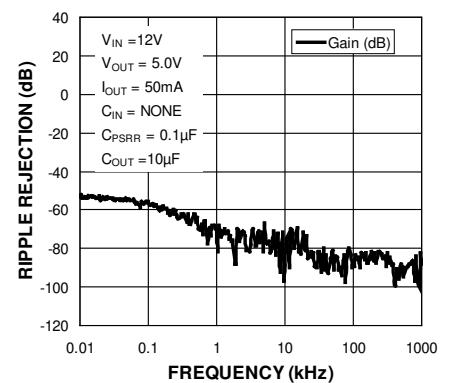

Case Temperature*: The temperature measurement was taken at the hottest point on the MIC5282 case mounted on a 2.25 square inch PCB at an ambient temperature of 25°C; see “Thermal Measurement” section. Actual results will depend upon the size of the PCB, ambient temperature and proximity to other heat emitting components.

Functional Characteristics

Soft Turn-On into Full Load

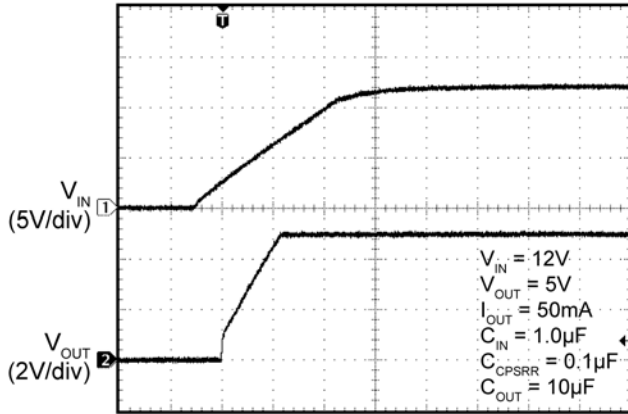

Time (4.00ms/div)

Soft Turn-Off

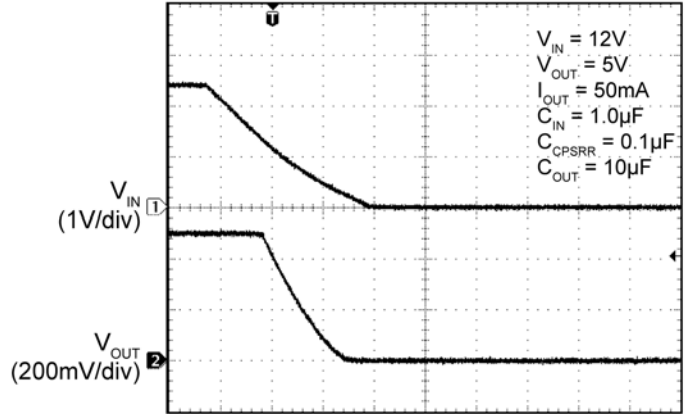

Time (20ms/div)

Hot Plug

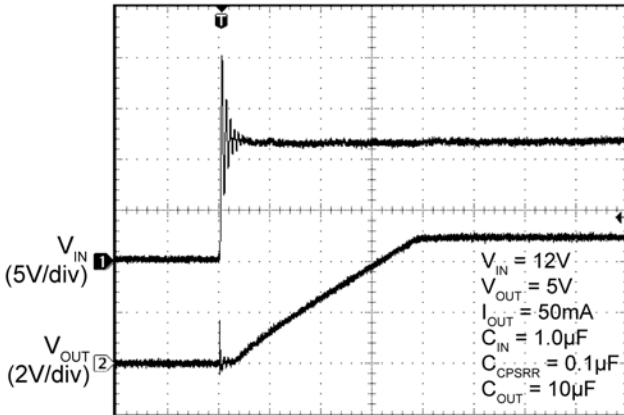

Time (100µs/div)

Hot Un-Plug

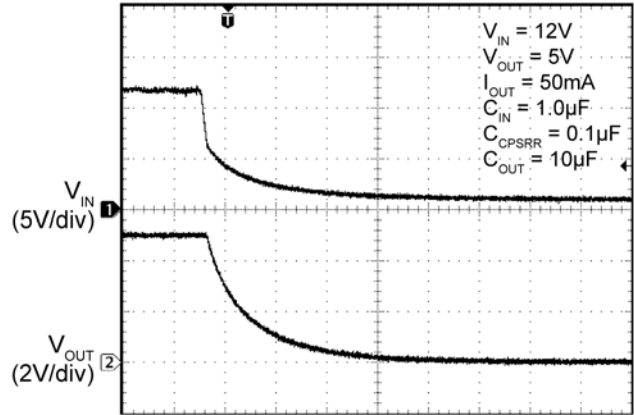

Time (1.00ms/div)

V_{IN} UVLO Threshold

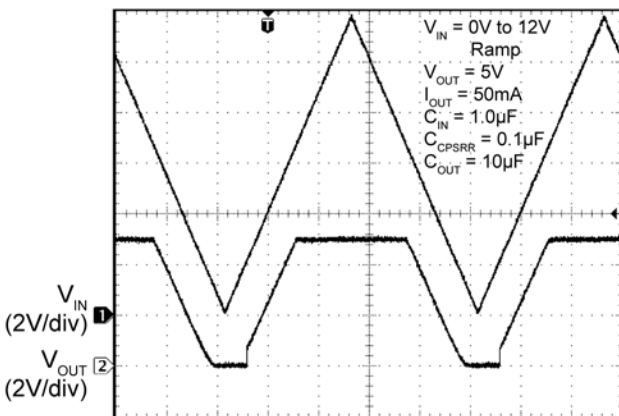

Time (200ms/div)

Current Limit

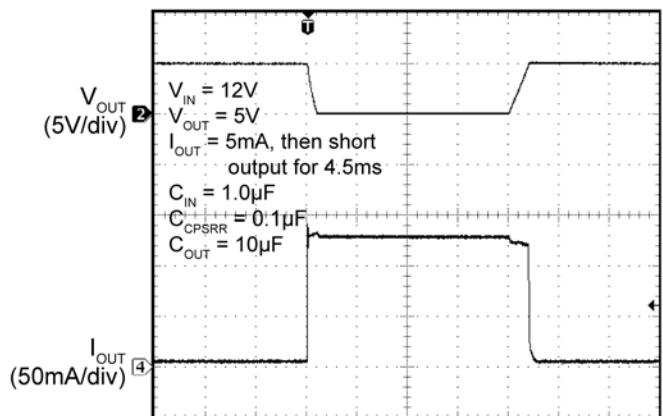

Time (1.00ms/div)

Functional Characteristics (Continued)

Thermal-Shutdown Response

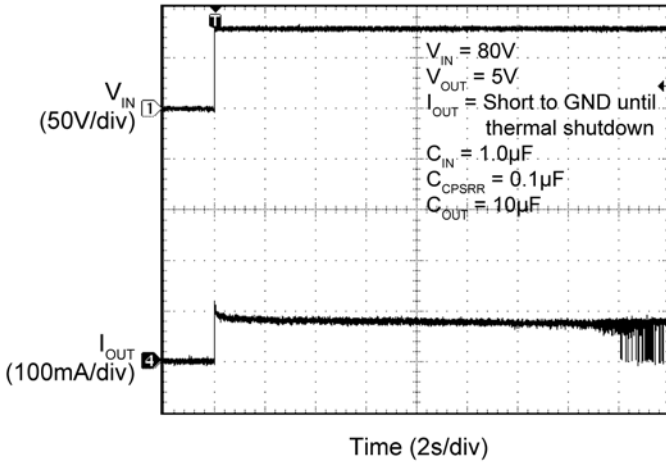

V_{OUT} Recovery from Thermal Shutdown

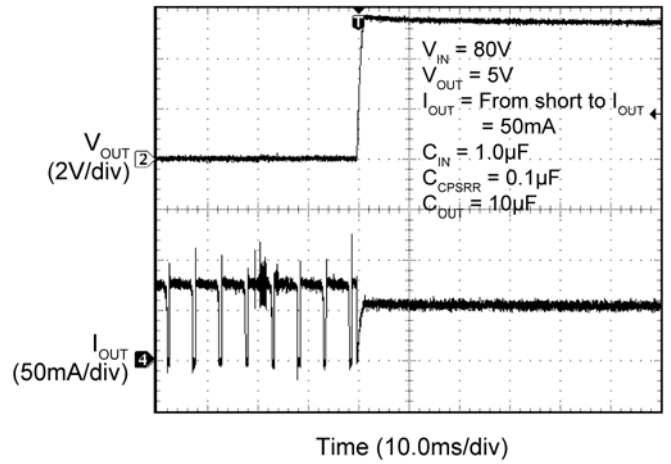

Turn-On into Short Circuit

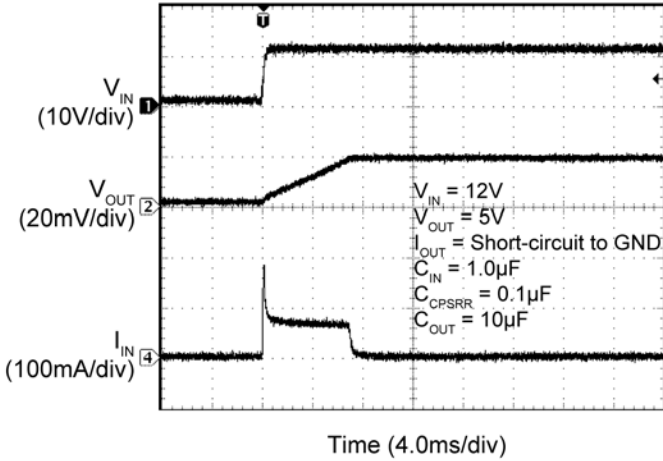

Inrush Current Response

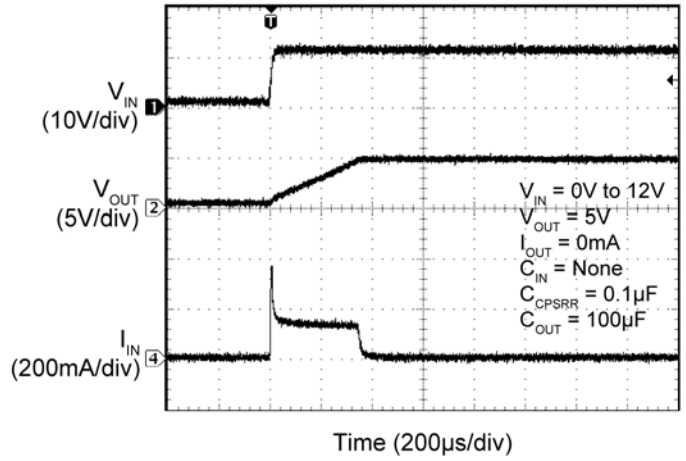

Load Transient Response

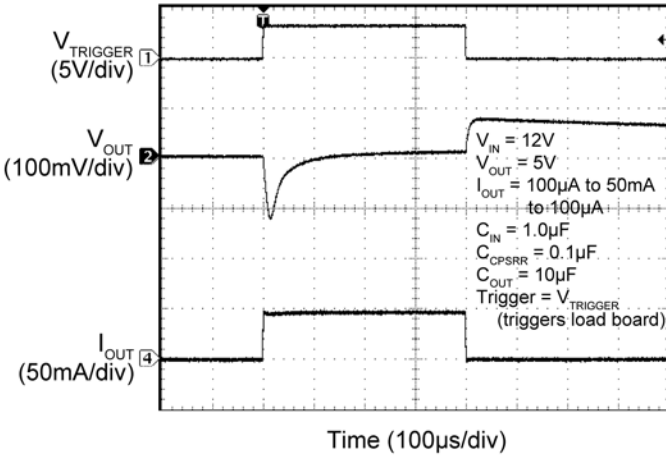

Line Transient Response

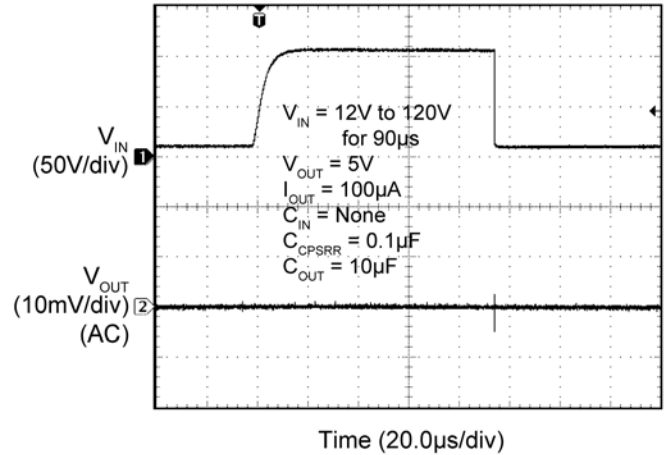

Detailed Description

The MIC5282 voltage regulator accepts a 6V to 120V input and has an ultra-low 6 μ A typical quiescent current while offering an excellent line transient response and PSRR. These features make it ideal for harsh, noisy environments. All options of the device offer 50mA of output current. The MIC5282YMM and MIC5282YMME offer an adjustable output voltage from 1.27V to 5.5V. The MIC5282-3.3YMME and MIC5282-3.3YMM offer fixed 3.3V outputs and the MIC5282-5.0YMME and MIC5282-5.0YMM offer fixed 5.0V outputs. The YMME packaged devices feature a heat slug to more effectively remove heat from the die.

Applications Information

Thermal Protection

MIC5282 has internal thermal shutdown to protect it from excessive heating of the die. When the junction temperature exceeds approximately +155°C, the output is disabled and the device begins to cool down. The device turns back on when the junction temperature cools by 15°C. This will result in a cycled output during continuous thermal-overload conditions.

Current Limit

MIC5282 features output current-limit protection. The output sustains a continuous short circuit to GND without damage to the device, but thermal shutdown often results.

Input Capacitor

Connect a 1.0 μ F capacitor from VIN to GND. Micrel recommends the C5750X7R2E105M, 1.0 μ F, 250V capacitor made by TDK. When using a different capacitor, assure that the voltage rating of the capacitor exceeds any potential transient.

CPSRR Capacitor

Connect a 0.1 μ F capacitor from CPSRR to GND to maintain high power supply rejection. The voltage rating of the capacitor must be at least 14V.

Output Capacitor

Connect a 10 μ F capacitor from VOUT to GND. Assure that the voltage rating of the capacitor exceeds the designed output voltage of the MIC5282.

Output Voltage Setting

For the MIC5282YMME and MIC5282YMM, V_{OUT} is programmed from 1.27V to 5.5V using:

$$V_{OUT} = V_{REF} \times \left(\frac{R1}{R2} + 1 \right)$$

where $V_{REF} = 1.27V$, and R1 and R2 are shown in the Typical Applications circuit.

Thermal Measurements

It is always wise to measure an IC's case temperature to make sure that it is within operating limits, but it is easy to get erroneous results. The standard thermal couple that comes with many voltage meters uses a large wire gauge that behaves like a heat-sink, resulting in artificially low case temperature measurements. Use a thermocouple of 36-gauge wire or smaller, such as the Omega (5SC-TT-K-36-36), to minimize the heat-sinking effect. Also, apply thermal compound to maximize heat transfer between the IC and the thermocouple.

An infrared thermometer is a recommended alternative. The IR thermometer from Optris has a 1mm spot size, ideal for monitoring small surface mount packages. Also, the optional stand makes it easy to keep the beam on the IC for long periods of time.

Functional Diagram

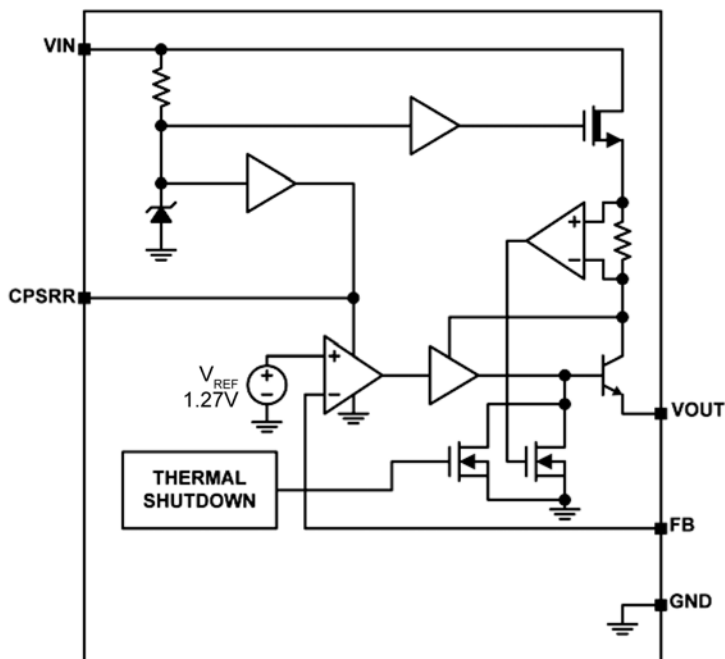

MIC5282 Adjustable Version

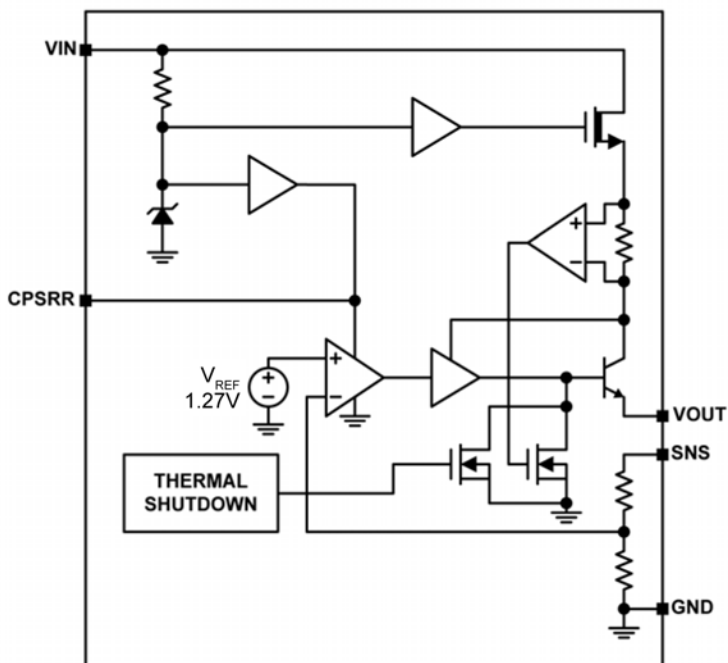

MIC5282 Fixed Version

MIC5282 Evaluation Board Schematic

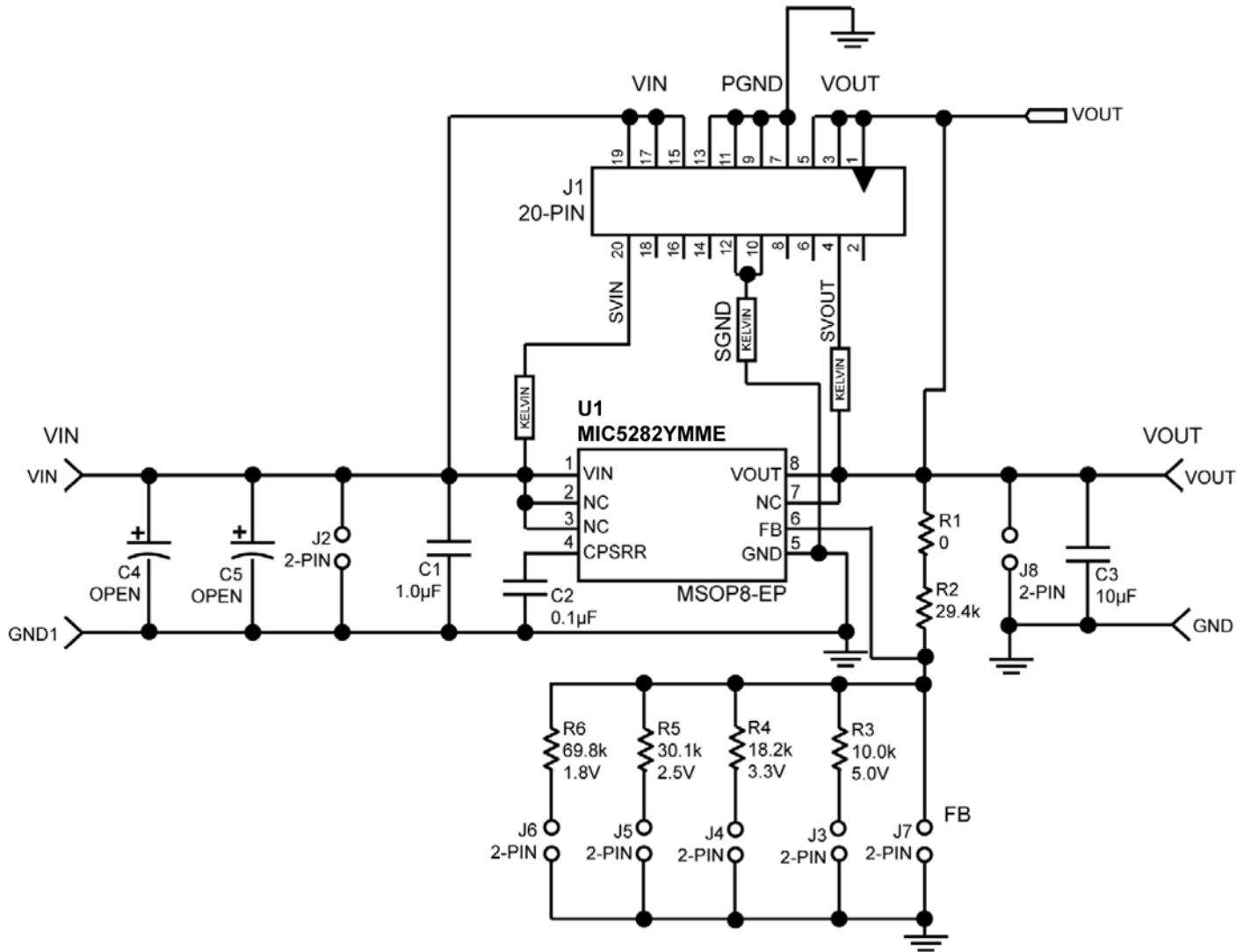

MIC5282 Evaluation Board Schematic

Bill of Materials

Item	Part Number	Manufacturer	Description	Qty.
C1	C5750X7R2E105M	TDK ⁽¹⁾	1.0 μ F, 250V, 20%, X7R capacitor (2220)	1
C2	08053C104KAT2A	AVX ⁽²⁾	0.1 μ F 25V 20%, X7R capacitor (0805)	1
C3	0805ZD106KAT2A	AVX	10 μ F, 10V, 20%, X5R, capacitor (0805)	1
C4	OPEN	Panasonic ⁽³⁾	100 μ F, 160V, 20% capacitor (ALU, 0.492" diameter can 0.197" lead spacing - Part # ECA-2CM101)	0
C5	OPEN	ANY	Capacitor	0
R1	CRCW06030000F	Vishay/Dale ⁽⁴⁾	0 Ω , 1% resistor, 0603	1
R2	CRCW06032942F	Vishay/Dale	29.4k Ω , 1% resistor, 0603	1
R3	CRCW06031002F	Vishay/Dale	10.0k Ω , 1% resistor, 0603	1
R4	CRCW06031822F	Vishay/Dale	18.2k Ω , 1%, resistor, 0603	1
R5	CRCW06033012F	Vishay/Dale	30.1k Ω , 1% resistor chip, 0603	1
R6	CRCW06036982F	Vishay/Dale	69.8k Ω , 1%, resistor, 0603	1
U1	MIC5282YMME	Micrel⁽⁵⁾	120V_{IN}, 50mA, Ultra-Low I_Q, High-PSRR Linear Regulator	1

Notes:

1. TDK: www.tdk.com.
2. AVX: www.avx.com.
3. Panasonic: www.panasonic.com.
4. Vishay Tel: www.vishay.com.
5. **Micrel, Inc.:** www.micrel.com.

PCB Evaluation Board Layout

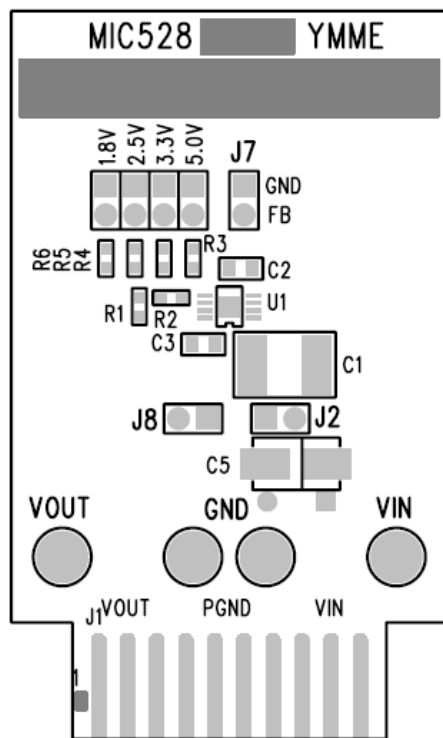

Top Layer Silk Screen

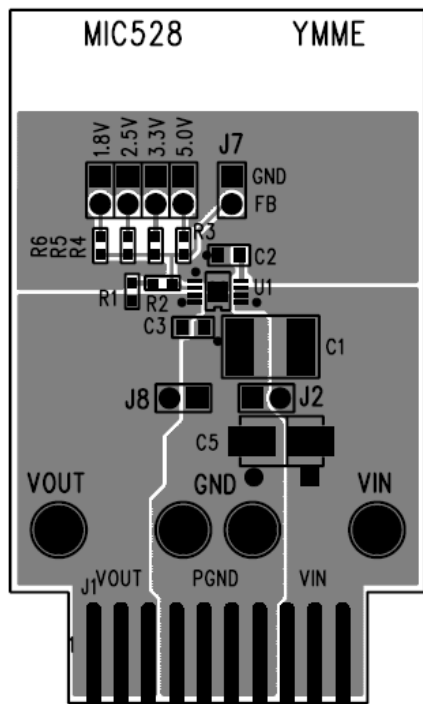

Top Layer Traces

PCB Evaluation Board Layout (Continued)

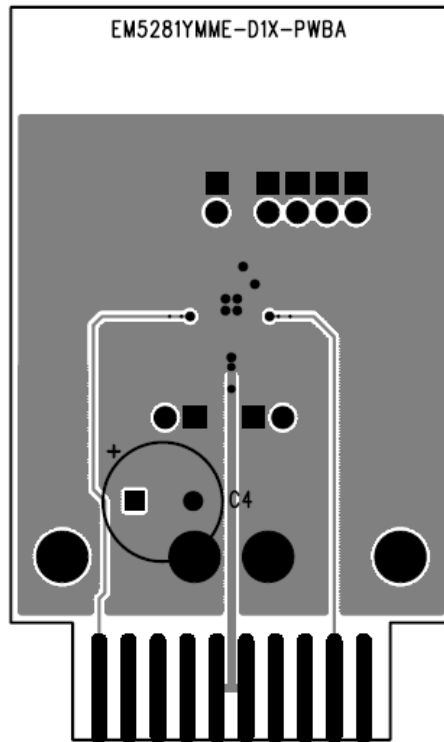

Bottom Layer Traces

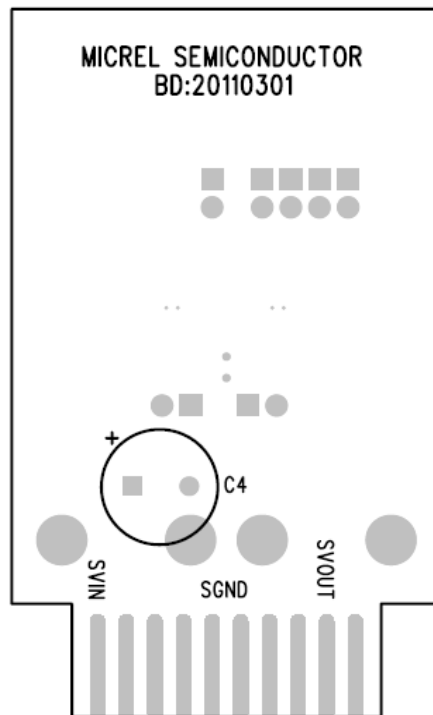

Bottom Layer Silk Screen

PCB Evaluation Board Layout (Continued)

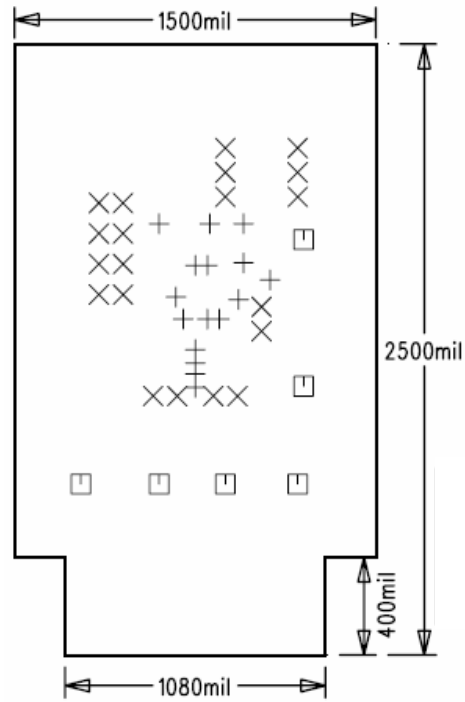

EV Board Dimensions

Package Information and Recommended Landing Pattern⁽¹⁾

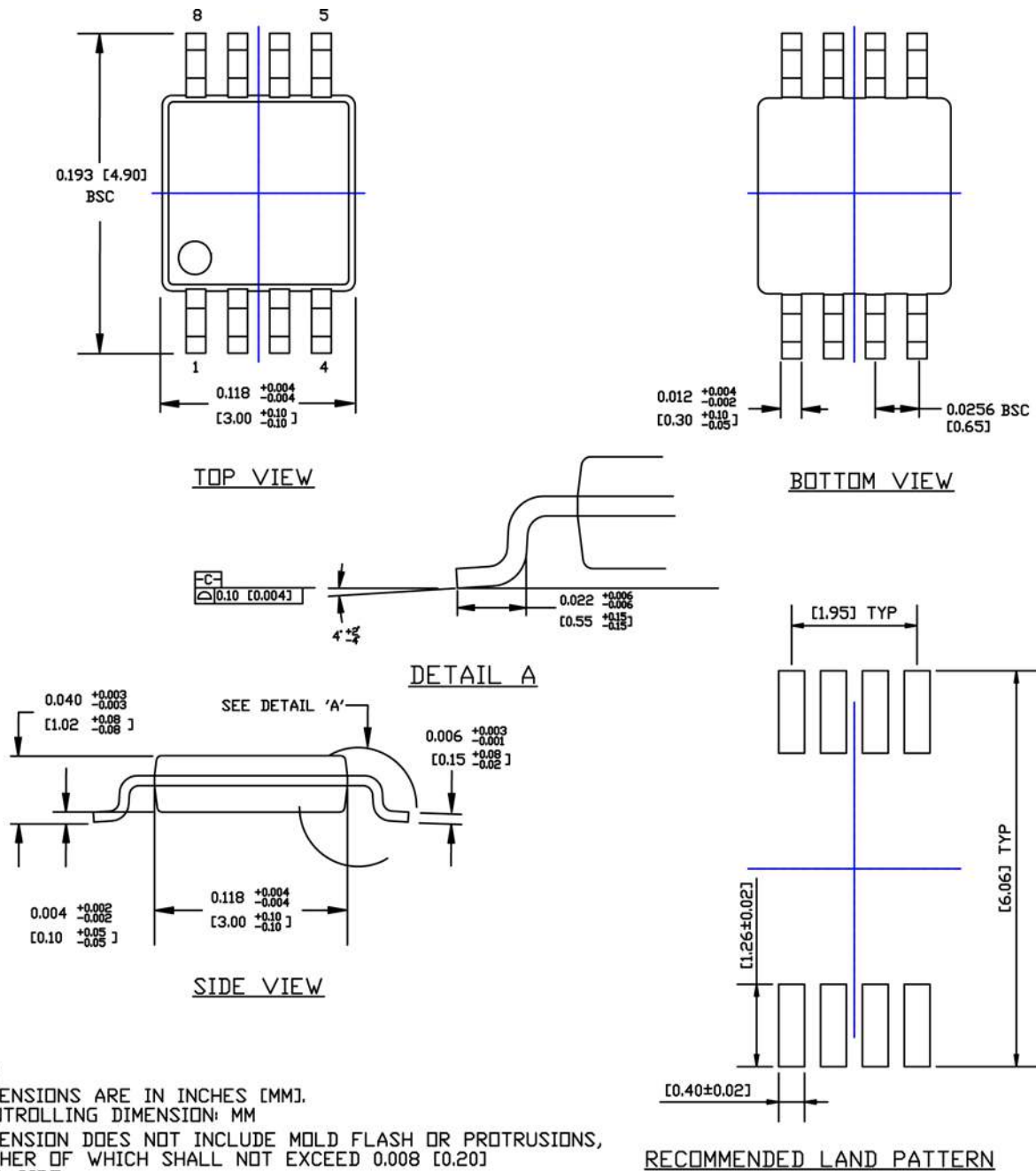

8-Pin MSOP

Note:

1. Package information is correct as of the publication date. For updates and most current information, go to www.micrel.com.

Package Information and Recommended Landing Pattern⁽¹⁾ (Continued)

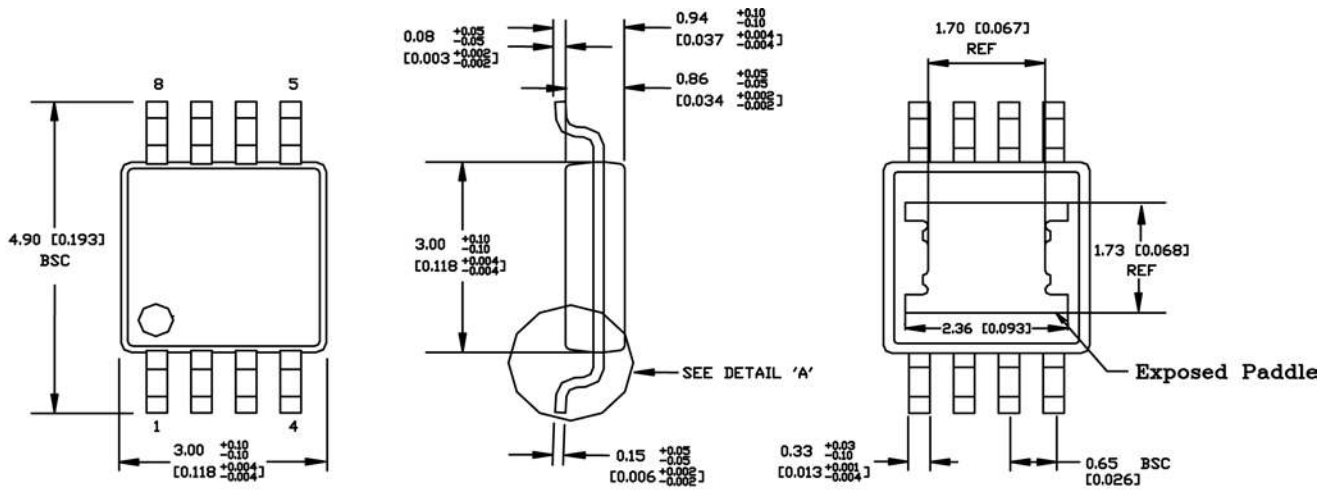

TOP VIEW

END VIEW

BOTTOM VIEW

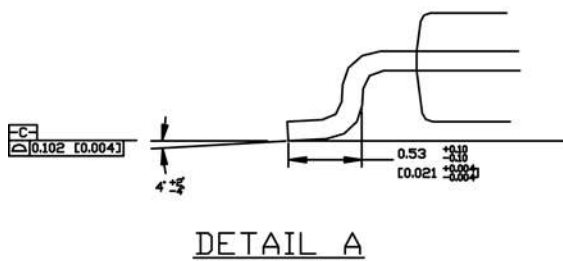

DETAIL A

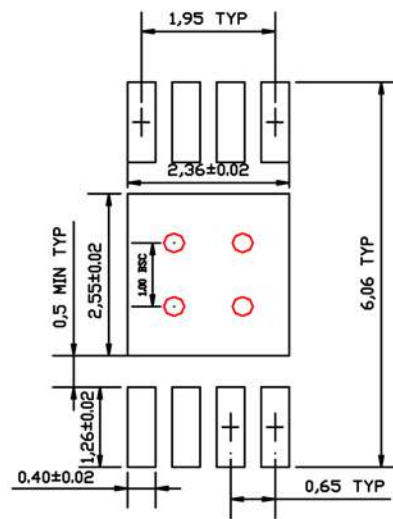

RECOMMENDED LAND PATTERN

NOTE:

1. DIMENSION DOES NOT INCLUDE MOLD FLASH OR PROTRUSIONS, EITHER OF WHICH SHALL NOT EXCEED 0.20 [0.008] PER SIDE
2. RED CIRCLES IN LAND PATTERN REPRESENT THERMAL VIAS. RECOMMENDED SIZE IS 0.30-0.35MM IN DIAMETER, 1.00 PITCH AND SHOULD BE CONNECTED TO GND FOR MAXIMUM PERFORMANCE

8-Pin Exposed Pad (ePad) MSOP

MICREL, INC. 2180 FORTUNE DRIVE SAN JOSE, CA 95131 USA
TEL +1 (408) 944-0800 FAX +1 (408) 474-1000 WEB <http://www.micrel.com>

Micrel makes no representations or warranties with respect to the accuracy or completeness of the information furnished in this data sheet. This information is not intended as a warranty and Micrel does not assume responsibility for its use. Micrel reserves the right to change circuitry, specifications and descriptions at any time without notice. No license, whether express, implied, arising by estoppel or otherwise, to any intellectual property rights is granted by this document. Except as provided in Micrel's terms and conditions of sale for such products, Micrel assumes no liability whatsoever, and Micrel disclaims any express or implied warranty relating to the sale and/or use of Micrel products including liability or warranties relating to fitness for a particular purpose, merchantability, or infringement of any patent, copyright or other intellectual property right.

Micrel Products are not designed or authorized for use as components in life support appliances, devices or systems where malfunction of a product can reasonably be expected to result in personal injury. Life support devices or systems are devices or systems that (a) are intended for surgical implant into the body or (b) support or sustain life, and whose failure to perform can be reasonably expected to result in a significant injury to the user. A Purchaser's use or sale of Micrel Products for use in life support appliances, devices or systems is a Purchaser's own risk and Purchaser agrees to fully indemnify Micrel for any damages resulting from such use or sale.

© 2011 Micrel, Incorporated.