

## ACSC08-51ZGKWA Surface Mount Display

### DESCRIPTIONS

- The Green source color devices are made with InGaN on Sapphire Light Emitting Diode
- Electrostatic discharge and power surge could damage the LEDs
- It is recommended to use a wrist band or anti-electrostatic glove when handling the LEDs
- All devices, equipments and machineries must be electrically grounded

### FEATURES

- 0.8 inch digit height
- Low current operation
- Excellent character appearance
- Mechanically rugged
- Gray face, white segment
- Package: 200 pcs / reel
- Moisture sensitivity level: 2a
- RoHS compliant

### APPLICATIONS

- Home and smart appliances
- Display time and digital combination
- Industrial and instrumental applications
- Numeric status

### ATTENTION

Observe precautions for handling electrostatic discharge sensitive devices



### PACKAGE DIMENSIONS

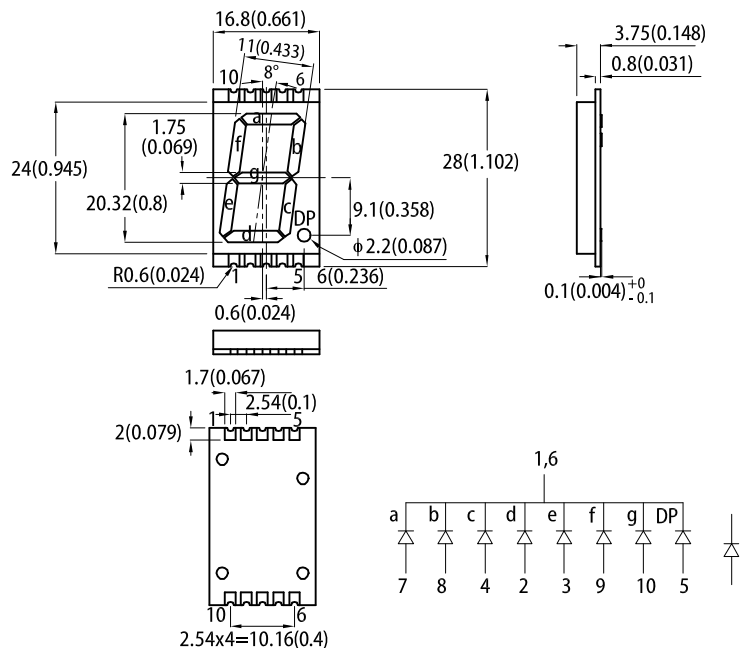

### RECOMMENDED SOLDERING PATTERN

(units: mm; tolerance:  $\pm 0.15$ )

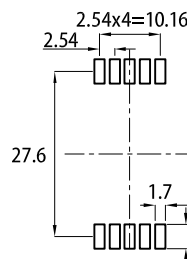

#### Notes:

1. All dimensions are in millimeters (inches). Tolerance is  $\pm 0.25 (0.01")$  unless otherwise noted.
2. The specifications, characteristics and technical data described in the datasheet are subject to change without prior notice.
3. The gap between the reflector and PCB shall not exceed 0.25mm.

### SELECTION GUIDE

Part Number	Emitting Color (Material)	Lens Type	Iv (ucd) @ 10mA <sup>[1]</sup>		Description
			Min.	Typ.	
ACSC08-51ZGKWA	■ Green (InGaN)	White Diffused	52000	118000	Common Cathode, Rt. Hand Decimal
			*21000	*40000	

#### Notes:

1. Luminous intensity / luminous Flux:  $\pm 15\%$ .
- \* Luminous intensity value is traceable to CIE127-2007 standards.

**ELECTRICAL / OPTICAL CHARACTERISTICS at T<sub>A</sub>=25°C**

Parameter	Symbol	Emitting Color	Value		Unit
			Typ.	Max.	
Wavelength at Peak Emission I <sub>F</sub> = 10mA	λ <sub>peak</sub>	Green	515	-	nm
Dominant Wavelength I <sub>F</sub> = 10mA	λ <sub>dom</sub> <sup>[1]</sup>	Green	525	-	nm
Spectral Bandwidth at 50% Φ REL MAX I <sub>F</sub> = 10mA	Δλ	Green	35	-	nm
Capacitance	C	Green	45	-	pF
Forward Voltage I <sub>F</sub> = 10mA	V <sub>F</sub> <sup>[2]</sup>	Green	3.0	3.4	V
Reverse Current (V <sub>R</sub> = 5V)	I <sub>R</sub>	Green	-	50	uA

## Notes:

1. The dominant wavelength (λ<sub>d</sub>) above is the setup value of the sorting machine. (Tolerance λ<sub>d</sub> : ±1nm.)
2. Forward voltage: ±0.1V.
3. Wavelength value is traceable to CIE127-2007 standards.
4. Excess driving current and / or operating temperature higher than recommended conditions may result in severe light degradation or premature failure.

**ABSOLUTE MAXIMUM RATINGS at T<sub>A</sub>=25°C**

Parameter	Symbol	Value	Unit
Power Dissipation	P <sub>D</sub>	102.5	mW
Reverse Voltage	V <sub>R</sub>	5	V
Junction Temperature	T <sub>j</sub>	115	°C
Operating Temperature	T <sub>op</sub>	-40 to +85	°C
Storage Temperature	T <sub>stg</sub>	-40 to +85	°C
DC Forward Current	I <sub>F</sub>	25	mA
Peak Forward Current	I <sub>FM</sub> <sup>[1]</sup>	150	mA
Electrostatic Discharge Threshold (HBM)	-	450	V

## Notes:

1. 1/10 Duty Cycle, 0.1ms Pulse Width.
2. Relative humidity levels maintained between 40% and 60% in production area are recommended to avoid the build-up of static electricity – Ref JEDEC/JESD625-A and JEDEC/J-STD-033.

## TECHNICAL DATA

### RELATIVE INTENSITY vs. WAVELENGTH

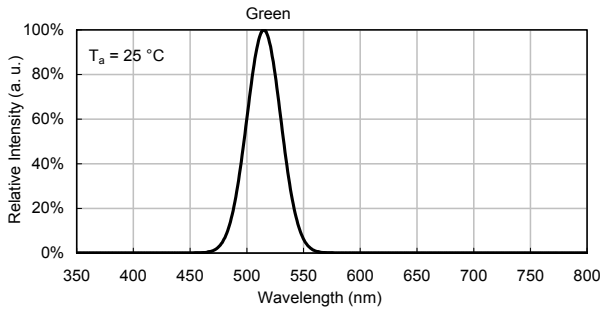

## GREEN

Forward Current vs. Forward Voltage

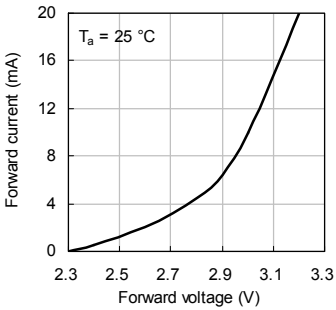

Luminous Intensity vs. Forward Current

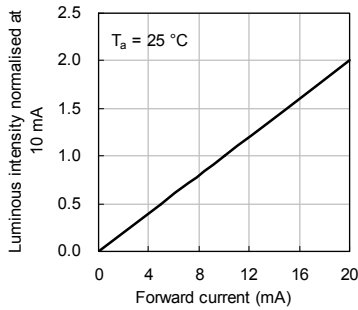

Forward Current Derating Curve

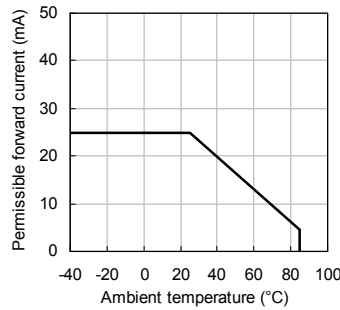

Luminous Intensity vs. Ambient Temperature

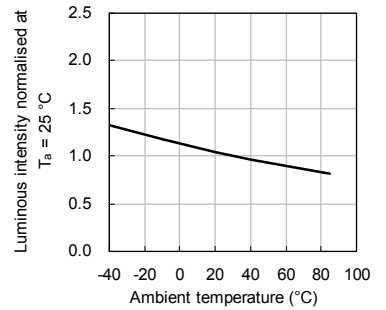

### REFLOW SOLDERING PROFILE for LEAD-FREE SMD PROCESS

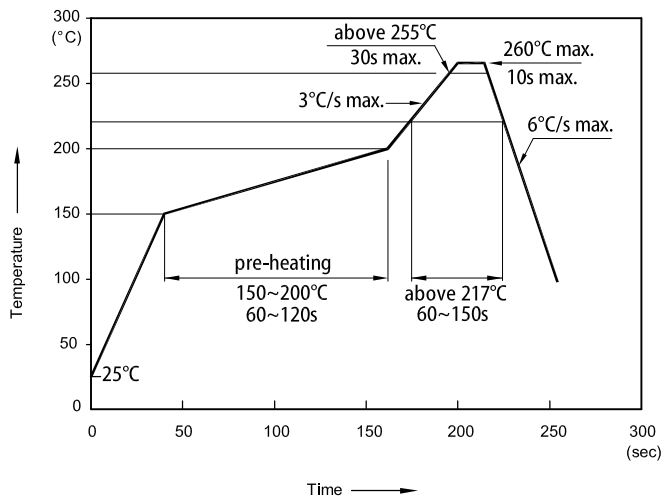

### TAPE SPECIFICATIONS (units: mm)

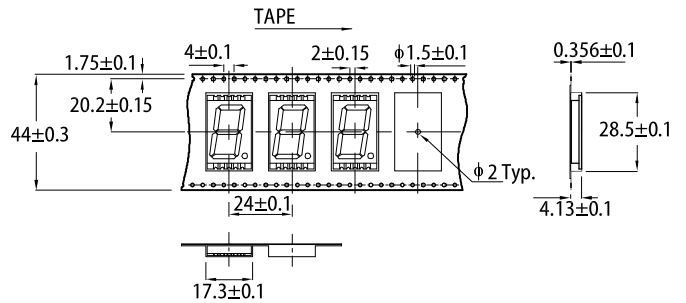

### REEL DIMENSION (units: mm)

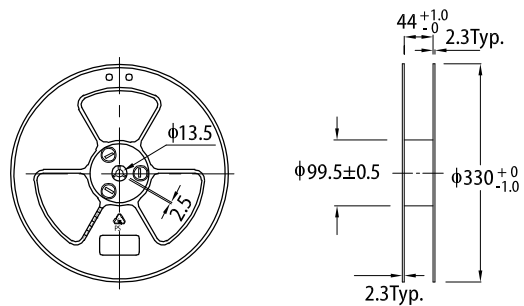

- Notes:
1. Don't cause stress to the LEDs while it is exposed to high temperature.
  2. The maximum number of reflow soldering passes is 2 times.
  3. Reflow soldering is recommended. Other soldering methods are not recommended as they might cause damage to the product.

## PACKING & LABEL SPECIFICATIONS

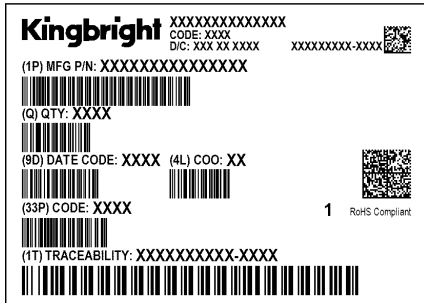
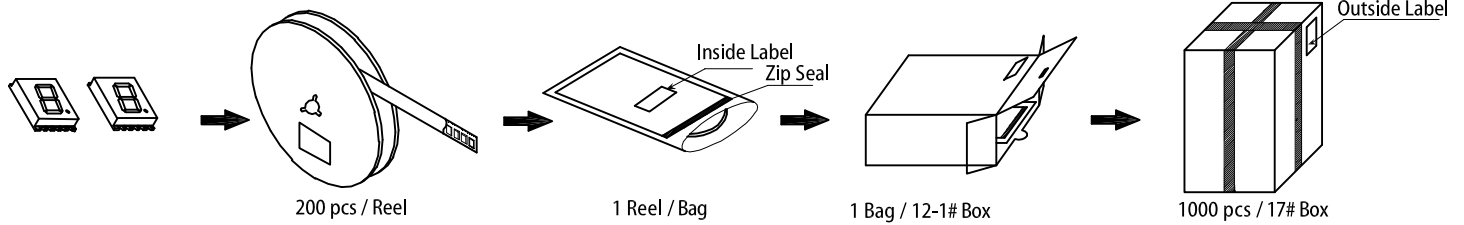

## CIRCUIT DESIGN NOTES

1. Protective current-limiting resistors may be necessary to operate the LEDs within the specified range.
2. LEDs mounted in parallel should each be placed in series with its own current-limiting resistor.
3. The driving circuit should be designed to protect the LED against reverse voltages and transient voltage spikes when the circuit is powered up or shut down.
4. The safe operating current should be chosen after considering the maximum ambient temperature of the operating environment.
5. Prolonged reverse bias should be avoided, as it could cause metal migration, leading to an increase in leakage current or causing a short circuit.

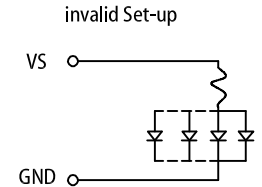
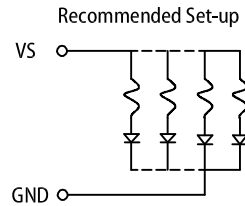

## PRECAUTIONARY NOTES

1. The information included in this document reflects representative usage scenarios and is intended for technical reference only.
2. The part number, type, and specifications mentioned in this document are subject to future change and improvement without notice. Before production usage customer should refer to the latest datasheet for the updated specifications.
3. When using the products referenced in this document, please make sure the product is being operated within the environmental and electrical limits specified in the datasheet. If customer usage exceeds the specified limits, Kingbright will not be responsible for any subsequent issues.
4. The information in this document applies to typical usage in consumer electronics applications. If customer's application has special reliability requirements or have life-threatening liabilities, such as automotive or medical usage, please consult with Kingbright representative for further assistance.
5. The contents and information of this document may not be reproduced or re-transmitted without permission by Kingbright.
6. All design applications should refer to Kingbright application notes available at <http://www.KingbrightUSA.com/ApplicationNotes>