

## AOD413A

### 40V P-Channel MOSFET

#### General Description

The AOD413A uses advanced trench technology and design to provide excellent  $R_{DS(ON)}$  with low gate charge. With the excellent thermal resistance of the DPAK package, this device is well suited for high current load applications.

#### Features

$V_{DS}$  (V) = -40V  
 $I_D$  = -12A ( $V_{GS}$  = -10V)  
 $R_{DS(ON)} < 44m\Omega$  ( $V_{GS}$  = -10V)  
 $R_{DS(ON)} < 66m\Omega$  ( $V_{GS}$  = -4.5V)  
 100% UIS Tested  
 100% Rg Tested

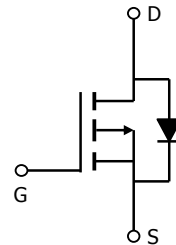
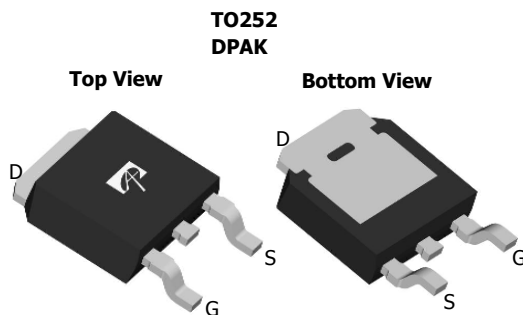

#### Absolute Maximum Ratings $T_A=25^\circ\text{C}$ unless otherwise noted

Parameter	Symbol	Maximum	Units
Drain-Source Voltage	$V_{DS}$	-40	V
Gate-Source Voltage	$V_{GS}$	$\pm 20$	V
Continuous Drain Current <sup>B,H</sup>	$I_D$	$T_C=25^\circ\text{C}$	A
		$T_C=100^\circ\text{C}$	
Pulsed Drain Current <sup>C</sup>	$I_{DM}$	-30	A
Avalanche Current <sup>C</sup>	$I_{AR}$	-20	
Repetitive avalanche energy $L=0.1\text{mH}$ <sup>C</sup>	$E_{AR}$	20	mJ
Power Dissipation <sup>B</sup>	$P_D$	$T_C=25^\circ\text{C}$	W
		$T_C=100^\circ\text{C}$	
Power Dissipation <sup>A</sup>	$P_{DSM}$	$T_A=25^\circ\text{C}$	W
		$T_A=70^\circ\text{C}$	
Junction and Storage Temperature Range	$T_J, T_{STG}$	-55 to 175	$^\circ\text{C}$

#### Thermal Characteristics

Parameter	Symbol	Typ	Max	Units
Maximum Junction-to-Ambient <sup>A,G</sup>	$R_{\theta JA}$	$t \leq 10\text{s}$	16.7	$^\circ\text{C/W}$
Maximum Junction-to-Ambient <sup>A,G</sup>		Steady-State	40	
Maximum Junction-to-Case <sup>F</sup>	$R_{\theta JC}$	2	3	$^\circ\text{C/W}$

Electrical Characteristics (T<sub>J</sub>=25°C unless otherwise noted)

Symbol	Parameter	Conditions	Min	Typ	Max	Units
<b>STATIC PARAMETERS</b>						
BV <sub>DSS</sub>	Drain-Source Breakdown Voltage	I <sub>D</sub> = -250μA, V <sub>GS</sub> =0V	-40			V
I <sub>DSS</sub>	Zero Gate Voltage Drain Current	V <sub>DS</sub> = -40V, V <sub>GS</sub> =0V T <sub>J</sub> =55°C			-1 -5	μA
I <sub>GSS</sub>	Gate-Body leakage current	V <sub>DS</sub> =0V, V <sub>GS</sub> = ±20V			±100	nA
V <sub>GS(th)</sub>	Gate Threshold Voltage	V <sub>DS</sub> =V <sub>GS</sub> I <sub>D</sub> = -250μA	-1.7	-2	-3	V
I <sub>D(ON)</sub>	On state drain current	V <sub>GS</sub> = -10V, V <sub>DS</sub> = -5V	-30			A
R <sub>DS(ON)</sub>	Static Drain-Source On-Resistance	V <sub>GS</sub> = -10V, I <sub>D</sub> = -12A T <sub>J</sub> =125°C		36 52	44 65	mΩ
		V <sub>GS</sub> = -4.5V, I <sub>D</sub> = -8A		52	66	
g <sub>FS</sub>	Forward Transconductance	V <sub>DS</sub> = -5V, I <sub>D</sub> = -12A		22		S
V <sub>SD</sub>	Diode Forward Voltage	I <sub>S</sub> = -1A, V <sub>GS</sub> =0V		-0.76	-1	V
I <sub>S</sub>	Maximum Body-Diode Continuous Current				-12	A
<b>DYNAMIC PARAMETERS</b>						
C <sub>iss</sub>	Input Capacitance	V <sub>GS</sub> =0V, V <sub>DS</sub> = -20V, f=1MHz		900	1125	pF
C <sub>oss</sub>	Output Capacitance			97		pF
C <sub>rss</sub>	Reverse Transfer Capacitance			68		pF
R <sub>g</sub>	Gate resistance	V <sub>GS</sub> =0V, V <sub>DS</sub> =0V, f=1MHz		14		Ω
<b>SWITCHING PARAMETERS</b>						
Q <sub>g</sub> (-10V)	Total Gate Charge	V <sub>GS</sub> = -10V, V <sub>DS</sub> = -20V, I <sub>D</sub> = -12A		16.2	21	nC
Q <sub>g</sub> (-4.5V)	Total Gate Charge			7.2	9.4	nC
Q <sub>gs</sub>	Gate Source Charge			3.8		nC
Q <sub>gd</sub>	Gate Drain Charge			3.5		nC
t <sub>D(on)</sub>	Turn-On DelayTime	V <sub>GS</sub> = -10V, V <sub>DS</sub> = -20V, R <sub>L</sub> =1.6Ω, R <sub>GEN</sub> =3Ω		6.2		ns
t <sub>r</sub>	Turn-On Rise Time			8.4		ns
t <sub>D(off)</sub>	Turn-Off DelayTime			44.8		ns
t <sub>f</sub>	Turn-Off Fall Time			41.2		ns
t <sub>rr</sub>	Body Diode Reverse Recovery Time		I <sub>F</sub> = -12A, dI/dt=100A/μs		21.2	
Q <sub>rr</sub>	Body Diode Reverse Recovery Charge	I <sub>F</sub> = -12A, dI/dt=100A/μs		13.8		nC

A: The value of R<sub>θJA</sub> is measured with the device in a still air environment with T<sub>A</sub>=25°C. The power dissipation P<sub>DSM</sub> and current rating I<sub>DSM</sub> are based on T<sub>J(MAX)</sub>=150°C, using t ≤ 10s junction-to-ambient thermal resistance.

B: The power dissipation P<sub>D</sub> is based on T<sub>J(MAX)</sub>=175°C, using junction-to-case thermal resistance, and is more useful in setting the upper dissipation limit for cases where additional heatsinking is used.

C: Repetitive rating, pulse width limited by junction temperature T<sub>J(MAX)</sub>=175°C.

D: The R<sub>θJA</sub> is the sum of the thermal impedance from junction to case R<sub>θJC</sub> and case to ambient.

E: The static characteristics in Figures 1 to 6 are obtained using <300 μs pulses, duty cycle 0.5% max.

F: These curves are based on the junction-to-case thermal impedance which is measured with the device mounted to a large heatsink, assuming a maximum junction temperature of T<sub>J(MAX)</sub>=175°C. The SOA curve provides a single pulse rating.

G: These tests are performed with the device mounted on 1 in<sup>2</sup> FR-4 board with 2oz. Copper, in a still air environment with T<sub>A</sub>=25°C.

H: The maximum current rating is limited by bond-wires.

\*This device is guaranteed green after data code 8X11 (Sep 1<sup>ST</sup> 2008).

Rev4: April 2011

COMPONENTS IN LIFE SUPPORT DEVICES OR SYSTEMS ARE NOT AUTHORIZED. AOS DOES NOT ASSUME ANY LIABILITY ARISING OUT OF SUCH APPLICATIONS OR USES OF ITS PRODUCTS. AOS RESERVES THE RIGHT TO IMPROVE PRODUCT DESIGN, FUNCTIONS AND RELIABILITY WITHOUT NOTICE.

TYPICAL ELECTRICAL AND THERMAL CHARACTERISTICS

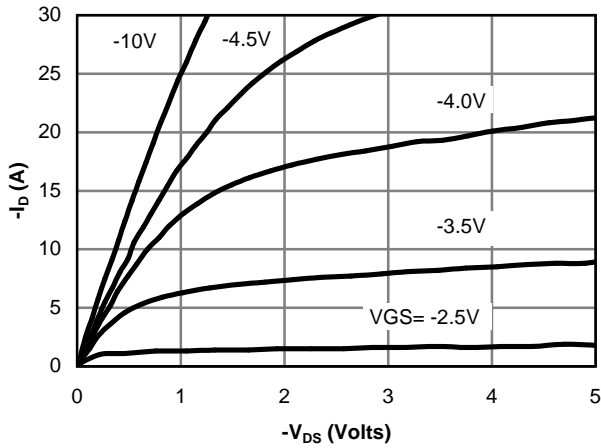

Figure 1: On-Region Characteristics

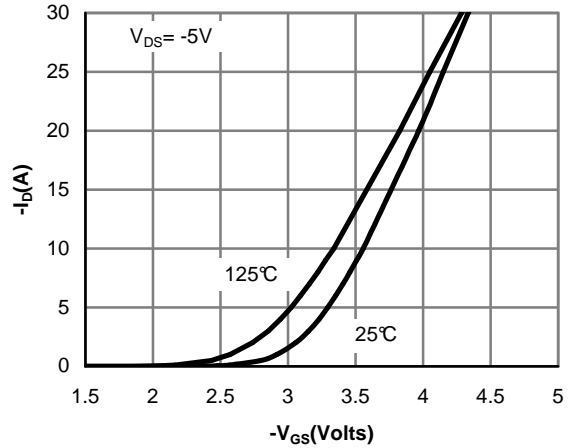

Figure 2: Transfer Characteristics

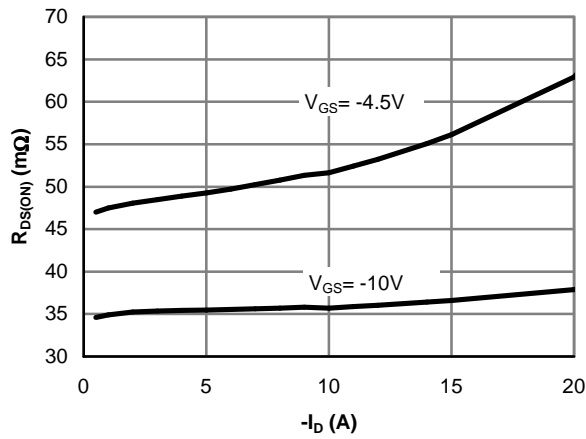

Figure 3: On-Resistance vs. Drain Current and Gate Voltage

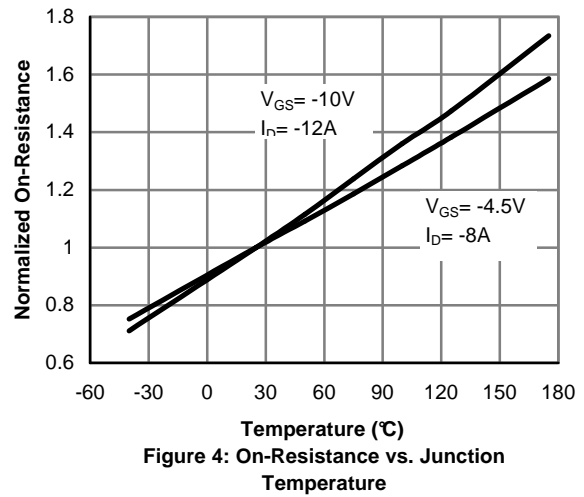

Figure 4: On-Resistance vs. Junction Temperature

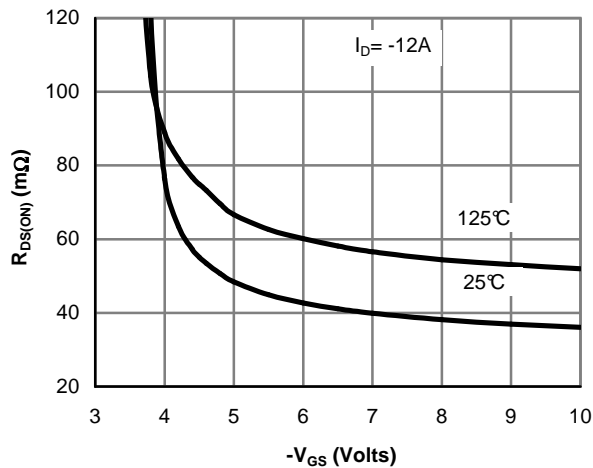

Figure 5: On-Resistance vs. Gate-Source Voltage

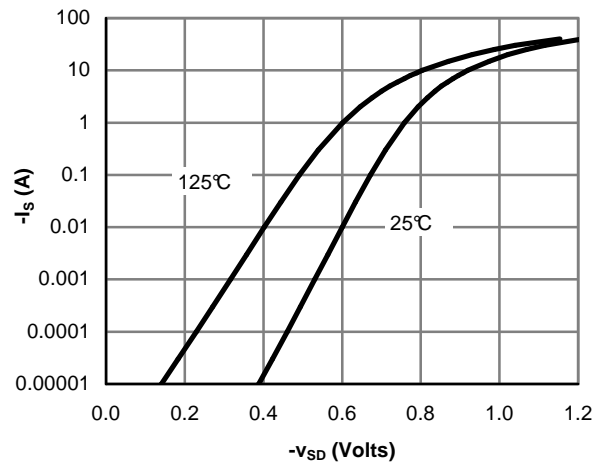

Figure 6: Body-Diode Characteristics

TYPICAL ELECTRICAL AND THERMAL CHARACTERISTICS

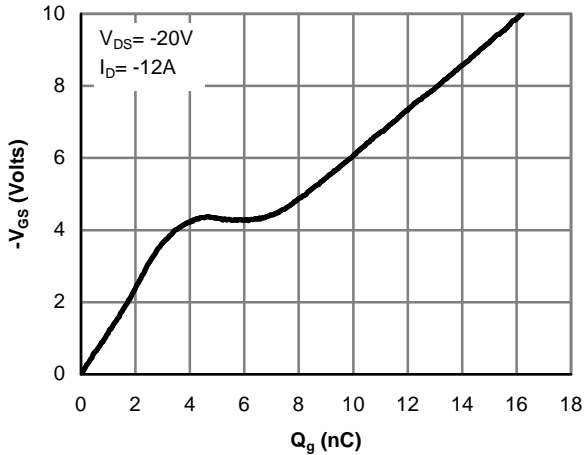

Figure 7: Gate-Charge Characteristics

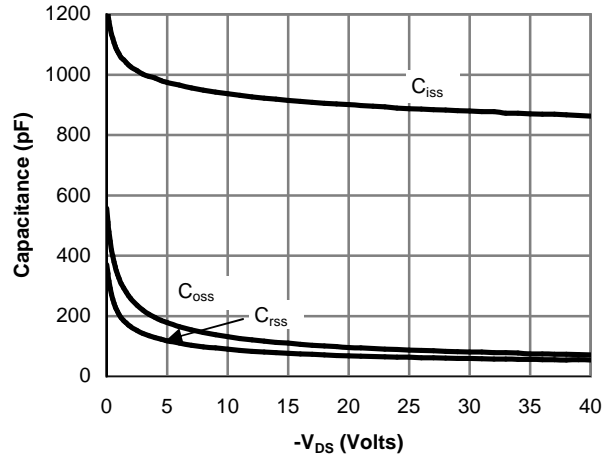

Figure 8: Capacitance Characteristics

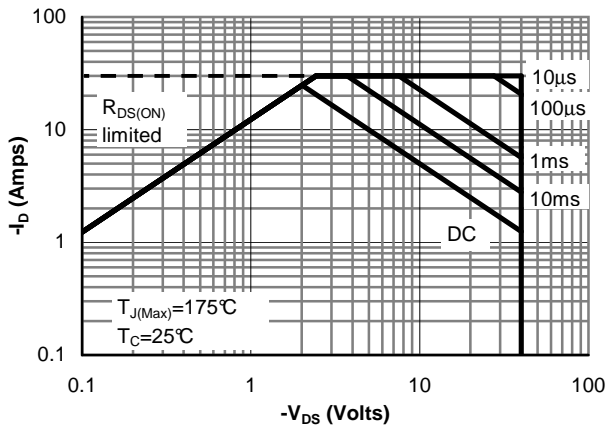

Figure 9: Maximum Forward Biased Safe Operating Area (Note F)

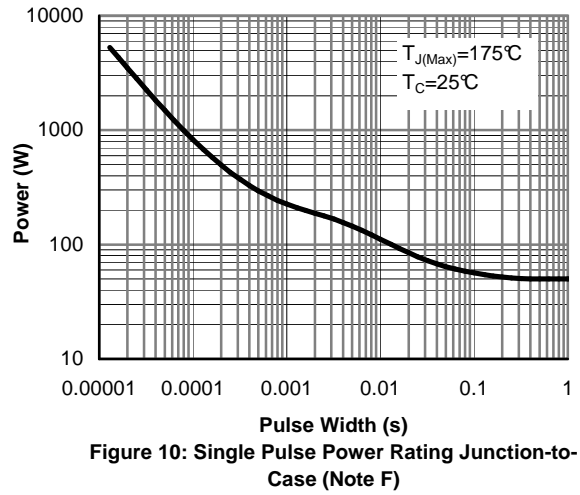

Figure 10: Single Pulse Power Rating Junction-to-Case (Note F)

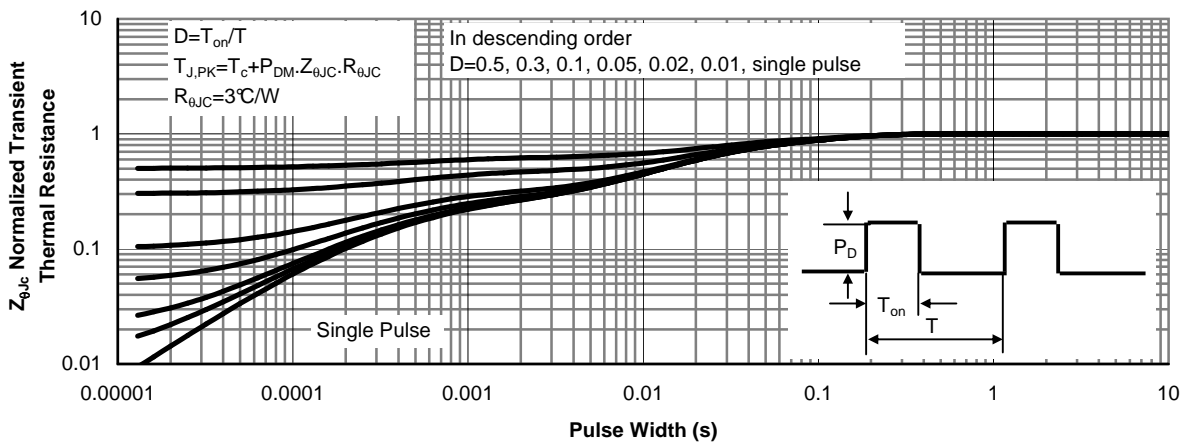

Figure 11: Normalized Maximum Transient Thermal Impedance (Note F)

TYPICAL ELECTRICAL AND THERMAL CHARACTERISTICS

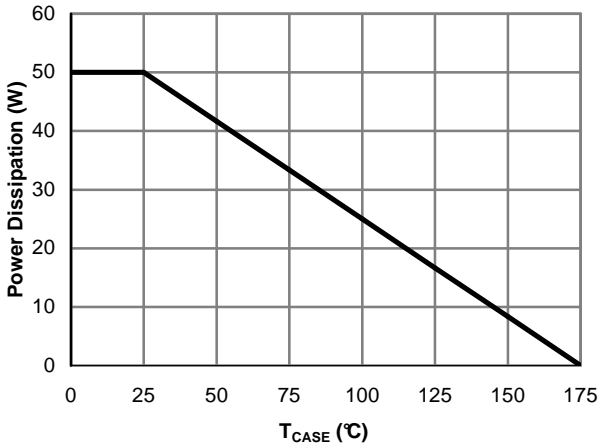

Figure 12: Power De-rating (Note B)

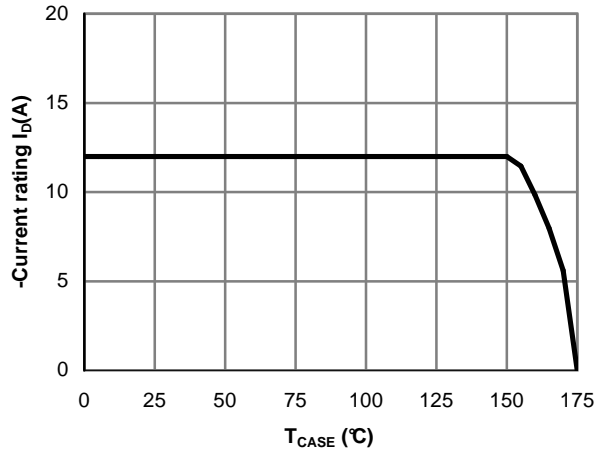

Figure 13: Current De-rating (Note B)

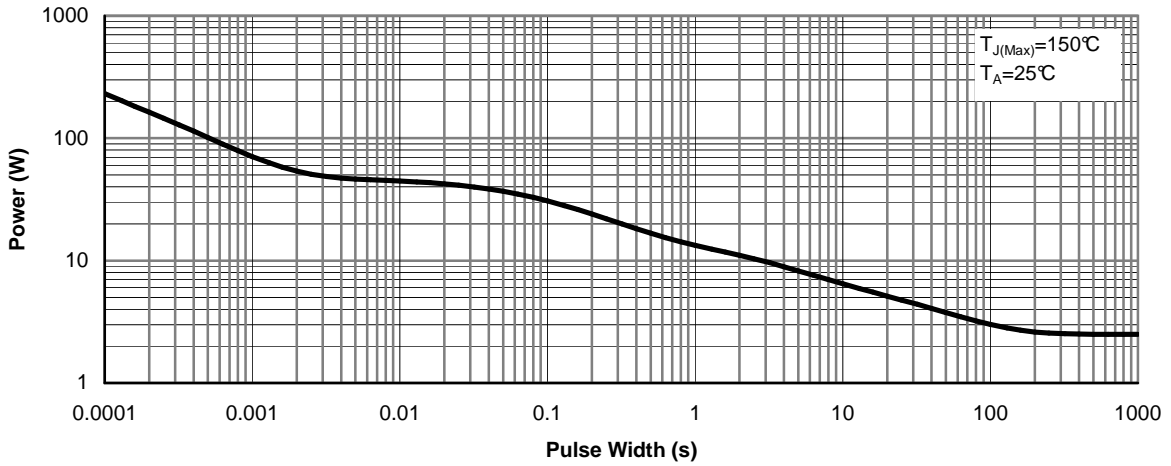

Figure 14: Single Pulse Power Rating Junction-to-Ambient (Note G)

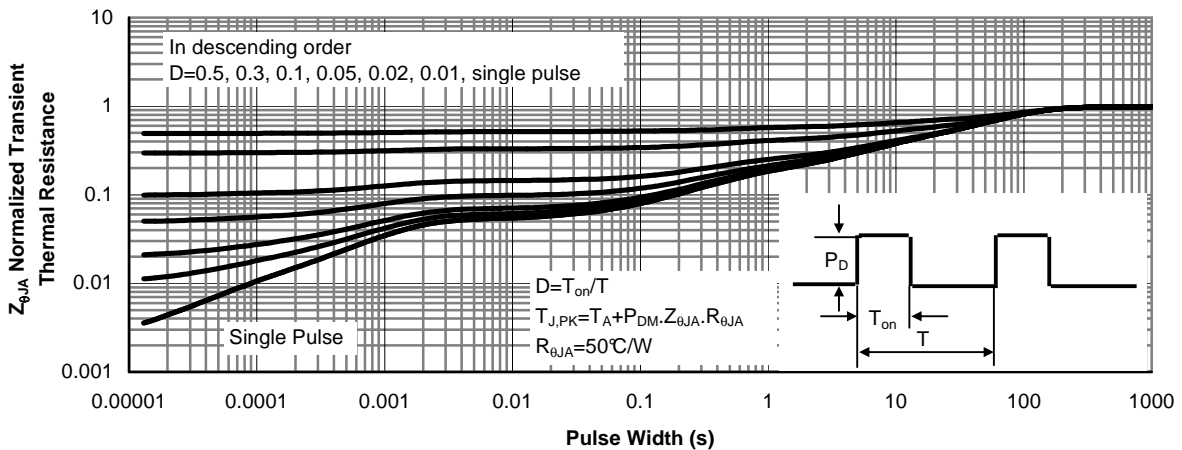
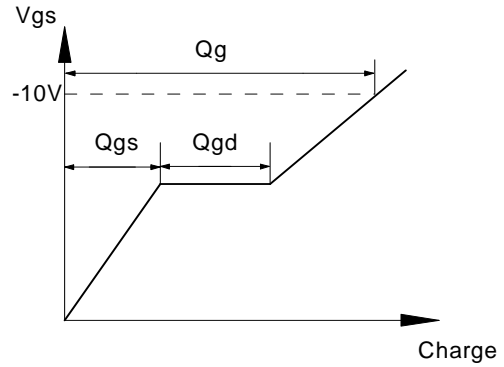
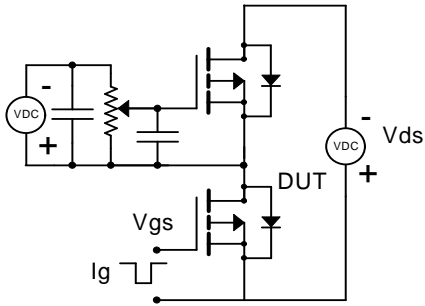
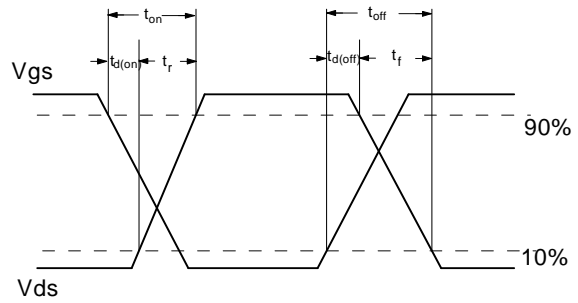
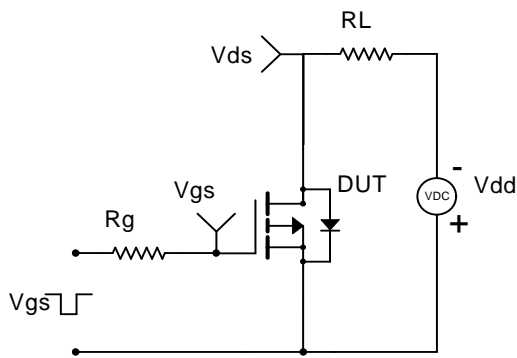

Figure 15: Normalized Maximum Transient Thermal Impedance (Note G)

Gate Charge Test Circuit & Waveform



Resistive Switching Test Circuit & Waveforms



Unclamped Inductive Switching (UIS) Test Circuit & Waveforms

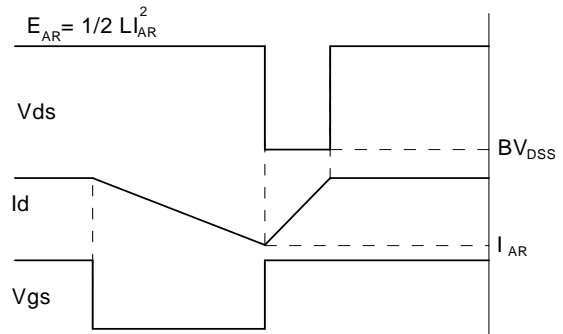
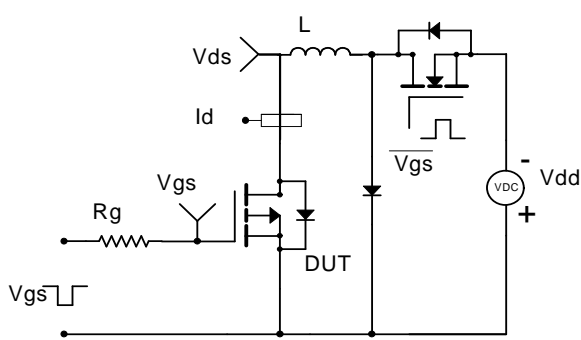

Diode Recovery Test Circuit & Waveforms

