

RoHS Compliant

4GB ECC DDR4 SDRAM UDIMM **Halogen free**

Product Specifications

November 6, 2015

Version 0.2



Apacer Technology Inc.

1F., No.32, Zhongcheng Rd., Tucheng Dist., New Taipei City 236, Taiwan

Tel: +886-2-2267-8000 Fax: +886-2-2267-2261

www.apacer.com

Table of Contents

General Description	2
Ordering Information	2
Key Parameters	2
Specifications:	3
Features:	4
Pin Assignments	5
Pin Descriptions	7
Functional Block Diagram	8
Absolute Maximum Ratings	9
DRAM Component Operating Temperature Range	10
Operating Conditions	11
Mechanical Drawing	12

General Description

Apacer **78.B1GM4.4020B** is a 512M x 72 DDR4 SDRAM (Synchronous DRAM) ECC DIMM. This high-density memory module consists of 9 pieces 512M x 8 bits with 4 banks DDR4 synchronous DRAMs in FBGA packages and a 4K Bits EEPROM. The module is a 288-pins dual in-line memory module and is intended for mounting into a connector socket. The following provides general specifications of this module.

Ordering Information

Part Number	Bandwidth	Speed Grade	Max Frequency	CAS Latency
78.B1GM4.4020B	17 GB/sec	2133 Mbps	1066 MHz	CL15

Density	Organization	Component	Rank
4GB	512M x 72	512M x8*9	1

Key Parameters

MT/s	DDR4-1866	DDR4-2133	DDR4-2400	Unit
Grade	-CL13	-CL15	-CL17	
tCK (min)	1.07	0.93	0.83	ns
CAS latency	13	15	17	tCK
tRCD (min)	13.92	14.06	14.16	ns
tRP (min)	13.92	14.06	14.16	ns
tRAS (min)	34	33	32	ns
tRC (min)	47.92	47.05	46.16	ns
CL-tRCD-tRP	13-13-13	15-15-15	17-17-17	tCK

Specifications:

- ◆ Support ECC error detection and correction
- ◆ On-DIMM thermal sensor : Yes
- ◆ Organization: 512 words x 72 bits, 1 rank
- ◆ Integrating 9 pieces of 4G bits DDR4 SDRAM sealed FBGA
- ◆ Package: 288-pin socket type dual in-line memory module (ECC DIMM)
- ◆ PCB: height 31.25 mm, lead pitch 0.85 mm (pin),
- ◆ Serial Presence Detect (SPD)
- ◆ Power Supply: VDD=1.2V (1.14V to 1.26V)
- ◆ VDDQ = 1.2V (1.14V to 1.26V)
- ◆ VPP = 2.5V (2.375V to 2.75V)
- ◆ VDDSPD = 2.2V to 3.6V
- ◆ 16 internal banks
- ◆ TC of 0°C to 95°C
 - 64ms, 8192-cycle refresh at 0°C to 85°C
 - 32ms at 85°C to 95°C
- ◆ PCB: 30μ gold finger
- ◆ Lead-free (RoHS compliant)
- ◆ Halogen free

Features:

- ◆ Functionality and operations comply with the DDR4 SDRAM datasheet
- ◆ Bank Grouping is applied, and CAS to CAS latency (tCCD_L, tCCD_S) for the banks in the same or different bank group accesses are available
- ◆ Bi-Directional Differential Data Strobe
- ◆ 8 bit pre-fetch
- ◆ Burst Length (BL) switch on-the-fly BL8 or BC4(Burst Chop)
- ◆ Supports ECC error correction and detection
- ◆ Per DRAM Addressability is supported
- ◆ Internal Vref DQ level generation is available
- ◆ Write CRC is supported at all speed grades
- ◆ DBI (Data Bus Inversion) is supported(x8)
- ◆ CA parity (Command/Address Parity) mode is supported

Pin Assignments

Pin No.	Pin name	Pin No.	Pin name	Pin No.	Pin name	Pin No.	Pin name
1	12 V, NC	145	12 V, NC	74	CK0_t	218	CK1_t
2	VSS	146	VREFCA	75	CK0_c	219	CK1_c
3	DQ4	147	VSS	76	VDD	220	VDD
4	VSS	148	DQ5	77	VTT	221	VTT
5	DQ0	149	VSS	78	EVENT_n	222	PARITY
6	VSS	150	DQ1	79	A0	223	VDD
7	TDQS9_t, DQS9_t, DM0_n, DBI0_n, NC	151	VSS	80	VDD	224	BA1
8	TDQS9_c, DQS9_c, NC	152	DQS0_c	81	BA0	225	A10/AP
9	VSS	153	DQS0_t	82	RAS_n/A16	226	VDD
10	DQ6	154	VSS	83	VDD	227	RFU
11	VSS	155	DQ7	84	CS0_n	228	WE_n/A14
12	DQ2	156	VSS	85	VDD	229	VDD
13	VSS	157	DQ3	86	CAS_n/A15	230	NC, SAVE_n
14	DQ12	158	VSS	87	ODT0	231	VDD
15	VSS	159	DQ13	88	VDD	232	A13
16	DQ8	160	VSS	89	CS1_n, NC	233	VDD
17	VSS	161	DQ9	90	VDD	234	NC, A17
18	TDQS10_t, DQS10_t, DM1_n, DBI1_n, NC	162	VSS	91	ODT1, NC	235	NC, C2
19	TDQS10_c, DQS10_c, NC	163	DQS1_c	92	VDD	236	VDD
20	VSS	164	DQS1_t	93	C0, CS2_n, NC	237	NC, CS3_n, C1
21	DQ14	165	VSS	94	VSS	238	SA2
22	VSS	166	DQ15	95	DQ36	239	VSS
23	DQ10	167	VSS	96	VSS	240	DQ37
24	VSS	168	DQ11	97	DQ32	241	VSS
25	DQ20	169	VSS	98	VSS	242	DQ33
26	VSS	170	DQ21	99	TDQS13_t, DQS13_t, DM4_n, DBI4_n, NC	243	VSS
27	DQ16	171	VSS	100	TDQS13_c, DQS13_c, NC	244	DQS4_c
28	VSS	172	DQ17	101	VSS	245	DQS4_t
29	TDQS11_t, DQS11_t, DM2_n, DBI2_n, NC	173	VSS	102	DQ38	246	VSS
30	TDQS11_c, DQS11_c, NC	174	DQS2_c	103	VSS	247	DQ39
31	VSS	175	DQS2_t	104	DQ34	248	VSS
32	DQ22	176	VSS	105	VSS	249	DQ35
33	VSS	177	DQ23	106	DQ44	250	VSS
34	DQ18	178	VSS	107	VSS	251	DQ45
35	VSS	179	DQ19	108	DQ40	252	VSS
36	DQ28	180	VSS	109	VSS	253	DQ41
37	VSS	181	DQ29	110	TDQS14_t, DQS14_t, DM5_n, DBI5_n, NC	254	VSS
38	DQ24	182	VSS	111	TDQS14_c, DQS14_c, NC	255	DQS5_c
39	VSS	183	DQ25	112	VSS	256	DQS5_t

Pin No.	Pin name	Pin No.	Pin name	Pin No.	Pin name	Pin No.	Pin name
40	TDQS12_t, DQS12_t, DM3_n, DBI3_n4, NC	184	VSS	113	DQ46	257	VSS
41	TDQS12_c, DQS12_c, NC	185	DQS3_c	114	VSS	258	DQ47
42	VSS	186	DQS3_t	115	DQ42	259	VSS
43	DQ30	187	VSS	116	VSS	260	DQ43
44	VSS	188	DQ31	117	DQ52	261	VSS
45	DQ26	189	VSS	118	VSS	262	DQ53
46	VSS	190	DQ27	119	DQ48	263	VSS
47	CB4, NC	191	VSS	120	VSS	264	DQ49
48	VSS	192	CB5, NC	121	TDQS15_t, DQS15_t, DM6_n, DBI6_n, NC	265	VSS
49	CB0, NC	193	VSS	122	TDQS15_c, DQS15_c, NC	266	DQS6_c
50	VSS	194	CB1, NC	123	VSS	267	DQS6_t
51	TDQS17_t, DQS17_t, DM8_n, DBI8_n, NC	195	VSS	124	DQ54	268	VSS
52	TDQS17_c, DQS17_c, NC	196	DQS8_c	125	VSS	269	DQ55
53	VSS	197	DQS8_t	126	DQ50	270	VSS
54	CB6, NC	198	VSS	127	VSS	271	DQ51
55	VSS	199	CB7, NC	128	DQ60	272	VSS
56	CB2, NC	200	VSS	129	VSS	273	DQ61
57	VSS	201	CB3, NC	130	DQ56	274	VSS
58	RESET_n	202	VSS	131	VSS	275	DQ57
59	VDD	203	CKE1, NC	132	TDQS16_t, DQS16_t, DM7_n, DBI7_n, NC	276	VSS
60	CKE0	204	VDD	133	TDQS16_c, DQS16_c, NC	277	DQS7_c
61	VDD	205	RFU	134	VSS	278	DQS7_t
62	ACT_n	206	VDD	135	DQ62	279	VSS
63	BG0	207	BG1	136	VSS	280	DQ63
64	VDD	208	ALERT_n	137	DQ58	281	VSS
65	A12/BC_n	209	VDD	138	VSS	282	DQ59
66	A9	210	A11	139	SA0	283	VSS
67	VDD	211	A7	140	SA1	284	VDDSPD
68	A8	212	VDD	141	SCL	285	SDA
69	A6	213	A5	142	VPP	286	VPP
70	VDD	214	A4	143	VPP	287	VPP
71	A3	215	VDD	144	RFU	288	VPP
72	A1	216	A2				
73	VDD	217	VDD				

- Light colored text indicates functions that are not applicable for RDIMM wiring. An example is the NC for pin 56 because RDIMMs defined by this specification will always have DIMM wiring for this pin.

*IC Component Composition :

256Mx8	A0~A13	512Mx4	A0~A14
512Mx8	A0~A14,	1024Mx4	A0~A15
1024Mx8	A0~A15,	2048Mx4	A0~A16
2048Mx8	A0~A16,		

Pin Descriptions

Pin Name	Description
AX ^{1*}	SDRAM address bus
BAX	SDRAM bank select
BGX	SDRAM bank group select
RAS_n ^{2*}	SDRAM row address strobe
CAS_n ^{3*}	SDRAM column address strobe
WE_n ^{4*}	SDRAM write enable
CSx_n	DIMM Rank Select Lines
CKEx	SDRAM clock enable lines
ODTx	SDRAM on-die termination control lines
ACT_n	SDRAM input for activate input
DQx	DIMM memory data bus
CBx	DIMM ECC check bits
TDQSx_t ; TDQSx_c	Dummy loads for mixed populations of x4 based and x8 based RDIMMs. Not used on UDIMMs
DQSx_t	Data Buffer data strobes (positive line of differential pair)
DQSx_c	Data Buffer data strobes (negative line of differential pair)
DMx_n, DBlx_n	SDRAM data masks/data bus inversion(x8-based x72 DIMMs)
CKx_t	SDRAM clock input (positive line of differential pair)
CKx_c	SDRAM clocks input (negative line of differential pair)
SCL	I ² C serial bus clock for SPD-TSE and register
SDA	I ² C serial bus data line for SPD-TSE and register
SAX	I ² C slave address select for SPD-TSE and register
PARITY	SDRAM parity input
VDD	SDRAM core power supply
12 V	Optional Power Supply on socket but not used on DIMM
VREFCA	SDRAM command/address reference supply
VSS	Power supply return (ground)
VDDSPD	Serial SPD-TSE positive power supply
ALERT_n	SDRAM ALERT_n output
VPP	SDRAM Supply
RESET_n	Set Register and SDRAMs to a Known State
EVENT_n	SPD signals a thermal event has occurred
VTT	SDRAM I/O termination supply
RFU	Reserved for future use

*Notes:

1. Address A17 is only valid for 16 Gb x4 based SDRAMs. For UDIMMs this connection pin is NC.
2. RAS_n is a multiplexed function with A16.
3. CAS_n is a multiplexed function with A15.
4. WE_n is a multiplexed function with A14.

Functional Block Diagram

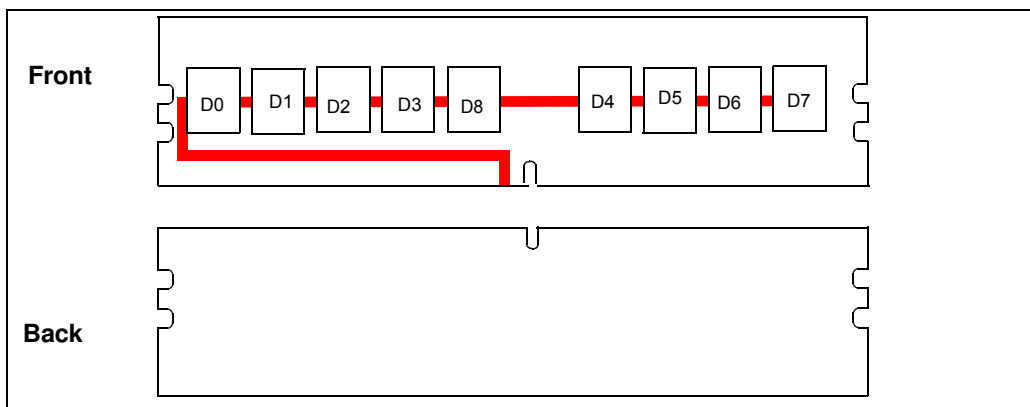
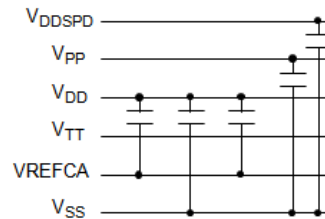
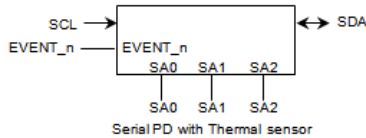
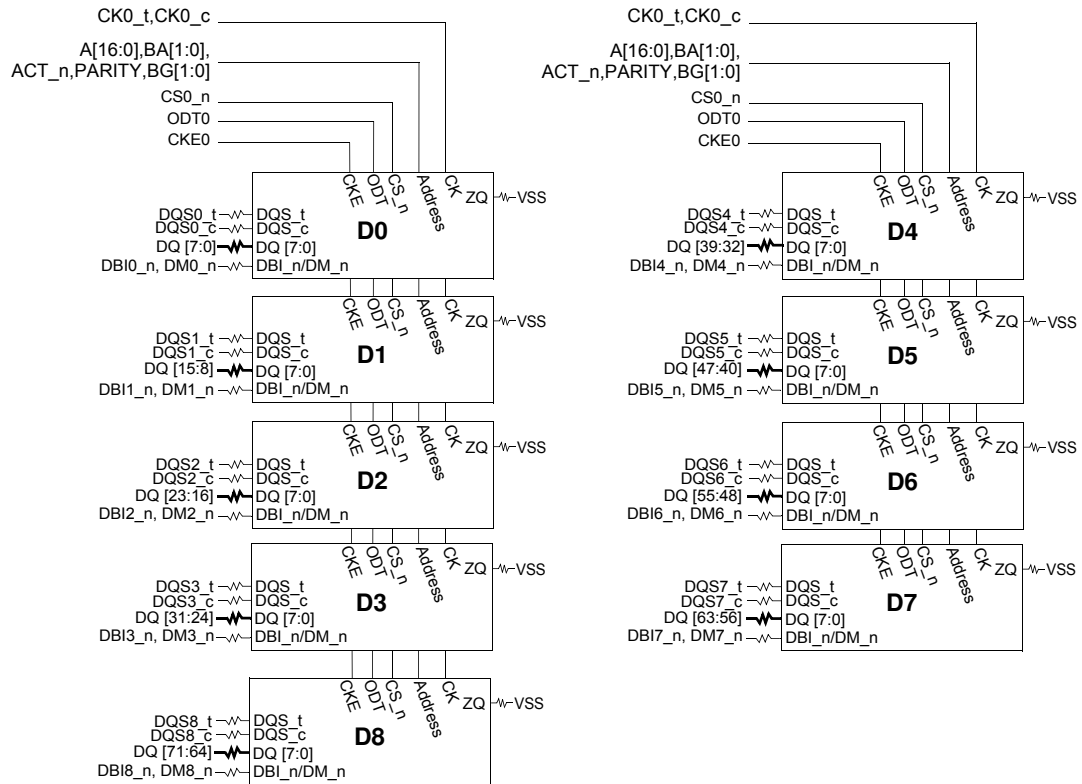

Address, Command and Control lines

- Note 1:** CK1_t, CK1_c terminated with $75 \Omega \pm 5\%$ resistor.
- Note 2:** Unless otherwise noted resistors are $15 \Omega \pm 5\%$.
- Note 3:** ZQ resistors are $240 \Omega \pm 1\%$. For all other resistor values refer to the appropriate wiring diagram.
- Note 4:** Event_n is used for SPD with TS. Option Resistor for it should be placed.

Absolute Maximum Ratings

Parameter	Symbol	Description	Units	Notes
Voltage on VDD pin relative to Vss	V _{DD}	- 0.3 V ~ 1.5 V	V	1,3
Voltage on VDDQ pin relative to Vss	V _{DDQ}	- 0.3 V ~ 1.5 V	V	1,3
Voltage on VPP pin relative to Vss	V _{PP}	- 0.3 V ~ 3.0 V	V	4
Voltage on any pin relative to Vss	V _{IN} , V _{OUT}	- 0.3 V ~ 3.0 V	V	1
Storage Temperature	T _{STG}	-55 to +100	°C	1,2

Notes:

1. Stresses greater than those listed under "Absolute Maximum Ratings" may cause permanent damage to the device. This is a stress rating only and functional operation of the device at these or any other conditions above those indicated in the operational sections of this specification is not implied. Exposure to absolute maximum rating conditions for extended periods may affect reliability.
2. Storage Temperature is the case surface temperature on the center/top side of the DRAM. For the measurement conditions, please refer to JESD51-2 standard.
3. VDD and VDDQ must be within 300 mV of each other at all times; and VREFCA must be not greater than 0.6 x VDDQ, When VDD and VDDQ are less than 500 mV; VREF may be equal to or less than 300 mV
4. VPP must be equal or greater than VDD/VDDQ at all times

DRAM Component Operating Temperature Range

Symbol	Parameter	Rating	Units	Notes
TOPER	Normal Operating Temperature Range	0 to 85	°C	1,2
	Extended Temperature Range	85 to 95	°C	1,3

Notes:

1. Operating Temperature TOPER is the case surface temperature on the center / top side of the DRAM. For measurement conditions please refer to the JEDEC document JESD51-2.
2. The Normal Temperature Range specifies the temperatures where all DRAM specifications will be supported. During operation, the DRAM case temperature must be maintained between 0°C - 85°C under all operating conditions.
3. Some applications require operation of the DRAM in the Extended Temperature Range between 85°C and 95°C case temperature. Full specifications are guaranteed in this range, but the following additional conditions apply:
 - a. Refresh commands must be doubled in frequency, therefore reducing the Refresh interval tREFI to 3.9 μs. It is also possible to specify a component with 1X refresh (tREFI to 7.8μs) in the Extended Temperature Range. Please refer to the DIMM SPD for option availability
 - b. If Self-Refresh operation is required in the Extended Temperature Range, then it is mandatory to either use the Manual Self-Refresh mode with Extended Temperature Range capability (MR2 A6 = 0b and MR2 A7 = 1b), in this case IDD6 current can be increased around 10~20% than normal Temperature range.

Operating Conditions

Recommended DC Operating Conditions – DDR4 (1.2V) operation

Symbol	Parameter	Rating			Units	Notes
		Min.	Typ.	Max.		
VDD	Supply Voltage	1.14	1.2	1.26	V	1,2,3
VDDQ	Supply Voltage for Output	1.14	1.2	1.26	V	1,2,3
VPP	Activation Supply Voltage	2.375	2.5	2.75	V	3

Notes:

1. Under all conditions VDDQ must be less than or equal to VDD..
2. VDDQ tracks with VDD. AC parameters are measured with VDD and VDDQ tied together.
3. DC bandwidth is limited to 20MHz.

Mechanical Drawing

Unit: mm

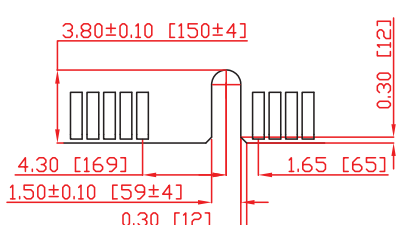
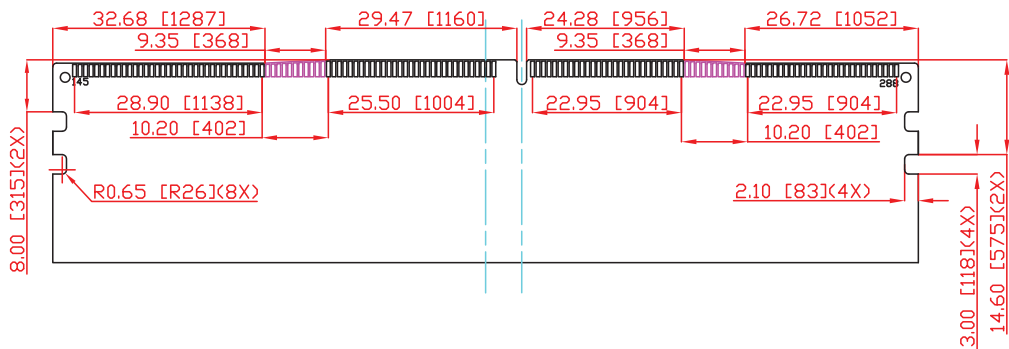
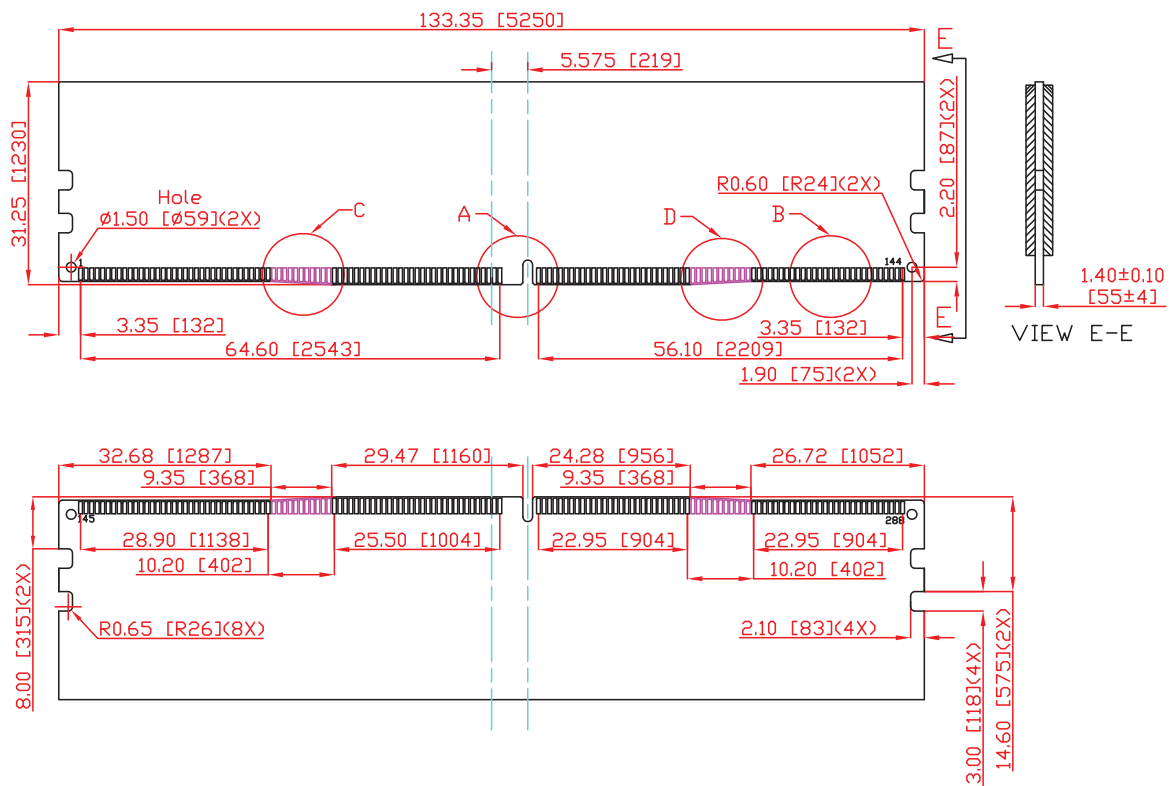

Detail A

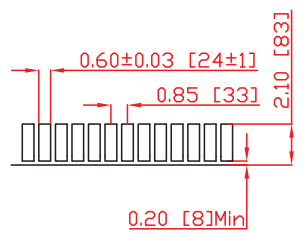

Detail B

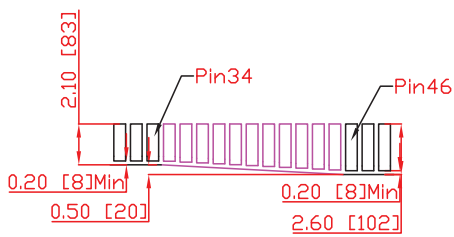

Detail C

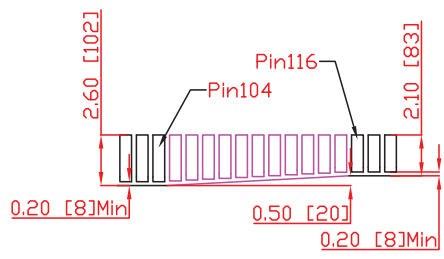

Detail D

30μ gold finger

(All dimensions are in millimeters with ±0.15mm tolerance unless specified otherwise.)

Revision History

Revision	Date	Description	Remark
0.1	5/5/2014	Initial release	
0.2	11/2/2015	Updated VDDSPD	

Global Presence

Taiwan (Headquarters)

Apacer Technology Inc.

1F., No.32, Zhongcheng Rd., Tucheng Dist.,

New Taipei City 236, Taiwan R.O.C.

Tel: +886-2-2267-8000

Fax: +886-2-2267-2261

amtsales@apacer.com

U.S.A.

Apacer Memory America, Inc.

46732 Lakeview Blvd., Fremont, CA 94538

Tel: 1-408-518-8699

Fax: 1-510-249-9568

sa@apacerus.com

Japan

Apacer Technology Corp.

5F, Matsura Bldg., Shiba, Minato-Ku

Tokyo, 105-0014, Japan

Tel: 81-3-5419-2668

Fax: 81-3-5419-0018

jpservices@apacer.com

Europe

Apacer Technology B.V.

Science Park Eindhoven 5051 5692 EB Son,

The Netherlands

Tel: 31-40-267-0000

Fax: 31-40-290-0686

sales@apacer.nl

China

Apacer Electronic (Shanghai) Co., Ltd.

Room D, 22/FL, No.2, Lane 600, JieyunPlaza,

Tianshan RD , Shanghai , 200051, China

Tel: 86-21-6228-9939

Fax: 86-21-6228-9936

sales@apacer.com.cn

India

Apacer Technologies Pvt Ltd.

Unit No.201, "Brigade Corner", 7th Block Jayanagar, Yediyur

Circle, Bangalore – 560082, India

Tel: 91-80-4152-9061

Fax: 91-80-4170-0215

sales_india@apacer.com