

280593 ✓ ACTIVE

AMPMODU | AMPMODU MOD 1

TE Internal #: 280593

Housing, Receptacle, 8 Position, .156 in [3.96 mm] Centerline, 1

Row, Green, AMPMODU MOD 1

[View on TE.com >](#)



Connectors > PCB Connectors > Wire-to-Board Connectors > Wire-to-Board Connector Assemblies & Housings

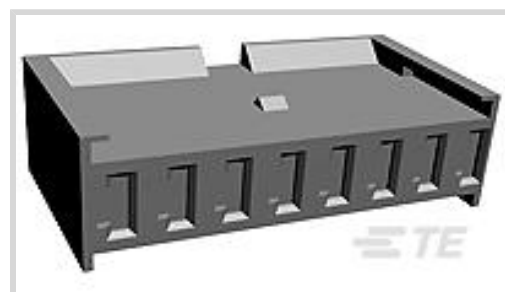

Connector Product Type: **Housing**

Connector & Housing Type: **Receptacle**

Number of Positions: **8**

Centerline (Pitch): **3.96 mm [.156 in]**

Number of Rows: **1**

## Features

### Product Type Features

Connector Product Type	Housing
Connector & Housing Type	Receptacle

### Configuration Features

Number of Positions	8
Number of Rows	1

### Body Features

Connector Profile	Standard
Primary Product Color	Green

### Contact Features

Contact Type	Socket
--------------	--------

### Housing Features

Housing Material	Polycarbonate GFF
Centerline (Pitch)	3.96 mm [.156 in]

### Industry Standards

UL Flammability Rating	UL 94V-1
------------------------	----------

## Product Compliance

[For compliance documentation, visit the product page on TE.com>](#)







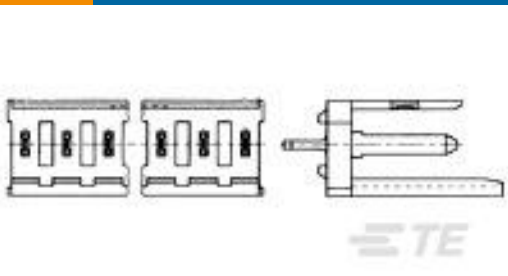
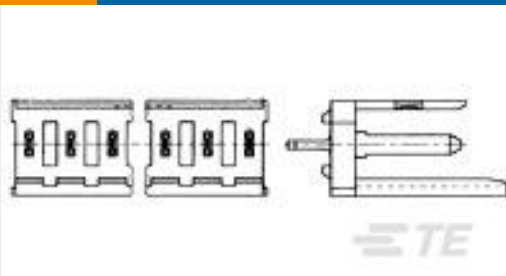
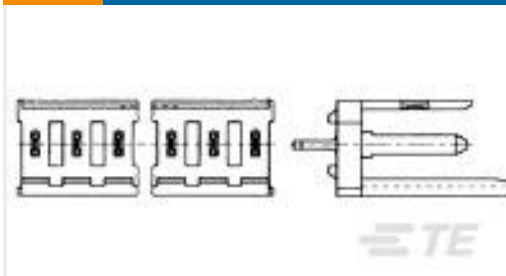

EU RoHS Directive 2011/65/EU	Compliant
EU ELV Directive 2000/53/EC	Compliant
China RoHS 2 Directive MIIT Order No 32, 2016	No Restricted Materials Above Threshold
EU REACH Regulation (EC) No. 1907/2006	Current ECHA Candidate List: JUNE 2023 (235) Candidate List Declared Against: JUNE 2023 (235) Does not contain REACH SVHC
Halogen Content	Low Halogen - Br, Cl, F, I < 900 ppm per homogenous material. Also BFR/CFR/PVC Free
Solder Process Capability	Not applicable for solder process capability

Product Compliance Disclaimer

This information is provided based on reasonable inquiry of our suppliers and represents our current actual knowledge based on the information they provided. This information is subject to change. The part numbers that TE has identified as EU RoHS compliant have a maximum concentration of 0.1% by weight in homogenous materials for lead, hexavalent chromium, mercury, PBB, PBDE, DBP, BBP, DEHP, DIBP, and 0.01% for cadmium, or qualify for an exemption to these limits as defined in the Annexes of Directive 2011/65/EU (RoHS2). Finished electrical and electronic equipment products will be CE marked as required by Directive 2011/65/EU. Components may not be CE marked. Additionally, the part numbers that TE has identified as EU ELV compliant have a maximum concentration of 0.1% by weight in homogenous materials for lead, hexavalent chromium, and mercury, and 0.01% for cadmium, or qualify for an exemption to these limits as defined in the Annexes of Directive 2000/53/EC (ELV). Regarding the REACH Regulation, the information TE provides on SVHC in articles for this part number is based on the latest European Chemicals Agency (ECHA) 'Guidance on requirements for substances in articles' posted at this URL: <https://echa.europa.eu/guidance-documents/guidance-on-reach>

## Compatible Parts

 <p>TE Part # 280612-2 8P MOD 1 SHROUDED HEADER, ST, 0.4 Au</p>	 <p>TE Part # 280612-1 8P MOD 1 SHROUDED HEADER, ST, TIN PLTD</p>	 <p>TE Part # 280618-2 MOD 1 INCREMENTAL ASSY</p>	 <p>TE Part # 280621-2 MOD 1 CONT STRIP</p>
 <p>TE Part # 280621-1 MOD 1 CRIMP CONTACT</p>	 <p>TE Part # 280702-1 AMPMODU CONT.</p>	 <p>TE Part # 85488-7 MOD 1 RECP PLTD 30 SEL</p>	 <p>TE Part # 181299-2 MOD 1 CONTACT REC</p>

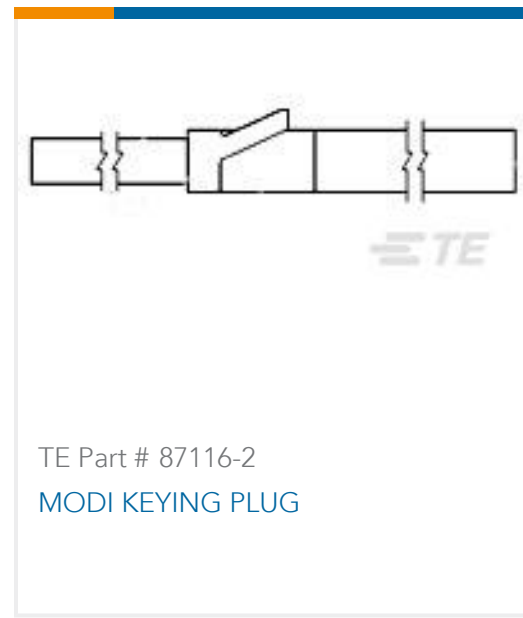
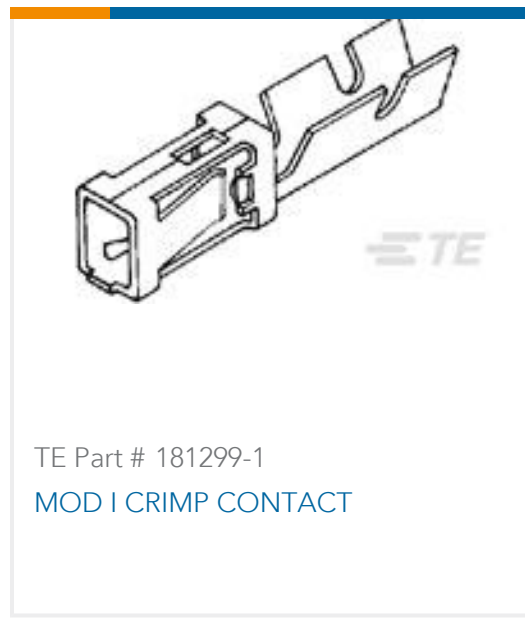

Also in the Series | **AMPMODU MOD 1**

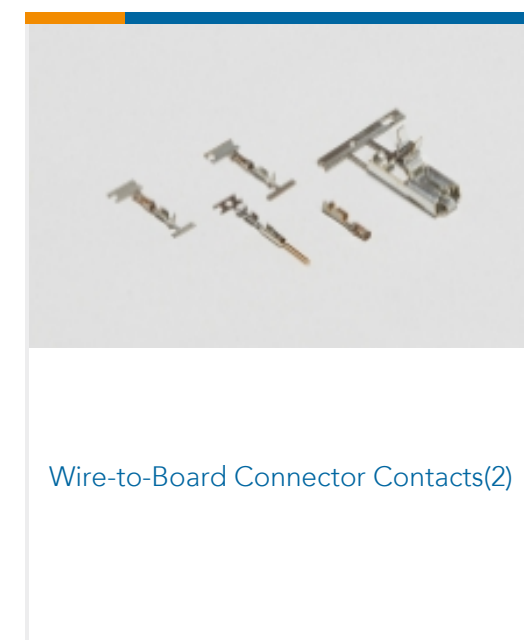
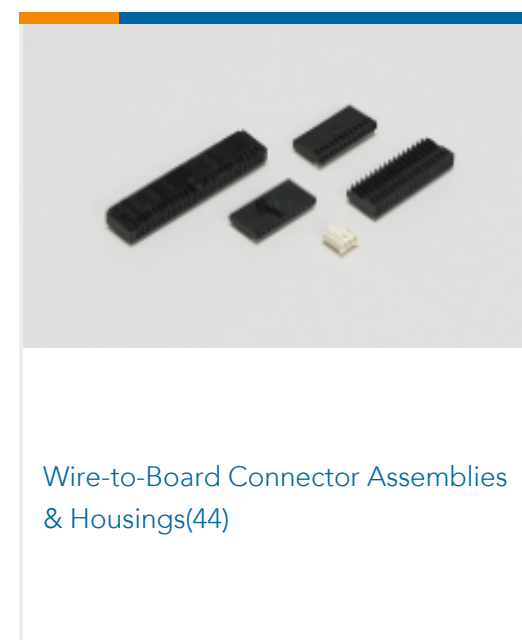
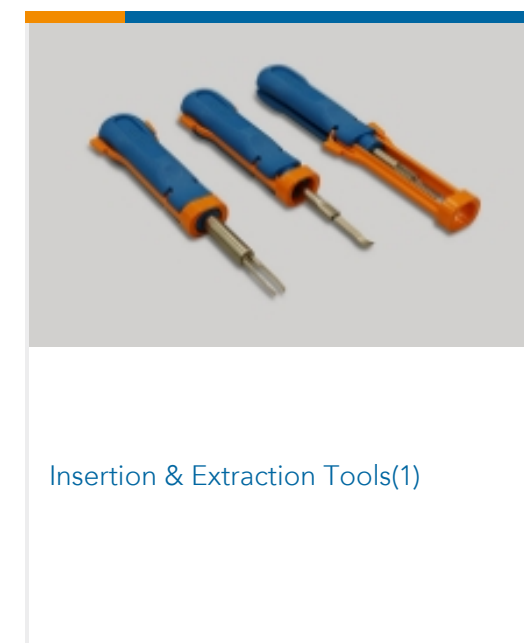
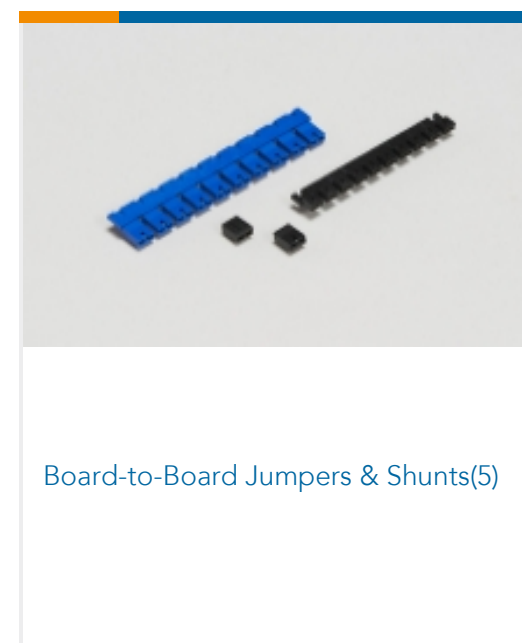
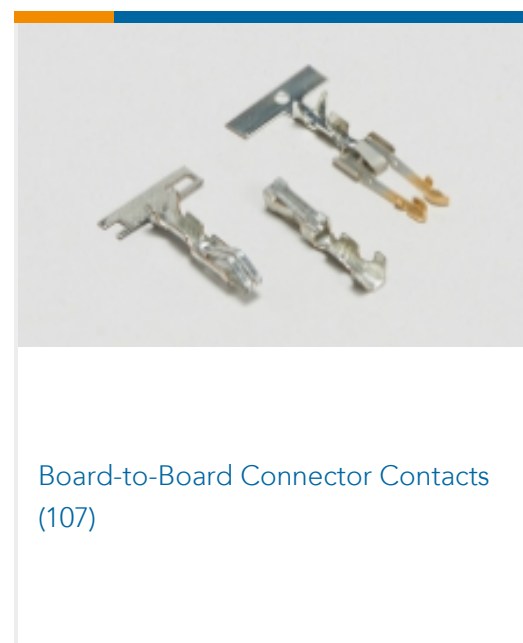
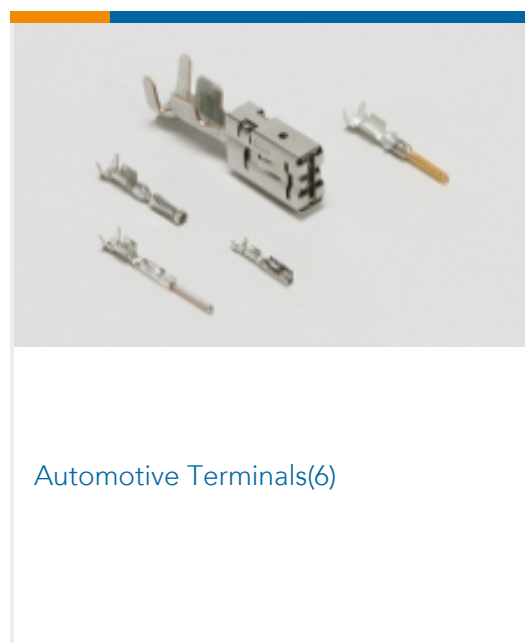

Customers Also Bought

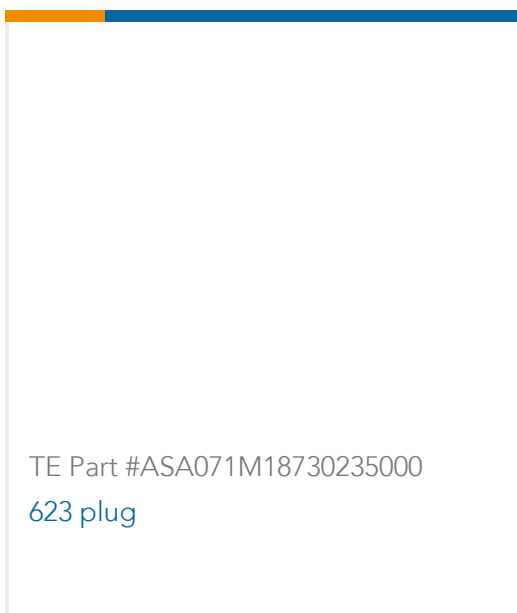
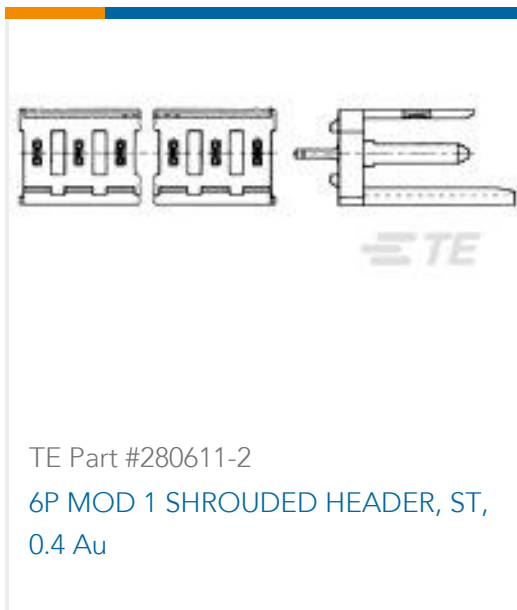

## Documents

### Product Drawings

[AMP MODU MOD I RECEPT HSG](#)

English

### CAD Files

[3D PDF](#)

English

**Customer View Model**

[ENG\\_CVM\\_280593\\_G.3d\\_igs.zip](#)

English

**Customer View Model**

[ENG\\_CVM\\_280593\\_G.3d\\_stp.zip](#)

English

**Customer View Model**

[ENG\\_CVM\\_280593\\_G.2d\\_dxf.zip](#)

English

By downloading the CAD file I accept and agree to the [Terms and Conditions](#) of use.

## Product Specifications



**Product Specification**

English

---

**Product Environmental Compliance**

**Product Compliance**

English

**Product Compliance**

English

---

**Agency Approvals**

**UL Report**

English