

200mA Dual Output AMOLED Display Power

Check for Samples: [TPS65137](#)

FEATURES

- 2.3 V to 5.5 V Input Voltage Range
- 1% Output Voltage Accuracy V_{POS}
- Excellent Line Transient Regulation
- Low Noise Operation
- 200 mA Output Current
- Fixed 4.63 V Positive Output Voltage
- Digitally Programmable Negative Output Voltage Down to $-5.23V$
- $-4.93V$ Default Value for V_{NEG}
- Advanced Power Save Mode
- Short Circuit Protection
- Thermal Shutdown
- TPS65137A High impedance output in shutdown
- 3x3 mm 10 Pin QFN Package

DESCRIPTION

The TPS65137 is designed to provide best in class picture quality for AMOLED displays (Active Matrix Organic Light Emitting Diode) requiring positive and negative voltage supply rails. With its wide input voltage range the device is ideally suited for AMOLED displays, which are used in mobile phones and smart phones. With this device the input voltage can be higher than the positive output voltage and still maintains accurate regulation of V_{POS} . Using the digital control pin (CTRL) allows adjusting the negative output voltage in digital steps. The TPS65137 uses a novel technology enabling excellent line and load regulation with minimum output voltage ripple by using a LDO post regulator for V_{POS} . This is required avoiding disturbance of the AMOLED display due to input voltage transients occurring during transmit periods in mobile phones.

APPLICATIONS

- Active Matrix OLED Power Supply

TYPICAL APPLICATION

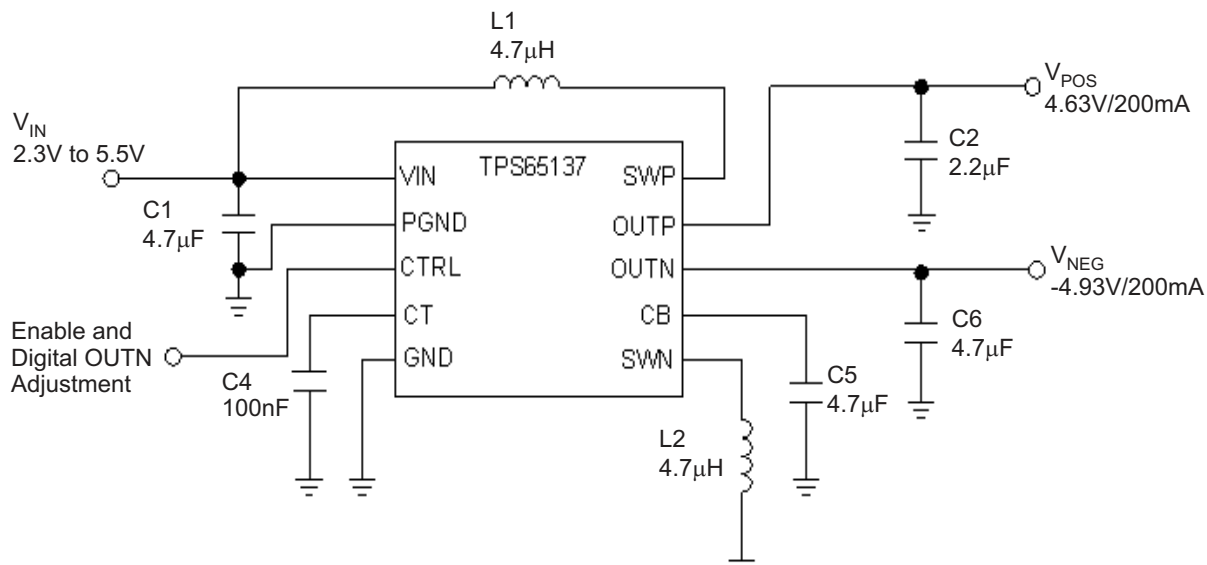

Please be aware that an important notice concerning availability, standard warranty, and use in critical applications of Texas Instruments semiconductor products and disclaimers thereto appears at the end of this data sheet.



This integrated circuit can be damaged by ESD. Texas Instruments recommends that all integrated circuits be handled with appropriate precautions. Failure to observe proper handling and installation procedures can cause damage.

ESD damage can range from subtle performance degradation to complete device failure. Precision integrated circuits may be more susceptible to damage because very small parametric changes could cause the device not to meet its published specifications.

ORDERING INFORMATION^{(1) (2)}

T _A	ORDERING P/N	PACKAGE MARKING
–40°C to 85°C	TPS65137A	PTTI

- (1) For the most current package and ordering information, see the Package Option Addendum at the end of this document, or visit the device product folder on ti.com.
- (2) Contact the factory for the availability of the TPS65137 with output voltage discharge function.

ABSOLUTE MAXIMUM RATINGS

over operating free-air temperature range (unless otherwise noted)⁽¹⁾

		VALUE		UNIT
		MIN	MAX	
Input voltage range ⁽²⁾	V _{IN}	–0.3	7.0	V
	CTRL, SWP, OUTP	–0.3	7.0	
	SWP, OUTP	–0.3	7.0	
	OUTN	+0.3	–5.5	
	CB	–0.3	7.0	
	CT	–0.3	3.6	
ESD rating	HBM		2	kV
	MM		200	V
	CDM		500	V
Continuous total power dissipation		See Thermal Information Table		
Operating junction temperature range	T _J	–40	150	°C
Operating ambient temperature range	T _A	–40	85	°C
Storage temperature range	T _{stg}	–65	150	°C

- (1) Stresses beyond those listed under *absolute maximum ratings* may cause permanent damage to the device. These are stress ratings only, and functional operation of the device at these or any other conditions beyond those indicated under *recommended operating conditions* is not implied. Exposure to absolute–maximum–rated conditions for extended periods may affect device reliability.
- (2) All voltage values are with respect to network ground terminal.

THERMAL INFORMATION

THERMAL METRIC ⁽¹⁾		TPS65137		UNITS
		DSC		
		10		
θ_{JA}	Junction-to-ambient thermal resistance ⁽²⁾	56.5		°C/W
$\theta_{JC(top)}$	Junction-to-case(top) thermal resistance ⁽³⁾	65.8		
θ_{JB}	Junction-to-board thermal resistance ⁽⁴⁾	25.2		
ψ_{JT}	Junction-to-top characterization parameter ⁽⁵⁾	1.0		
ψ_{JB}	Junction-to-board characterization parameter ⁽⁶⁾	17.9		
$\theta_{JC(bottom)}$	Junction-to-case(bottom) thermal resistance ⁽⁷⁾	2.5		

- (1) For more information about traditional and new thermal metrics, see the *IC Package Thermal Metrics* application report, [SPRA953](#).
- (2) The junction-to-ambient thermal resistance under natural convection is obtained in a simulation on a JEDEC-standard, high-K board, as specified in JESD51-7, in an environment described in JESD51-2a.
- (3) The junction-to-case (top) thermal resistance is obtained by simulating a cold plate test on the package top. No specific JEDEC-standard test exists, but a close description can be found in the ANSI SEMI standard G30-88.
- (4) The junction-to-board thermal resistance is obtained by simulating in an environment with a ring cold plate fixture to control the PCB temperature, as described in JESD51-8.
- (5) The junction-to-top characterization parameter, ψ_{JT} , estimates the junction temperature of a device in a real system and is extracted from the simulation data for obtaining θ_{JA} , using a procedure described in JESD51-2a (sections 6 and 7).
- (6) The junction-to-board characterization parameter, ψ_{JB} , estimates the junction temperature of a device in a real system and is extracted from the simulation data for obtaining θ_{JA} , using a procedure described in JESD51-2a (sections 6 and 7).
- (7) The junction-to-case (bottom) thermal resistance is obtained by simulating a cold plate test on the exposed (power) pad. No specific JEDEC standard test exists, but a close description can be found in the ANSI SEMI standard G30-88.

RECOMMENDED OPERATING CONDITIONS⁽¹⁾

		MIN	NOM	MAX	UNIT
V_{IN}	Input voltage range	2.3		5.5	V
T_A	Operating ambient temperature	-40		+85	°C
T_J	Operating junction temperature	-40		+125	°C

- (1) Refer to application section for further information.

ELECTRICAL CHARACTERISTICS

$V_{IN} = 3.5V$, $EN = VIN$, $OUTP = 4.63V$, $OUTN = -4.93V$, $T_A = -40^{\circ}C$ to $85^{\circ}C$, typical values are at $T_A = 25^{\circ}C$ (unless otherwise noted)

PARAMETER		TEST CONDITIONS	MIN	TYP	MAX	UNIT
SUPPLY CURRENT						
V_{IN}	Input voltage range		2.3		5.5	V
I_Q	Operating quiescent current into Vin			400		μA
I_{SD}	Shutdown current into Vin			0.1	1.0	μA
UVLO	Under-voltage lockout threshold	V_{IN} falling			2.0	V
		V_{IN} rising			2.3	
f_s	Switching frequency	$I_{out} = 100\text{ mA}$		1.6		MHz
	Thermal shutdown			145		$^{\circ}C$
	Thermal shutdown hysteresis			10		$^{\circ}C$
OUTPUT OUTP						
V_{POS}	Positive output voltage regulation	$V_{IN} = 2.3V$ to $5.5V$, $I_{load} = 0mA$ to $150mA$	-1%	4.63	1%	V
I_{outP}	Output current OUTP		200			mA
$R_{DS(ON)}$	SWP MOSFET on-resistance	$V_{IN} = 3.7\text{ V}$, $I_{sw} = 200\text{ mA}$		300		m Ω
	SWP MOSFET rectifier on-resistance	$V_{IN} = 3.7\text{ V}$, $I_{sw} = 200\text{ mA}$		350		
I_{leak}	Leakage current into OUTP	CTRL = GND, $V_{OUTP} = 4.6V$; TPS65137A		17	25	μA
I_{SWP}	SWP switch current limit	$V_{IN} = 2.9\text{ V}$	0.9	1.1		A
V_{drop}	LDO Dropout voltage	$I_{out} = 100\text{ mA}$		300		mV
	Line regulation			0		%/V
	Load regulation			0.001		%/mA
OUTPUT OUTN						
V_{NEG}	Negative output voltage range		-2.2		-5.2	V
V_{NEG}	Negative output voltage regulation	$V_{IN} = 2.3V$ to $5.5V$, $I_{load} = 0mA$ to $150mA$; Valid for all voltage steps	-100		+100	mV
$R_{DS(ON)}$	SWN MOSFET on-resistance	$V_{IN} = 3.7\text{ V}$, $I_{sw} = 200\text{ mA}$		400		m Ω
	SWN MOSFET rectifier on-resistance	$V_{IN} = 3.7\text{ V}$, $I_{sw} = 200\text{ mA}$		550		
I_{LKG}	Leakage current out of OUTN	CTRL = GND, $V_{OUTN} = -5.2V$; TPS65137A		19	30	μA
I_{SWN}	SWN switch current limit	$V_{IN} = 2.9\text{ V}$	1.1	1.35		A
	Line regulation			0		%/V
	Load regulation			0.001		%/mA
CTRL INTERFACE						
V_H	Logic high-level voltage		1.2			V
V_L	Logic low-level voltage				0.4	V
R	Pull down resistor		150	200	860	k Ω
t_{init}	Initialization time			300	400	μs
t_{ss}	Softstart time			1		ms
t_{off}	Shutdown time period		30		80	μs
t_{high}	Pulse high level time period		2	10	25	μs
t_{low}	Pulse low level time period		2	10	25	μs
t_{store}	Data storage/accept time period		30		80	μs
t_{set}	OUTN transition time	$C_T = 100\text{ nF}$		20		ms
R_T	CT pin output impedance		150	250	500	k Ω

DEVICE INFORMATION

**10 PIN TQFN PACKAGE
(TOP VIEW)**

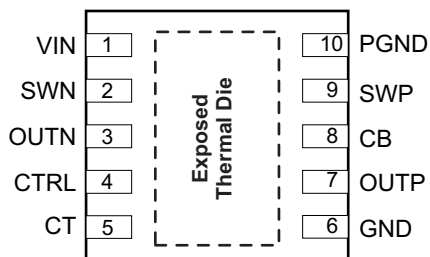

Pin Functions

PIN			DESCRIPTION
NAME	NO.	I/O	
VIN	1	I	Input supply
CT	5	O	Sets the settling time for the voltage on Vneg when programmed to a new value
CB	8	O	Internal boost converter bypass capacitor
GND	6		Analog ground
PGND	10		Power Ground
SWN	2		Switch pin of the negative buck boost converter
OUTN	3	O	Output of negative buck boost converter
OUTP	7	O	Output of the boost converter
CTRL	4	I	Combined enable and output voltage program pin
SWP	9		Switch pin of the boost converter
Exposed thermal die			Connect this pad to analog GND.

TYPICAL CHARACTERISTICS
TABLE OF GRAPHS

		FIGURE
Efficiency versus Output current		Figure 1
Efficiency versus Input voltage		Figure 2
Efficiency versus Negative voltage		Figure 3
Negative output voltage programming		Figure 4
Negative output voltage programming	Device enabled (CTRL = 400µs high), programmed to -3.0V	Figure 5
Light load current operation		Figure 6
Nominal load current operation	$V_{IN} = 3.7V$	Figure 7
Nominal load current operation	$V_{IN} = 4.5V$	Figure 8
Line transient response	150mA	Figure 9
Line transient response	100mA	Figure 10
Startup		Figure 11
Shutdown		Figure 12
Short circuit		Figure 13

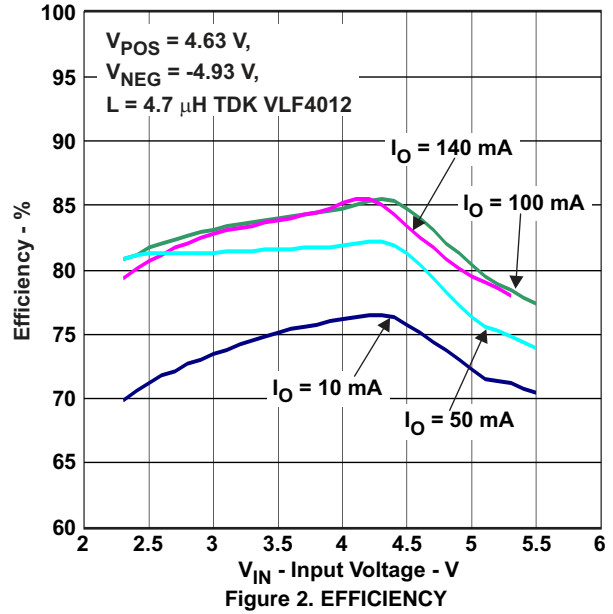
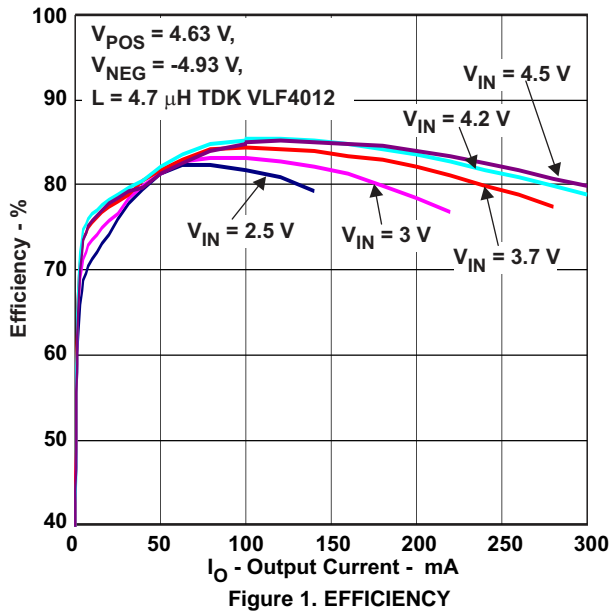

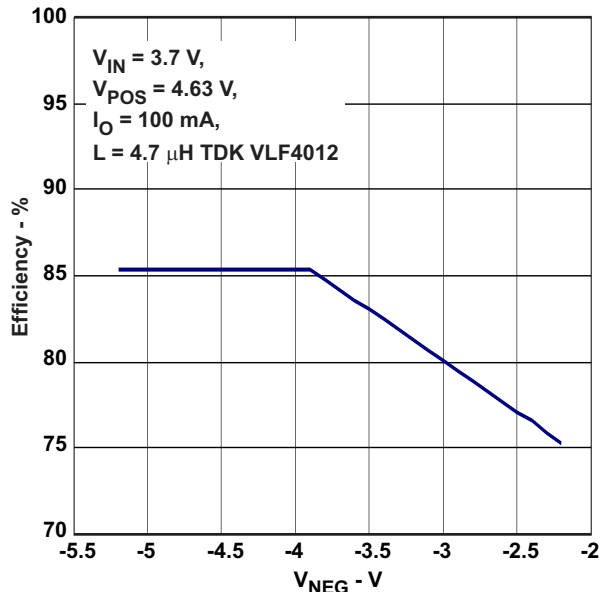

Figure 3. EFFICIENCY

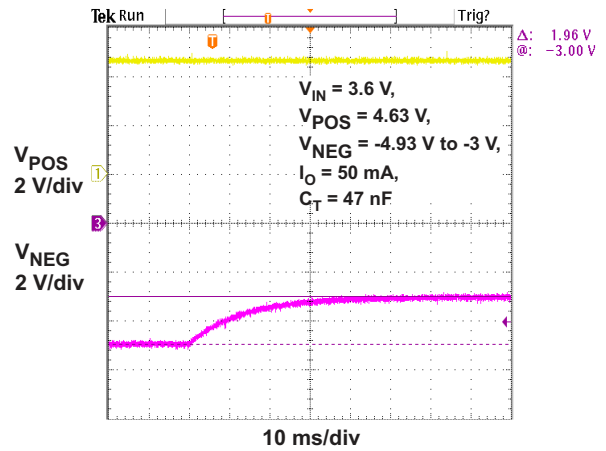

Figure 4. NEGATIVE OUTPUT VOLTAGE PROGRAMMING

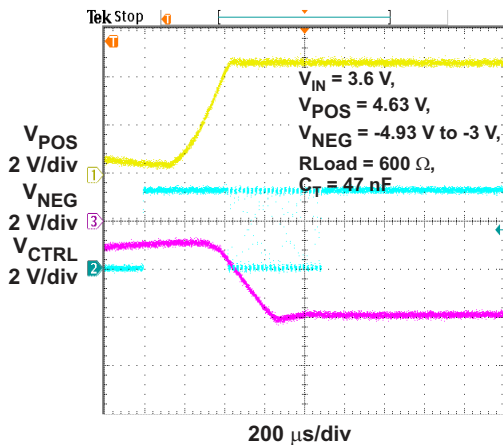

Figure 5. NEGATIVE OUTPUT VOLTAGE PROGRAMMING (Device enabled (CTRL = 400μs high), programmed to -3.0V)

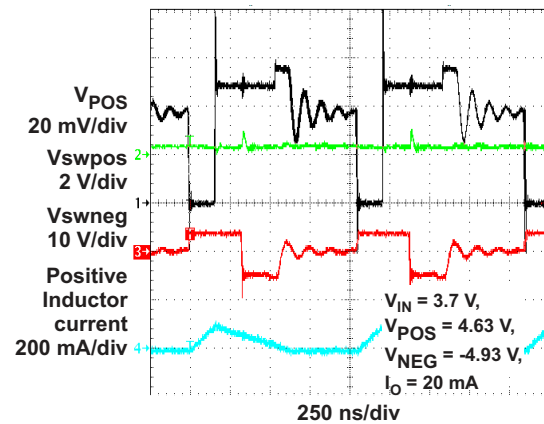

Figure 6. LIGHT LOAD CURRENT OPERATION

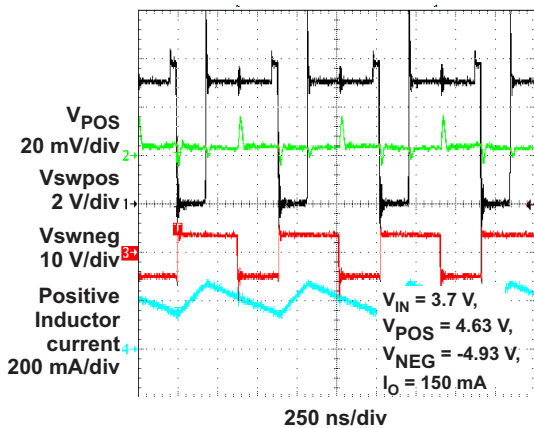

Figure 7. NOMINAL LOAD CURRENT OPERATION ($V_{IN} = 3.7\text{V}$)

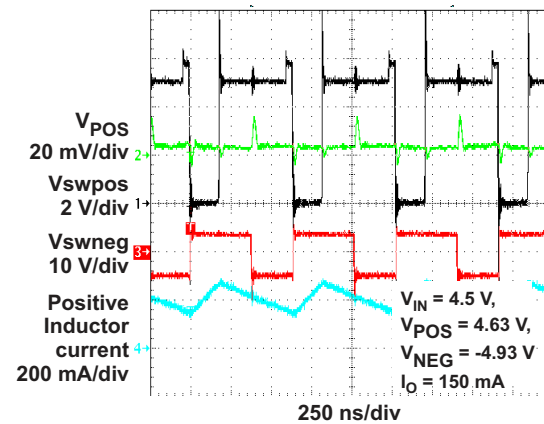

Figure 8. NOMINAL LOAD CURRENT OPERATION ($V_{IN} = 4.5\text{V}$)

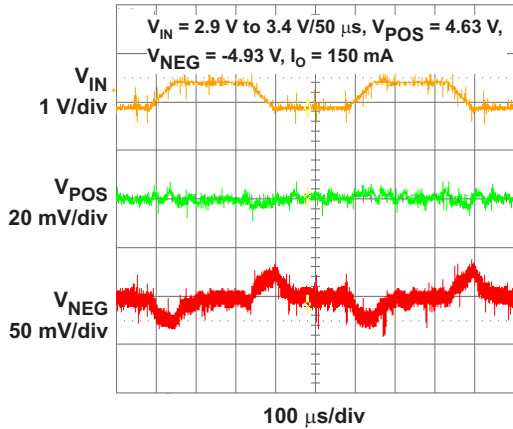

Figure 9. LINE TRANSIENT RESPONSE (150mA)

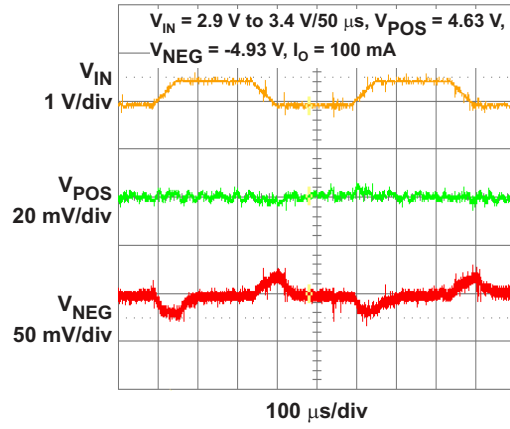

Figure 10. LINE TRANSIENT RESPONSE (100mA)

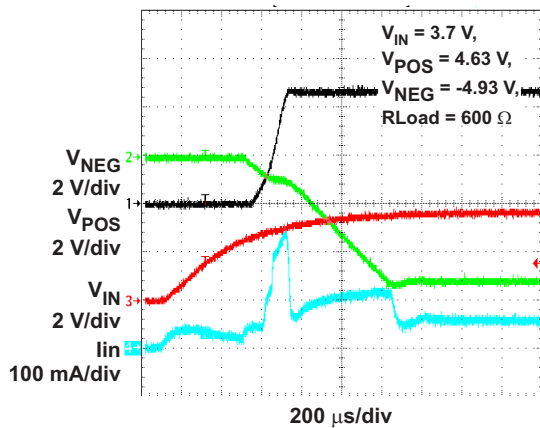

Figure 11. STARTUP

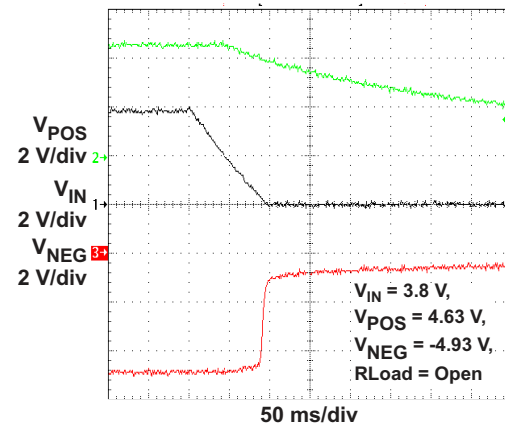

Figure 12. SHUTDOWN

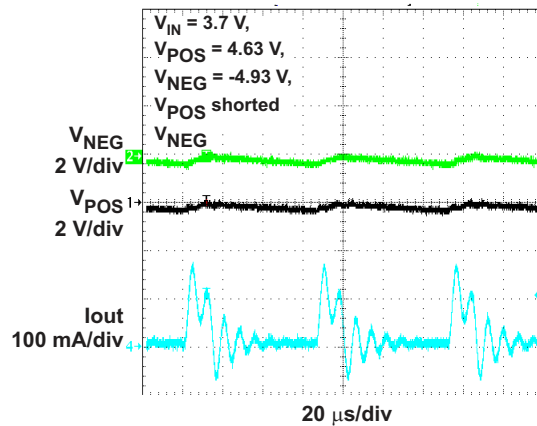
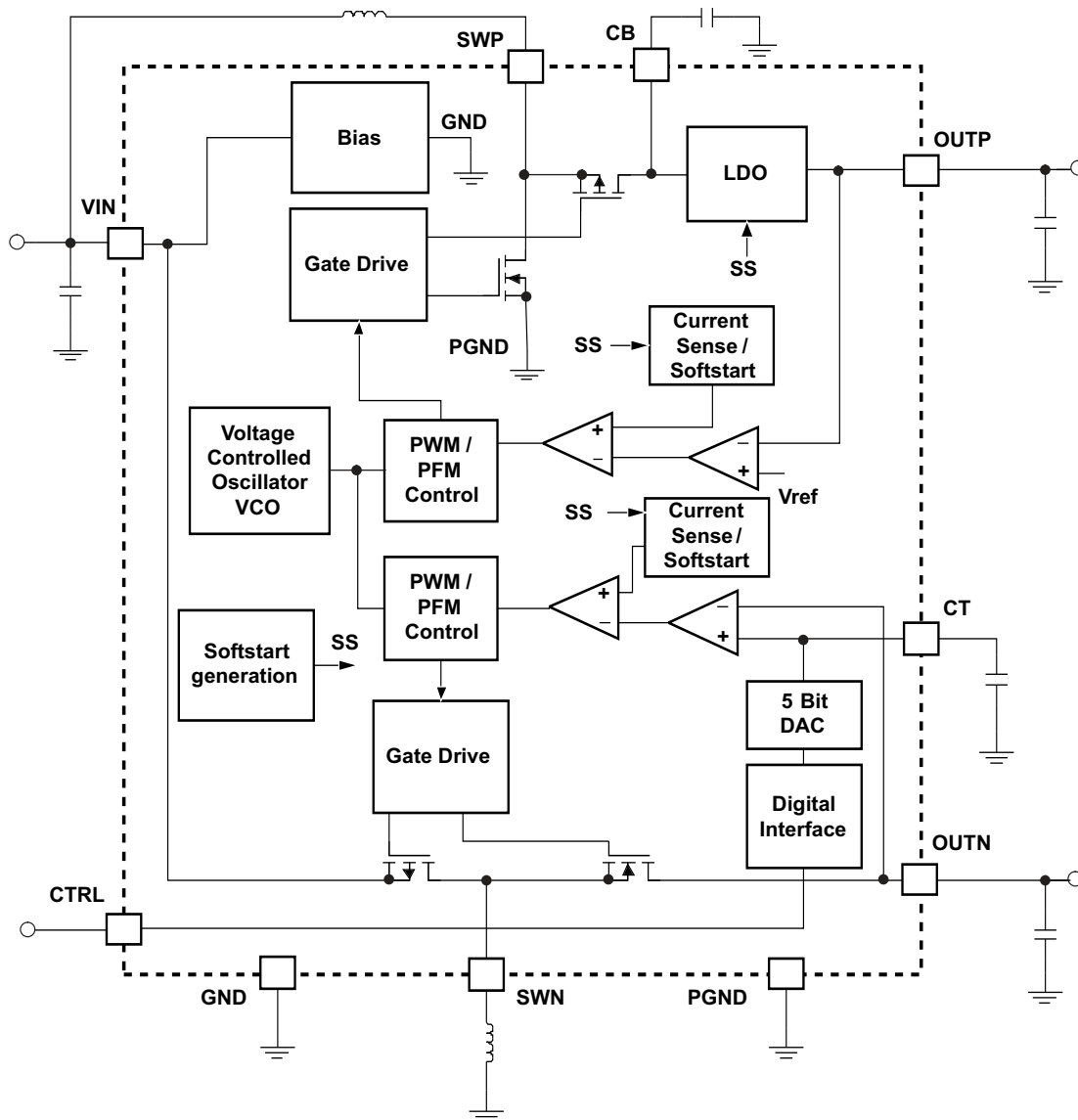

Figure 13. SHORT CIRCUIT

FUNCTIONAL BLOCK DIAGRAM



DETAILED DESCRIPTION

The TPS65137 consists of a boost converter using a LDO as post regulator. The output voltage of the boost converter is regulated to operate the internal LDO above its dropout voltage maintaining best line and load regulation of OOTP. The internal LDO disconnects OOTP during shutdown and allows regulation of the output when the input voltage is higher than OOTP. The LDO minimizes the output voltage ripple of OOTP. The negative output uses a buck boost converter topology operating in DCM (Discontinuous Conduction Mode) providing superior line regulation. In order to adjust the output voltage of the negative converter a digital interface can be used to program the output voltage. To achieve high efficiency over the entire load current range the device reduces the switching frequency with the load current using its internal voltage controlled oscillator (VCO). Since the boost converter output CB is post regulated by the integrated LDO (Low Dropout Regulator) the output voltage ripple is minimized and the line transient response is at its best. Because of this topology the operation mode of the boost converter has minimum effect on the output voltage ripple observed on OOTP. The boost converter, as well as the negative converter operate in peak current mode using the VCO (Voltage Controlled Oscillator) while operating in DCM (Discontinuous Conduction Mode). When entering CCM (Continuous Conduction Mode) the converter operates in peak current control using fixed off time control.

POWER SAVE MODE OPERATION

In order to maintain high efficiency over the entire load current range the converter reduces its switching frequency as the load current decreases. To maintain a controlled switching frequency a voltage controlled oscillator (VCO) is used.

SOFT START AND SHORT CIRCUIT PROTECTION

The device has a soft-start implemented limiting inrush current during turn on. The device is also protected against short circuits of the outputs to ground or when the outputs shorted together. This is implemented with two output voltage thresholds determining the device switch current limit and LDO operation shown in [Figure 14](#).

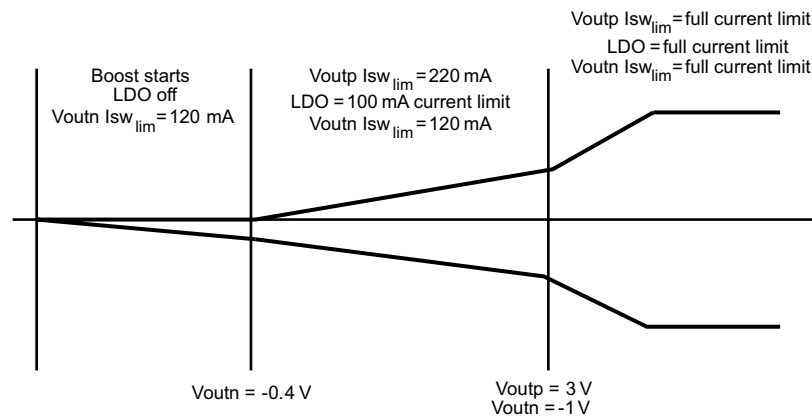

Figure 14. Soft Start and Short Circuit Thresholds

When the device is enabled pulling CTRL pin high then the boost converter and buck converter starts with reduced switch current limit. During this period of time the LDO is turned off. As V_{NEG} reaches $-0.4V$ then the LDO is turned on having a 100mA current limit. The switch current limit of both outputs is increased to 220mA and 120mA. When V_{POS} reaches 3V and V_{NEG} reaches $-1V$, then both outputs operate with full current limit. This architecture limits the inrush current during start-up and protects the device during short circuits events. When the positive output is shorted to the negative output then the device cycles between the first and second section of the start-up sequence. By that, the output current cycles between zero and 100mA. This protects the device and avoids excessive power dissipation during short circuit conditions. With this architecture the device is able to start-into full load current once V_{POS} exceeds 3V and V_{NEG} is lower than $-1V$.

ENABLE (CTRL pin)

The CTRL pin serves two functions. One is the enable and disable of the device, the other is the output voltage programming of the device. If the digital interface is not required the CTRL pin can be used as a standard enable pin for the device. Pulling CTRL high starts the converter operating with its default output voltage on OUTN of -4.93V .

DIGITAL INTERFACE (CTRL)

The digital interface allows programming the negative output voltage OUTN in digital steps. If the digital output voltage setting is not required then the CTRL pin can also be used as a standard enable pin. In such a case the device will come up with its default output voltage of OUTN of -4.93V .

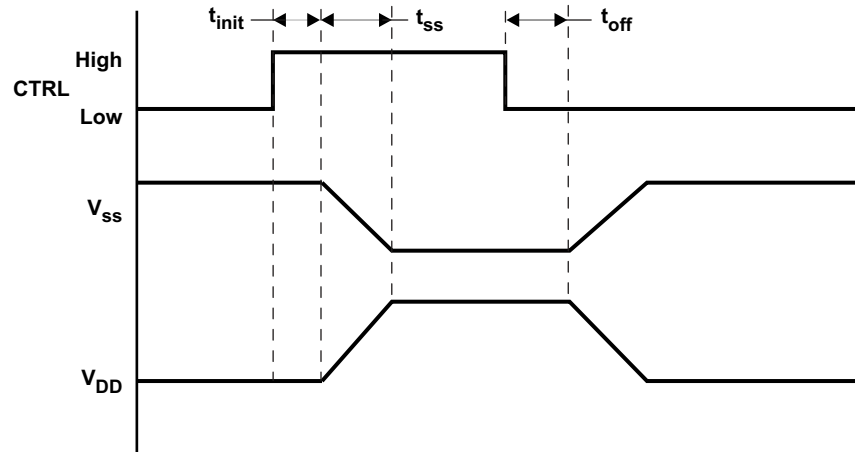

Figure 15. CTRL Used as a Standard Device Enable

The digital output voltage programming of OUTN is implemented by a simple digital interface with the timing shown in Figure 16.

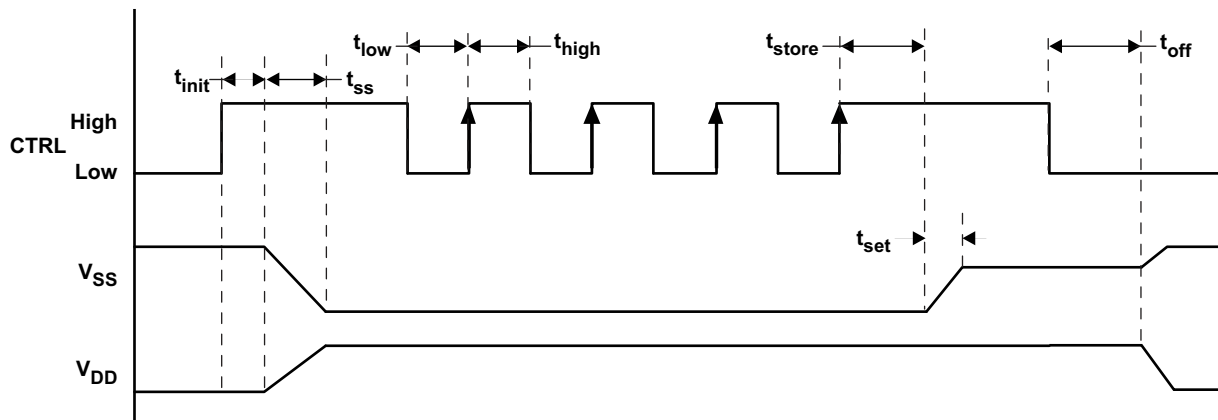

Figure 16. Digital Interface Using CTRL

Once CTRL is pulled high the device will come up with its default voltage of -4.93V . The TPS65137 has a 5 bit DAC implemented with the correspondent output voltage as given in Table 1. The interface counts the rising edges applied to CTRL pin once the device is enable. For example with the timing diagram shown in Figure 16, OUTN is programmed to -4.93V since 4 rising edges are applied. Other output voltages are programmed according to Table 1.

Table 1. Programming Table for OUTN

BIT/RISING EDGES	OUTN (V _{ss})	DAC VALUE	BIT/RISING EDGES	OUTN(V _{ss})	DAC VALUE
Default	-4.93 V	00000	16	-3.7 V	10000
1	-5.23 V	00001	17	-3.62 V	10001
2	-5.13 V	00010	18	-3.52 V	10010
3	-5.03 V	00011	19	-3.42 V	10011
4	-4.93 V	00100	20	-3.32 V	10100
5	-4.83 V	00101	21	-3.22 V	10101
6	-4.73 V	00110	22	-3.12 V	10110
7	-4.63 V	00111	23	-3.02 V	10111
8	-4.53 V	01000	24	-2.92 V	11000
9	-4.43 V	01001	25	-2.82 V	11001
10	-4.33 V	01010	26	-2.72 V	11010
11	-4.23 V	01011	27	-2.62 V	11011
12	-4.13 V	01100	28	-2.52 V	11100
13	-4.03 V	01101	29	-2.42 V	11101
14	-3.93 V	01110	30	-2.31 V	11110
15	-3.82 V	01111	31	-2.21 V	11111

V_{neg} Programming Transition Time t_{set} for OUTN (C_T)

The TPS65137 allows setting the transition time t_{set} using an external capacitor connected to pin CT. The transition time is the time period required to move OUTN from one voltage level to the next programmed voltage level. When the CT pin is left open then the shortest possible transition time is programmed. When connecting a capacitor to the CT pin then the transition time is given by the R-C time constant. This is given by the output impedance of the CT pin of typically 250kΩ and the external capacitance. Within one τ the output voltage OUTN has reached 70% of its programmed value. An example is given when using 100nF for C_T.

$$\tau \approx t_{\text{set}70\%} = 250 \text{ k}\Omega \times C_T = 250 \text{ k}\Omega \times 100 \text{ nF} = 25 \text{ mS}$$

INPUT CAPACITOR SELECTION

The device typically requires a 4.7μF ceramic input capacitor. Larger values can be used to lower the input voltage ripple.

Table 2. Input Capacitor Selection

CAPACITOR	COMPONENT SUPPLIER	SIZE
4.7 μF/10 V	Taiyo Yuden LMK107BJ475	0603
10 μF/10 V	Taiyo Yuden LMK212BJ106	0805
10 μF/6.3 V	Taiyo Yuden JMK107BJ106	0603

BOOST CONVERTER DESIGN CONSIDERATION, V_{pos}

The positive output consists of a boost converter using a LDO as post regulator. The maximum output current is limited by the minimum current limit of the LDO, of 200mA. The component values and output current are calculated at maximum load current in continuous conduction operation. The typical switching frequency during this operation mode is 1.4MHz.

The boost converter duty cycle is:

$$D = 1 - \frac{V_{\text{IN}} \times \eta}{V_{\text{POS}}} \quad (1)$$

To calculate the duty cycle, a good estimation for the efficiency, η, is 75% or it can be taken out of the typical curve in **Figure 1**. In order to calculate the maximum output current of the boost converter for a certain input voltage, the following formula is used:

$$I_{out} = (1 - D) \left(I_{sw} - \frac{V_{IN} \times D}{2 \times f_s \times L} \right) \quad (2)$$

The maximum output current is given at the highest switching frequency of typically 1.4MHz and minimum switch current limit of 0.9A. Equation 3 is used to calculate the switch peak current.

$$I_{swpeak} = \frac{V_{IN} \times D}{2 \times f_s \times L} + \frac{I_{out}}{1 - D} \quad (3)$$

The inductor needs to be rated for this switch peak current to avoid inductor saturation.

The boost converter output capacitor is connected to pin CB and a 4.7µF capacitor is sufficient. A 2.2µF capacitor is used on the output V_{POS} , which is the output of the internal low dropout regulator (LDO).

Table 3. Output Capacitor Selection

CAPACITOR	COMPONENT SUPPLIER	SIZE
4.7 µF/10 V	Taiyo Yuden LMK107BJ475	0603
2.2 µF/10 V	Taiyo Yuden LMK107BJ225	0603

NEGATIVE BUCK BOOST CONVERTER DESIGN CONSIDERATION, V_{neg}

The negative output is generated with a buck boost converter. The component values and output current are calculated at maximum load current in continuous conduction operation. The typical switching frequency during this operation mode is 1.4MHz.

The buck boost converter duty cycle is:

$$D = \frac{|V_{NEG}|}{V_{IN} \times \eta + |V_{NEG}|} \quad (4)$$

To calculate the duty cycle a good estimation for the efficiency, η , is 75% or it can be taken out of the typical curve in Figure 1. In order to calculate the maximum output current of the buck boost converter for a certain input voltage, the following formula is used:

$$I_{out} = (1 - D) \left(I_{sw} - \frac{V_{IN} \times D}{2 \times f_s \times L} \right) \quad (5)$$

The maximum output current is given at the highest switching frequency of typically 1.4MHz and minimum switch current limit of 1.1A. Equation 6 is used to calculate the switch peak current.

$$I_{swpeak} = \frac{V_{IN} \times D}{2 \times f_s \times L} + \frac{I_{out}}{1 - D} \quad (6)$$

The inductor needs to be rated for this switch peak current to avoid inductor saturation. Refer to Table 4 for possible inductors for this application. A 4.7µF output capacitor is used on the output V_{NEG} . Larger capacitor values can be used to minimize the output voltage ripple. Refer to Table 3 for output capacitor selection.

INDUCTOR SELECTION

The device is optimized to operate with 4.7uH inductors. Different inductor values will change the converter efficiency and output voltage ripple. A 2.2uH inductor is also a possible solution. Any other inductor values will degrade device performance and stability which is not recommended for this device.

Table 4. Inductor Selection

INDUCTOR VALUE	COMPONENT SUPPLIER	DIMENSIONS in mm	I _{sat} /DCR
4.7 µH	TDK VLF4012	3.7 × 3.5 × 1.2	1.1A/140mΩ

APPLICATION INFORMATION

PCB LAYOUT

The layout for this device is important to keep the output voltage ripple and output voltage accuracy as low and accurate as possible. The following layout guidelines apply for this device:

- Keep the switch node pad for the boost converter and inverter switch as small as possible to avoid coupling into the output.
- The ground connection for the inductor of the negative converter needs to be as wide as possible to avoid noise generated by inductor ground currents.
- The ground connection of the timing capacitor on pin CT needs to be isolated and directly routed to the GND pin of the device. This is important to avoid noise being coupled into the error amplifier which is internally connected to the CT pin.
- Having the ground connection of the boost converter output capacitor and LDO output capacitor in a close connection to the device ground and power pad connection achieves best load regulation.

REVISION HISTORY

Changes from Original (May 2010) to Revision A	Page
• Changed Features 6, 7 and 8 from 4.6V to 4.63V, -5.2V to -5.23V and -4.9V to -4.93V	1
• Changed TYPICAL APPLICATION V_{POS} from 4.6V/200mA to 4.63V/200mA	1
• Changed ELECTRICAL CHARACTERISTICS conditions from OUTP=4.6V to OUTP=4.63V and OUTN= -4.9V to -4.93V	4
• Changed ELECTRICAL CHARACTERISTICS OUTPUT OUTP V_{POS} , TYP column from 4.6 to 4.63	4
• Changed V_{POS} from 4.6V to 4.63V and V_{NEG} from -4.9V -4.93V in graphs	6
• Changed Figure 9 waveform	7
• Changed Figure 10 waveform	7
• Changed -4.9V. to -4.93V in Digital Interface (CTRL) section	11
• Changed values in Table 1	12

PACKAGING INFORMATION

Orderable Device	Status (1)	Package Type	Package Drawing	Pins	Package Qty	Eco Plan (2)	Lead finish/ Ball material (6)	MSL Peak Temp (3)	Op Temp (°C)	Device Marking (4/5)	Samples
TPS65137ADSCR	LIFEBUY	WSON	DSC	10	3000	RoHS & Green	NIPDAU	Level-2-260C-1 YEAR	-40 to 85	PTTI	

(1) The marketing status values are defined as follows:

ACTIVE: Product device recommended for new designs.

LIFEBUY: TI has announced that the device will be discontinued, and a lifetime-buy period is in effect.

NRND: Not recommended for new designs. Device is in production to support existing customers, but TI does not recommend using this part in a new design.

PREVIEW: Device has been announced but is not in production. Samples may or may not be available.

OBSOLETE: TI has discontinued the production of the device.

(2) **RoHS:** TI defines "RoHS" to mean semiconductor products that are compliant with the current EU RoHS requirements for all 10 RoHS substances, including the requirement that RoHS substance do not exceed 0.1% by weight in homogeneous materials. Where designed to be soldered at high temperatures, "RoHS" products are suitable for use in specified lead-free processes. TI may reference these types of products as "Pb-Free".

RoHS Exempt: TI defines "RoHS Exempt" to mean products that contain lead but are compliant with EU RoHS pursuant to a specific EU RoHS exemption.

Green: TI defines "Green" to mean the content of Chlorine (Cl) and Bromine (Br) based flame retardants meet JS709B low halogen requirements of <=1000ppm threshold. Antimony trioxide based flame retardants must also meet the <=1000ppm threshold requirement.

(3) MSL, Peak Temp. - The Moisture Sensitivity Level rating according to the JEDEC industry standard classifications, and peak solder temperature.

(4) There may be additional marking, which relates to the logo, the lot trace code information, or the environmental category on the device.

(5) Multiple Device Markings will be inside parentheses. Only one Device Marking contained in parentheses and separated by a "-" will appear on a device. If a line is indented then it is a continuation of the previous line and the two combined represent the entire Device Marking for that device.

(6) Lead finish/Ball material - Orderable Devices may have multiple material finish options. Finish options are separated by a vertical ruled line. Lead finish/Ball material values may wrap to two lines if the finish value exceeds the maximum column width.

Important Information and Disclaimer:The information provided on this page represents TI's knowledge and belief as of the date that it is provided. TI bases its knowledge and belief on information provided by third parties, and makes no representation or warranty as to the accuracy of such information. Efforts are underway to better integrate information from third parties. TI has taken and continues to take reasonable steps to provide representative and accurate information but may not have conducted destructive testing or chemical analysis on incoming materials and chemicals. TI and TI suppliers consider certain information to be proprietary, and thus CAS numbers and other limited information may not be available for release.

In no event shall TI's liability arising out of such information exceed the total purchase price of the TI part(s) at issue in this document sold by TI to Customer on an annual basis.

TAPE AND REEL INFORMATION

QUADRANT ASSIGNMENTS FOR PIN 1 ORIENTATION IN TAPE

*All dimensions are nominal

Device	Package Type	Package Drawing	Pins	SPQ	Reel Diameter (mm)	Reel Width W1 (mm)	A0 (mm)	B0 (mm)	K0 (mm)	P1 (mm)	W (mm)	Pin1 Quadrant
TPS65137ADSCR	WSON	DSC	10	3000	330.0	12.4	3.3	3.3	1.1	8.0	12.0	Q2

TAPE AND REEL BOX DIMENSIONS

*All dimensions are nominal

Device	Package Type	Package Drawing	Pins	SPQ	Length (mm)	Width (mm)	Height (mm)
TPS65137ADSCR	WSON	DSC	10	3000	346.0	346.0	33.0

GENERIC PACKAGE VIEW

DSC 10

WSON - 0.8 mm max height

PLASTIC SMALL OUTLINE - NO LEAD

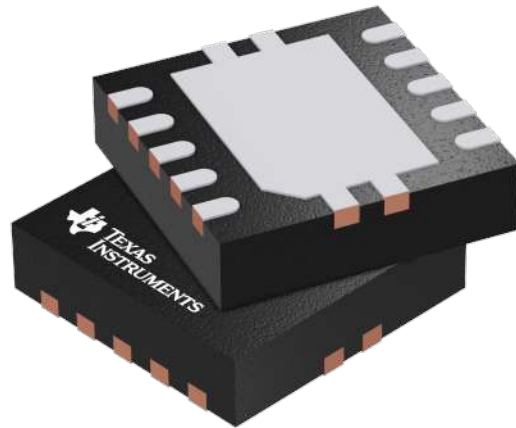

Images above are just a representation of the package family, actual package may vary.
Refer to the product data sheet for package details.

4207383/F

IMPORTANT NOTICE AND DISCLAIMER

TI PROVIDES TECHNICAL AND RELIABILITY DATA (INCLUDING DATA SHEETS), DESIGN RESOURCES (INCLUDING REFERENCE DESIGNS), APPLICATION OR OTHER DESIGN ADVICE, WEB TOOLS, SAFETY INFORMATION, AND OTHER RESOURCES "AS IS" AND WITH ALL FAULTS, AND DISCLAIMS ALL WARRANTIES, EXPRESS AND IMPLIED, INCLUDING WITHOUT LIMITATION ANY IMPLIED WARRANTIES OF MERCHANTABILITY, FITNESS FOR A PARTICULAR PURPOSE OR NON-INFRINGEMENT OF THIRD PARTY INTELLECTUAL PROPERTY RIGHTS.

These resources are intended for skilled developers designing with TI products. You are solely responsible for (1) selecting the appropriate TI products for your application, (2) designing, validating and testing your application, and (3) ensuring your application meets applicable standards, and any other safety, security, regulatory or other requirements.

These resources are subject to change without notice. TI grants you permission to use these resources only for development of an application that uses the TI products described in the resource. Other reproduction and display of these resources is prohibited. No license is granted to any other TI intellectual property right or to any third party intellectual property right. TI disclaims responsibility for, and you will fully indemnify TI and its representatives against, any claims, damages, costs, losses, and liabilities arising out of your use of these resources.

TI's products are provided subject to [TI's Terms of Sale](#) or other applicable terms available either on [ti.com](https://www.ti.com) or provided in conjunction with such TI products. TI's provision of these resources does not expand or otherwise alter TI's applicable warranties or warranty disclaimers for TI products.

TI objects to and rejects any additional or different terms you may have proposed.

Mailing Address: Texas Instruments, Post Office Box 655303, Dallas, Texas 75265
Copyright © 2023, Texas Instruments Incorporated