



GLF74139

Ultra-low Power, 4.5 A Power Mux Switch with True Reverse Current Blocking

Product Specification

DESCRIPTION

The GLF74139 is a fully integrated power path switch with the automatic and manual selection function. The GLF74139 offers an industry leading true reverse current blocking (TRCB) function to protect input sources when the VOUT increase higher than VIN abnormally.

The EN pin can be used along with the SEL pin to control two integrated main FETs of the GLF74139. By the combination of these two pins, one of input source selection modes is set to provide power to downstream system seamlessly.

The automatic selection mode chooses a higher input voltage source between two inputs. In the manual selection mode, one of input sources is connected to downstream system.

APPLICATIONS

- Smart Devices
- Subsystem with Backup Power
- IoT Tracking System

FEATURES

- Two-Input and Single-Output Power Multiplexer Switch
- Automatic and Manual Input Selection Modes
- True Reverse Current Blocking on Each Channel
- Supply Voltage Range: 2.0 V to 5.5 V
- $R_{ON} = 20 \text{ m}\Omega$ Typ at 5.5 V_{IN1} or V_{IN2}
- 4.5 A Continuous Output Current Capability Per Channel
- Ultra-Low Supply Current at Operation
I_Q: 4 μ A Typ at 5.5 V_{IN}
- Ultra-Low Stand-by Current
I_{SD}: 30 nA Typ at 5.5 V_{IN}
- Smart Control Pins
I_{EN} and I_{SEL} : 10 nA Typ at V_{EN} or V_{SEL} > V_{IH}
R_{EN} and R_{SEL} : 500 k Ω Typ
- HBM: 6 kV, CDM: 2 kV

PACKAGE

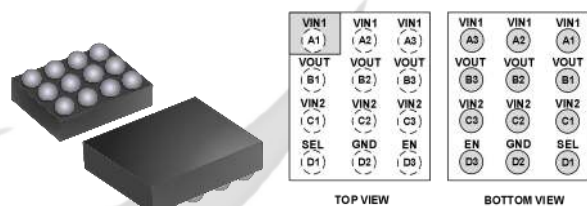

1.27 mm x 1.67 mm x 0.55 mm, WLCSP
0.4 mm pitch

DEVICE INFORMATION

Part Number	Top Mark	R_{ON} at 5.5 V _{IN}	Output Current, I _{OUT} Per Channel	Ultra-low I _Q at 5.5 V _{IN}
GLF74139	EJ	20 m Ω	4.5 A	4 μ A

APPLICATION DIAGRAM

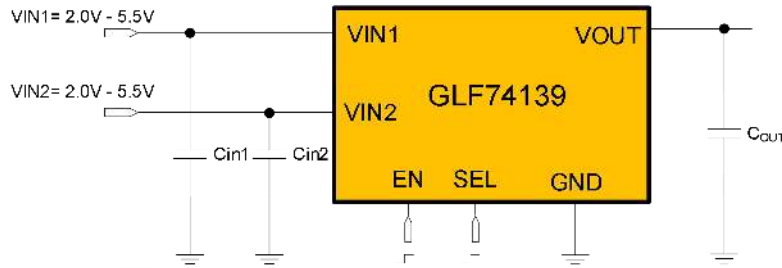

FUNCTIONAL BLOCK DIAGRAM

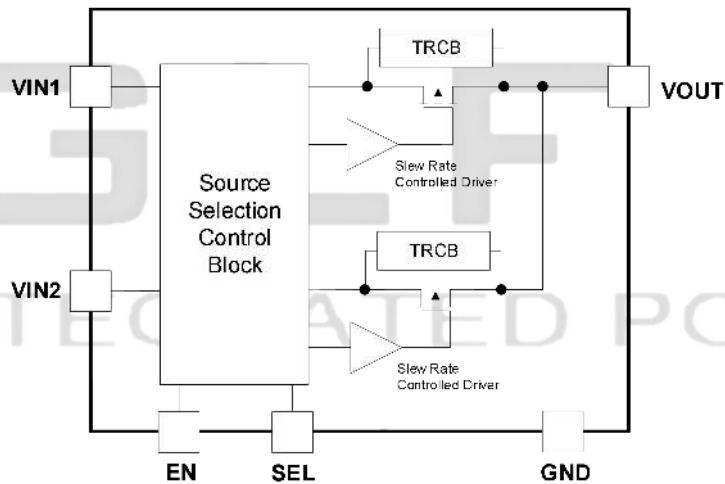
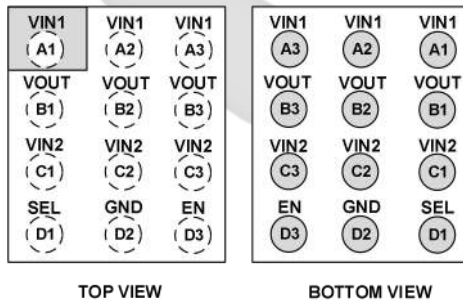

Figure 1. Functional Block Diagram

PIN CONFIGURATION

PIN DEFINITION



Pin #	Name	Description
A1, A2, A3	VIN1	Switch Input 1 Supply Voltage
B1, B2, B3	VOUT	Switch Output
C1, C2, C3	VIN2	Switch Input 2 Supply Voltage
D1	SEL	Input Source Selection. Do not leave the SEL pin floating.
D2	GND	Ground
D3	EN	Enable to control the switch.

Figure 2. 1.27mm x 1.67mm x 0.55mm WLCSP

ABSOLUTE MAXIMUM RATINGS

Stresses exceeding the absolute maximum ratings may damage the device. The device may not function or be operable above the recommended operating conditions; extended exposure to stresses above the recommended operating conditions may affect device reliability. The absolute maximum ratings are stress ratings only.

Symbol	Parameter	Min.	Max.	Unit
VIN1, VIN2 VOUT, EN	Each Pin Voltage Range to GND	-0.3	6	V
I _{OUT}	Continuous Current		4.5	A
	Pulse, 100 us pulse and 2 % duty cycle		6.5	A
P _D	Power Dissipation at T _A = 25 °C		1.2	W
T _J	Maximum Junction Temperature		150	°C
T _{STG}	Storage Junction Temperature	-65	150	°C
T _A	Ambient Operating Temperature Range	-40	85	°C
θ _{JA}	Thermal Resistance, Junction to Ambient		85	°C/W
ESD	Electrostatic Discharge Capability	Human Body Model, JESD22-A114	6	kV
		Charged Device Model, JESD22-C101	2	

RECOMMENDED OPERATING CONDITIONS

Symbol	Parameter	Min.	Max.	Unit
VIN1, VIN2	Supply Voltage	2.0	5.5	V
T _A	Ambient Operating Temperature Range	-40	+85	°C

ELECTRICAL CHARACTERISTICS

$V_{IN1} = V_{IN2} = 2.0\text{ V}$ to 5.5 V and $T_A = 25\text{ °C}$. Unless otherwise noted

Symbol	Parameter	Conditions	Min	Typ	Max	Units
Basic Operation						
I_{Q1}, I_{Q2}	Quiescent Current	$V_{IN1} = 5.5\text{ V}, V_{IN2} < V_{in1}, I_{OUT} = 0\text{ mA},$ $EN = 0\text{ V}, SEL = V_{IN1}, V_{OUT} = V_{IN1}$ or $V_{IN2} = 5.5\text{ V}, V_{IN1} < V_{IN2}, I_{OUT} = 0\text{ mA},$ $EN = SEL = V_{IN2}, V_{OUT} = V_{IN2}$		4	6	μA
		As above, $T_a = 85\text{ °C}^{(1)}$		4.7		
I_{SD1}, I_{SD2}	Shutdown Current	$V_{IN1,2} = 5.5\text{ V}, V_{OUT} = \text{GND}, EN = SEL = 0\text{ V}$		30	200	nA
		$V_{IN1,2} = 5.5\text{ V}, V_{OUT} = \text{GND}, EN = SEL = 0\text{ V}$ $T_a = 85\text{ °C}^{(1)}$		290		
R_{ON}	On-Resistance	V_{IN1} or $V_{IN2} = 5.5\text{ V}, I_{OUT} = 500\text{ mA}$	$T_a = 25\text{ °C}$	20	26	m Ω
			$T_a = 85\text{ °C}^{(1)}$	25		
		V_{IN1} or $V_{IN2} = 4.5\text{ V}, I_{OUT} = 500\text{ mA}$	$T_a = 25\text{ °C}$	23		
			$T_a = 85\text{ °C}^{(1)}$	26		
		V_{IN1} or $V_{IN2} = 3.3\text{ V}, I_{OUT} = 500\text{ mA}$	$T_a = 25\text{ °C}$	27	33	
			$T_a = 85\text{ °C}^{(1)}$	32		
V_{IN1} or $V_{IN2} = 2.5\text{ V}, I_{OUT} = 300\text{ mA}$	$T_a = 25\text{ °C}$	34				
	$T_a = 25\text{ °C}$	43				
V_{IH}	EN and SEL Input Logic High Voltage	V_{IN1} or $V_{IN2} = 2.0\text{ V}$ to 5.5 V	1.2			V
V_{IL}	EN and SEL Input Logic Low Voltage	V_{IN1} or $V_{IN2} = 2.0\text{ V}$ to 5.5 V			0.45	V
I_{EN}, I_{SEL}	EN, SEL Current	EN or SEL Voltage $> V_{IH}$, Enabled		10		nA
R_{EN}, R_{SEL}	EN and SEL pull down resistance	EN or SEL Voltage $< V_{IH}$, Disabled		500		k Ω
V_{RCB_TH}	TRCB Protection Threshold	$V_{OUT} - V_{IN}$		35		mV
V_{RCB_RL}	TRCB Protection Release	$V_{IN} - V_{OUT}$		20		
I_{RVS}	Reverse Current ⁽¹⁾	$V_{IN1} = V_{IN2} = 0\text{ V}, V_{OUT} = 5.5\text{ V}, EN = SEL = 0\text{ V},$ Current on the input node from V_{OUT} to V_{IN}		70		nA
Switching Characteristics ⁽²⁾						
t_{dON}	Turn-On Delay	$V_{IN1} = 5.0\text{ V}, V_{IN2} = 3.3\text{ V}$ $R_L = 150\text{ }\Omega, C_{OUT} = 10\text{ }\mu\text{F}$		740		μs
t_R	VOUT Rise Time			1		ms
TdHL	High-low Delay ⁽¹⁾			15		μs
TfHL	High-low Fall Time ⁽¹⁾			240		μs
Vdroop	Voltage Droop ⁽¹⁾			100		mV
TdLH	Low-high Delay ⁽¹⁾			10		μs
TrLH	Low-high Rise Time ⁽¹⁾			9		μs
tdOFF	Turn-Off Delay ⁽¹⁾			80		μs
t_F	VOUT Fall Time ⁽¹⁾			3		ms

- Notes:**
1. By design; characterized, not production tested.
 2. $t_{ON} = t_{dON} + t_R$, $t_{OFF} = t_{dOFF} + t_F$

TIMING DIAGRAM AND TRUTH TABLE

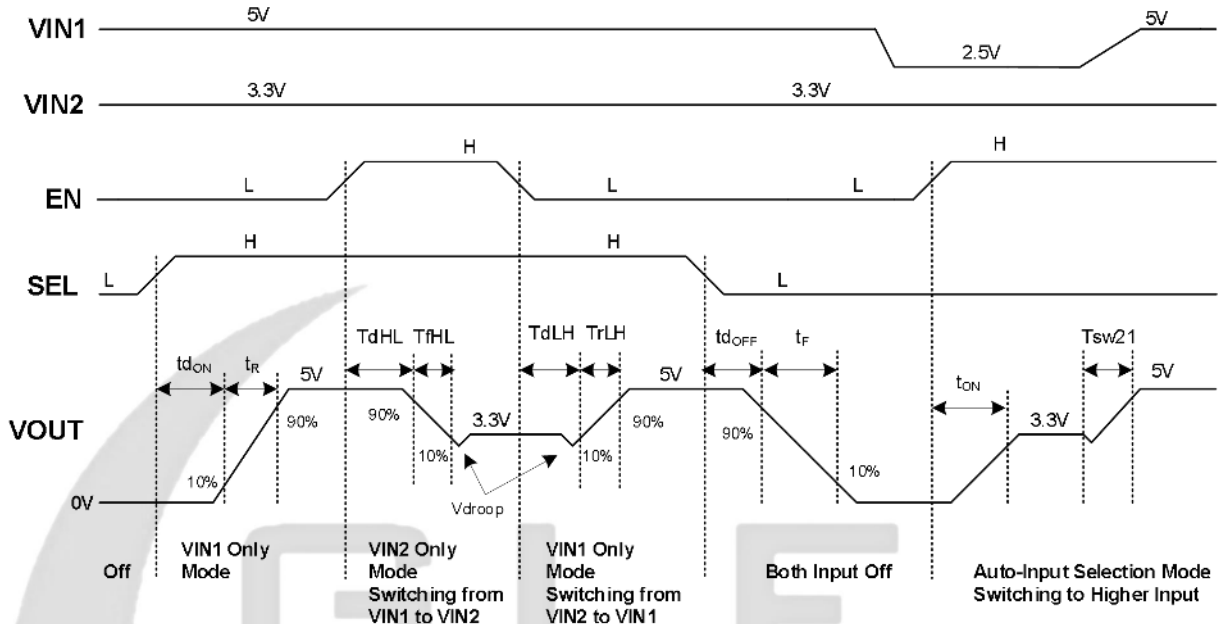

Figure 3. Timing Diagram

SEL	EN	Function	VOUT
0	0	Both switches are off.	High-Z
0	1	Auto-Input selection. Vout is connected to a higher input source automatically.	Higher Input between VIN1 and VIN2
1	0	Only VIN1 is selected.	VIN1
1	1	Only VIN2 is selected.	VIN2

Table 1. Truth Table of Input Source Selection

TYPICAL PERFORMANCE CHARACTERISTICS

Both VIN1 and VIN2 switches are identical.

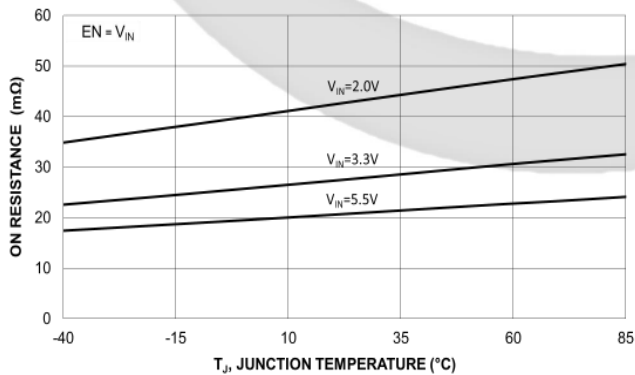

Figure 4. On-Resistance vs. Temperature

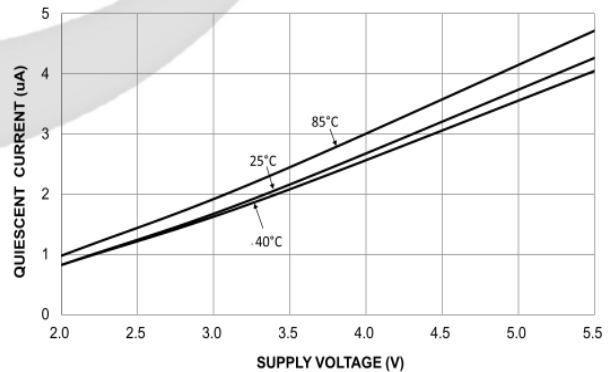

Figure 5. Quiescent Current vs. Supply Voltage

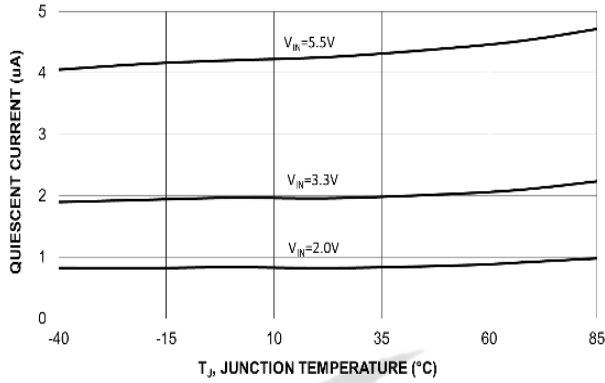

Figure 6. Quiescent Current vs. Temperature

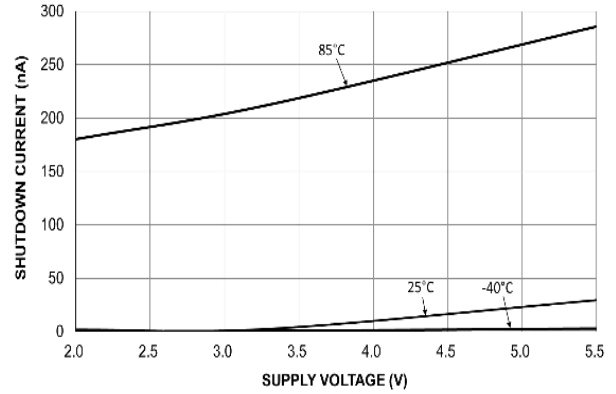

Figure 7. Shutdown Current vs. Supply Voltage

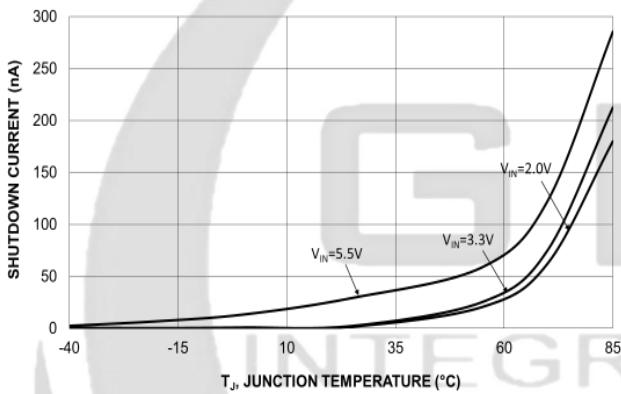

Figure 8. Shutdown Current vs. Temperature

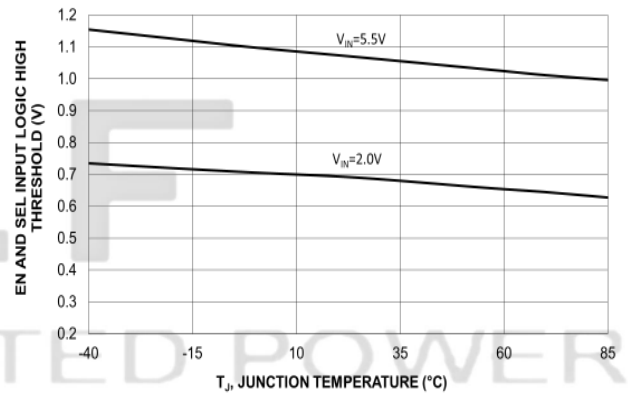

Figure 9. EN and SEL Input Logic High Threshold Vs. Temperature

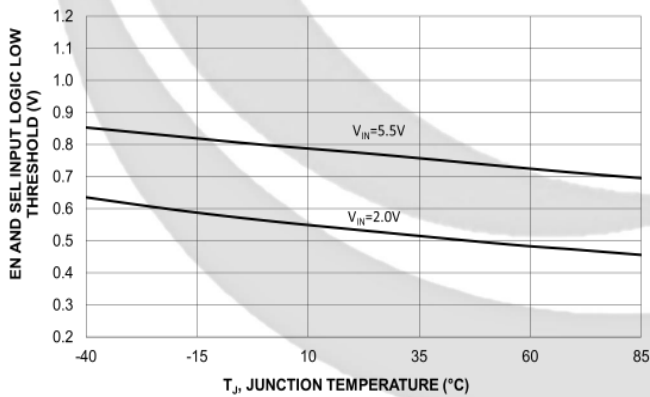

Figure 10. EN and SEL Input Logic Low Threshold vs. Temperature

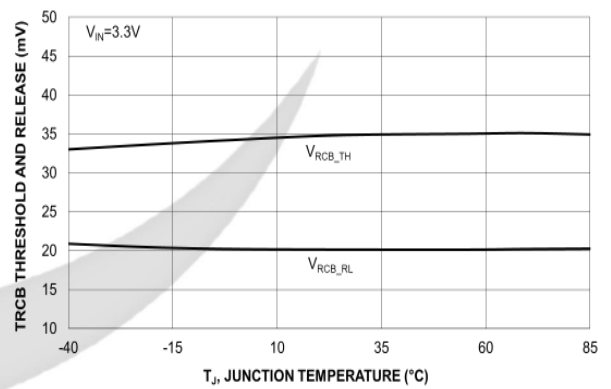

Figure 11. True Reverse Current vs. Temperature

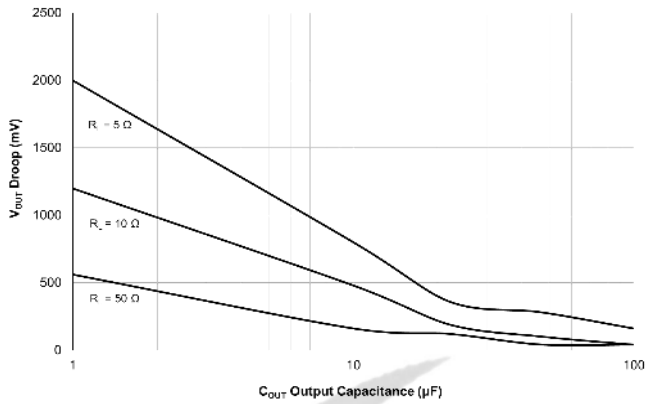

Figure 12. Output Voltage Droop at Switching Over from V_{IN1} (5 V) to V_{IN2} (3 V)

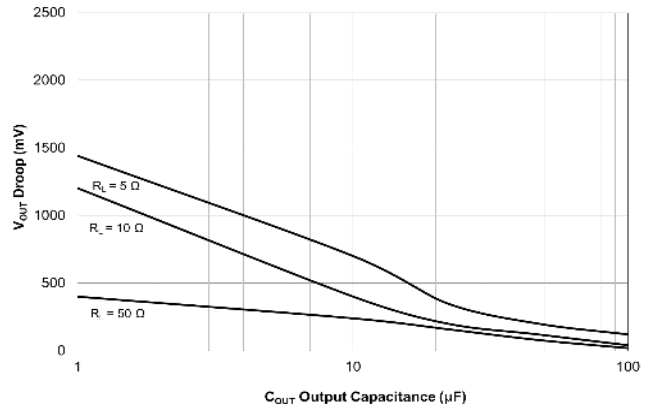

Figure 13. Output Voltage Droop at Switching Over from V_{IN2} (3 V) to V_{IN1} (5 V)

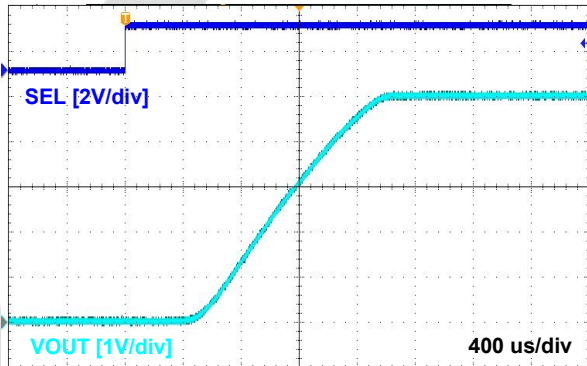

Figure 14. Turn-On Response

$V_{IN1}=5.0$ V, $C_{IN}=10$ μ F, $C_{OUT}=10$ μ F, $R_L=150$ Ω , $EN=Low$

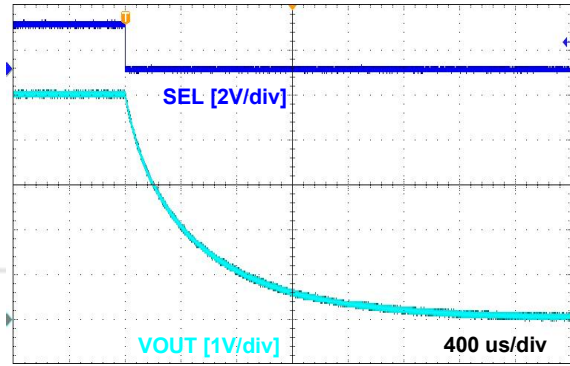

Figure 15. Turn-Off Response

$V_{IN1}=5.0$ V, $C_{IN}=10$ μ F, $C_{OUT}=10$ μ F, $R_L=150$ Ω . $EN=Low$

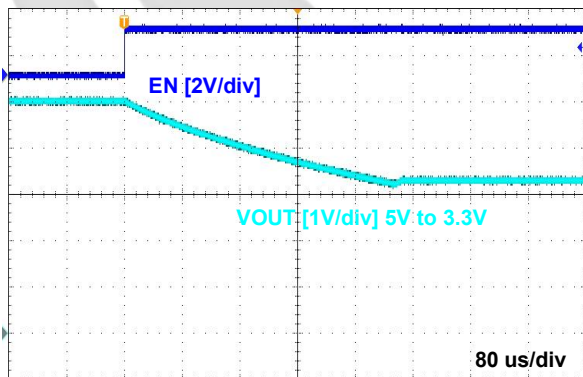

Figure 16. V_{OUT} Switchover from 5 V_{IN} to 3.3 V_{IN}

$V_{IN1}=5.0$ V, $V_{IN2}=3.3$ V $C_{IN}=10$ μ F, $C_{OUT}=10$ μ F, $R_L=150$ Ω

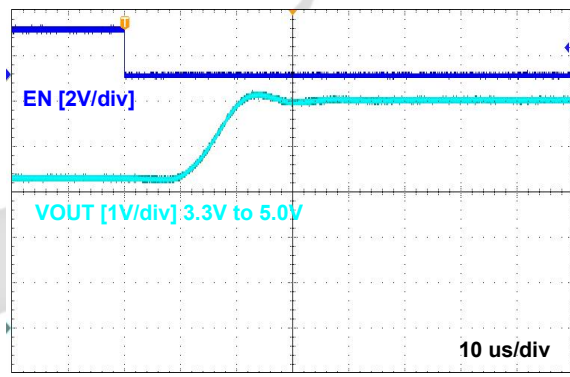

Figure 17. V_{OUT} Switchover 3.3 V_{IN} to 5 V_{IN}

$V_{IN1}=5.0$ V, $V_{IN2}=3.3$ V $C_{IN}=10$ μ F, $C_{OUT}=10$ μ F, $R_L=150$ Ω

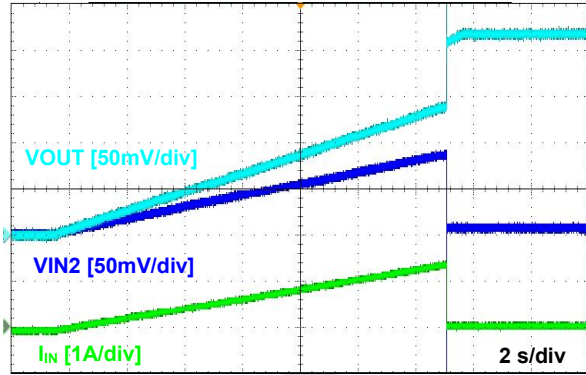

Figure 18. True Reverse Current Blocking on Each VIN
VIN1 or VIN2=3.3 V, VOUT= From 3 V to 3.4 V, CIN=COUT=10 μ F

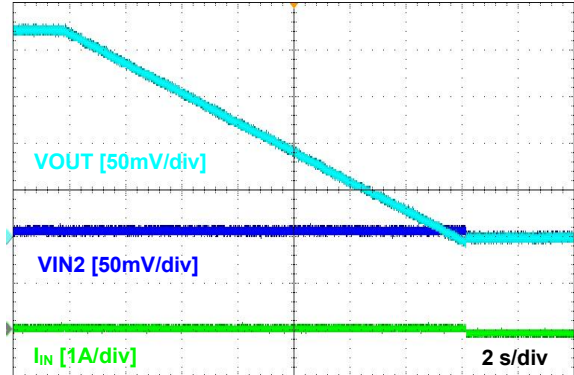

Figure 19. True Reverse Current Blocking Release
VIN1 or VIN2=3.3 V, VOUT= From 3 V to 3.4 V, CIN=COUT=10 μ F

APPLICATION INFORMATION

The GLF74139 is a fully integrated 4.5 A power mux with a fixed slew rate control to limit the inrush current during turn on in the input voltage range from 2.0 V to 5.5 V. Each device has very low on-resistance to reduce conduction loss. In the off state, these devices consume very low leakage current to avoid unwanted standby current and save limited input power supply. The package is 1.27 mm x 1.67 mm x 0.55 mm wafer level chip scale package saving space in compact applications and it has 12 bumps, 0.4 mm pitch for manufacturing availability.

Input Source Selection

According to the state of SEL and EN pins, the GLF74139 offers the automatic as well as the manual selection mode. In each mode, the VOUT connects to one input source. Do not leave both SEL and EN pins floating.

SEL	EN	Function	VOUT
0	0	Both switches are off.	High-Z
0	1	Auto-Input selection. VOUT is connected to a higher input source automatically.	Higher Input between VIN1 and VIN2
1	0	Only VIN1 is selected.	VIN1
1	1	Only VIN2 is selected.	VIN2

True Reverse Current Blocking

The GLF74139 has a built-in reverse current blocking protection which always monitors the output voltage level regardless of the status of EN pin to check if it is greater than the input voltage. When the output voltage goes beyond the input voltage by the TRCB protection threshold voltage, V_{RCB_TH} that is the reverse current blocking protection trip voltage, the reverse current blocking function block turns off the switch immediately. Note that some reverse current can occur until the V_{RCB_TH} is triggered. The main switch will get back to normal operation when the output voltage drops below the input source by the TRCB protection release voltage.

Smart EN and SEL Control Pin

With a control voltage less than the V_{IH} for EN or SEL pin, the internal pull-down resistance (R_{EN} or R_{SEL} = 500 k Ω Typ.) is used to keep control pins from floating and ensure a reliable off state. When a voltage higher than the V_{IH} is applied to EN and SEL pin, the 500 k Ω pull-down resistor will be completely disconnected save unnecessary power consumption and enable the pin function.

Input Capacitor

A capacitor is recommended to be placed close to the V_{IN} pin to reduce the voltage drop on the input power rail caused by transient inrush current at start-up. The low ESR capacitor is preferred to avoid output oscillation during the switching-over period in the auto-input selection mode when the output current is high. A higher input capacitor value can be used to further attenuate the input voltage drop

Output Capacitor

An output capacitor is recommended to mitigate voltage undershoot on the output pin the moment when the switch is turned off. Undershoot can be caused by parasitic inductance from board traces or intentional load inductances. If load inductances do exist, use of an output capacitor can improve output voltage stability and system reliability. The C_{OUT} capacitor should be placed close to the V_{OUT} and GND pins.

Board Layout

All traces should be as short as possible to minimize parasitic inductance effect. Wide traces for V_{IN} , V_{OUT} , and GND will help reduce signal degradation and parasitic effects during dynamic operations as well as improve the thermal performance at high load current.

GLF
INTEGRATED POWER

PACKAGE OUTLINE

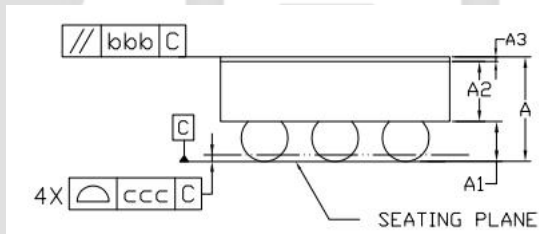
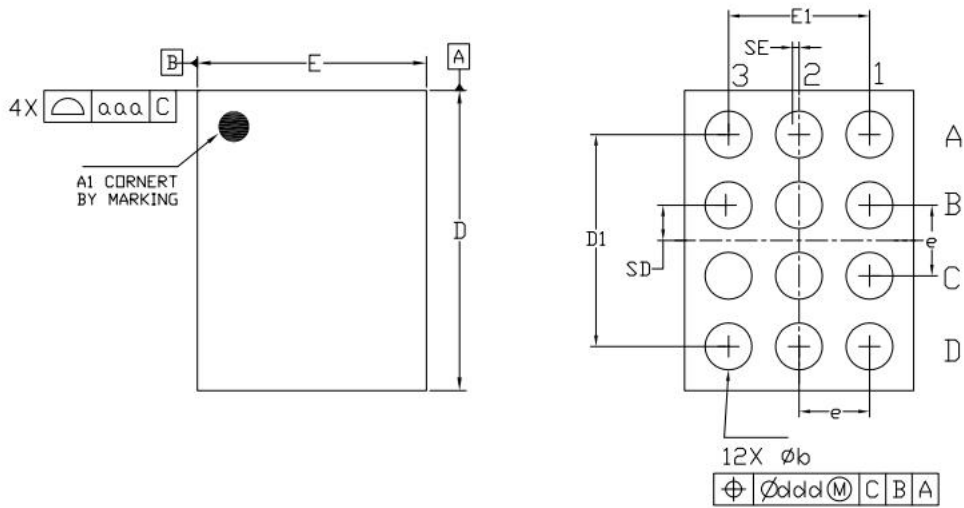

Dimensional Ref.			
REF.	Min.	Nom.	Max.
A	0.500	0.550	0.600
A1	0.175	0.200	0.225
A2	0.300	0.325	0.350
A3	0.020	0.025	0.030
D	1.655	1.670	1.685
E	1.255	1.270	1.285
D1	1.150	1.200	1.250
E1	0.750	0.800	0.850
b	0.215	0.265	0.315
e	0.400 BSC		
SD	0.200 BSC		
SE	0.000 BSC		
Tol. of Form&Position			
aaa	0.10		
bbb	0.10		
ccc	0.05		
ddd	0.05		

Notes

1. ALL DIMENSIONS ARE IN MILLIMETERS (ANGLES IN DEGREES).
2. DIMENSIONING AND TOLERANCING PER ANSI Y14.5M-1994.

TAPE AND REEL INFORMATION

REEL DIMENSIONS

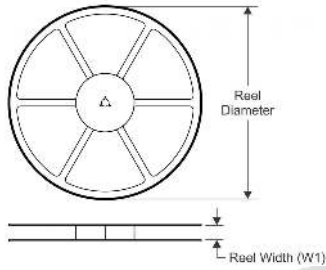

QUADRANT ASSIGNMENTS PIN 1 ORIENTATION TAPE

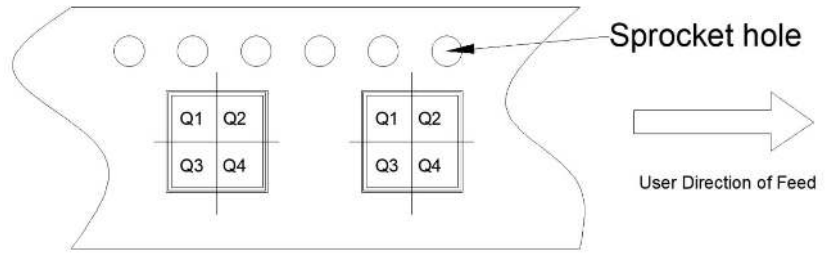

TAPE DIMENSIONS

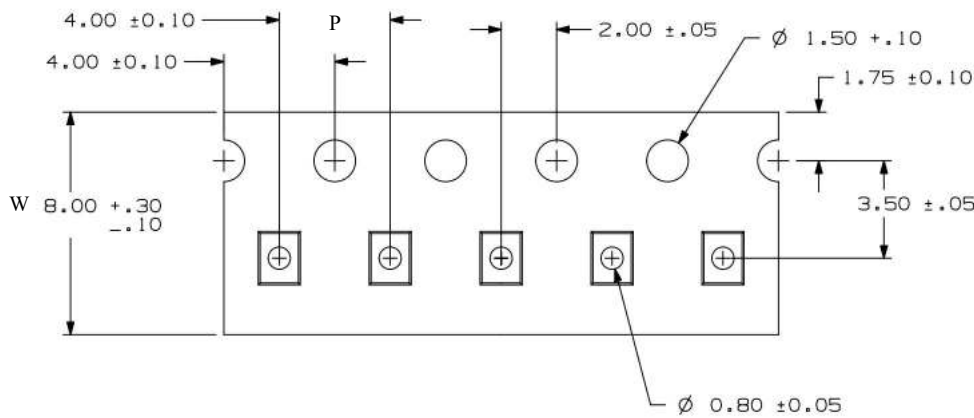

POWER

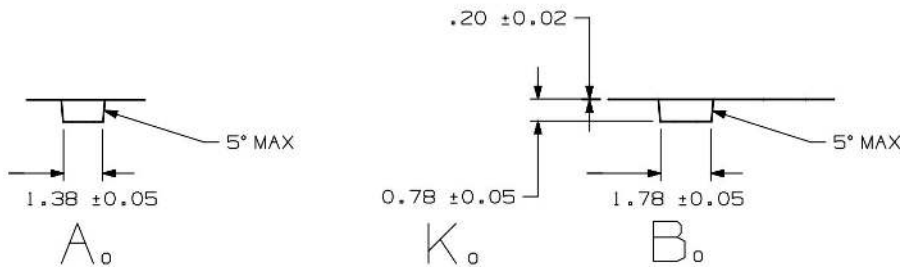

Device	Package	Pins	SPQ	Reel Diameter (mm)	Reel Width W1	A0	B0	K0	P	W	Pin1
GLF74139	WLCSP	12	3000	180	9	1.38	1.78	0.78	4	8	Q1

Remark:

A0: Dimension designed to accommodate the component width

B0: Dimension designed to accommodate the component length

C0: Dimension designed to accommodate the component thickness

W: Overall width of the carrier tape

P: Pitch between successive cavity centers

SPECIFICATION DEFINITIONS

Document Type	Meaning	Product Status
Target Specification	This is a target specification intended to support exploration and discussion of critical needs for a proposed or target device. Spec limits including typical, minimum, and maximum values are desired, or target, limits. GLF reserves the right to change limits at any time without warning or notification. A target specification in no way guarantees future production of the device in question.	Design / Development
Preliminary Specification	This is a draft version of a product specification. The specification is still under internal review and subject to change. GLF reserves the right to change the specification at any time without warning or notification. A preliminary specification in no way guarantees future production of the device in question.	Qualification
Product Specification	This document represents the anticipated production performance characteristics of the device.	Production

DISCLAIMERS

Information in this document is believed to be accurate and reliable, however GLF assumes no liability for errors or omissions. Device performance may be impacted by testing methods and application use cases. Users are responsible to independently evaluate the applicability, usability, and suitability of GLF devices in their application. In no case will GLF be liable for incidental, indirect, or consequential damages associated with the use, mis-use, or sale of its product. Customers are wholly responsible to assure GLF devices meet their system level and end product requirements. GLF retains the right to change the information provided in this data sheet without notice.