

TPS2384 Eight Port EVM

This User's Guide describes the TPS2384 Eight Port EVM (HPA152). This guide contains the EVM schematic, bill of materials and assembly drawings.

Contents

1	Introduction	1
2	Hardware Overview	1
3	EVM Operation.....	2
4	Bill of Materials	10
5	EVM Board Layout and Schematic	13

List of Figures

1	EVM Board Top Layer.....	13
2	EVM Board Silkscreen	14
3	EVM Board Layout 2.....	15
4	EVM Board Layout 3.....	16
5	EVM Board Layout 4.....	17
6	EVM Board Layout 5	18

List of Tables

1	HPA152 Bill of Materials	10
---	--------------------------------	----

1 Introduction

This User's Guide describes the setup and operation of the TPS2384 Eight Port EVM (HPA152). Information and instruction presented throughout this document assumes user familiarity with the MSP430, the TPS2384 and with the IEEE 802.3af Specification for Power Over Ethernet.

2 Hardware Overview

The HPA152 EVM features the TPS2384 made by Texas Instruments, Inc. The EVM has been designed to be configured as both an Endpoint PSE or a Midspan PSE using two TPS2384 devices to create eight IEEE 802.3af Ethernet ports.

Each TPS2384 controls four ports. The HPA152 EVM uses an MSP430 and custom firmware written by TI to operate in Power Management Mode (PMM). However, if necessary, the MSP430 can be bypassed and both TPS2384 devices can be configured to operate in Auto Mode (AM).

3 EVM Operation

3.1 Power Management Mode Operation

The HPA152 is configured at the factory for Power Management Mode. It also has firmware loaded into the MSP430 that can be exercised using the GUI available from the TI website. An external 48 volt power supply connected to J43 pin 1 (positive) and J43 pin 3 (negative) is required. This power supply provides the bias for the TPS2384 devices and is also used as the voltage source sent down the Ethernet cable. An external 3.3 volt power supply connected to J2 pin 2 (positive) and J2 pin 4 (negative) is also needed. The 3.3 volt power supply is used to bias the MSP430 and all the port LEDs.

The following jumpers are installed in the factory. For jumper function information, see section 3.3.

J3, J9–J14, J31–J34, J45, J46, J50–J52, J54–J56, J74–J77, J87, J88	Jumper installed
J15–J18, J27–J30,	Jumper installed between pin 1 and pin 2
J47–J49	Jumper installed between pin 2 and pin 3
J58–J61, J70–J73	Jumper installed between pin 1 and pin 2

Switch S1 and S2 are used to simulate power rail status inputs to the MSP430. Both must be set to a logic high (switch S1 is set towards R19 and switch S2 is set towards R20 on PCB).

Depressing the RESET button will generate a logic low signal to the RST* input of the MSP430 which will in turn generate a logic low signal to the PORB input of the TPS2384 which will reset all internal state machines and registers.

The firmware has been designed to control both TPS2384 devices on the HPA152 EVM. Each TPS2384 has an associated I2C Address Bus. This Address is set by S3 and S5. S3 sets the I2C Address for U8 to '01' and S5 sets the I2C Address for U13 to '02'.

I2C Address Settings:	
S3 switch 6	Open
S3 switch 5	Open
S3 switch 4	Open
S3 switch 3	Open
S3 switch 2	Open
S3 switch 1	Closed
S5 switch 6	Open
S5 switch 5	Open
S5 switch 4	Open
S5 switch 3	Open
S5 switch 2	Closed
S5 switch 1	Open

3.2 Connectors

J1	RS232 communications connector
J2	3.3V power input connector
J6	Host I2C interface connector
J7	MSP430 JTAG input connector
J43	48V power input connector
J86	Expansion connector

3.3 Jumpers

J3	Allows the MSP430 to control the Mode Select input to the TPS2384s via an opto-coupler.
J4	If the MSP430 control of the Mode Select is not used, this jumper can be used to set the state of the Mode Select input to the TPS2384 devices. Setting the jumper between MS and 3.3V sets the board in Power Management Mode. Setting the jumper between MS and GND will place the module in Auto Mode.
J5	Can be used to monitor the RS232 communications between the host PC and the MSP430.
J8	Allows the user to manually pull-up or connect to ground the PORB signal going to the TPS2384 devices. If PORB is under MSP430 control, this jumper must be left open. If Auto Mode of the TPS2384 devices is desired, this jumper can be installed between PORB and 3.3V to keep the board reset input inactive.
J9	Allows the MSP430 to control the PORB input to the TPS2384 devices. If Auto Mode is desired, this jumper should be removed.
J10	Connects the MSP430 P6.3 GPIO to the clock input (CLK-1) of the LED Control Circuit.
J11	Connects the MSP430 P1.3 GPIO to the I2C Serial Clock lines on the TPS2384 devices.
J12	Connects the MSP430 P6.4 GPIO to the data input (DATA-1) of the LED Control Circuit.
J13	Connects the MSP430 P1.2 GPIO to the I2C Serial Data lines on the TPS2384 devices.
J14	Connects the MSP430 P6.5 GPIO to the latch input (LATCH-1) of the LED Control Circuit.
J31	Places D25 in the circuit to indicate that Port 0 is powered. This jumper should not be installed if operating in AC Disconnect mode. The additional load generated by this circuit will keep the port from powering off after the PD has been removed.
J32	Places D27 in the circuit to indicate that Port 1 is powered. This jumper should not be installed if operating in AC Disconnect mode. The additional load created by this circuit will keep the port from powering off after the PD has been removed.
J33	Places D29 in the circuit to indicate that Port 2 is powered. This jumper should not be installed if operating in AC Disconnect mode. The additional load generated by this circuit will keep the port from powering off after the PD has been removed.
J34	Places D31 in the circuit to indicate that Port 3 is powered. This jumper should not be installed if operating in AC Disconnect mode. The additional load created by this circuit will keep the port from powering off after the PD has been removed.
J44	Can be used to ground the CT input of U8. See the TPS2384 datasheet for details.
J45	Makes the SCL1 connection between the opto-coupler and the TPS2384 devices.
J46	Makes the SDA_IN connection between the opto-coupler and the TPS2384 devices.
J47	Allows AltA/B of the TPS2384 devices to be set to a logic high or a logic low. See the TPS2384 datasheet for details.
J48	Allows MS of the TPS2384 devices to be set to a logic high or a logic low. See the TPS2384 datasheet for details. If used to set MS, J53 must be removed to prevent the opto-coupler from trying to drive this signal.
J49	Allows WDIS of the TPS2384 devices to be set to a logic high or a logic low. See the TPS2384 datasheet for details.
J50	When used with J51, allows the S4 reset switch to be placed in the circuit. J50 and J51 should only be installed if J52 is not installed.
J51	Provides an external pull-up to the POR inputs of the TPS2384 devices. This jumper should only be installed if J52 is not installed.
J52	Makes the PORB1 connection between the opto-coupler and the TPS2384 devices.
J53	Makes the MS1 connection between the opto-coupler and the TPS2384 devices.
J54	When installed, allows U8 to receive 48 volts.
J55	Allows the TPS2384 3.3V output to supply power to the opto-couplers. If an external 3.3V supply is used to power the opto-couplers, this jumper must be removed.
J56	Makes the SDA_OUT connection between the TPS2384 devices and the opto-coupler.
J57	Allows the TPS2384 port outputs (ports 0 thru 3) to be monitored or connected elsewhere.
J74	Places D62 in the circuit to indicate that Port 4 is powered. This jumper should not be installed if operating in AC Disconnect mode. The additional load generated by this circuit will keep the port from powering off after the PD has been removed.
J75	Places D64 in the circuit to indicate that Port 5 is powered. This jumper should not be installed if operating in AC Disconnect mode. The additional load created by this circuit will keep the port from powering off after the PD has been removed.
J76	Places D66 in the circuit to indicate that Port 6 is powered. This jumper should not be installed if operating in AC Disconnect mode. The additional load generated by this circuit will keep the port from powering off after the PD has been removed.
J77	Places D68 in the circuit to indicate that Port 7 is powered. This jumper should not be installed if operating in AC Disconnect mode. The additional load created by this circuit will keep the port from powering off after the PD has been removed.
J87	Allows the SYN output of U8 to control the SYN input of U13.
J88	When installed, allows U13 to receive 48 volts.
J89	Allows the TPS2384 port outputs (ports 4 thru 7) to be monitored or connected elsewhere.

3.4 Port Power Configuration

In *Power Management Mode*, the HPA152 can be commanded via the GUI to discover, classify and power up IEEE 802.3af compliant Powered Devices (PDs). Power will be applied to the Ethernet port on either the spare pairs or on the data lines of the RJ-45 connector. The HPA152 EVM is designed with jumper blocks which allow the user to configure the method in which power is applied to the PD. The following tables can be used to help the user set the appropriate jumpers depending on the desired power delivery configuration. Even though the tables show all ports being configured the same way, each port can be configured independently of all other ports.

The following configuration inserts 48 volts on the spare pins of the RJ-45 connectors (positive on pins 4 and 5 and negative on pins 7 and 8).				
Port 0 Configuration:				
	Jumper Block	1	2	3
	J16	X	X	
	J27	X	X	
	J36			
	J35			
Port 1 Configuration:				
	Jumper Block	1	2	3
	J17	X	X	
	J30	X	X	
	J38			
	J37			
Port 2 Configuration:				
	Jumper Block	1	2	3
	J15	X	X	
	J28	X	X	
	J40			
	J39			
Port 3 Configuration:				
	Jumper Block	1	2	3
	J18	X	X	
	J29	X	X	
	J42			
	J41			
Port 4 Configuration:				
	Jumper Block	1	2	3
	J58	X	X	
	J70	X	X	
	J79			
	J78			
Port 5 Configuration:				
	Jumper Block	1	2	3
	J59	X	X	
	J71	X	X	
	J81			
	J80			
Port 6 Configuration:				
	Jumper Block	1	2	3
	J60	X	X	

The following configuration inserts 48 volts on the spare pins of the RJ-45 connectors (positive on pins 4 and 5 and negative on pins 7 and 8).

	J72	X	X	
	J83			
	J82			

Port 7 Configuration:

	Jumper Block	1	2	3
	J61	X	X	
	J73	X	X	
	J85			
	J84			

The following configuration inserts 48 volts on the spare pins of the RJ-45 connectors (positive on pins 7 and 8 and negative on pins 4 and 5).

Port 0 Configuration:

	Jumper Block	1	2	3
	J16		X	X
	J27		X	X
	J36			
	J35			

Port 1 Configuration:

	Jumper Block	1	2	3
	J17		X	X
	J30		X	X
	J38			
	J37			

Port 2 Configuration:

	Jumper Block	1	2	3
	J15		X	X
	J28		X	X
	J40			
	J39			

Port 3 Configuration:

	Jumper Block	1	2	3
	J18		X	X
	J29		X	X
	J42			
	J41			

Port 4 Configuration:

	Jumper Block	1	2	3
	J58		X	X
	J70		X	X
	J79			
	J78			

Port 5 Configuration:

	Jumper Block	1	2	3
	J59		X	X
	J71		X	X
	J81			
	J80			

The following configuration inserts 48 volts on the spare pins of the RJ-45 connectors (positive on pins 7 and 8 and negative on pins 4 and 5).				
Port 6 Configuration:				
	Jumper Block	1	2	3
	J60		X	X
	J72		X	X
	J83			
	J82			
Port 7 Configuration:				
	Jumper Block	1	2	3
	J61		X	X
	J73		X	X
	J85			
	J84			

The following configuration inserts 48 volts on the data pair pins of the RJ-45 connectors (positive on pins 1 and 2 and negative on pins 3 and 6).				
Port 0 Configuration:				
	Jumper Block	1	2	3
	J16			
	J27			
	J36	X	X	
	J35	X	X	
Port 1 Configuration:				
	Jumper Block	1	2	3
	J17			
	J30			
	J38	X	X	
	J37	X	X	
Port 2 Configuration:				
	Jumper Block	1	2	3
	J15			
	J28			
	J40	X	X	
	J39	X	X	
Port 3 Configuration:				
	Jumper Block	1	2	3
	J18			
	J29			
	J42	X	X	
	J41	X	X	
Port 4 Configuration:				
	Jumper Block	1	2	3
	J58			
	J70			
	J79	X	X	
	J78	X	X	
Port 5 Configuration:				
	Jumper Block	1	2	3
	J59			

The following configuration inserts 48 volts on the data pair pins of the RJ-45 connectors (positive on pins 1 and 2 and negative on pins 3 and 6).				
	J71			
	J81	X	X	
	J80	X	X	
Port 6 Configuration:				
	Jumper Block	1	2	3
	J60			
	J72			
	J83	X	X	
	J82	X	X	
Port 7 Configuration:				
	Jumper Block	1	2	3
	J61			
	J73			
	J85	X	X	
	J84	X	X	

The following configuration inserts 48 volts on the data pair pins of the RJ-45 connectors (positive on pins 3 and 6 and negative on pins 1 and 2).				
Port 0 Configuration:				
	Jumper Block	1	2	3
	J16			
	J27			
	J36		X	X
	J35		X	X
Port 1 Configuration:				
	Jumper Block	1	2	3
	J17			
	J30			
	J38		X	X
	J37		X	X
Port 2 Configuration:				
	Jumper Block	1	2	3
	J15			
	J28			
	J40		X	X
	J39		X	X
Port 3 Configuration:				
	Jumper Block	1	2	3
	J18			
	J29			
	J42		X	X
	J41		X	X
Port 4 Configuration:				
	Jumper Block	1	2	3
	J58			
	J70			
	J79		X	X
	J78		X	X

The following configuration inserts 48 volts on the data pair pins of the RJ-45 connectors (positive on pins 3 and 6 and negative on pins 1 and 2).				
Port 5 Configuration:				
	Jumper Block	1	2	3
	J59			
	J71			
	J81		X	X
	J80		X	X
Port 6 Configuration:				
	Jumper Block	1	2	3
	J60			
	J72			
	J83		X	X
	J82		X	X
Port 7 Configuration:				
	Jumper Block	1	2	3
	J61			
	J73			
	J85		X	X
	J84		X	X

3.5 Test Points

The HPA152 EVM has been design with numerous test points. When making measurements, the user needs to be aware of which side of the isolation barrier is needed for referencing test equipment. Also, all eight Integration capacitor test points require special equipment (see table below for more information).

Test Points	Description
TP1	Ground Reference Point for MSP430 side of isolation barrier.
TP2	Ground Reference Point for MSP430 side of isolation barrier.
TP3	Ground Reference Point for MSP430 side of isolation barrier.
TP4	Test point for monitoring the 48V_AC voltage source.
TP5	Test point for monitoring the 48V_SW voltage source.
TP6	Test point for monitoring the voltage ramp on the A/D integration capacitor for port 3. This is a high impedance input and performance may be affected by any additional impedance. It is recommended that a low capacitance/FET input buffer be used when monitoring this test point.
TP7	Test point for monitoring the voltage ramp on the A/D integration capacitor for port 2. This is a high impedance input and performance may be affected by any additional impedance. It is recommended that a low capacitance/FET input buffer be used when monitoring this test point.
TP8	Test point for monitoring AC_HI on U8
TP9	Test point for monitoring AC_LO on U8
TP10	Test point for monitoring SYN.
TP11	Test point for monitoring Ct.
TP12	Test point for monitoring the 2.5V internal bias source.
TP13	Test point for monitoring SDA.
TP14	Test point for monitoring SDA-I.
TP15	Test point for monitoring SCL.
TP16	Test point for monitoring the 3.3V voltage source.
TP17	Ground Reference point for TPS2384 side of isolation barrier.
TP18	Test point for monitoring the 10V internal bias source.
TP19	Test point for monitoring the 6.3V internal bias source.
TP20	Test point for monitoring WD_DIS.

Test Points	Description
TP21	Ground Reference point for TPS2384 side of isolation barrier.
TP22	Test point for monitoring INT.
TP23	Test point for monitoring POR
TP24	Test point for monitoring the voltage ramp on the A/D integration capacitor for port 0. This is a high impedance input and performance may be affected by any additional impedance. It is recommended that a low capacitance/FET input buffer be used when monitoring this test point.
TP25	Test point for monitoring the voltage ramp on the A/D integration capacitor for port 1. This is a high impedance input and performance may be affected by any additional impedance. It is recommended that a low capacitance/FET input buffer be used when monitoring this test point.
TP26–TP29	Ground Reference point for TPS2384 side of isolation barrier.
TP30	Test point for monitoring the voltage ramp on the A/D integration capacitor for port 6. This is a high impedance input and performance may be affected by any additional impedance. It is recommended that a low capacitance/FET input buffer be used when monitoring this test point.
TP31	Test point for monitoring the voltage ramp on the A/D integration capacitor for port 7. This is a high impedance input and performance may be affected by any additional impedance. It is recommended that a low capacitance/FET input buffer be used when monitoring this test point.
TP32	Test point for monitoring AC_HI on U13
TP33	Test point for monitoring AC_LO on U13
TP34	Test point for monitoring SYN.
TP35	Test point for monitoring Ct.
TP36	Test point for monitoring the 2.5V internal bias source.
TP37	Test point for monitoring SDA.
TP38	Test point for monitoring SDA-I.
TP39	Test point for monitoring SCL.
TP40	Test point for monitoring the 3.3V voltage source.
TP41	Ground Reference point for TPS2384 side of isolation barrier.
TP42	Test point for monitoring the 10V internal bias source.
TP43	Test point for monitoring the 6.3V internal bias source.
TP44	Test point for monitoring WD_DIS.
TP45	Ground Reference point for TPS2384 side of isolation barrier.
TP46	Test point for monitoring INT.
TP47	Test point for monitoring POR
TP48	Test point for monitoring the voltage ramp on the A/D integration capacitor for port 5. This is a high impedance input and performance may be affected by any additional impedance. It is recommended that a low capacitance/FET input buffer be used when monitoring this test point.
TP49	Test point for monitoring the voltage ramp on the A/D integration capacitor for port 4. This is a high impedance input and performance may be affected by any additional impedance. It is recommended that a low capacitance/FET input buffer be used when monitoring this test point.
TP50–TP53	Ground Reference point for TPS2384 side of isolation barrier.

3.6 Auto Mode Operation

The HPA152 EVM can be placed in Auto Mode by moving the jumper on J4 between MS and GND. The PORB jumper (J9) must be removed and used to pull-up the PORB input to the module by placing the jumper between PORB and 3.3V on J8.

In Auto Mode operation, the LEDs on either side of the RJ45 connectors will not operate. These LEDs are only available during Power Management Mode. However, in order to determine whether a port is powered or not, each port has a separate LED (D25, D27, D29, D31, D62, D64, D66 and D68) which turns on after the port has been classified and power is being sent to the PD. In order for these LEDs to operate, their respective jumpers need to be inserted (J31, J32, J33, J34, J74, J75, J76 and J77).

4 Bill of Materials
Table 1. HPA152 Bill of Materials

Count	RefDes	Value	Size	MFR	Part Number	Description
27	C1– C10, C35–C40, C43– C45, C48–C50, C73, C74, C76, C77, C80	0.1 μ F	1260	Std	Std	Capacitor, Ceramic, 0.1 μ F,100V, X7R
16	C11–C14, C20, C22, C24, C26, C51–C54, C60, C62, C64, C66	0.1 μ F	0805	Std	Std	Capacitor, Ceramic, 0.1 μ F,100V, X7R, 20%
16	C15–C19, C21, C23, C25, C55, C56–C59, C61, C63, C65	1000 pF	1808	TDK	C4520X7R3D102K	Capacitor, Ceramic, 1000-pF, 2000-V, X7R
8	C27–C30, C67–C70	220 nF	1210	TDK	C3225X7R2A224K	Capacitor, Ceramic, 220 nF, 100V, X7R, 10%
1	C31	68 μ F	0.670 x 0.750	Panasonic	EEV-FK2A680Q	Capacitor, Aluminum, SM, 68 μ F, 100-V,
1	C32	220 μ F	18 x 16,5 mm	Panasonic	EEVFK2A221M	Capacitor, Aluminum, 220 μ F, 100V, 20%
8	C33, C34, C46, C47, C71, C72, C78, C79	0.027 μ F	0.126 x 0.098	Panasonic	ECHU1H273GX5	Capacitor, Film Chip,0.027- μ F, 50V, 2%
1	C41	1 μ F	0805	Vishay	Std	Capacitor, Ceramic, 1- μ F, 25V, X7R, 10%
1	C42	220 pF	0805	Kemet	C0805C221FGAC7800	Capacitor, Ceramic, 220pF, 100V, C0G, 1%
0	C75	220 pF	0805	Kemet	C0805C221FGAC7800	Capacitor, Ceramic, 220pF, 100V, C0G, 1%
18	D1, D3, D5, D7, D9, D11, D13, D15, D25, D27, D29, D31, D51, D53, D62, D64, D66, D68	LN1371G	SMD	Panasonic	LN1371G	Diode, LED, Green, 20-mA, 0.9-mcd
16	D17–D24, D54–D61		SOD-323	Protek Devices	GBLC03C	Diode, TVS, 19 Clamping Voltage V, 350W
8	D2, D4, D6, D8, D10, D12, D14, D16		0.114 x 0.049 in	Panasonic	LN1471Y	Diode, LED, Amber, 20-mA, -.4-mcd
8	D26, D28, D30, D32, D63, D65, D67, D69			ON Semiconducto r	1SMB5932BT3	Zener Diode, 20V, 3W
8	D33–D36, D70–D73		SMA	ST	EB2BA	Diode, Schottky, 2A, 100V
16	D37, D38, D40, D42–D45, D47, D74–D77, D82–D85		SMA	St	STPS1H100A	Diode, Schottky, 1A, 100V
8	D39, D41, D46, D48, D78–D81		SMA	Littelfuse	SMAJ10A	Diode, Transient Voltage Suppressor, 400W, 10V
1	D49		SMA	Diodes Inc.	SMAJ12A	Diode, Zener, 12-V, 1W
1	D50		SMA	Diodes	SMAJ58A	Diode, SMT TVS 400W, 58V
1	D52		SMA	Diodes Inc.	1SMA5919BT3	Diode, Zener
1	D86		SMA	Diodes Inc.	S2B-13	Diodes Rectifier, 1.5A 100V

Table 1. HPA152 Bill of Materials (continued)

Count	RefDes	Value	Size	MFR	Part Number	Description
8	F1–F8		TH	Raychem	RXE090	Polyswitch, 0.47 Ω Max, 40 A Max, 72 V Max
1	J1		TH	Norcomp	182-009-212-171	Connector, 9-pin D, Right Angle, Female
8	J19, J21, J23, J25, J62, J64, J66, J68	RJ-45	TH	AMP	556416	Connector, Jack, Modular, 8 POS
8	J20, J22, J24, J26, J63, J65, J67, J69	RJ-45	TH	AMP	520252-4	Connector, Jack, Modular, Rt, Angle, 8 POS
2	J6, J43		TH	Weidmüller	1793830000	Header, 6-pin, 150mil spacing
2	J6, J43, Socket		Socket	Weidmüller	1798890000	Header, 6-pin, Socket 150mil spacing
1	J2			Weidmüller	1793810000	Header, 4-pin, 150mil spacing
1	J2, Socket			Weidmüller	1798870000	Header, 4-pin, Socket 150mil spacing
27	J3, J9–J14, J31–J34, J44–J46, J50–J56, J74–J77, J87, J88		0.100 x 2	Sullins	PTC36SAAN	Header, 2-pin, 100 mil spacing
38	J4, J5, J8, J15–J18, J27–J30, J35–J42, J47–J49, J58–J61, J70–J73, J78–J85		0.100 x 3	Sullins	PTC36SAAN	Header, 3-pin, 100 mil spacing
2	J57, J89		0.100 x 8 in	Sullins	PTC36SAAN	Header, 8-pin, 100 mil spacing
2	J7, J86		0.100 x 2x7	3M	2514-6002UB	Connector, Straight 2x7 pin, 100 mil spacing
8	L1–L8		0.320 x 0.198	Coilcraft	TTDLF2500	Inductor, 2 Lines, 0.500A, 5 μ H
1	Q1		D2PAK	IR	IRF540NS	Transistor, NFET, 100V, 33A, 44 m Ω
1	Q2		SOT23		BSS119E6327	MOSFET, N-ch, 100-V, 0.17-A, zz-m Ω
1	Q3		SOT23	Fairchild	FDV301N	MOSFET, N-ch, 25-V, 220-mA, 5 Ω
17	R1–R3, R5–R7, R10, R11, R13, R18, R21– R26, R80	330	0805	Vishay	Std	Resistor, Chip, 330- Ω , 1/10W, 5%
4	R12, R14, R66, R67	2K	0805	Vishay	Std	Resistor, Chip, 2-k Ω , 1/10W, 5%
1	R16	68.1K	0805	Std	Std	Resistor, Chip, 68.1-k Ω , 1/10W, 5%
32	R28–R35, R40–R47, R81–R88, R93–R100	85	0603	Std	Std	Resistor, Chip, 75 Ω , 1/10W, 5%
9	R36–R39, R68, R89–R92	10K	0805	Std	Std	Resistor, Chip, 10 k Ω , 1/10W, 5%
8	R48–R51, R101–R104	7.5K	0805	Std	Std	Resistor, Chip, 7.5 Ω , 1/10W, 5%
1	R52	100 Ω	0805	Std	Std	Resistor, Chip, 100 Ω , 1/10W, 5%
1	R53	0.01	2512	IRC	LCR-LRF2512-01-RO10-F	Resistor, Metal Strip, 0.01 Ω , 2W, 1%
1	R55	187K	0805	Std	Std	Resistor, Chip, 187 k Ω , 1/10W, 5%
1	R56	69.8K	0805	Std	Std	Resistor, Chip, 69.8 k Ω , 1/10W, 1%
4	R57–R60	3.3K	0805	Std	Std	Resistor, Chip, 3.3 k Ω , 1/10W, 5%

Table 1. HPA152 Bill of Materials (continued)

Count	RefDes	Value	Size	MFR	Part Number	Description
16	R4, R15, R17, R19, R20, R54, R61–R65, R106–R110	100K	0805	Std	Std	Resistor, Chip, 100 k Ω , 1/10W, 5%
2	R59, R71	200	0805	Std	Std	Resistor, Chip, 200 k Ω , 1/10W, 5%
2	R70, R77	1K	0805	Std	Std	Resistor, Chip, 1 k Ω , 1/10W, 5%
2	R72, R111	124K	0805	Std	Std	Resistor, Chip, 124 k Ω , 1/10W, 0.1%
2	R73, R76	300	0805	Std	Std	Resistor, Chip, 300 Ω , 1/10W, 5%
2	R74, R75	3.9K	0805	Std	Std	Resistor, Chip, 3.9 k Ω , 1/10W, 5%
1	R78	7.15K	0805	Std	Std	Resistor, Chip, 7.5 k Ω , 1/10W, 5%
5	R8, R9, R27, R79, R105	0 Ω	0805	Std	Std	Resistor, Chip, 0 Ω , 1/10W, 1%
2	S1, S2		0.46 x 0.16	E_Switch	EG1218	Switch, 1P2T, Slide, PC-mount, 200-mA
2	S3, S5		0.60 x 0.40 in	Grayhill	76SB06S	Switch, 6-pole DIP, Raised Rocker
2	S4, S6		0.245 x 0.251	C & K	KT11P2JM	Switch, SPST, PB Momentary, Sealed Washable
8	T1–T8		0.500 x 0.370	Pulse	H2019	Xfmr, Center-tapped, Voice Over Ip
45	TP1–TP25, TP30–TP49		TH	Keystone	5012	Test Point, White, 0.062 Hole
8	TP26–TP29, TP50–TP53		SM	Keystone	5016	Test Point, SM, 0.150 x 0.090 in
1	U1		SSOP-16	Maxim	MAX3221ECAE	IC, RS-232 Transceivers with AutoShutdown
1	U10		SO-8	NEC	PS8802-2-A	IC, Optocoupler, Dual Open Collector Output
1	U11		SO14	TI	SN74LVC06A	IC, High-Speed CMOS Logic Hex Inverting Schmitt Trigger
1	U12		SO-8	NEC	PS9821-1-A	IC, Optocoupler, Single Open Collector Output
1	U2		QFP-64	TI	MSP430F169PM	IC, Mixed Signal Microcontroller
2	U3, U5		TVSOP-20	TI	SN74ALVCH373DGVR	IC, Octal Transparent D-Type Latch/3-State Outputs
2	U4, U6		TSSOP-14	TI	SN74HC164PW	IC, 8-Bit Parallel-Out Serial Shift Registers
1	U7		DGS10	TI	TPS2490DGS	IC, TPS2490DGS
2	U8, U113		PWFQ-64	TI	TPS2384PAP	IC, Quad Ethernet Power Sourcing
1	U9		SO-8	NEC	PS8821-2-A	IC, Optocouper, Dual Open Collector Output
1	X1	6–8 MHz	0.394 x 0.197	ECS	ZTT8.00MT	Crystal, 8.00 MHz
1				Any	HPA152	PCB, 7.250 in x 12.25 in x 0.062 in
35				Sullins	STC02SYAN	Shunts
12				SPC Technology	2563	Rubber Bumpers

Notes:

1. These assemblies are ESD sensitive, ESD precautions shall be observed.
2. These assemblies must be clean and free from flux and all contaminants. Use of no clean flux is not acceptable.
3. These assemblies must comply with workmanship standards IPC-A-610 Class 2.
4. Ref designators marked with an asterisk (***) cannot be substituted. All other components can be substituted with equivalent MFR's components.
5. Add 12 rubber bumpers to the bottom side of the board; 4 from left to right top, 4 from left to right bottom, and 4 from left to right middle

4.1 Related Documentation From Texas Instruments

1. TPS2384 Power Over Ethernet Quad PSE, data sheet, SLUS634
2. MSP430 data sheet, SLAS368

5 EVM Board Layout and Schematic

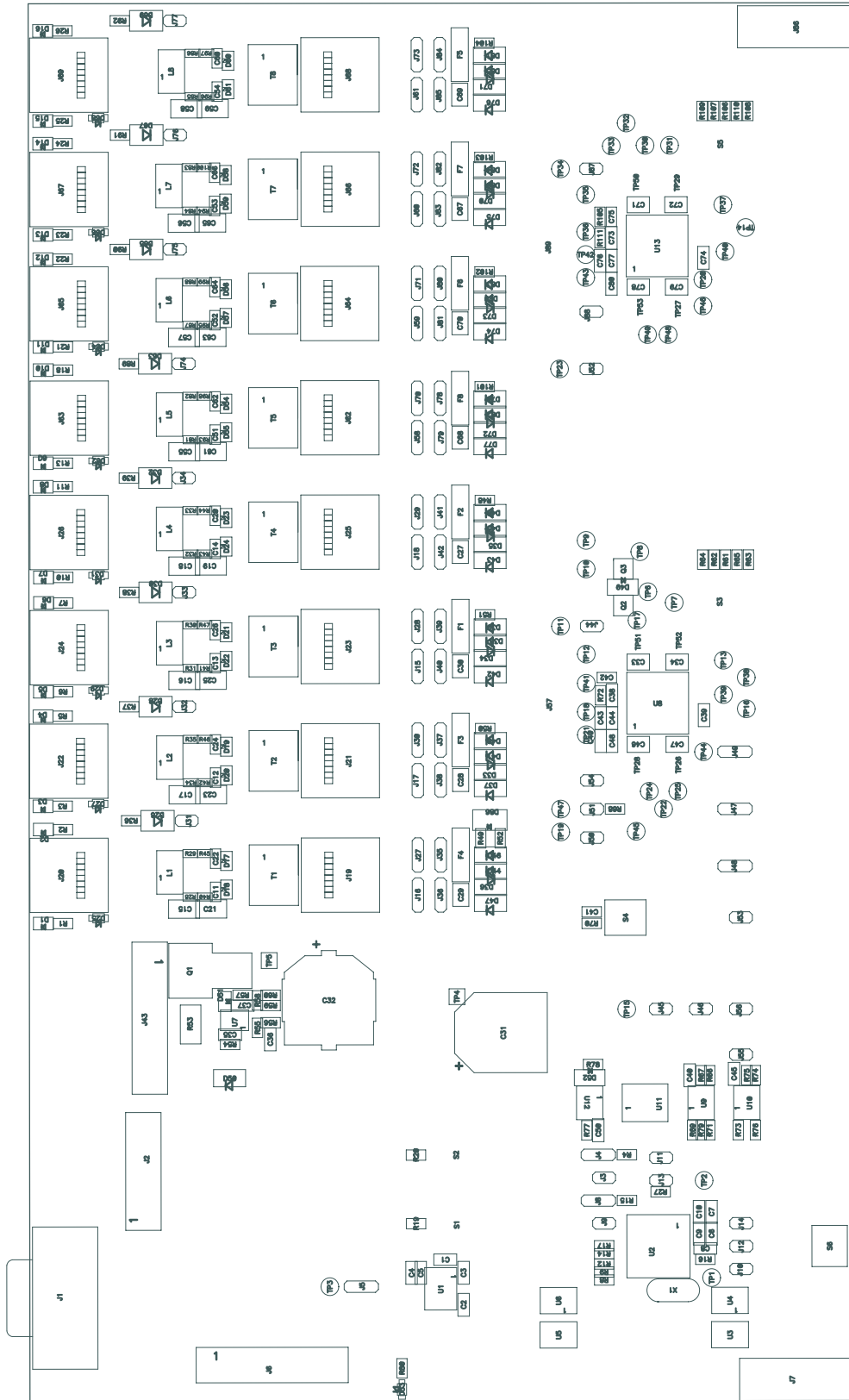

Figure 1. EVM Board Top Layer

EVM Board Layout and Schematic

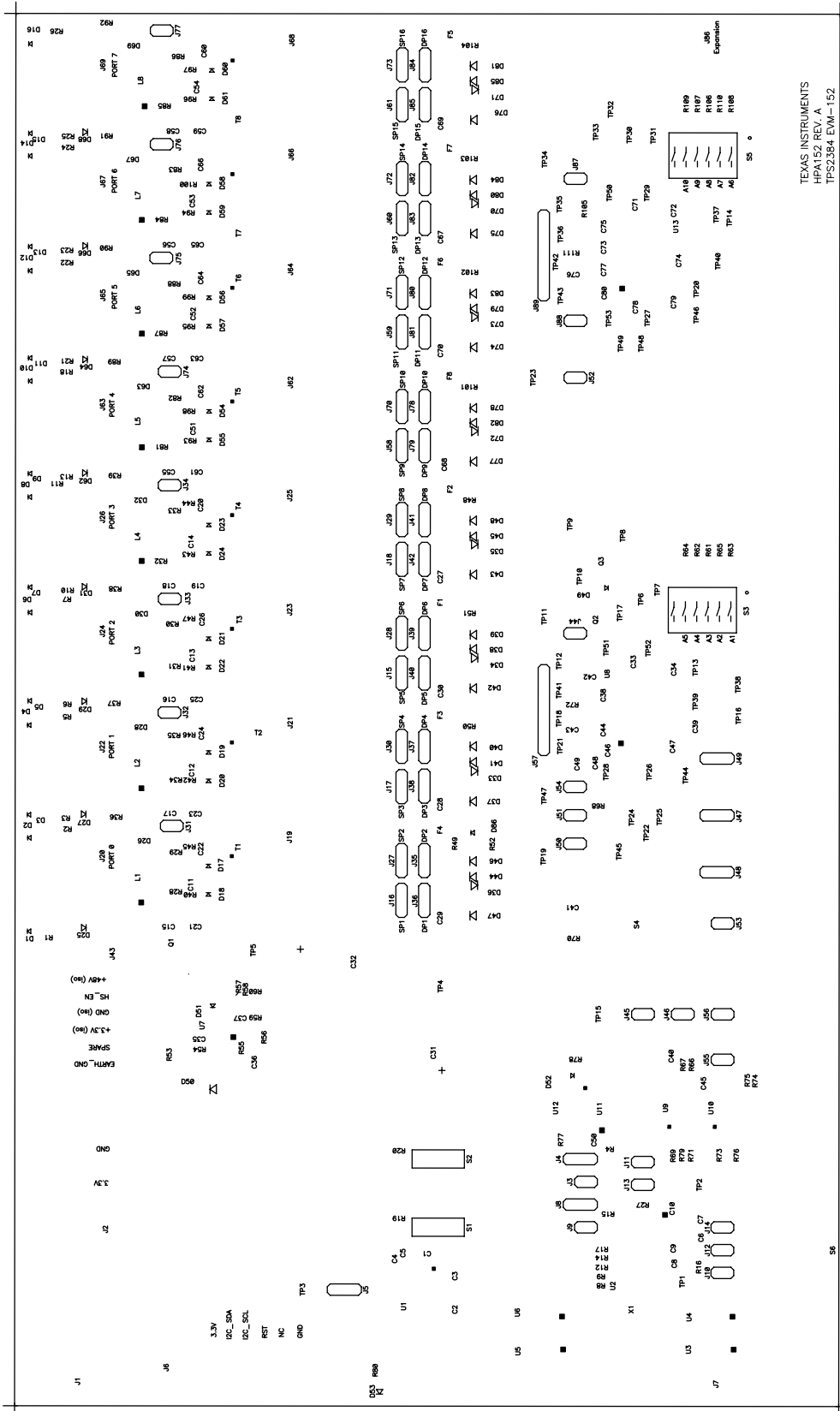

Figure 2. EVM Board Silkscreen

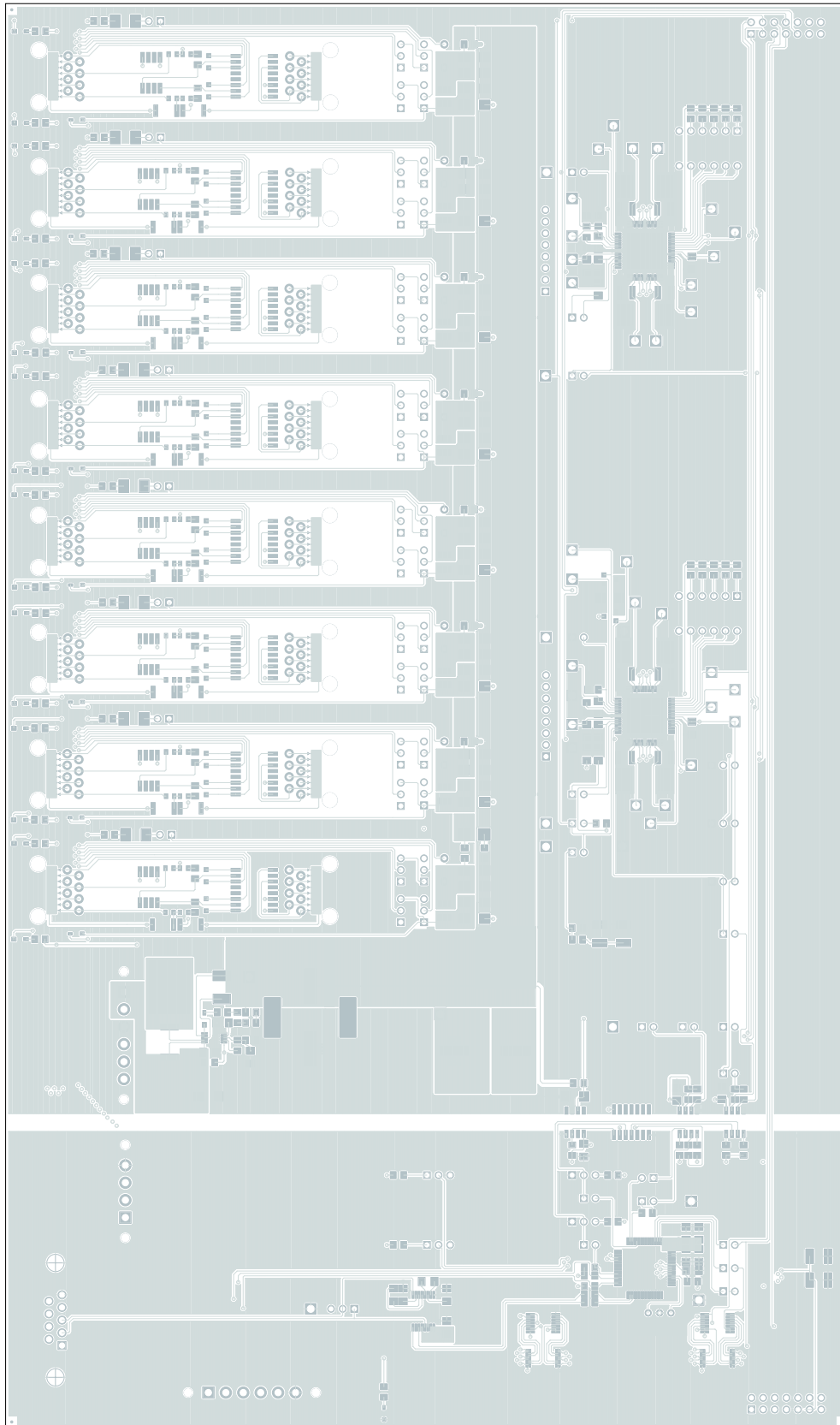

Figure 3. EVM Board Layout 2



Figure 4. EVM Board Layout 3

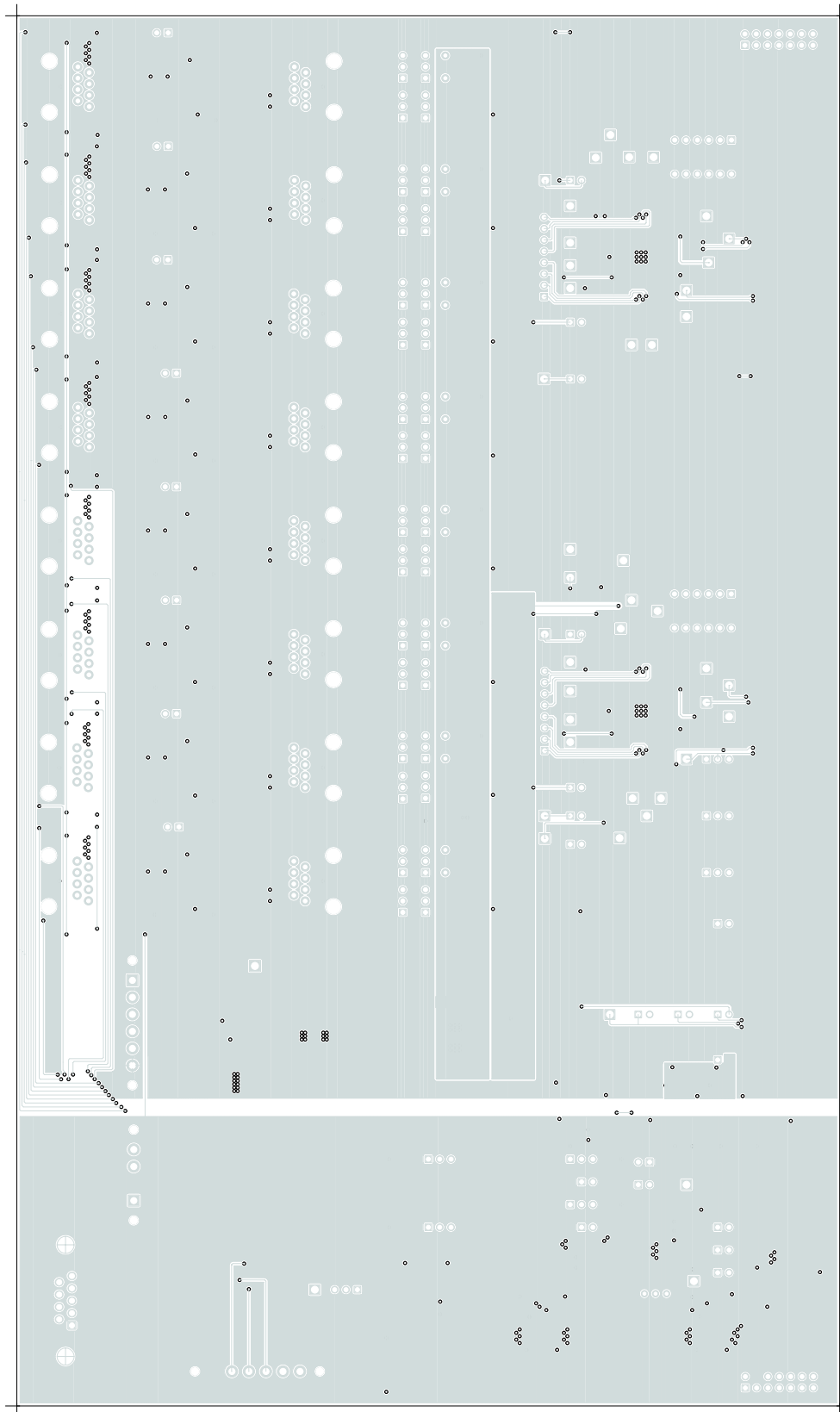

Figure 5. EVM Board Layout 4

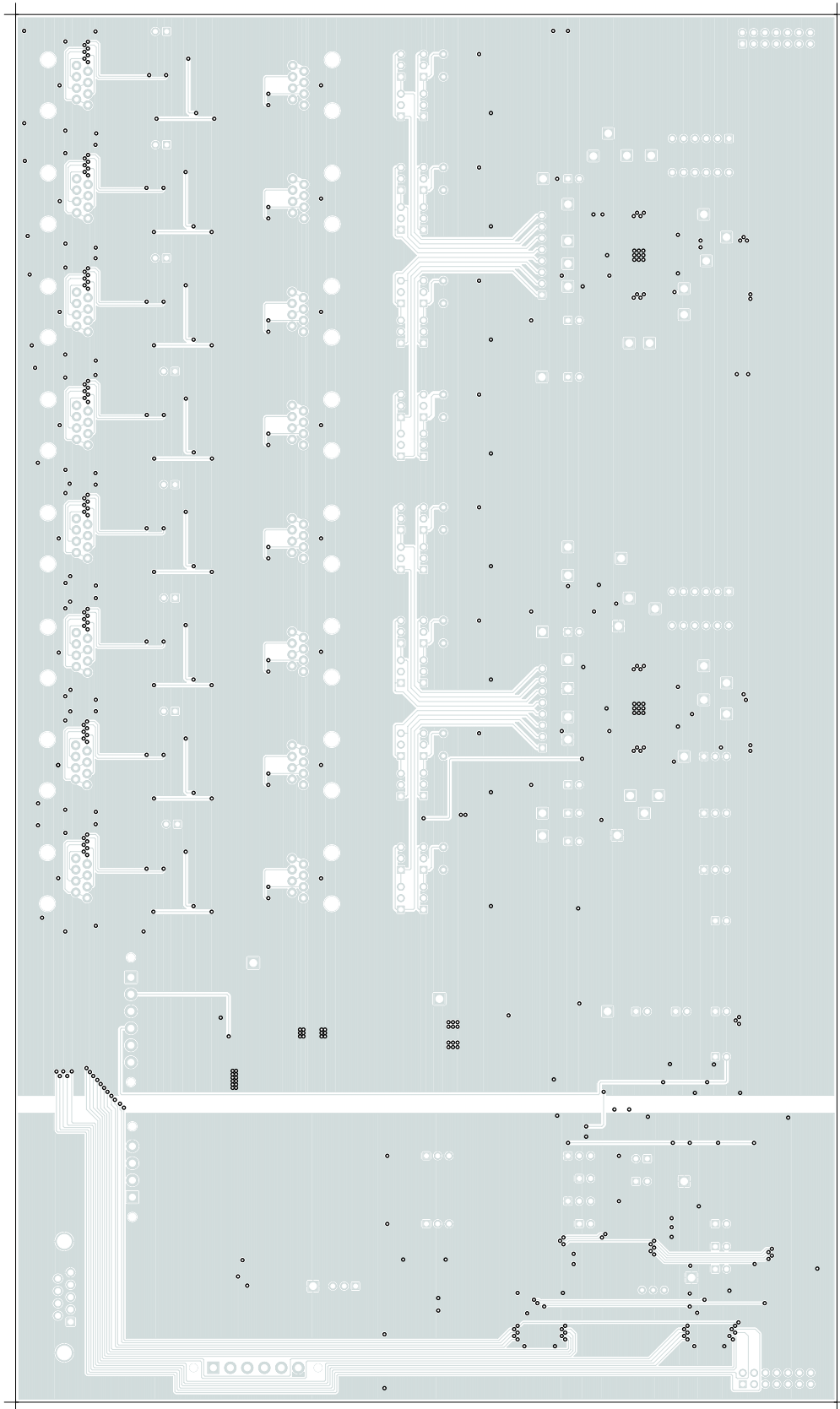

Figure 6. EVM Board Layout 5

FCC Warnings

This equipment is intended for use in a laboratory test environment only. It generates, uses, and can radiate radio frequency energy and has not been tested for compliance with the limits of computing devices pursuant to subpart J of part 15 of FCC rules, which are designed to provide reasonable protection against radio frequency interference. Operation of this equipment in other environments may cause interference with radio communications, in which case the user at his own expense will be required to take whatever measures may be required to correct this interference.

EVM IMPORTANT NOTICE

Texas Instruments (TI) provides the enclosed product(s) under the following conditions:

This evaluation kit being sold by TI is intended for use for **ENGINEERING DEVELOPMENT OR EVALUATION PURPOSES ONLY** and is not considered by TI to be fit for commercial use. As such, the goods being provided may not be complete in terms of required design-, marketing-, and/or manufacturing-related protective considerations, including product safety measures typically found in the end product incorporating the goods. As a prototype, this product does not fall within the scope of the European Union directive on electromagnetic compatibility and therefore may not meet the technical requirements of the directive.

Should this evaluation kit not meet the specifications indicated in the EVM User's Guide, the kit may be returned within 30 days from the date of delivery for a full refund. **THE FOREGOING WARRANTY IS THE EXCLUSIVE WARRANTY MADE BY SELLER TO BUYER AND IS IN LIEU OF ALL OTHER WARRANTIES, EXPRESSED, IMPLIED, OR STATUTORY, INCLUDING ANY WARRANTY OF MERCHANTABILITY OR FITNESS FOR ANY PARTICULAR PURPOSE.**

The user assumes all responsibility and liability for proper and safe handling of the goods. Further, the user indemnifies TI from all claims arising from the handling or use of the goods. Please be aware that the products received may not be regulatory compliant or agency certified (FCC, UL, CE, etc.). Due to the open construction of the product, it is the user's responsibility to take any and all appropriate precautions with regard to electrostatic discharge.

EXCEPT TO THE EXTENT OF THE INDEMNITY SET FORTH ABOVE, NEITHER PARTY SHALL BE Liable to the other FOR ANY INDIRECT, SPECIAL, INCIDENTAL, OR CONSEQUENTIAL DAMAGES.

TI currently deals with a variety of customers for products, and therefore our arrangement with the user **is not exclusive**.

TI assumes **no liability for applications assistance, customer product design, software performance, or infringement of patents or services described herein.**

Please read the EVM User's Guide and, specifically, the EVM Warnings and Restrictions notice in the EVM User's Guide prior to handling the product. This notice contains important safety information about temperatures and voltages. For further safety concerns, please contact the TI application engineer.

Persons handling the product must have electronics training and observe good laboratory practice standards.

No license is granted under any patent right or other intellectual property right of TI covering or relating to any machine, process, or combination in which such TI products or services might be or are used.

Mailing Address: Texas Instruments, Post Office Box 655303, Dallas, Texas 75265
Copyright © 2006, Texas Instruments Incorporated

EVM WARNINGS AND RESTRICTIONS

It is important to operate this EVM within the input voltage range of 44 V to 57 V. Maximum recommended output load is 48 V at 500 mA .

Exceeding the specified input range may cause unexpected operation and/or irreversible damage to the EVM. If there are questions concerning the input range, please contact a TI field representative prior to connecting the input power.

During normal operation, some circuit components may have case temperatures greater than 50°C . The EVM is designed to operate properly with certain components above 50°C as long as the input and output ranges are maintained. These components include but are not limited to linear regulators, switching transistors, pass transistors, and current sense resistors. These types of devices can be identified using the EVM schematic located in the EVM User's Guide. When placing measurement probes near these devices during operation, please be aware that these devices may be very warm to the touch.

Mailing Address: Texas Instruments, Post Office Box 655303, Dallas, Texas 75265
Copyright © 2006, Texas Instruments Incorporated

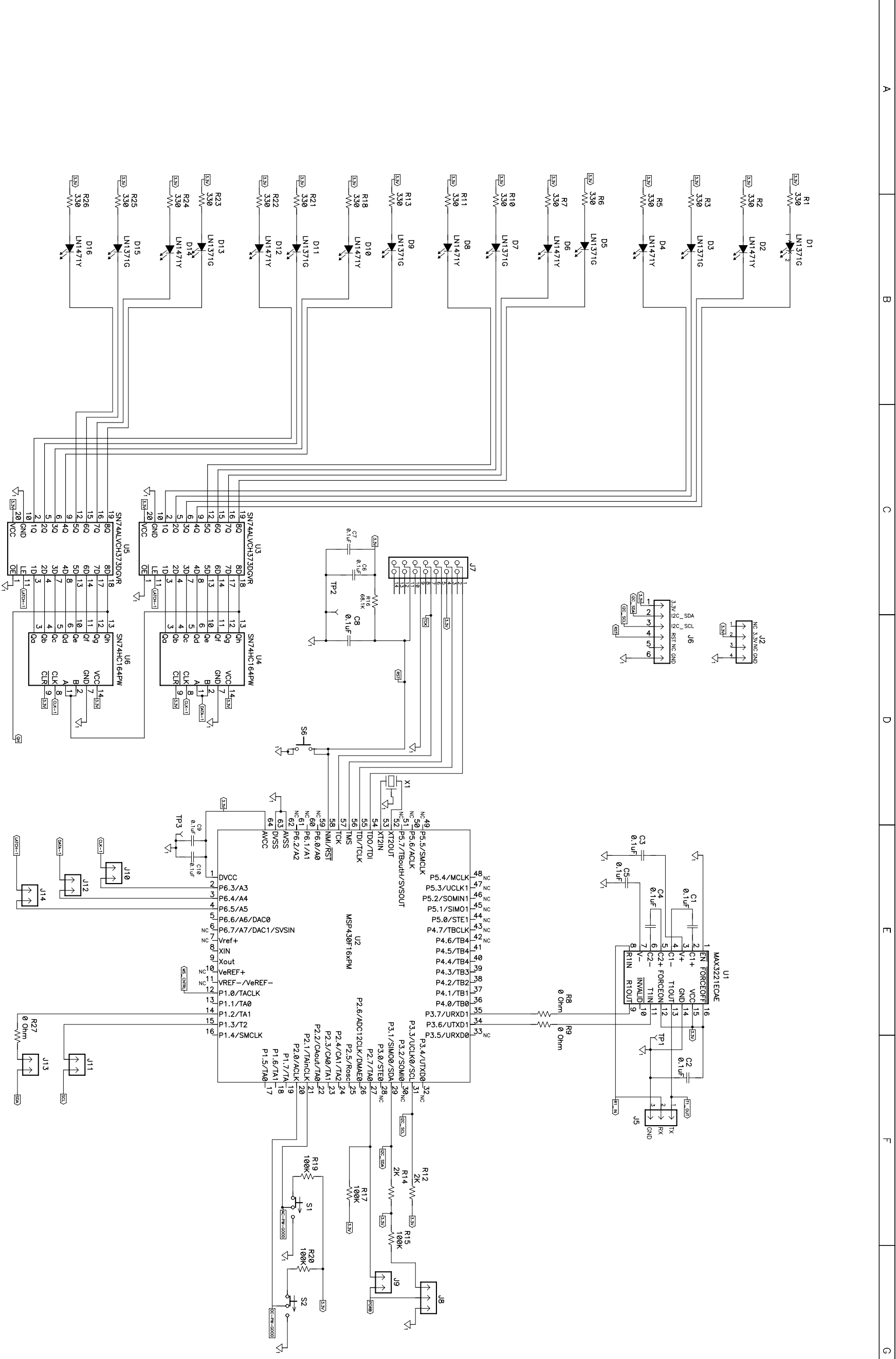

1	8 Port W/O MODULE	HPA152	TEXAS INSTRUMENTS	Rev A
2	Size D	Number HPA152	Date Wed Nov 30, 2005	Drawn by {Drawn By}
3	Title	HPA152A.sch	Filename	Sheet 1 of 1

Δ NOT USED

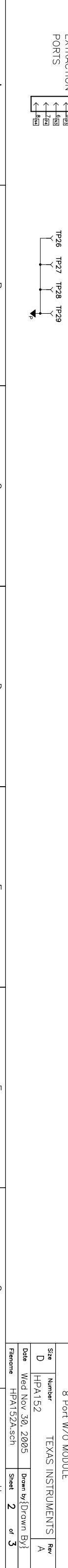
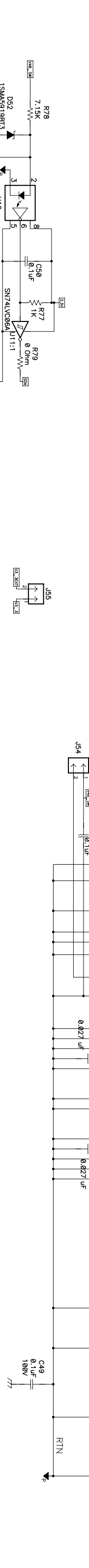
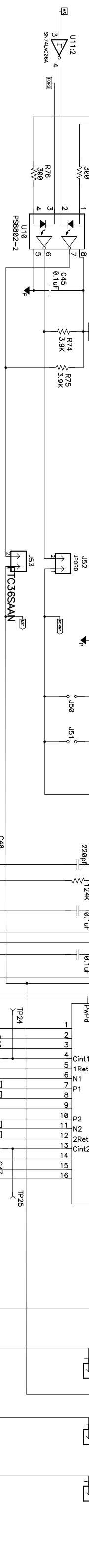
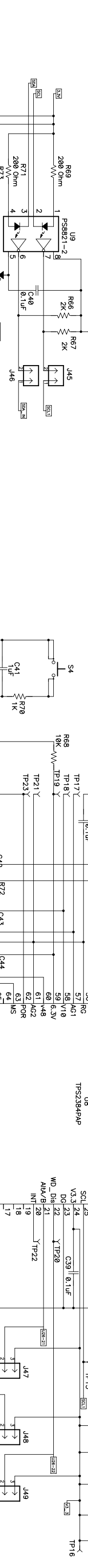
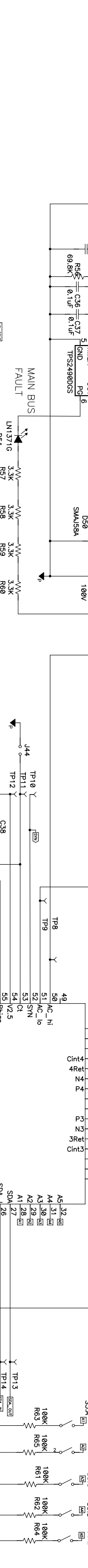
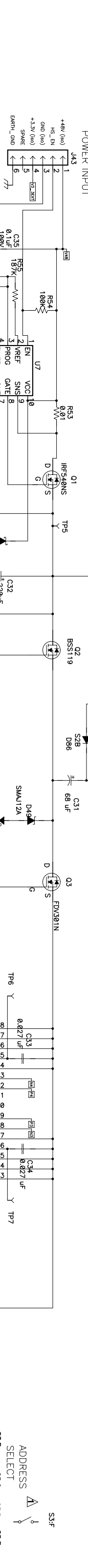
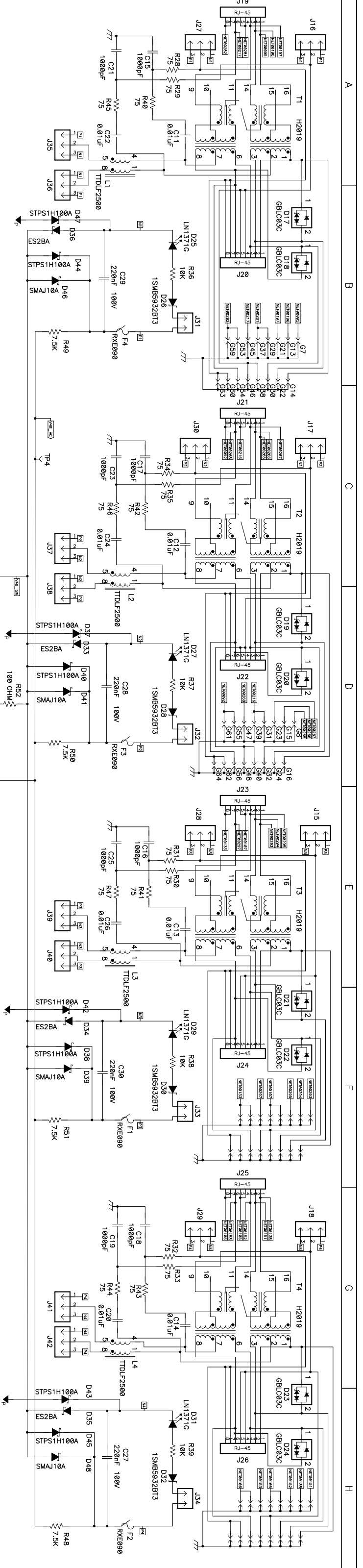

Title	8 Port W/O MODULE
Size	D
Number	HPA152
Rev	A
Date	Wed Nov 30, 2005
Filename	HPA152A.sch
Drawn by	Drawn BY
Sheet	2 of 3

▲ NOT USED

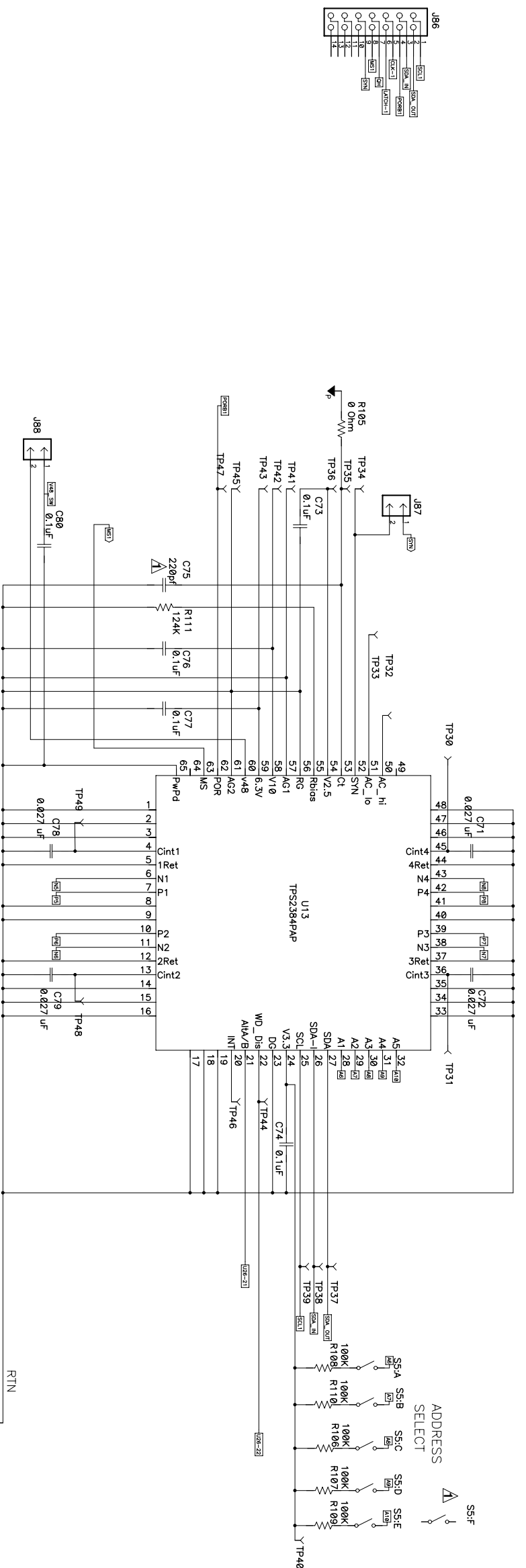
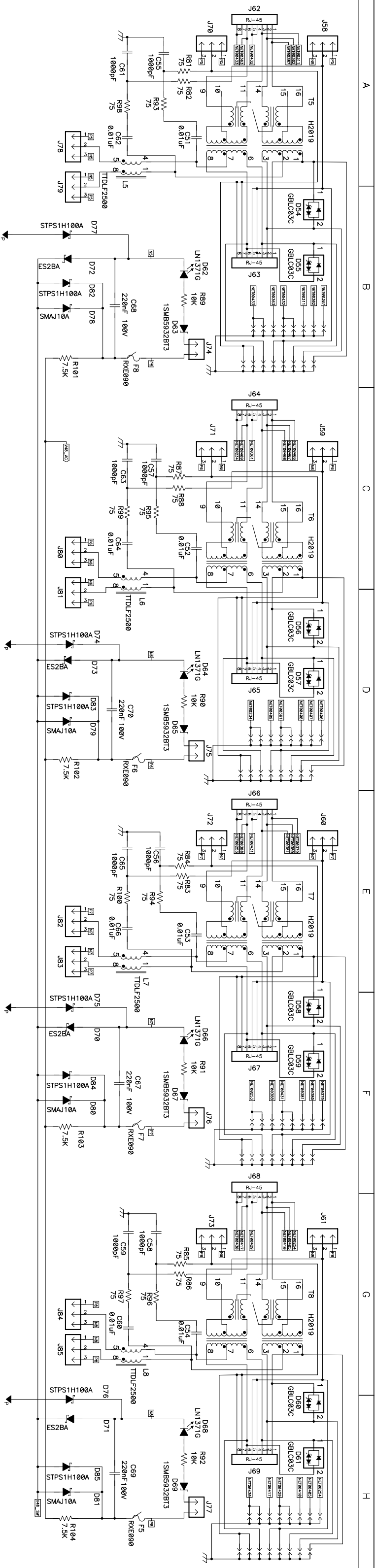

Δ NOT USED

Title	8 Port W/O MODULE		
Size	Number	TEXAS INSTRUMENTS Rev A	
D	HPA152		
Date	Wed Nov 30, 2005	Drawn by	{Drawn By}
Filename	HPA152A.sch	Sheet	3 of 3

IMPORTANT NOTICE

Texas Instruments Incorporated and its subsidiaries (TI) reserve the right to make corrections, modifications, enhancements, improvements, and other changes to its products and services at any time and to discontinue any product or service without notice. Customers should obtain the latest relevant information before placing orders and should verify that such information is current and complete. All products are sold subject to TI's terms and conditions of sale supplied at the time of order acknowledgment.

TI warrants performance of its hardware products to the specifications applicable at the time of sale in accordance with TI's standard warranty. Testing and other quality control techniques are used to the extent TI deems necessary to support this warranty. Except where mandated by government requirements, testing of all parameters of each product is not necessarily performed.

TI assumes no liability for applications assistance or customer product design. Customers are responsible for their products and applications using TI components. To minimize the risks associated with customer products and applications, customers should provide adequate design and operating safeguards.

TI does not warrant or represent that any license, either express or implied, is granted under any TI patent right, copyright, mask work right, or other TI intellectual property right relating to any combination, machine, or process in which TI products or services are used. Information published by TI regarding third-party products or services does not constitute a license from TI to use such products or services or a warranty or endorsement thereof. Use of such information may require a license from a third party under the patents or other intellectual property of the third party, or a license from TI under the patents or other intellectual property of TI.

Reproduction of information in TI data books or data sheets is permissible only if reproduction is without alteration and is accompanied by all associated warranties, conditions, limitations, and notices. Reproduction of this information with alteration is an unfair and deceptive business practice. TI is not responsible or liable for such altered documentation.

Resale of TI products or services with statements different from or beyond the parameters stated by TI for that product or service voids all express and any implied warranties for the associated TI product or service and is an unfair and deceptive business practice. TI is not responsible or liable for any such statements.

TI products are not authorized for use in safety-critical applications (such as life support) where a failure of the TI product would reasonably be expected to cause severe personal injury or death, unless officers of the parties have executed an agreement specifically governing such use. Buyers represent that they have all necessary expertise in the safety and regulatory ramifications of their applications, and acknowledge and agree that they are solely responsible for all legal, regulatory and safety-related requirements concerning their products and any use of TI products in such safety-critical applications, notwithstanding any applications-related information or support that may be provided by TI. Further, Buyers must fully indemnify TI and its representatives against any damages arising out of the use of TI products in such safety-critical applications.

TI products are neither designed nor intended for use in military/aerospace applications or environments unless the TI products are specifically designated by TI as military-grade or "enhanced plastic." Only products designated by TI as military-grade meet military specifications. Buyers acknowledge and agree that any such use of TI products which TI has not designated as military-grade is solely at the Buyer's risk, and that they are solely responsible for compliance with all legal and regulatory requirements in connection with such use.

TI products are neither designed nor intended for use in automotive applications or environments unless the specific TI products are designated by TI as compliant with ISO/TS 16949 requirements. Buyers acknowledge and agree that, if they use any non-designated products in automotive applications, TI will not be responsible for any failure to meet such requirements.

Following are URLs where you can obtain information on other Texas Instruments products and application solutions:

Products		Applications	
Amplifiers	amplifier.ti.com	Audio	www.ti.com/audio
Data Converters	dataconverter.ti.com	Automotive	www.ti.com/automotive
DSP	dsp.ti.com	Broadband	www.ti.com/broadband
Interface	interface.ti.com	Digital Control	www.ti.com/digitalcontrol
Logic	logic.ti.com	Military	www.ti.com/military
Power Mgmt	power.ti.com	Optical Networking	www.ti.com/opticalnetwork
Microcontrollers	microcontroller.ti.com	Security	www.ti.com/security
RFID	www.ti-rfid.com	Telephony	www.ti.com/telephony
Low Power Wireless	www.ti.com/lpw	Video & Imaging	www.ti.com/video
		Wireless	www.ti.com/wireless

Mailing Address: Texas Instruments, Post Office Box 655303, Dallas, Texas 75265
Copyright © 2007, Texas Instruments Incorporated