



AMP | AMP Type III+

TE Internal #: 1-66360-2

Power Contacts, Contact, Tin, 18 – 14 AWG Wire Size, .8 – 2 mm²

Wire Size, Wire & Cable, Crimp, Power & Signal, Socket, AMP Type III+

[View on TE.com >](#)

Connectors > Power Connectors > Power Contacts > Pin and Socket Contacts, Type III, LP



Power Contact Type: **Contact**

Contact Mating Area Plating Material: **Tin**

Wire Size: **.8 – 2 mm²**

Connector & Contact Terminates To: **Wire & Cable**

[All Pin and Socket Contacts, Type III, LP \(53\)](#)

Features

Product Type Features

Power Contact Type	Contact
Connector & Contact Terminates To	Wire & Cable

Contact Features

Contact Size	Size 16
Contact Mating Area Plating Material	Tin
Contact Current Rating (Max)	13 A
Contact Type	Socket
Contact Retention Within Housing	With
Mating Pin Diameter	1.57 mm[.062 in]
Contact Base Material	Brass
Contact Mating Area Plating Material Thickness	2.54 μm[100 μin]
Contact Mating Area Plating Material Finish	Bright
Wire Contact Termination Area Plating Thickness	2.54 μm[100 μin]

Wire Contact Termination Area Plating Material	Tin
Wire Contact Termination Area Plating Material Finish	Matte
Contact Orientation	Straight
Contact Underplating Material	Nickel
Contact Underplating Material Thickness	.76 μm[30 μin]

Termination Features

Termination Method to Wire & Cable	Crimp
------------------------------------	-------

Mechanical Attachment

Wire Insulation Support	With
-------------------------	------

Dimensions

Wire Size	.8 – 2 mm ²
Compatible Insulation Diameter Range	2.03 – 2.54 mm[.08 – .1 in]

Usage Conditions

Operating Temperature Range	-55 – 90 °C[-67 – 194 °F]
-----------------------------	---------------------------

Operation/Application

Circuit Application	Power & Signal
---------------------	----------------

Packaging Features

Packaging Quantity	1000
Packaging Method	Carton, Loose Piece

Other

Power Connectors Comment	Insertion Tool No. 91002-1 (for Insulation Dia. 1.78 [.07] or less), No. 200893-2 (for Insulation Dia. .09 [2.29] max.) Extraction Tool No. 305183., Overall insulation crimp diameter, including crimp barrel, must not exceed 3.18 [.125].
--------------------------	--

Product Compliance

[For compliance documentation, visit the product page on TE.com>](#)

EU RoHS Directive 2011/65/EU	Compliant
EU ELV Directive 2000/53/EC	Compliant
China RoHS 2 Directive MIIT Order No 32, 2016	No Restricted Materials Above Threshold
EU REACH Regulation (EC) No. 1907/2006	Current ECHA Candidate List: JUNE 2023 (235)











Candidate List Declared Against: JUNE 2023 (235)
Does not contain REACH SVHC

Halogen Content	Low Halogen - Br, Cl, F, I < 900 ppm per homogenous material. Also BFR/CFR/PVC Free
Solder Process Capability	Not applicable for solder process capability

Product Compliance Disclaimer

This information is provided based on reasonable inquiry of our suppliers and represents our current actual knowledge based on the information they provided. This information is subject to change. The part numbers that TE has identified as EU RoHS compliant have a maximum concentration of 0.1% by weight in homogenous materials for lead, hexavalent chromium, mercury, PBB, PBDE, DBP, BBP, DEHP, DIBP, and 0.01% for cadmium, or qualify for an exemption to these limits as defined in the Annexes of Directive 2011/65/EU (RoHS2). Finished electrical and electronic equipment products will be CE marked as required by Directive 2011/65/EU. Components may not be CE marked. Additionally, the part numbers that TE has identified as EU ELV compliant have a maximum concentration of 0.1% by weight in homogenous materials for lead, hexavalent chromium, and mercury, and 0.01% for cadmium, or qualify for an exemption to these limits as defined in the Annexes of Directive 2000/53/EC (ELV). Regarding the REACH Regulation, the information TE provides on SVHC in articles for this part number is based on the latest European Chemicals Agency (ECHA) 'Guidance on requirements for substances in articles' posted at this URL: <https://echa.europa.eu/guidance-documents/guidance-on-reach>

Compatible Parts

 <p>TE Part # CAT-AM71-C83998C Circular Plastic Connector, CMC Series 1</p>	 <p>TE Part # CAT-AM71-C83998Y One-Piece Connector, Sealed, CPC Series 1</p>	 <p>TE Part # CAT-AM71-C83998J Cable/Panel Mount Connector, CPC Series 1</p>	 <p>TE Part # CAT-AM71-C83998K Circular Connector, Environmentally Sealed, CPC Series 6</p>
 <p>TE Part # 91519-1 CCII TYPE III+ PIN SKT 18-14 ASSY</p>	 <p>TE Part # 200893-2 INSERTION TOOL CONT</p>	 <p>TE Part # 539972-1 EXTRACTION TOOL</p>	 <p>TE Part # 305183 EXTRACT TOOL TYPE 2 20-16</p>

Also in the Series | **AMP Type III+**



Insertion & Extraction Tools(4)



Power Contacts(409)

Customers Also Bought



TE Part #211398-4
Cable/Panel Mount Connector, CPC
Series 1



TE Part #206708-1
CPC PLUG ASSEMBLY SIZE 13-9



TE Part #1-206062-4
CABLE CLAMP KIT #11

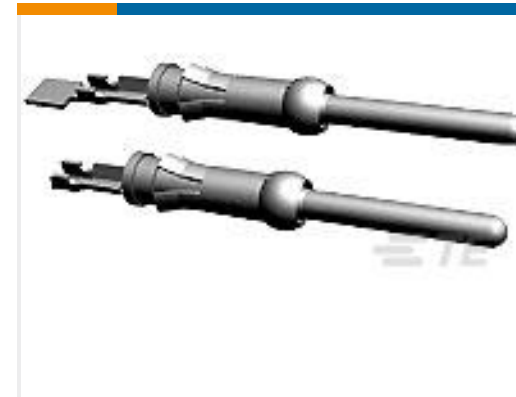

TE Part #1-66400-0
III+ PIN,24-20,TIN,LP



TE Part #794209-1
18P MINI UMNL2 CAP HSG UL94V0



TE Part #T4161210008-001
RPC-M12-MR-8CON-PVC-0.5SH



TE Part #794208-1
18P MINI UMNL2 PLUG HSG UL94V0

Documents

Product Drawings

III+ SKT,18-14,TIN ,LP

English

CAD Files

3D PDF

3D

Customer View Model

[ENG_CVM_CVM_1-66360-2_AH.2d_dxf.zip](#)

English

Customer View Model

[ENG_CVM_CVM_1-66360-2_AH.3d_igs.zip](#)

English

Customer View Model

[ENG_CVM_CVM_1-66360-2_AH.3d_stp.zip](#)

English

By downloading the CAD file I accept and agree to the [Terms and Conditions](#) of use.



Datasheets & Catalog Pages

[AMP Circular Connectors for Commercial Signal & Power Applications](#)

English

[Signal Contacts](#)

English

[M_SERIES_PIN_AND_SOCKET_CONNECTORS](#)

English

Product Specifications

[Application Specification](#)

English

Product Environmental Compliance

[MD_1-66360-2_021920182238_dmtec](#)

English

[MD_1-66360-2_021920182238_dmtec](#)

English