

AFBR-POCxxxL

Optical Power Converter



Description

AFBR-POCxxxL belongs to the Broadcom® Power Components product family and converts optical power to electrical power for applications requiring complete electrical isolation in highly demanding industrial environments. AFBR-POCxxxL is an excellent choice for powering electronic circuitry where electrically-wired solutions are not feasible due to high voltage, electromagnetic inductance, or strong magnetic fields.

AFBR-POCxxxL is a multi-junction compound semiconductor device that provides operating voltages for typical 3 VDC or 5 VDC applications, depending on the chip structure selected.

Typically 600 mW of electrical power can be supplied by converting 1.5W (CW) of optical input power over an operating temperature range from -40°C to $+85^{\circ}\text{C}$.

Smart thermal design simplifies system integration.

AFBR-POCxxxL is optimized for the efficient coupling of MM fibers with commonly available NA. All products are available with industry-standard ST or FC connectors.

The AFBR-POCx04L optical power converters provide a typical output voltage level of 4.3V supporting most 3 VDC applications. The AFBR-POCx06L converters support most 5 VDC applications by providing a typical electrical output voltage level of 6.5V.

Features

- RoHS-compliant
- Fully isolated Power over Fiber (PoF) solution that efficiently converts optical power to electrical power
- Different converter output characteristics are available for a perfect match with target applications
- Supplies typically 600 mW of electrical power
- Operating temperature range of -40°C to $+85^{\circ}\text{C}$
- Available with threaded ST and FC ports for MM fibers
- Easy heat sink mounting for thermal control
- Threaded ST port for easy panel mount

Applications

Optical power converters can power devices, such as:

- High voltage current sensors and transducers
- E-field and H-field probes
- MRI/RF imaging coils and patient monitoring equipment
- Power conditioning circuitry
- Wireless transmitters
- Aircraft sensors and transducers

Available Options

3 VDC application; ST Port	AFBR-POC404L
3 VDC application; FC Port	AFBR-POC204L
5 VDC application; ST Port	AFBR-POC406L
5 VDC application; FC Port	AFBR-POC206L

Package

The RoHS-compliant compact optical power converters are provided in solid brass housings with nickel plating.

Variants can be ordered with threaded ST or FC port protected by port caps. For added protection against electrostatic discharge the anode and cathode pins are shorted by a jumper.

For traceability, an individual serial number and a 2D Data Matrix barcode are laser engraved on one side of the housing.

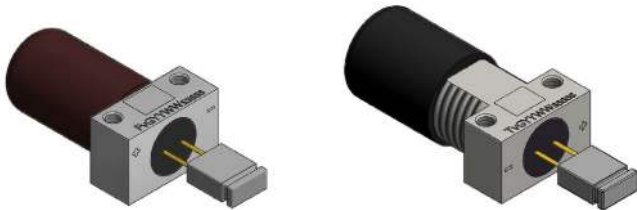

Handling and Design Information

CAUTION! These components are susceptible to damage from electrostatic discharge (ESD). Implement advanced static precautions in handling and assembling these components to prevent damage, degradation, or both that may be induced by ESD.

When soldering, it is advisable to leave the protective port cap on the unit to prevent dirt buildup in the fiber or optical assemblies. Good system performance requires clean port optics and cable ferrules to avoid obstructing the optical path.

The optic components are hermetically sealed with a glass window. Any debris or particles could obstruct the optical path and reduce the conversion efficiency.

AFBR-POCxxxL are photovoltaic devices.

Unless for controlled testing purposes, do not apply an external voltage. For testing, make sure that polarities are maintained and do not exceed the value of open circuit voltage in the forward direction. This photovoltaic device should never be exposed to reverse voltage bias.

Mechanical Dimensions – ST Port

AFBR-POC4xxL

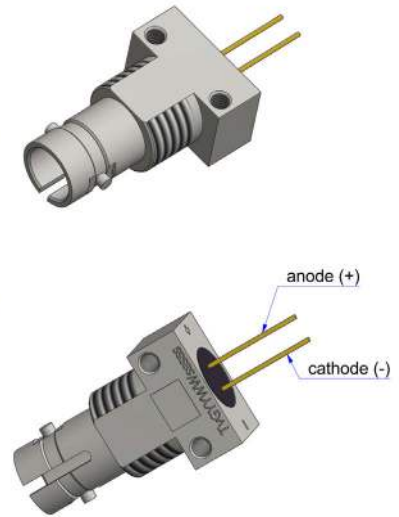
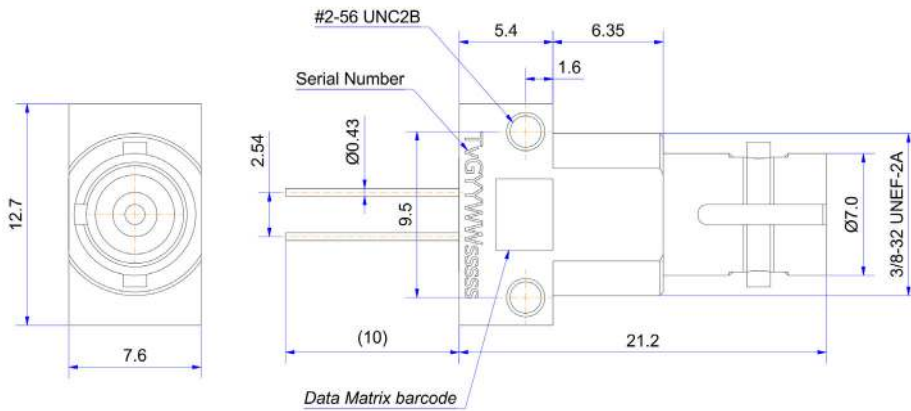

Dimensions are in mm.

Mechanical Dimensions – FC Port

AFBR-POC2xxL

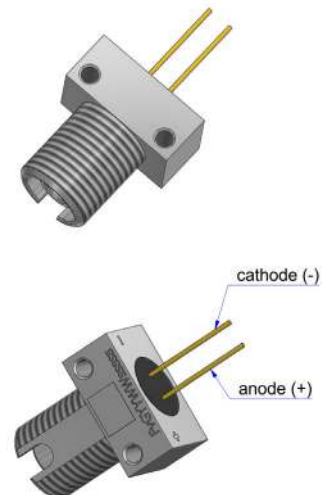
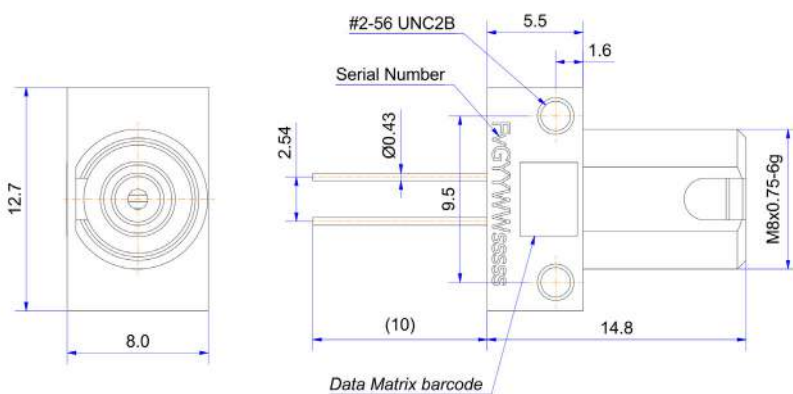

Dimensions are in mm.

Regulatory Compliance

Feature	Test Method	Performance
Electrostatic Discharge (ESD) to the Electrical Pins Human Body Model	ESDA/JEDEC – JS-001-2017	Min. $\pm 1000V$

CAUTION! These components are susceptible to damage from electrostatic discharge (ESD). Implement advanced static precautions in handling and assembling these components to prevent damage, degradation, or both that may be induced by ESD.

Process Compatibility

Parameter	Symbol	Minimum	Typical	Maximum	Units
Solder Environment ^{a, b}	T_{SOLD}	—	—	260	$^{\circ}C$
	t_{SOLD}	—	—	10	seconds

a. Maximum temperature refers to peak temperature.

b. Maximum time refers to time spent at peak temperature.

Pin Description

The anode pin side is marked with "+"; the cathode pin side is marked with "-" on the housing.

Figure 1: Polarity of AFBR-POCxxxL Devices

ST Port version

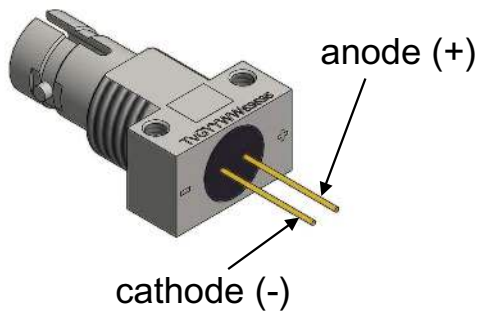

FC Port version

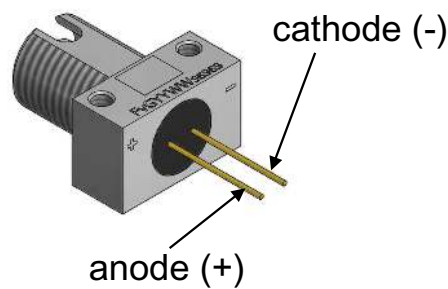

Details about AFBR-POCxxxL

- **AFBR-POCxxxL is a photovoltaic device.**

The device is a multi-junction compound semiconductor, which works as a power source without any applied external bias while providing electrical power to a load when illuminated. Unlike a standard photovoltaic device, such as a solar cell that is a large semiconductor pn-junction, the power converter area is small. Typically, the device is illuminated by light emanating from an optical fiber; therefore, the light is highly concentrated. The AFBR-POCxxxL device is uniquely designed to handle concentrated light levels, which helps to maintain high output of both voltage and current.

- **Except for controlled testing, do not apply an external voltage.**

- **Never apply a reverse bias to the device.**

- **The "+" marking on the housing stands for anode; the "-" for cathode.**

The markings also indicate the current flow from "+" to "-", when a load is connected to the pins and light is coupled into the device.

AFBR-POCxxxL devices operate without applying additional external voltage.

- **Use of voltage regulators is recommended for a stable, efficient, and controlled power extraction from AFBR-POCxxxL devices.**

Typically, photovoltaic devices, such as solar cells, do not have a continuous operating point and for optimum performance, the load must be adjusted accordingly. This adjustment is primarily due to the influence of the optical input power to the device output. Therefore, a fixed load power extraction is not an optimum method for power harvesting with solar cells.

Conversely, the Broadcom optical power converters operate with controllable laser light coupled into optical fiber, which results in stabilized output of the AFBR-POCxxxL device. For most applications, combining the device with a voltage regulator, such as a DC/DC converter, is sufficient. Integration of ICs providing automatic maximum power point tracking (MPPT) is another option.

Figure 2: Illustration of a Typical I-V Curve of Optical Power Converters

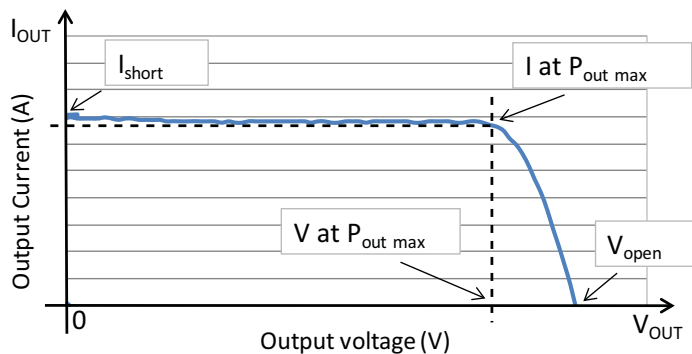

Figure 2 illustrates the typical output current vs. output voltage characteristics of an optical power converter.

At short circuit, the current output is at its maximum, but no power is delivered. At open circuit, the voltage is at its maximum; however, no power can be extracted. In between, a maximum power point exists, which is the product of the current and the voltage at that specific point. In an ideal application, the load would be tailored to that maximum power point.

Absolute Maximum Ratings

Absolute maximum ratings are those values beyond which damage to the device may occur if these limits are exceeded for other than a short period of time.

Parameter	Symbol	Min.	Typ.	Max.	Units
Storage Temperature	T_S	-40	—	85	°C
Operating Case Temperature	T_C	-40	—	85	°C
Relative Humidity	RH	5	—	85	%
Optical Input Power Range ^a	$P_{opt IN}$	—	—	1.5	W

a. Optical input power (808 nm, continuous wave) at the end of a 30m long, connectorized MM fiber measured with an optical power meter.

Fiber Specifications

Protect connectorized fiber by a sleeve or a ceramic ferrule during handling.

Parameter	Symbol	Min.	Typ.	Max.	Units
Core Diameter ^a	D	—	62.5	—	μm
Numeric Aperture	NA	0.22	—	0.375	
Fiber Length ^b	—	—	Application specific	—	meter

- a. The minimum and maximum fiber core diameter that can be used with AFBR-POCxxxL products is related to the fiber-specific numerical aperture value. Typically fibers with core diameter from 50 μm to 200 μm match with the specified NA range (0.22 to 0.375). For highest energy conversion efficiency fibers with NA from 0.22 to 0.28 are recommended.
- b. Fiber length depends on application requirements, mainly depending on fiber attenuation. Exemplarily a typical GI-MM 62.5 μm/125 μm fiber has an attenuation of around 3.5 dB/km at 830 nm.

AFBR-POCx04L

Optical power converters provide electrical output voltage levels for most 3 VDC applications.

Operating Characteristics

All specified parameters are valid for operations at 25°C case temperature and the use of a thermal interface material rated for a thermal contact resistance of less than 1.3 cm²K/W.

Parameter	Symbol	Min.	Typ. ^a	Max.	Units
Response Optical Spectrum Range ^b	λ_{IN}	800	808	850	nm
Maximum Electrical Output Power vs. Optical Input Power ^c	P_{out} at 0.1 $W_{opt IN}$	—	50	—	mW
	P_{out} at 0.2 $W_{opt IN}$	—	110	—	
	P_{out} at 0.5 $W_{opt IN}$	—	290	—	
	P_{out} at 1.0 $W_{opt IN}$	—	600	—	
	P_{out} at 1.5 $W_{opt IN}$	—	895	—	
Output Voltage at Maximum Electrical Output Power	V_{out} at 0.1 $W_{opt IN}$	—	4.1	—	V
	V_{out} at 0.2 $W_{opt IN}$	—	4.2	—	
	V_{out} at 0.5 $W_{opt IN}$	—	4.3	—	
	V_{out} at 1.0 $W_{opt IN}$	—	4.3	—	
	V_{out} at 1.5 $W_{opt IN}$	—	4.3	—	
Output Current at Maximum Electrical Output Power	I_{out} at 0.1 $W_{opt IN}$	—	13	—	mA
	I_{out} at 0.2 $W_{opt IN}$	—	26	—	
	I_{out} at 0.5 $W_{opt IN}$	—	68	—	
	I_{out} at 1.0 $W_{opt IN}$	—	140	—	
	I_{out} at 1.5 $W_{opt IN}$	—	208	—	

- Typical values are average values measured at 25°C case temperature.
- For operations over the entire temperature range, laser light with a wavelength not exceeding 830 nm is recommended.
- Optical input power (808 nm, continuous) at the end of a 30m long, connectorized MM fiber measured with an optical power meter. Valid for multimode fibers with NA from 0.22 to 0.28.

Figure 3: Typical I-V Curves (at $T_C = +25^\circ\text{C}$) of AFBR-POCx04L at Different Optical Input Power

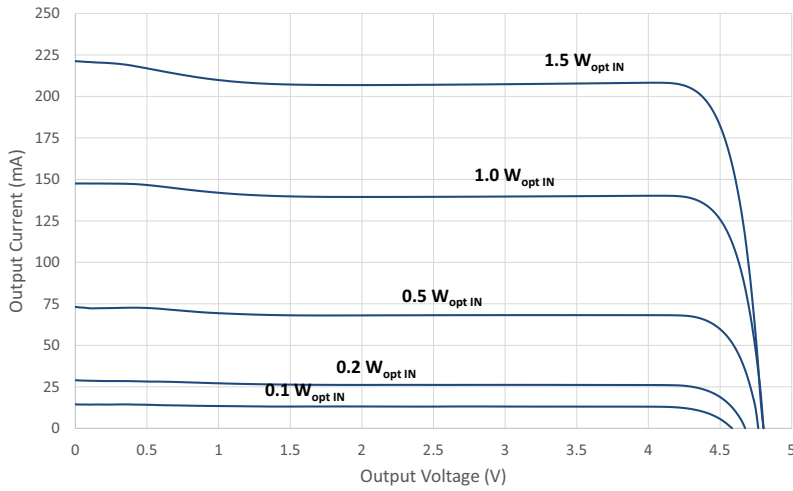

Figure 4: Typical Electrical Output Power vs. Optical Input Power of AFBR-POCx04L at Different Case Temperatures

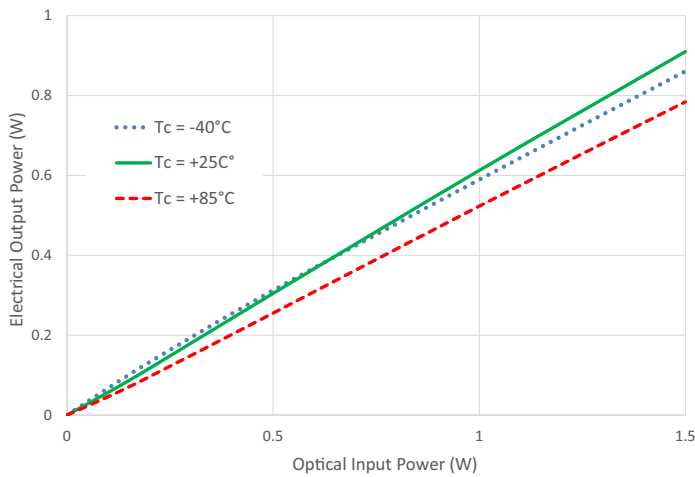
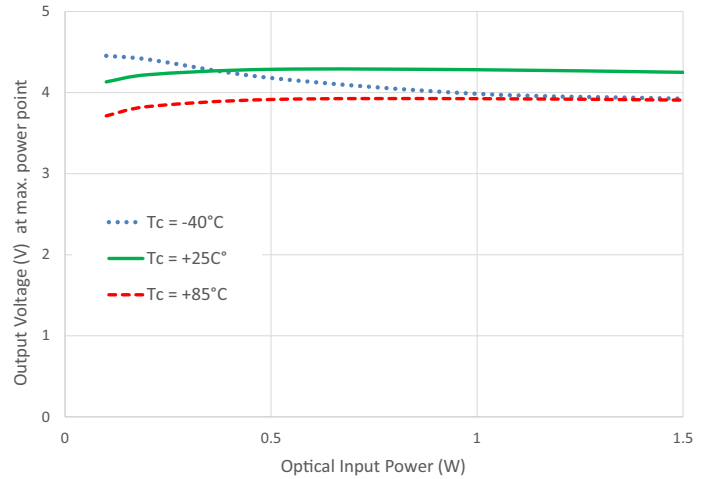

Figure 5: Typical Output Voltage vs. Optical Input Power of AFBR-POCx04L at Different Case Temperatures



AFBR-POCx06L

Optical power converters provide electrical output voltage levels for most 5 VDC applications.

Operating Characteristics

All specified parameters are valid for operations at 25°C case temperature and the use of a thermal interface material rated for a thermal contact resistance of less than 1.3 cm²K/W.

Parameter	Symbol	Min.	Typ. ^a	Max.	Units
Response Optical Spectrum Range ^b	λ_{IN}	800	808	850	nm
Maximum Electrical Output Power vs. Optical Input Power ^c	P_{out} at 0.1 $W_{opt IN}$	—	50	—	mW
	P_{out} at 0.2 $W_{opt IN}$	—	110	—	
	P_{out} at 0.5 $W_{opt IN}$	—	290	—	
	P_{out} at 1.0 $W_{opt IN}$	—	600	—	
	P_{out} at 1.5 $W_{opt IN}$	—	895	—	
Output Voltage at Maximum Electrical Output Power	V_{out} at 0.1 $W_{opt IN}$	—	6.3	—	V
	V_{out} at 0.2 $W_{opt IN}$	—	6.4	—	
	V_{out} at 0.5 $W_{opt IN}$	—	6.5	—	
	V_{out} at 1.0 $W_{opt IN}$	—	6.5	—	
	V_{out} at 1.5 $W_{opt IN}$	—	6.5	—	
Output Current at Maximum Electrical Output Power	I_{out} at 0.1 $W_{opt IN}$	—	8	—	mA
	I_{out} at 0.2 $W_{opt IN}$	—	17	—	
	I_{out} at 0.5 $W_{opt IN}$	—	45	—	
	I_{out} at 1.0 $W_{opt IN}$	—	93	—	
	I_{out} at 1.5 $W_{opt IN}$	—	138	—	

a. Typical values are average values measured at 25°C case temperature.

b. For operations over the entire temperature range, laser light with a wavelength not exceeding 830 nm is recommended.

c. Optical input power (808 nm, continuous) at the end of a 30m long, connectorized MM fiber measured with an optical power meter. Valid for multimode fibers with NA from 0.22 to 0.28.

Figure 6: Typical I-V Curves (at $T_C = +25^\circ\text{C}$) of AFBR-POCx06L at Different Optical Input Power

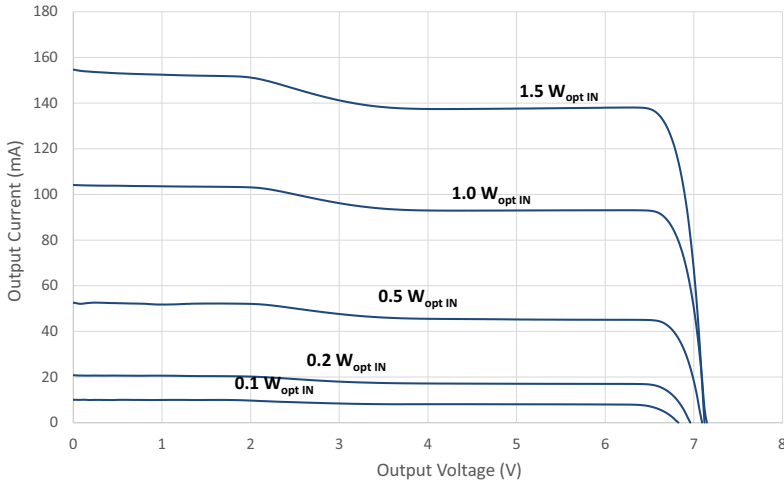

Figure 7: Typical Electrical Output Power vs. Optical Input Power of AFBR-POCx06L at Different Case Temperatures

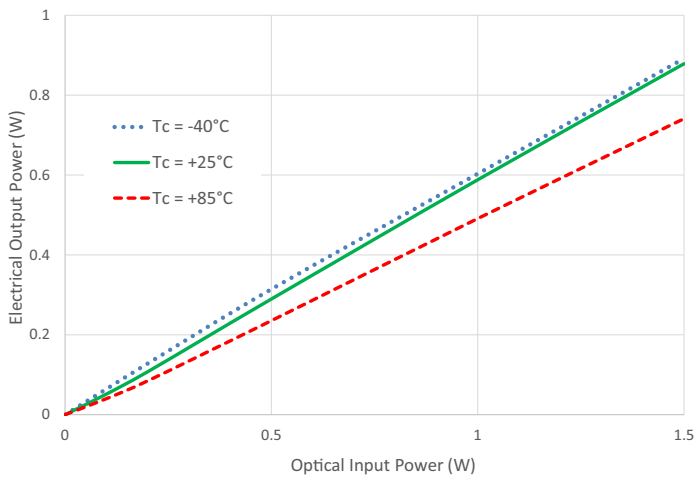
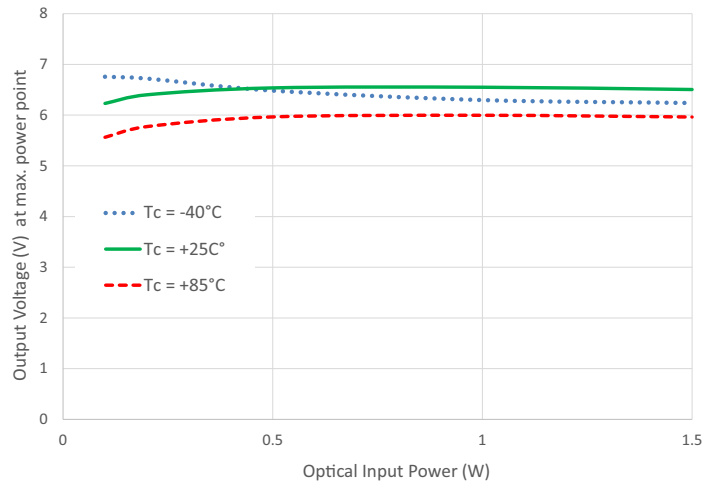

Figure 8: Typical Output Voltage vs. Optical Input Power of AFBR-POCx06L at Different Case Temperatures



Broadcom, the pulse logo, Connecting everything, Avago Technologies, Avago, and the A logo are among the trademarks of Broadcom and/or its affiliates in the United States, certain other countries and/or the EU.

Copyright © 2017–2019 Broadcom. All Rights Reserved.

The term “Broadcom” refers to Broadcom Inc. and/or its subsidiaries. For more information, please visit www.broadcom.com.

Broadcom reserves the right to make changes without further notice to any products or data herein to improve reliability, function, or design. Information furnished by Broadcom is believed to be accurate and reliable. However, Broadcom does not assume any liability arising out of the application or use of this information, nor the application or use of any product or circuit described herein, neither does it convey any license under its patent rights nor the rights of others.

