

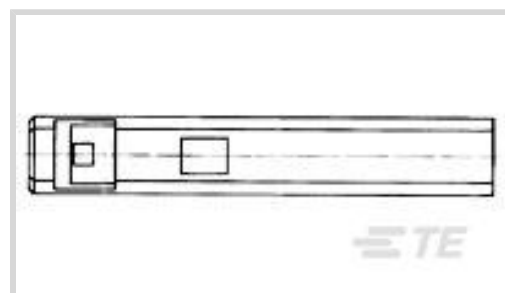

Connectors > PCB Connectors > Wire-to-Board Connectors > Wire-to-Board Connector Assemblies & Housings



Connector Product Type: **Housing**

Connector & Housing Type: **Receptacle**

Connector System: **Wire-to-Board**

Number of Positions: **6**

Centerline (Pitch): **2.54 mm [.1 in]**

Features

Product Type Features

Connector Product Type	Housing
Connector & Housing Type	Receptacle
Connector System	Wire-to-Board
Connector & Contact Terminates To	Wire & Cable

Configuration Features

Number of Positions	6
Number of Rows	1

Body Features

Primary Product Color	Black
-----------------------	-------

Contact Features

Contact Type	Socket
Contact Current Rating (Max)	3 A

Termination Features

Termination Method to Wire & Cable	Crimp
------------------------------------	-------

Mechanical Attachment

Strain Relief	Without
PCB Mount Retention	Without
Mating Retention	Without



Connector Mounting Type	Cable Mount (Free-Hanging)
-------------------------	----------------------------

Housing Features

Housing Entry Configuration	Both Ends Closed
Housing Material	PBT GV15
Centerline (Pitch)	2.54 mm[.1 in]

Dimensions

Row-to-Row Spacing	2.54 mm[.1 in]
--------------------	----------------

Usage Conditions

Operating Temperature Range	-65 – 105 °C[-85 – 221 °F]
-----------------------------	----------------------------

Operation/Application

Circuit Application	Signal
---------------------	--------

Industry Standards

UL Flammability Rating	UL 94V-0
------------------------	----------

Packaging Features

Packaging Quantity	1000
Packaging Method	Carton

Product Compliance

[For compliance documentation, visit the product page on TE.com>](#)

EU RoHS Directive 2011/65/EU	Compliant
EU ELV Directive 2000/53/EC	Compliant
China RoHS 2 Directive MIIT Order No 32, 2016	No Restricted Materials Above Threshold
EU REACH Regulation (EC) No. 1907/2006	Current ECHA Candidate List: JUNE 2023 (235) Candidate List Declared Against: JUNE 2023 (235) Does not contain REACH SVHC
Halogen Content	Not Low Halogen - contains Br or Cl > 900 ppm.
Solder Process Capability	Not applicable for solder process capability

Product Compliance Disclaimer

This information is provided based on reasonable inquiry of our suppliers and represents our current actual knowledge based on the information they provided. This information is subject to change. The part numbers that TE has identified as EU RoHS compliant have a maximum concentration of 0.1% by weight in homogenous materials for lead, hexavalent chromium, mercury, PBB, PBDE, DBP, BBP, DEHP, DIBP, and 0.01% for cadmium, or qualify for an exemption to these

limits as defined in the Annexes of Directive 2011/65/EU (RoHS2). Finished electrical and electronic equipment products will be CE marked as required by Directive 2011/65/EU. Components may not be CE marked. Additionally, the part numbers that TE has identified as EU ELV compliant have a maximum concentration of 0.1% by weight in homogenous materials for lead, hexavalent chromium, and mercury, and 0.01% for cadmium, or qualify for an exemption to these limits as defined in the Annexes of Directive 2000/53/EC (ELV). Regarding the REACH Regulation, the information TE provides on SVHC in articles for this part number is based on the latest European Chemicals Agency (ECHA) 'Guidance on requirements for substances in articles' posted at this URL: <https://echa.europa.eu/guidance-documents/guidance-on-reach>

Compatible Parts



TE Part # 5-87165-2
LOCKING CLIP ASSY .025 SQ LP



TE Part # 87190-1
LOCKING CLIP CONT ASSY .025 SQ



TE Part # 867052-2
LOCKING CLIP CONT ASSY .025 SQ



TE Part # 5-87124-2
LOCKING CLIP CONT ASSY .025 SQ



TE Part # 87124-1
LOCKING CLIP CONT ASSY .025 SQ



TE Part # 5-867052-1
LOCKING CLIP CONT ASSY .025 SQ



TE Part # 5-87191-2
LOCKING CLIP ASSY .025 SQ LP



TE Part # 867052-1
LOCKING CLIP CONT ASSY .025 SQ



TE Part # 87165-1
LOCKING CLIP ASSY .025 SQ LP



TE Part # 87165-2
LOCKING CLIP ASSY .025 SQ LP



TE Part # 87191-1
LOCKING CLIP ASSY .025 SQ LP

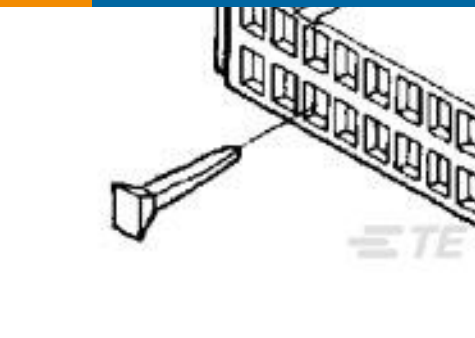

TE Part # 926329-1
KEYING PLUG

Also in the Series | AMPMODU LOCKING CLIP

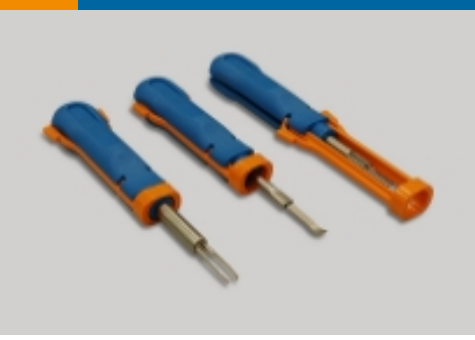

Insertion & Extraction Tools(3)



PCB Connector Keying(1)



Wire-to-Board Connector Assemblies & Housings(89)



Wire-to-Board Connector Contacts(7)

Customers Also Bought

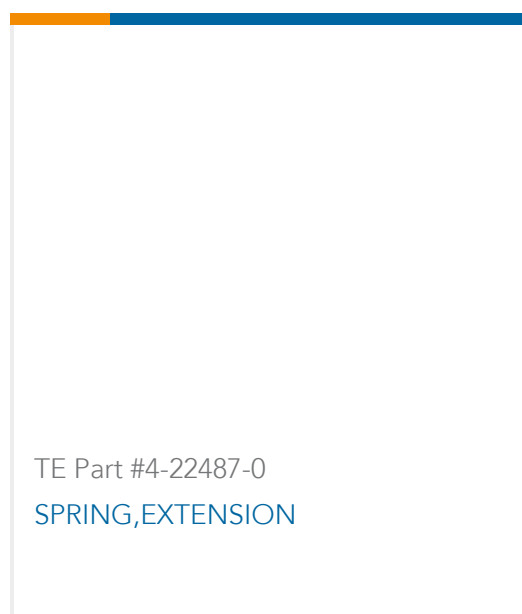
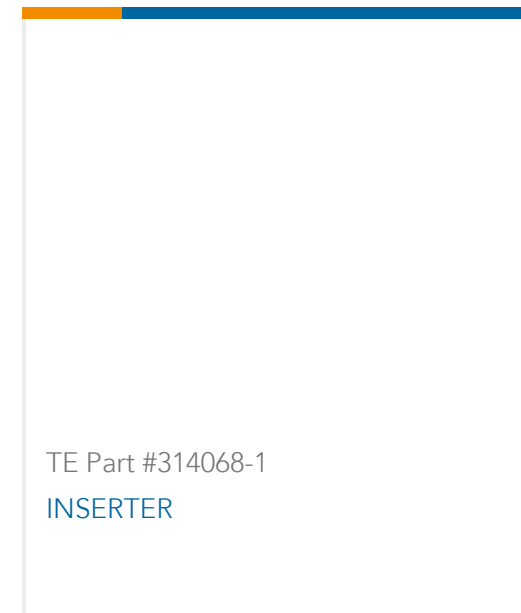
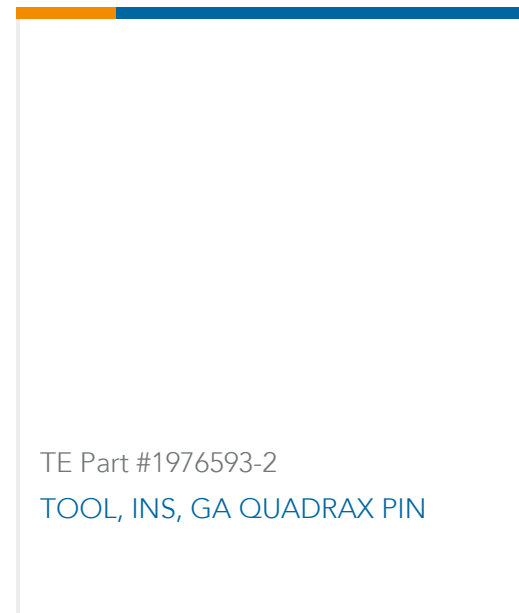
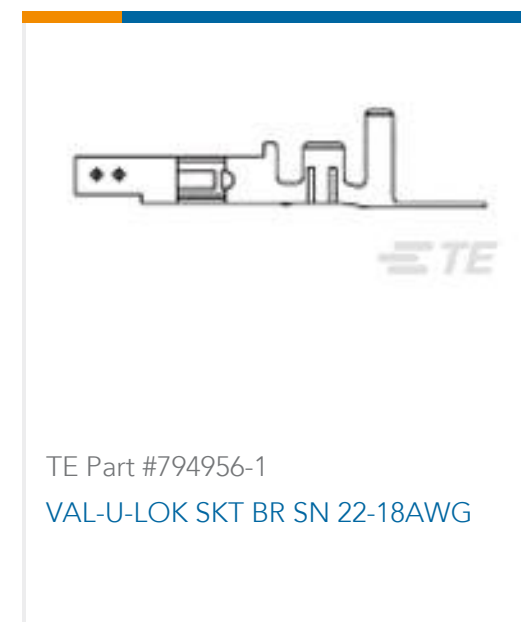
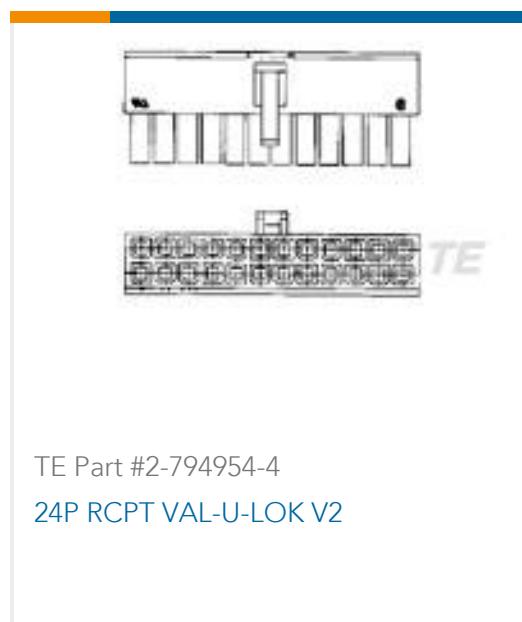

Documents

Product Drawings

LOCKING CLIP HSG

English

CAD Files

Customer View Model

[ENG_CVM_926657-6_E1.3d_igs.zip](#)

English

Customer View Model

[ENG_CVM_926657-6_E1.3d_stp.zip](#)

English

Customer View Model

[ENG_CVM_926657-6_E1.2d_dxf.zip](#)

English

3D PDF

English

By downloading the CAD file I accept and agree to the [Terms and Conditions](#) of use.

Agency Approvals



[UL Report](#)

English