

EF-27351-000
SHT 1.1

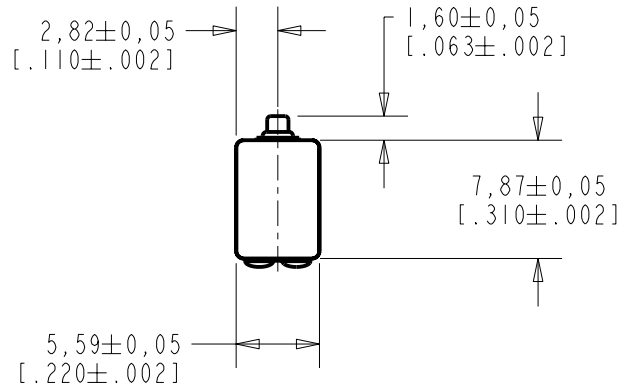

NOTES:

- 1 A POSITIVE GOING VOLTAGE AT TERMINAL 2, RELATIVE TO TERMINAL 1, CAUSES A DECREASE IN PRESSURE AT THE SOUND OUTLET.
- 2 LOCATED FROM TWO SURFACES FOR CUSTOMER CONVENIENCE. ONLY APPLICABLE FROM ONE SURFACE, NOT TO BE USED TOGETHER. HORIZONTAL LOCATION FOR TERMINAL CENTERED TO $\pm 0,17$ [.007].

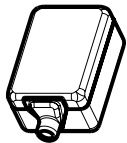
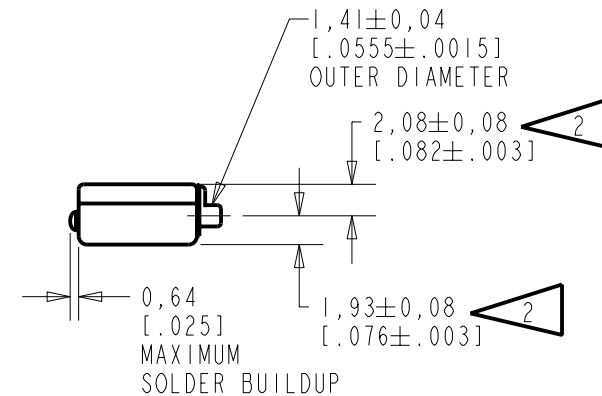
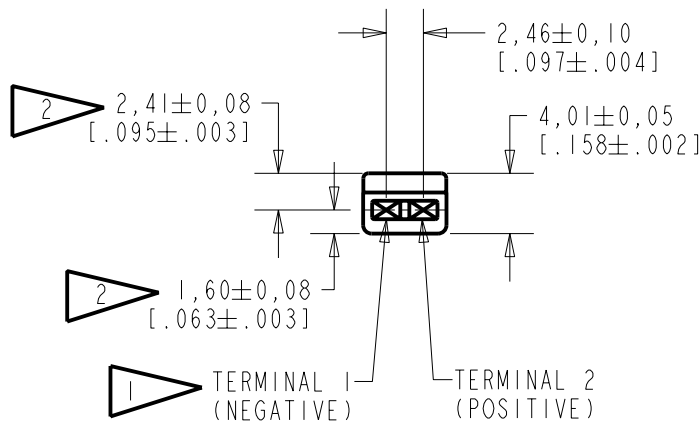

NOMINAL WEIGHT
.66 GRAM

DIMENSIONS IN MILLIMETERS [INCHES]

KNOWLES ELECTRONICS
ITASCA, ILLINOIS U.S.A.

Revision	C.O. #	Implementation Date	RELEASE LEVEL	REVISION
A	CI0103490	11-29-05	Released	A
SCALE: 2:1			DR. BY: MMM	DATE: 11-29-05
DO NOT SCALE DRAWING			CK. BY: GJP	DATE: 11-29-05
TITLE: RECEIVER		EF-27351-000	APP. BY: GJP	DATE: 11-29-05
OUTLINE DRAWING		SHT 1.1		

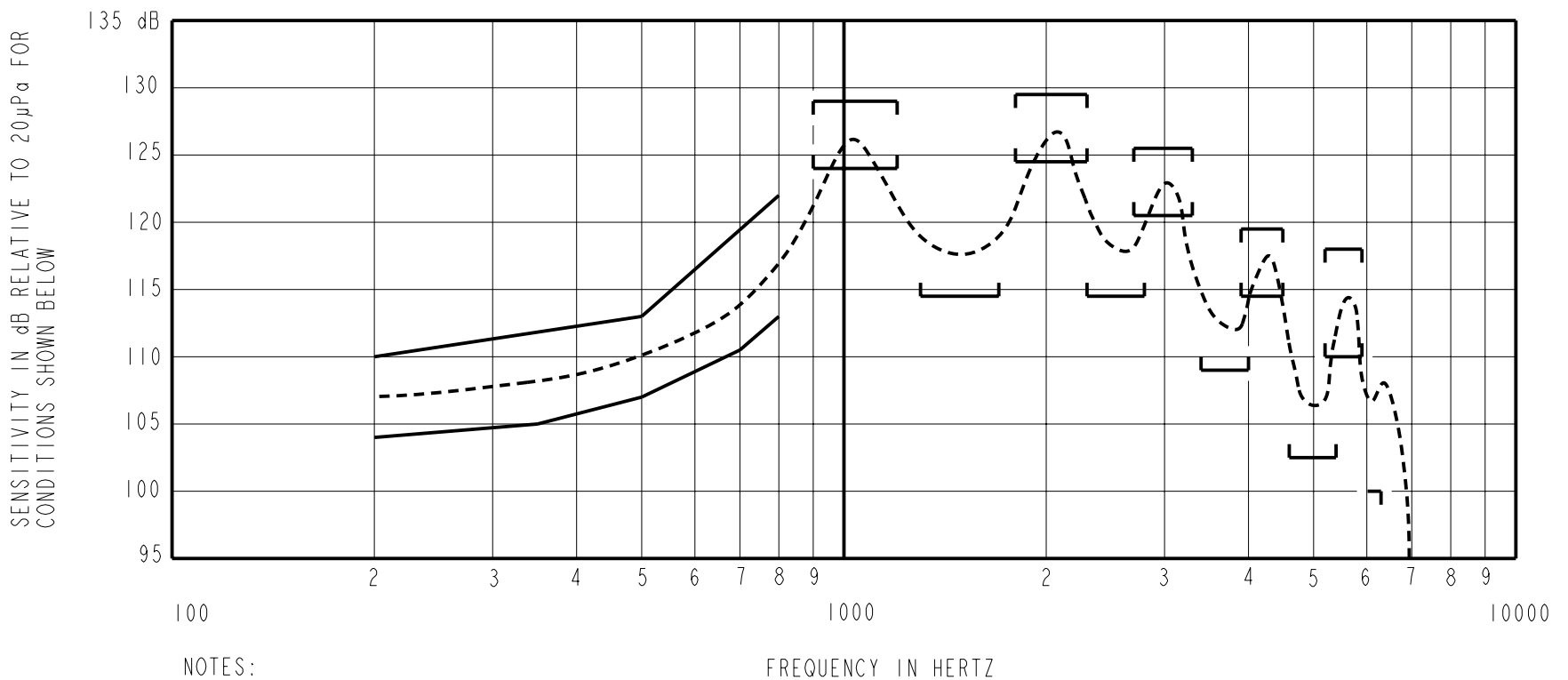

NOTES:

FREQUENCY IN HERTZ

1. MEASUREMENTS MADE USING 8mm (.315") X 1mm (.039") ID + 28mm (1.10") X 1.5mm (.059") ID EAR HOOK SIMULATOR INTO 25mm (.984") OF 2mm (.079") ID TUBE + 18mm (.709") OF 3mm (.118") ID TUBE + 2cm³ CAVITY (AS IEC126). (T-2607 AND B & K DB0138).

2. SENSITIVITY

FREQUENCY	MIN.	MAX.
200	104.0	110.0
350	105.0	---
500	107.0	113.0
700	110.5	---
800	113.0	122.0
900-1200	124.0	129.0
1300-1700	114.5	---
1800-2300	124.5	129.5
2300-2800	114.5	---
2700-3300	120.5	125.5
3400-4000	109.0	---
3900-4500	114.5	119.5
4600-5400	102.5	---
5200-5900	110.0	118.0
<6300	100.0	---

- RESPONSE, IMPEDANCE, AND DISTORTION MEASUREMENTS MADE USING THE ELECTRICAL TEST CONDITIONS SHOWN BELOW.
- ELECTRICAL SOURCE IMPEDANCE MUST BE GREATER THAN 20 TIMES 1KHz IMPEDANCE FOR TEST CONDITIONS SHOWN BELOW.
- INDIVIDUAL SPECIFICATIONS.

PORT LOCATION	IMPEDANCE OHMS ±15%		DCR @20°C OHMS ±10%	DISTORTION		ELECTRICAL TEST CONDITIONS (CONSTANT CURRENT)	
	1KHz	500Hz		MAX. %	FREQ Hz	AC mA RMS	DC mA
12S	140	57	21	10	500	2.45	0.00

Revision	C.O. #	Implementation Date	RELEASE LEVEL	REVISION
A	C10103490	11-29-05	Released	A

KNOWLES ELECTRONICS
ITASCA, ILLINOIS U.S.A.

WHEN TEST LIMITS ARE USED TO ESTABLISH INCOMING INSPECTION ACCEPTANCE/REJECTION CRITERIA, CORRELATION OF TEST EQUIPMENT WITH KNOWLES IS ALSO REQUIRED FOR ELIMINATION OF EQUIPMENT AND TEST METHOD VARIATION

TITLE: **RECEIVER**
PERFORMANCE SPECIFICATION

EF-27351-000
SHT 2.1

DR. BY	DATE
MMM	11-29-05
CK. BY	DATE
GJP	11-29-05
APP. BY	DATE
GJP	11-29-05