

LC020 Single-Output Series Power Module: 18 Vdc to 36 Vdc Inputs; 20 W



The LC020 Single-Output Series Power Modules use advanced, surface-mount technology and deliver high-quality, compact, dc-dc conversion at an economical price.

Applications

- n Distributed Power Architectures
- n Telecommunications
- n Data Networking
- n Wireless

Description

The LC020 Single-Output Series Power Modules are low-profile, dc-dc converters that operate over an input voltage range of 18 Vdc to 36 Vdc and provide a precisely regulated 3.3 V, 5 V, 12 V, or 15 V output. The output is isolated from the input, allowing versatile polarity configurations and grounding connections. The modules have a maximum power rating of 20 W at a typical full-load efficiency of up to 82%.

The power module features remote on/off and output voltage adjustment of 90% to 110% of the nominal output voltage. Built-in filtering for both input and output minimizes the need for external filtering.

* *UL* is a registered trademark of Underwriters Laboratories, Inc.

† *CSA* is a registered trademark of Canadian Standards Association.

‡ *VDE* is a trademark of Verband Deutscher Elektrotechniker e.V.

Features

- n Low profile: 9.9 mm (0.390 in.) with standoffs, 9.53 mm (0.375 in.) with standoffs recessed
- n Wide input voltage range: 18 Vdc to 36 Vdc
- n Input-to-output isolation: 850 V
- n Operating ambient temperature range: -40 °C to +100 °C
- n Output overcurrent protection, unlimited duration
- n Remote on/off logic
- n Output voltage adjust: 90% to 110% of $V_{O, nom}$
- n *UL** 60950 Recognized, *CSA*† C22.2 No. 60950-00 Certified, *VDE*‡ 0805 (IEC60950) Licensed
- n Within FCC Class A radiated limits

Options

- n Choice of remote on/off logic configuration
- n Case ground pin
- n Synchronization
- n Short pin: 2.79 mm ± 0.25 mm (0.110 in. ± 0.010 in.)

Absolute Maximum Ratings

Stresses in excess of the absolute maximum ratings can cause permanent damage to the device. These are absolute stress ratings only. Functional operation of the device is not implied at these or any other conditions in excess of those given in the operations sections of the data sheet. Exposure to absolute maximum ratings for extended periods can adversely affect device reliability.

Parameter	Symbol	Min	Max	Unit
Input Voltage				
Continuous	V_I	0	40	Vdc
100 ms Transient	$V_{I, trans}$	0	50	V
Operating Case Temperature (See Thermal considerations section.)	T_C	-40	100	°C
Storage Temperature	T_{stg}	-40	120	°C
I/O Isolation Voltage	—	—	850	Vdc

Electrical Specifications

Unless otherwise indicated, specifications apply over all operating input voltage, resistive load, and temperature conditions.

Table 1. Input Specifications

Parameter	Symbol	Min	Typ	Max	Unit
Operating Input Voltage	V_I	18	28	36	Vdc
Maximum Input Current ($V_I = 0$ V to $V_{I, max}$; $I_O = I_{O, max}$; see Figures 1—4.)	$I_{I, max}$	—	—	2.2	A
Inrush Transient	i^2t	—	—	0.1	A ² s
Input Reflected-ripple Current (50 Hz to 20 MHz; 12 μ H source impedance, $T_C = 25$ °C; see Figure 16 and Design Considerations section.)	I_I	—	3	—	mAp-p
Input Ripple Rejection (100 Hz—120 Hz)	—	—	60	—	dB

Fusing Considerations

CAUTION: This power module is not internally fused. An input line fuse must always be used.

This encapsulated power module can be used in a wide variety of applications, ranging from simple stand-alone operation to an integrated part of a sophisticated power architecture. To preserve maximum flexibility, internal fusing is not included; however, to achieve maximum safety and system protection, always use an input line fuse. The safety agencies require a normal-blow, dc fuse with a maximum rating of 5 A (see Safety Considerations section). Based on the information provided in this data sheet on inrush energy and maximum dc input current, the same type of fuse with a lower rating can be used. Refer to the fuse manufacturer's data for further information.

Electrical Specifications (continued)

Table 2. Output Specifications

Parameter	Device	Symbol	Min	Typ	Max	Unit
Output Voltage Set Point ($V_i = 28\text{ V}$; $I_o = I_{o, \text{max}}$; $T_c = 25\text{ }^\circ\text{C}$)	LC020F	$V_{o, \text{set}}$	3.25	—	3.35	Vdc
	LC020A	$V_{o, \text{set}}$	4.92	—	5.08	Vdc
	LC020B	$V_{o, \text{set}}$	11.81	—	12.19	Vdc
	LC020C	$V_{o, \text{set}}$	14.76	—	15.24	Vdc
Output Voltage (Over all line, load, and temperature conditions until end of life; see Figure 18.)	LC020F	V_o	3.17	—	3.43	Vdc
	LC020A	V_o	4.80	—	5.20	Vdc
	LC020B	V_o	11.52	—	12.48	Vdc
	LC020C	V_o	14.40	—	15.60	Vdc
Output Regulation: Line ($V_i = 18\text{ V}$ to 36 V) Load ($I_o = I_{o, \text{min}}$ to $I_{o, \text{max}}$) Temperature ($T_c = -40\text{ }^\circ\text{C}$ to $+100\text{ }^\circ\text{C}$)	All	—	—	0.01	0.1	% V_o
	All	—	—	0.05	0.2	% V_o
	All	—	—	0.5	1.0	% V_o
Output Ripple and Noise Voltage (See Figure 17.) RMS Peak-to-peak (5 Hz to 20 MHz)	LC020A, F	—	—	—	30	mVrms
	LC020B, C	—	—	—	50	mVrms
	LC020A, F	—	—	20	100	mVp-p
	LC020B, C	—	—	50	150	mVp-p
Output Current (At $I_o < I_{o, \text{min}}$, the modules may exceed output ripple specifications.)	LC020A, F	I_o	0.4	—	4.0	A
	LC020B	I_o	0.17	—	1.67	A
	LC020C	I_o	0.13	—	1.33	A
Output Current-limit Inception ($V_o = 90\% \times V_{o, \text{set}}$) (See Figures 5 — 8.)	All	I_o	103	—	150	% $I_{o, \text{max}}$
Output Short-circuit Current ($V_o = 250\text{ mV}$)	All	I_o	—	135	200	% $I_{o, \text{max}}$
Efficiency (V_i, nom ; $I_o = I_{o, \text{max}}$; $T_c = 25\text{ }^\circ\text{C}$; see Figures 9 — 12, 18.)	LC020F	η	73	76	—	%
	LC020A	η	76	79	—	%
	LC020B	η	79	82	—	%
	LC020C	η	79	82	—	%
Switching Frequency	All	—	—	256	—	kHz
Dynamic Response ($\Delta I_o / \Delta t = 1\text{ A} / 10\text{ } \mu\text{s}$, $V_i = V_i, \text{nom}$, $T_A = 25\text{ }^\circ\text{C}$; see Figures 13, 14.): Load Change from $I_o = 50\%$ to 75% of $I_{o, \text{max}}$: Peak Deviation Settling Time ($V_o < 10\%$ peak deviation) Load Change from $I_o = 50\%$ to 25% of $I_{o, \text{max}}$: Peak Deviation Settling Time ($V_o < 10\%$ peak deviation)	All	—	—	1	—	% $V_{o, \text{set}}$
	All	—	—	0.5	—	ms
	All	—	—	1	—	% $V_{o, \text{set}}$
	All	—	—	0.5	—	ms

Electrical Specifications (continued)

Table 3. Isolation Specifications

Parameter	Min	Typ	Max	Unit
Isolation Capacitance	—	0.002	—	μF
Isolation Resistance	10	—	—	MΩ

General Specifications

Parameter	Min	Typ	Max	Unit
Calculated MTBF ($I_o = 80\%$ of $I_{o, max}$; $T_c = 40\text{ °C}$)	5,800,000			hours
Weight	—	—	54 (1.9)	g (oz.)

Feature Specifications

Unless otherwise indicated, specifications apply over all operating input voltage, resistive load, and temperature conditions. .

Parameter	Device	Symbol	Min	Typ	Max	Unit
Remote On/Off ($V_i = 0\text{ V}$ to 36 V ; open collector or equivalent compatible; signal referenced to $V_i(-)$ terminal. See Figure 19 and Feature Descriptions.): LC020xx Positive Logic Logic Low—Module Off Logic High—Module On LC020xx1 Negative Logic Logic Low—Module On Logic High—Module Off Module Specifications: On/Off Current—Logic Low On/Off Voltage: Logic Low Logic High ($I_{on/off} = 0$) Open Collector Switch Specifications: Leakage Current During Logic High ($V_{on/off} = 6\text{ V}$) Output Low Voltage During Logic Low ($I_{on/off} = 1\text{ mA}$) Turn-on Time ($I_o = 80\%$ of $I_{o, max}$; $T_c = 40\text{ °C}$ V_o within $\pm 1\%$ of steady state) Output Voltage Overshoot (See Figure 15)	All	$I_{on/off}$	—	—	1.0	mA
	All	$V_{on/off}$	-0.7	—	1.2	V
	All	$V_{on/off}$	—	—	6	V
	All	$I_{on/off}$	—	—	50	μA
	All	$V_{on/off}$	—	—	1.2	V
	All	—	—	—	2	ms
	All	—	—	0	5.0	%
Output Voltage Set-Point Adjustment Range	All	—	90	—	110	% $V_{O, nom}$
Output Overvoltage Protection (clamp)	LC020F	$V_{O, clamp}$	3.9	—	5.0	V
	LC020A	$V_{O, clamp}$	5.6	—	7.0	V
	LC020B	$V_{O, clamp}$	13.2	—	16.5	V
	LC020C	$V_{O, clamp}$	16.5	—	19.0	V

Characteristics Curves

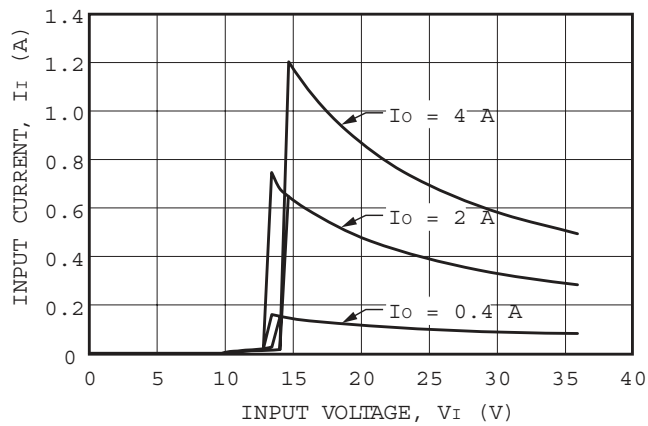

1-0333

Figure 1. LC020F Typical Input Characteristics,
 $T_A = 25\text{ }^\circ\text{C}$

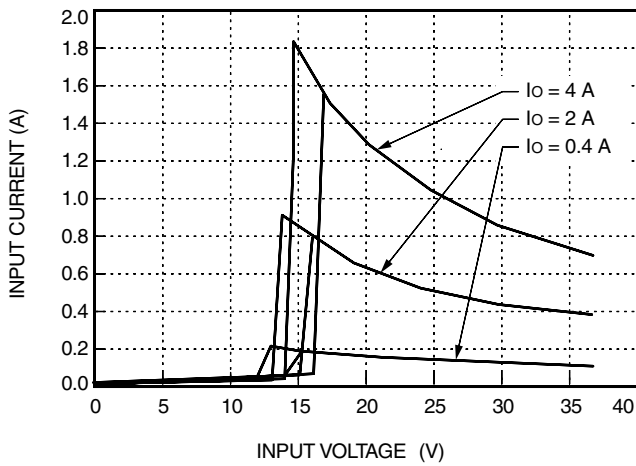

8-1374a

Figure 2. LC020A Typical Input Characteristics,
 $T_A = 25\text{ }^\circ\text{C}$

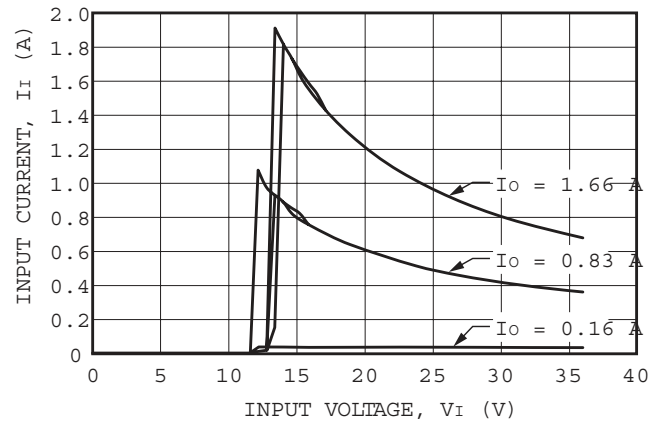

1-0335

Figure 3. LC020B Typical Input Characteristics,
 $T_A = 25\text{ }^\circ\text{C}$

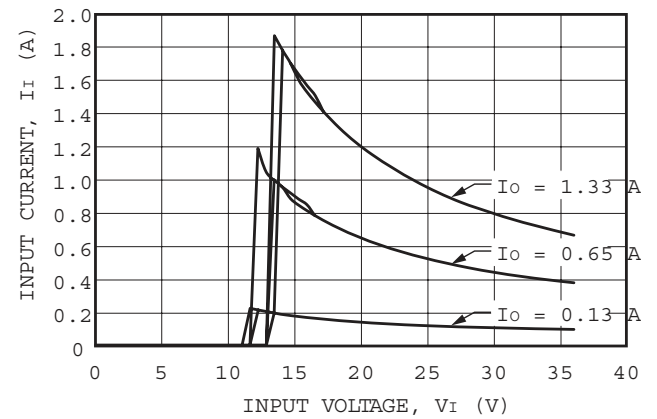

1-0334

Figure 4. LC020C Typical Input Characteristics,
 $T_A = 25\text{ }^\circ\text{C}$

Characteristics Curves (continued)

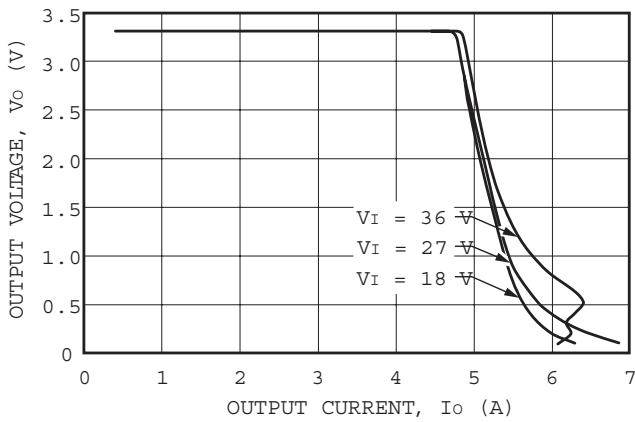

1-0342

Figure 5. LC020F Typical Output Characteristics,
 $T_A = 25\text{ }^\circ\text{C}$

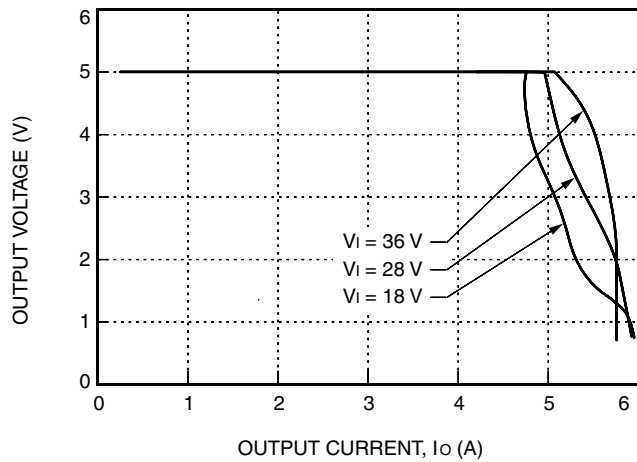

8-1373

Figure 6. LC020A Typical Output Characteristics,
 $T_A = 25\text{ }^\circ\text{C}$

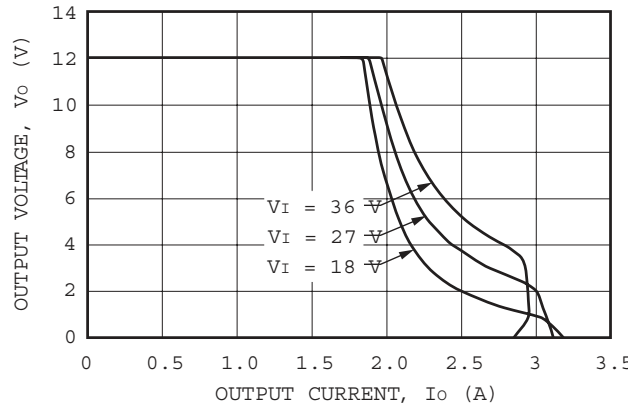

1-0344

Figure 7. LC020B Typical Output Characteristics,
 $T_A = 25\text{ }^\circ\text{C}$

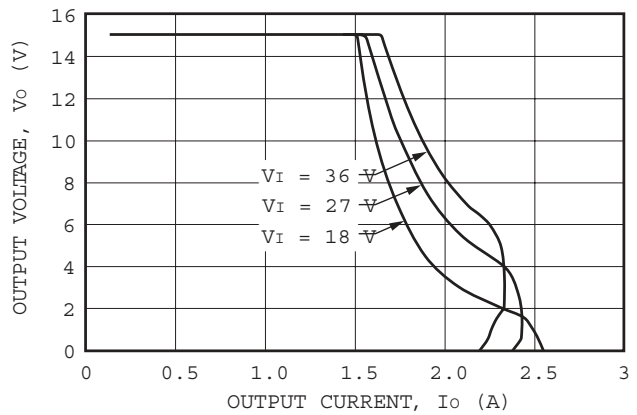

1-0343

Figure 8. LC020C Typical Output Characteristics,
 $T_A = 25\text{ }^\circ\text{C}$

Characteristics Curves (continued)

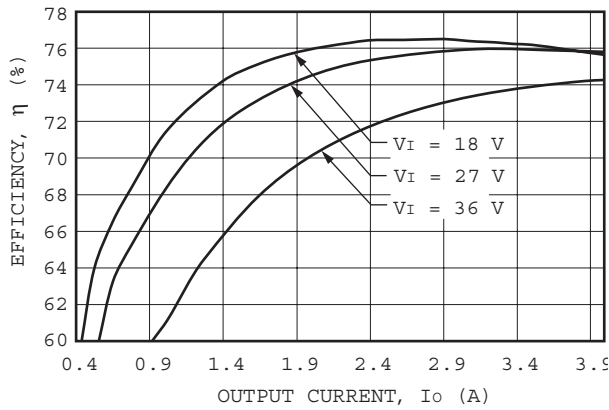

1-0340

Figure 9. LC020F Typical Converter Efficiency vs. Output Current, $T_A = 25\text{ }^\circ\text{C}$

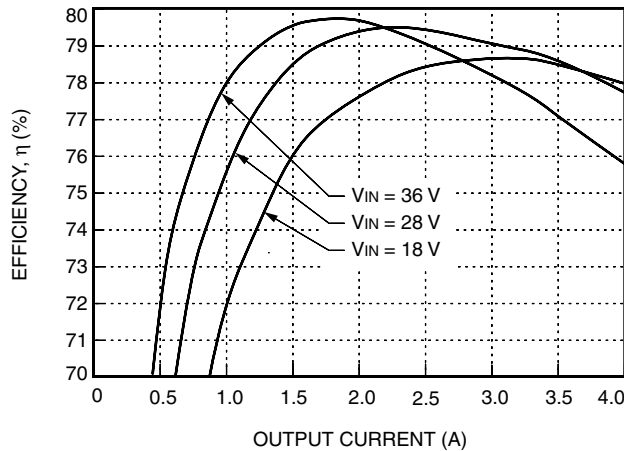

8-1372

Figure 10. LC020A Typical Converter Efficiency vs. Output Current, $T_A = 25\text{ }^\circ\text{C}$

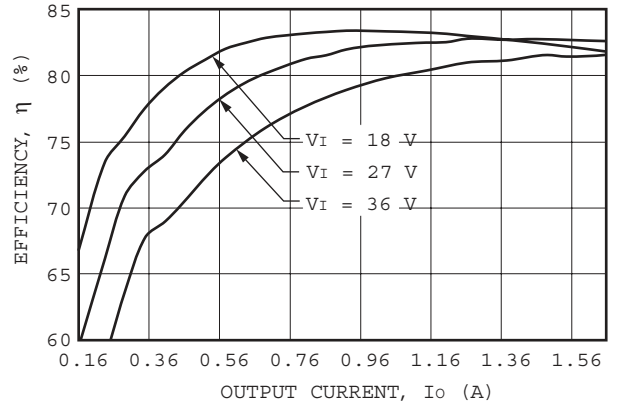

1-0339

Figure 11. LC020B Typical Converter Efficiency vs. Output Current, $T_A = 25\text{ }^\circ\text{C}$

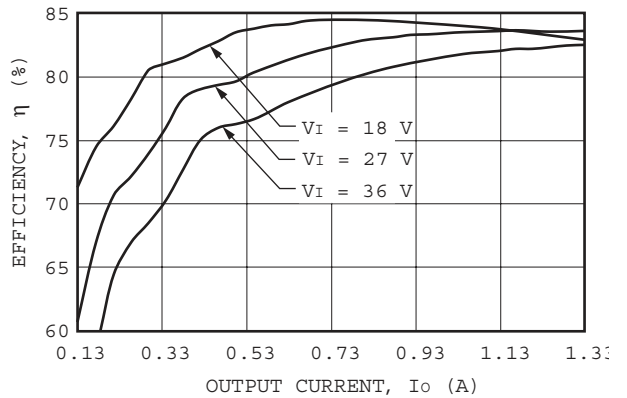

1-0341

Figure 12. LC020C Typical Converter Efficiency vs. Output Current, $T_A = 25\text{ }^\circ\text{C}$

Characteristics Curves (continued)

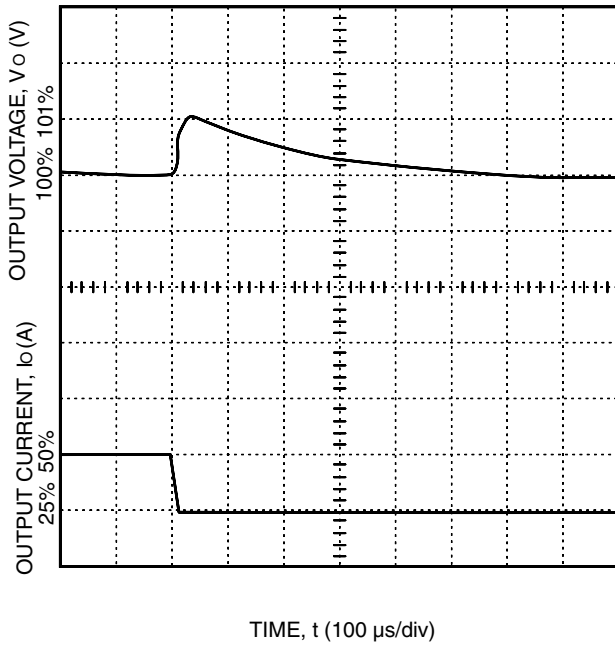

8-1261

Figure 13.LC020A,B,C,F Typical Output Voltage for a Step Load Change from 50% to 25%

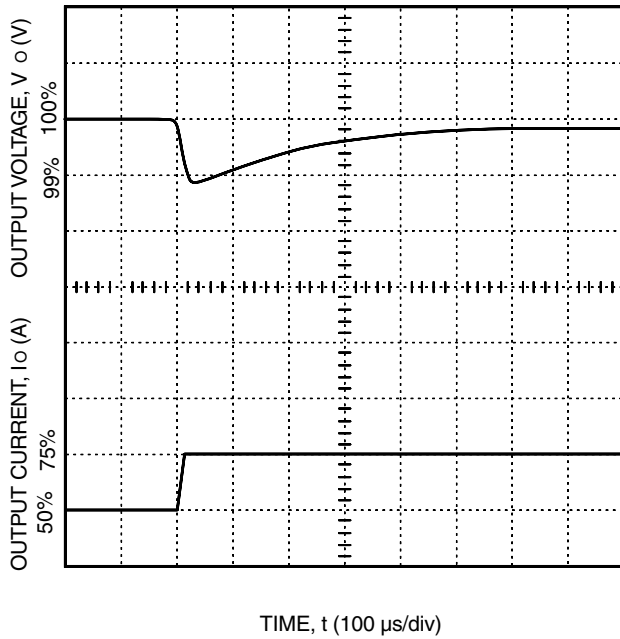

8-1262

Figure 14.LC020A,B,,C,F Typical Output Voltage for a Step Load Change from 50% to 75%

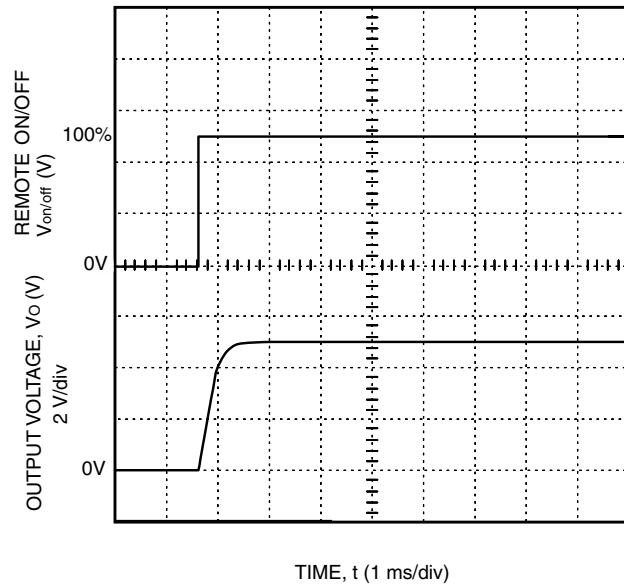

8-1263

Figure 15.LC020A,B,C,F Typical Output Voltage Start-up When Signal Applied to Remote On/Off

Test Configurations

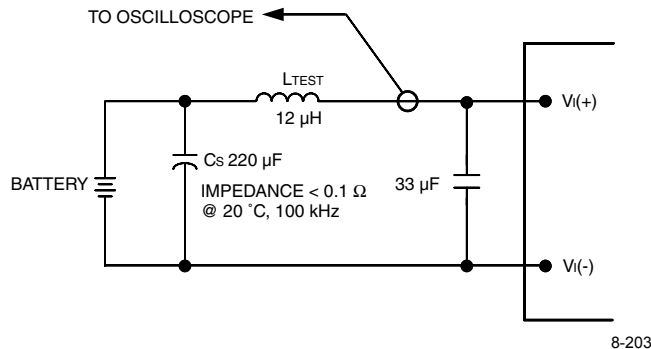

Note: Input reflected-ripple current is measured with a simulated source impedance of 12 μH . Capacitor Cs offsets possible battery impedance. Current is measured at the input of the module.

Figure 16. Input Reflected-Ripple Test Setup

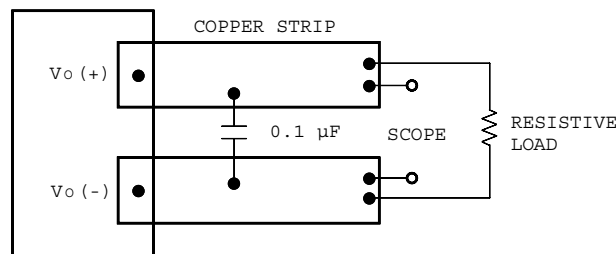

Note: Use a 0.1 μF ceramic capacitor. Scope measurement should be made using a BNC socket. Position the load between 50 mm (2 in.) and 75 mm (3 in.) from the module.

Figure 17. Peak-to-Peak Output Noise Measurement Test Setup

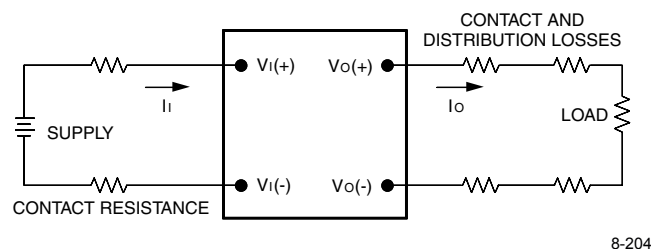

Note: All measurements are taken at the module terminals. When socketing, place Kelvin connections at module terminals to avoid measurement errors due to socket contact resistance.

$$\eta = \left(\frac{[V_{O(+)} - V_{O(-)}] I_O}{[V_{I(+)} - V_{I(-)}] I_I} \right) \times 100$$

Figure 18. Output Voltage and Efficiency Measurement Test Setup

Design Considerations

Grounding Considerations

For standard units, the case is connected internally to $V_{I(-)}$. For units with the case ground pin option, the case is not connected internally allowing the user flexibility in grounding.

Input Source Impedance

The power module should be connected to a low ac-impedance input source. Highly inductive source impedances can affect the stability of the power module. For the test configuration in Figure 16, a 33 μF electrolytic capacitor (ESR < 0.7 $\frac{3}{4}$ at 100 kHz) mounted close to the power module helps ensure stability of the unit. For other highly inductive source impedances, consult the factory for further application guidelines.

Safety Considerations

For safety-agency approval of the system in which the power module is used, the power module must be installed in compliance with the spacing and separation requirements of the end-use safety agency standard, i.e., UL-60950, CSA 22.2-950 No. 60950-00, and VDE 0805 (IEC60950).

For the converter output to be considered meeting the requirements of safety extra low voltage (SELV), the input must meet SELV requirements.

If the input meets extra low voltage (ELV) requirements, then the converter's output is considered ELV.

The input to these units are to be provided with a maximum 5 A normal-blow fuse in the ungrounded lead.

Feature Descriptions

Overcurrent Protection

To provide protection in a fault (output overload) condition, the unit is equipped with internal current-limiting circuitry and can endure current limiting for an unlimited duration. At the point of current-limit inception, the unit shifts from voltage control to current control. If the output voltage is pulled very low during a severe fault, the current-limit circuit can exhibit either foldback or tailout characteristics (output-current decrease or increase). The unit operates normally once the output current is brought back into its specified range.

Feature Descriptions (continued)

Remote On/Off

Two remote on/off options are available. Positive logic remote on/off turns the module on during a logic high voltage on the REMOTE ON/OFF pin, and off during a logic low. Negative logic device code suffix of "1," remote on/off turns the module off during a logic high and on during a logic low.

To turn the power module on and off, the user must supply a switch to control the voltage between the on/off terminal and the $V_I(-)$ terminal ($V_{on/off}$). The switch can be an open collector or equivalent (see Figure 19). A logic low is $V_{on/off} = -0.7V$ to $1.2 V$. The maximum $I_{on/off}$ during a logic low is 1 mA. The switch should maintain a logic low voltage while sinking 1 mA.

During a logic high, the maximum $V_{on/off}$ generated by the power module is 6 V. The maximum allowable leakage current of the switch at $V_{on/off} = 6 V$ is $50 \mu A$.

The module has internal capacitance to reduce noise at the ON/OFF pin. Additional capacitance is not generally needed and may degrade the start-up characteristics of the module.

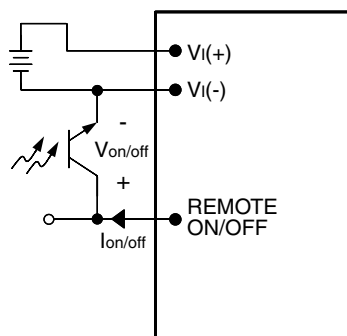

8-758

Figure 19. Remote On/Off Implementation

Output Voltage Adjustment

Output voltage trim allows the user to increase or decrease the output voltage set point of a module. This is accomplished by connecting an external resistor between the TRIM pin and either the $V_O(+)$ or $V_O(-)$ pins. With an external resistor between the TRIM and $V_O(+)$ pins ($R_{adj-down}$), the output voltage set point ($V_{O,adj}$) decreases. With an external resistor between the TRIM pin and $V_O(-)$ pin (R_{adj-up}), $V_{O,adj}$ increases.

The following equations determine the required external resistor value to obtain an output voltage change of $\Delta\%$:

$$R_{adj-down} = \left[\frac{c[d \cdot (100 - \Delta\%) - 100]}{\Delta\%} - b \right] k\Omega$$

$$R_{adj-up} = \left[\frac{100a}{d \cdot \Delta\%} - b \right] k\Omega$$

Device	a	b	c	d	-5% V_O $R_{adj-down}$	+5% V_O R_{adj-up}
LC020F	14.0	51.10	5.19	2.70	110.9 k Ω	52.8 k Ω
LC020A	4.02	16.90	2.01	2.0	19.3 k Ω	23.3 k Ω
LC020B	15.40	15.40	1.58	9.80	246.5 k Ω	16.0 k Ω
LC020C	21.50	16.90	1.76	12.24	356.3 k Ω	18.2 k Ω

Feature Descriptions (continued)

Output Voltage Adjustment (continued)

The adjusted output voltage cannot exceed 110% of the nominal output voltage between the $V_O(+)$ and $V_O(-)$ terminal.

The modules have a fixed current-limit set point. Therefore, as the output voltage is adjusted down, the available output power is reduced. In addition, the minimum output current is a function of the output voltage. As the output voltage is adjusted down, the minimum required output current can increase.

Output Overvoltage Protection

The output overvoltage clamp consists of control circuitry, independent of the primary regulation loop, that monitors the voltage on the output terminals. The control loop of the protection circuit has a higher voltage set point than the primary loop (see Feature Specifications table).

In a fault condition, the overvoltage clamp ensures that the output voltage does not exceed $V_{O, \text{clamp, max}}$. This provides a redundant voltage control that reduces the risk of output overvoltage.

Synchronization (Optional)

The unit is capable of external synchronization from an independent time base with a switching rate of 256 kHz. The amplitude of the synchronizing pulse train is TTL compatible and the duty cycle ranges between 40% and 60%. Synchronization is referenced to $V_{IN}(+)$.

Thermal Considerations

Introduction

The LC020 power module operates in a variety of thermal environments; however, sufficient cooling should be provided to help ensure reliable operation of the unit. Heat-dissipating components inside the unit are thermally coupled to the case. Heat is removed by conduction, convection, and radiation to the surrounding environment. Proper cooling can be verified by measuring the case temperature. Peak case temperature (T_c) occurs at the position indicated in Figure 20.

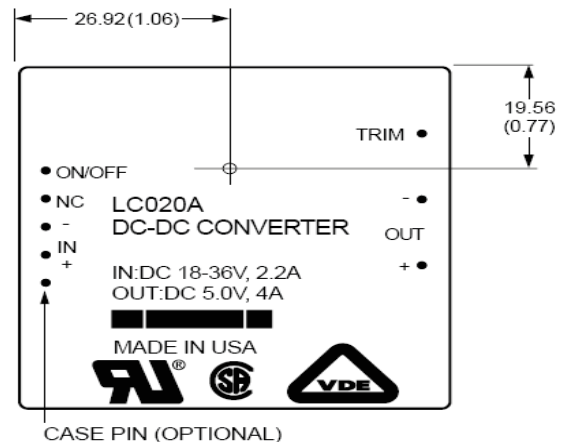

8-1265

Note: Dimensions are in millimeters and (inches).

Figure 20. Case Temperature Measurement Location

Note that the view in Figure 20 is of the metal surface of the module—the pin locations shown are for reference. The temperature at this location should not exceed 100 °C. The output power of the module should not exceed the rated power for the module as listed in the Ordering Information table.

Heat Transfer Without Heat Sinks

Increasing airflow over the module enhances the heat transfer via convection. Figure 21 shows the maximum power that can be dissipated by the module without exceeding the maximum case temperature versus local ambient temperature (T_A) for natural convection through 3.0 ms^{-1} (600 ft./min.).

Note that the natural convection condition was measured at 0.05 ms^{-1} (10 ft./min.) to 0.1 ms^{-1} (20 ft./min.); however, systems in which these power modules may be used typically generate natural convection airflow rates of 0.3 ms^{-1} (60 ft./min.) due to other heat dissipating components in the system. Use of Figure 21 is shown in the following example.

Example

What is the minimum airflow necessary for an LC020A operating at high line, an output current of 2.0 A, and a maximum ambient temperature of 83 °C?

Thermal Considerations (continued)

Heat Transfer Without Heat Sinks (continued)

Solution:

Given: $V_I = 36\text{ V}$, $I_O = 2.0\text{ A}$, $T_A = 83\text{ }^\circ\text{C}$
Determine P_D (Figure 23): $P_D = 2.9\text{ W}$
Determine Airflow (Figure 21): $v = 1.0\text{ ms}^{-1}$
(200 ft./min.)

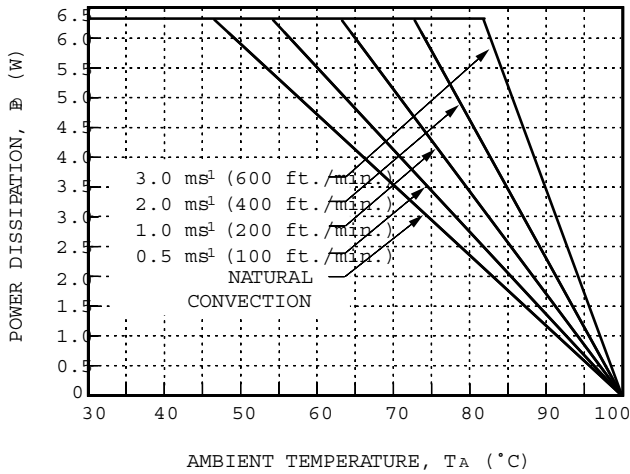

8-1264

Figure 21. Forced Convection Power Derating with No Heat Sink; Either Orientation

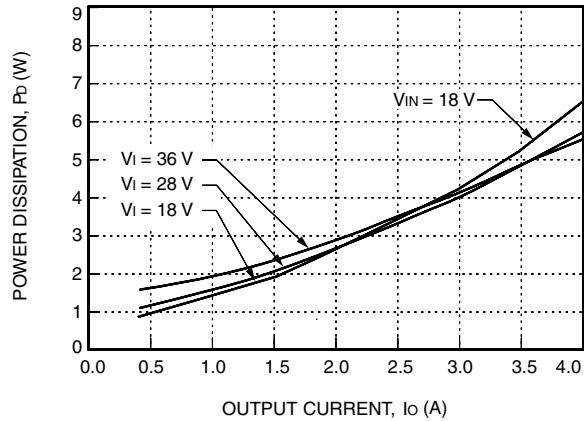

8-1371

Figure 23. LC020A Power Dissipation vs. Output Current, $T_A = 25\text{ }^\circ\text{C}$

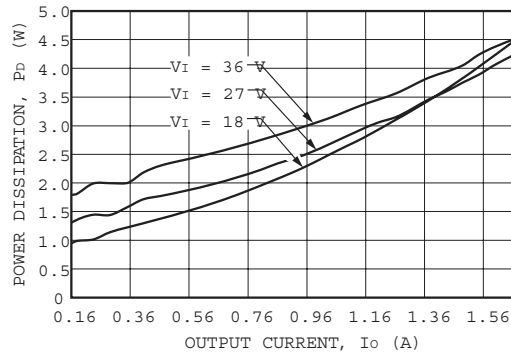

1-0338

Figure 24. LC020B Power Dissipation vs. Output Current, $T_A = 25\text{ }^\circ\text{C}$

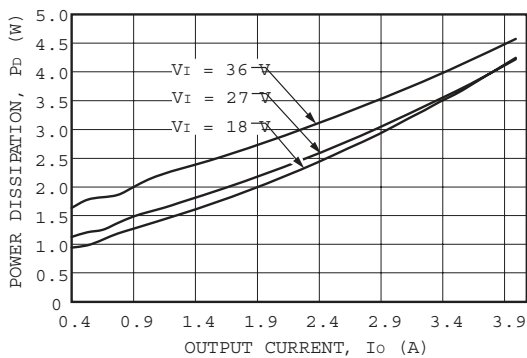

1-0337

Figure 22. LC020F Power Dissipation vs. Output Current, $T_A = 25\text{ }^\circ\text{C}$

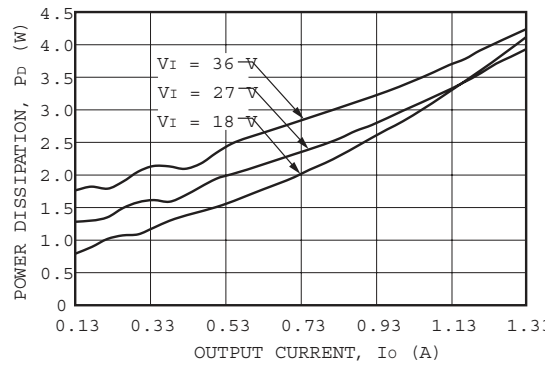

1-0336

Figure 25. LC020C Power Dissipation vs. Output Current, $T_A = 25\text{ }^\circ\text{C}$

Thermal Considerations (continued)

Module Derating

The derating curves in Figure 21 were obtained from measurements obtained in an experimental apparatus shown in Figure 26. Note that the module and the printed-wiring board (PWB) that it is mounted on are vertically oriented. The passage has a rectangular cross section.

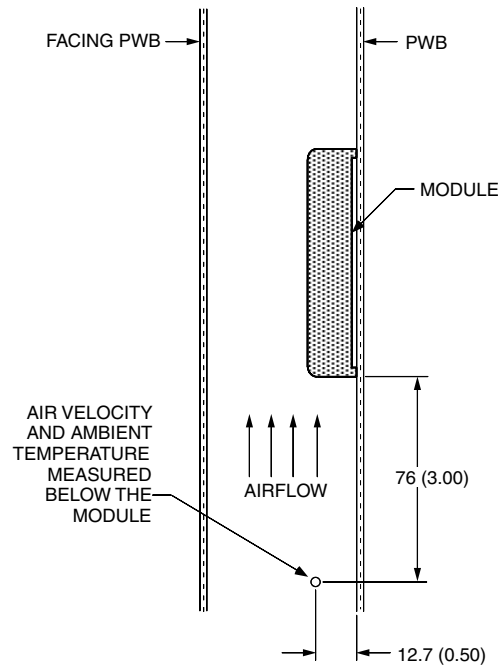

8-1126

Note: Dimensions are in millimeters and (inches).

Figure 26. Experimental Test Setup

Layout Considerations

Copper paths must not be routed beneath the power module standoffs.

Outline Diagram

Dimensions are in millimeters and (inches).

Tolerances: $x.x \pm 0.5$ mm (0.02 in.), $x.xx \pm 0.25$ mm (0.010 in.). Pin-to-pin tolerances are not cumulative.

Note: For standard modules, $V_I(-)$ is internally connected to the case.

Top View

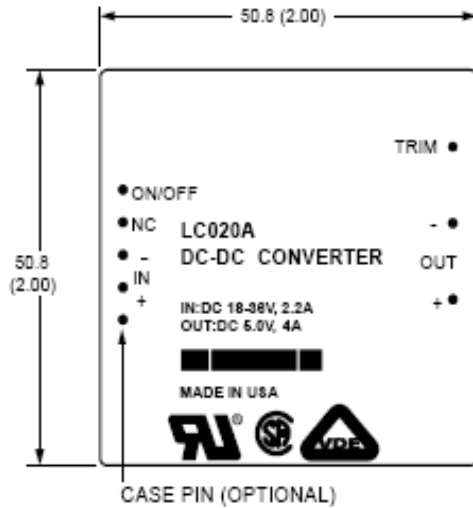

Pin	Function
1	Remote On/Off
2	No Connection (optional-sync feature)
3	$V_I(-)/CASE^-$
4	$V_I(+)$
5	Case Pin (pin optional) [†]
6	TRIM
7	$V_O(-)$
8	$V_O(+)$

[†] Case is not connected to pin 3 if optional case pin 5 is specified.

Side View

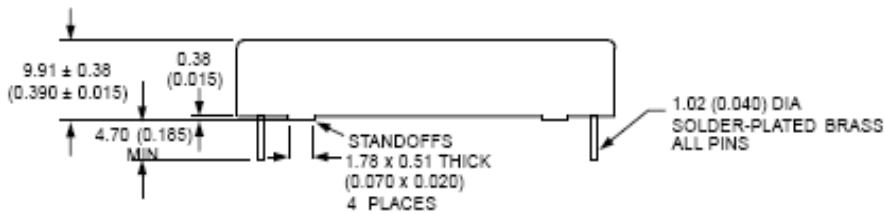

Bottom View

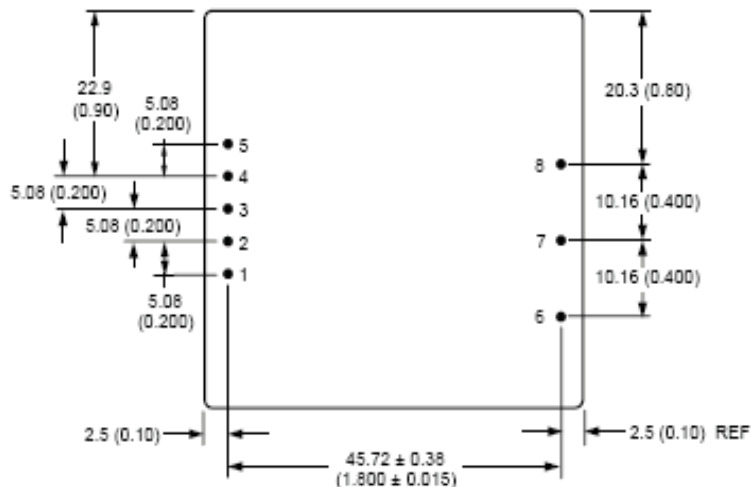

Recommended Hole Pattern

Component-side footprint.

Dimensions are in millimeters and (inches).

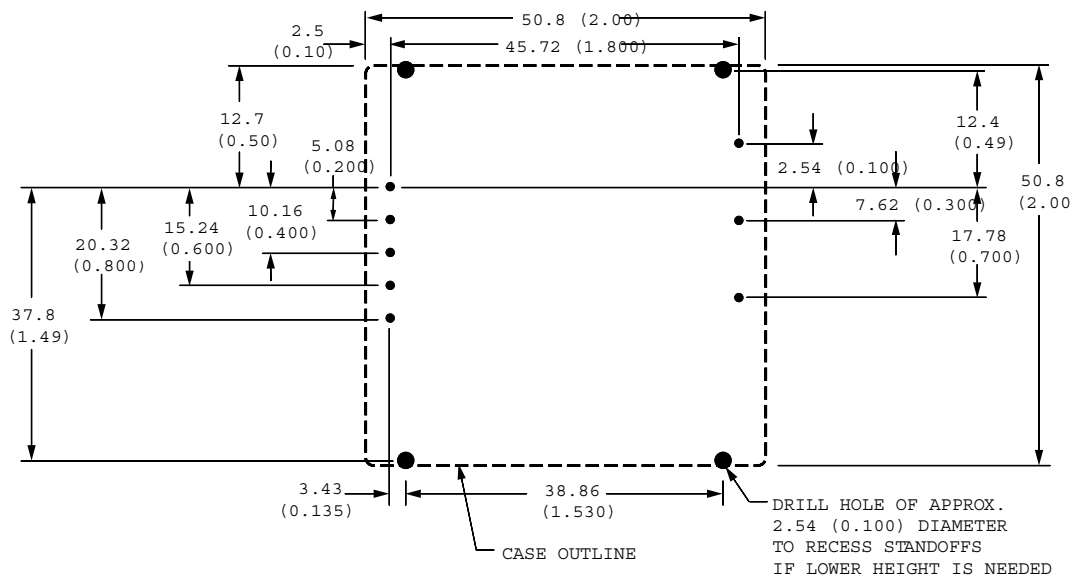

8-1198

Ordering Information

Input Voltage	Output Voltage	Output Power	Device Code	Comcode
28 V	3.3 V	13.2 W	LC020F	107681025
28 V	5 V	20 W	LC020A	107640815
28 V	12 V	20 W	LC020B	107681009
28 V	15 V	20 W	LC020C	107681017

Optional features may be ordered using the device code suffixes shown. To order more than one option, list suffixes in numerically descending order.

Please contact your Lineage Power Account Manager or Field Application Engineer for pricing and availability.

Option	Device Code Suffix
Short pin: 2.79 mm ± 0.25 mm (0.110 in. ± 0.010 in.)	8
Case ground pin	7
Synchronization	3
Negative logic on/off	1



LINEAGE POWER

World Wide Headquarters

Lineage Power Corporation

30 00 Skyline Drive, Mesquite, TX 75149, USA

+1-800-526-7819

(Outside U.S.A.: **+1-97 2-2 84-2626**)

www.lineagepower.com

e-mail: techsupport1@lineagepower.com

Asia-Pacific Headquarters

Tel: +65 6 41 6 4283

Europe, Middle-East and Africa Headquarters

Tel: +49 89 6089 286

India Headquarters

Tel: +91 80 28411633

Lineage Power reserves the right to make changes to the product(s) or information contained herein without notice. No liability is assumed as a result of their use or application. No rights under any patent accompany the sale of any such product(s) or information.

© 2008 Lineage Power Corporation, (Mesquite, Texas) All International Rights Reserved.