



# TAOGLAS®

# Datasheet

## 4G LTE Roadmarker

**Part No:**  
RG.02.02.3000W

**Description:**

Roadmarker Low Profile 4G LTE Cellular Antenna with CAB.820 cable assembly

**Features:**

Low Profile  
4G LTE Cellular Antenna  
UV and Vandal Resistant PP Enclosure  
IP67 Rated Enclosure  
Diameter: 101.4mm  
Height: 17.6mm  
RoHS & Reach Compliant

|  |    |
|--|----|
| 1. Introduction                        | 3  |
| 2. Specifications                      | 4  |
| 3. Antenna Characteristics             | 7  |
| 4. Radiation Patterns                  | 10 |
| 5. Mechanical Drawing – Roadmarker     | 29 |
| 6. Mechanical Drawing – Cable Assembly | 30 |
| 7. Packaging                           | 31 |
| <hr/>                                  |    |
| Changelog                              | 32 |

Taoglas makes no warranties based on the accuracy or completeness of the contents of this document and reserves the right to make changes to specifications and product descriptions at any time without notice. Taoglas reserves all rights to this document and the information contained herein. Reproduction, use or disclosure to third parties without express permission is strictly prohibited.



# 1. Introduction



The Roadmarker RG.02 has been designed to be used inside standard raised non-reflective roadmarkers. These are designed for, and installed inside, the low profile “Bott’s dots” that can to be mounted directly on the pavement and therefore the roads.

The Roadmarker uses a high efficiency 4G LTE antenna that can also operate at 3G/2G and NB-IoT/Cat-M bands, if fallback is required.

These antennas exhibit relatively high efficiencies in such small packages and reside in a very low-profile enclosure. They are designed to be mounted directly on the road and pavement just like a standard roadmarker.

Typical Applications Include:

- Smart Metering
- Remote Monitoring
- Security

These antennas have been potted with the epoxy that is traditionally used to secure the roadmarker itself to the ground. There are no air gaps whatsoever inside the new type approved roadmarker with antenna, in order to maintain the mechanical integrity. It is presumed that the standard black epoxy will also be used to install the roadmarker in its final resting place on the ground.

The cable and connector are fully customizable, for further information please contact your regional Taoglas customer support team.

## 2. Specifications

| Electrical                                    |  |                        |               |                  |                 |           |                 |                   |
|---|--|------------------------|---------------|------------------|-----------------|-----------|-----------------|-------------------|
| Band  | Frequency (MHz)                          |                        | Efficiency(%) | Average Gain(dB) | Peak Gain (dBi) | Impedance | Max Input Power | Radiation Pattern |
| 4G/3G<br>Band 12,13,14,17,28,29               | 698~806                                  | With Cable Assembly    | 28            | -5.7             | 2.1             | 50Ω       | 10W             | Omnidirectional   |
|   |  | Without Cable Assembly | 37            | -4.4             | 3.2             |           |                 |                   |
| 4G/3G/NB-IoT/Cat M<br>Band 5,8,18,19,20,26,27 | 824~960                                  | With Cable Assembly    | 33            | -4.8             | 1.2             |           |                 |                   |
|   |  | Without Cable Assembly | 42            | -3.8             | 2.4             |           |                 |                   |
| 4G/3G<br>Band 1,2,3,4,9,23,25,35,39,66        | 1710~2200                                | With Cable Assembly    | 21            | -7.0             | -0.9            |           |                 |                   |
|   |  | Without Cable Assembly | 27            | -5.8             | 0.8             |           |                 |                   |
| 4G/3G<br>Band 7,30,38,40,41                   | 2300~2690                                | With Cable Assembly    | 27            | -5.7             | 0.0             |           |                 |                   |
|   |  | Without Cable Assembly | 39            | -4.1             | 1.7             |           |                 |                   |
| Mechanical                                    |  |                        |               |                  |                 |           |                 |                   |
| Dimensions (mm)                               | Height = 17.6 mm and Diameter = 101.4 mm |                        |               |                  |                 |           |                 |                   |
| Cable   | WY-100 Coaxial Cable                     |                        |               |                  |                 |           |                 |                   |
| Connector                                     | SMA(M)ST                                 |                        |               |                  |                 |           |                 |                   |
| Casing  | UV Resistant PP                          |                        |               |                  |                 |           |                 |                   |
| Sealant                                       | Potting                                  |                        |               |                  |                 |           |                 |                   |

| Environmental     |                            |
|-------------------|----------------------------|
| Protection        | IP67                       |
| Corrosion         | 5% NaCl for 96hrs          |
| Temperature Range | -40°C to +85°C             |
| Thermal Shock     | 100 cycles -40°C to +85°C  |
| Humidity          | Non-condensing 65°C 95% RH |
| Shock (Drop Test) | 1m drop on concrete 6 axes |
| Cable Pull        | 8 Kgf                      |

*Tested with 1.5m of cable and with the additional 1.5m cable assembly.*

| 5G/4G Bands |   |                      |         |
|-------------|---|----------------------|---------|
| Band Number | 5GNR / FR1 / LTE / LTE-Advanced / WCDMA / HSPA / HSPA+ / TD-SCDMA |                      |         |
|             | Uplink  | Downlink             | Covered |
| 1           | UL: 1920 to 1980  | DL: 2110 to 2170     | ✓       |
| 2           | UL: 1850 to 1910  | DL: 1930 to 1990     | ✓       |
| 3           | UL: 1710 to 1785  | DL: 1805 to 1880     | ✓       |
| 4           | UL: 1710 to 1755  | DL: 2110 to 2155     | ✓       |
| 5           | UL: 824 to 849  | DL: 869 to 894       | ✓       |
| 7           | UL: 2500 to 2570  | DL: 2620 to 2690     | ✓       |
| 8           | UL: 880 to 915  | DL: 925 to 960       | ✓       |
| 9           | UL: 1749.9 to 1784.9  | DL: 1844.9 to 1879.9 | ✓       |
| 11          | UL: 1427.9 to 1447.9  | DL: 1475.9 to 1495.9 | ✓       |
| 12          | UL: 699 to 716  | DL: 729 to 746       | ✓       |
| 13          | UL: 777 to 787  | DL: 746 to 756       | ✓       |
| 14          | UL: 788 to 798  | DL: 758 to 768       | ✓       |
| 17          | UL: 704 to 716  | DL: 734 to 746       | ✓       |
| 18          | UL: 815 to 830  | DL: 860 to 875       | ✓       |
| 19          | UL: 830 to 845  | DL: 875 to 890       | ✓       |
| 20          | UL: 832 to 862  | DL: 791 to 821       | ✓       |
| 21          | UL: 1447.9 to 1462.9  | DL: 1495.9 to 1510.9 | ✓       |
| 22          | UL: 3410 to 3490  | DL: 3510 to 3590     | ✓       |
| 23          | UL: 2000 to 2020  | DL: 2180 to 2200     | ✓       |
| 24          | UL: 1625.5 to 1660.5  | DL: 1525 to 1559     | ✓       |
| 25          | UL: 1850 to 1915  | DL: 1930 to 1995     | ✓       |
| 26          | UL: 814 to 849  | DL: 859 to 894       | ✓       |
| 27          | UL: 807 to 824  | DL: 852 to 869       | ✓       |
| 28          | UL: 703 to 748  | DL: 758 to 803       | ✓       |
| 29          | UL: -   | DL: 717 to 728       | ✓       |
| 30          | UL: 2305 to 2315  | DL: 2350 to 2360     | ✓       |
| 31          | UL: 452.5 to 457.5  | DL: 462.5 to 467.5   | ✗       |
| 32          | UL: -   | DL: 1452 – 1496      | ✓       |
| 35          |   | 1850 to 1910         | ✓       |
| 38          |   | 2570 to 2620         | ✓       |
| 39          |   | 1880 to 1920         | ✓       |
| 40          |   | 2300 to 2400         | ✓       |
| 41          |   | 2496 to 2690         | ✓       |
| 42          |   | 3400 to 3600         | ✗       |
| 43          |   | 3600 to 3800         | ✗       |
| 48          |   | 3550 to 3700         | ✗       |
| 66          | UL: 1710-1780   | DL: 2110-2200        | ✗       |
| 71          |   | 617 to 698           | ✗       |
| 74/75/76    |   | 1427 to 1518         | ✓       |
| 77          |   | 3300 to 4200         | ✗       |
| 78          |   | 3300 to 3800         | ✗       |
| 79          |   | 4400 to 5000         | ✗       |

### 3. Antenna Characteristics

#### 3.1 Return Loss

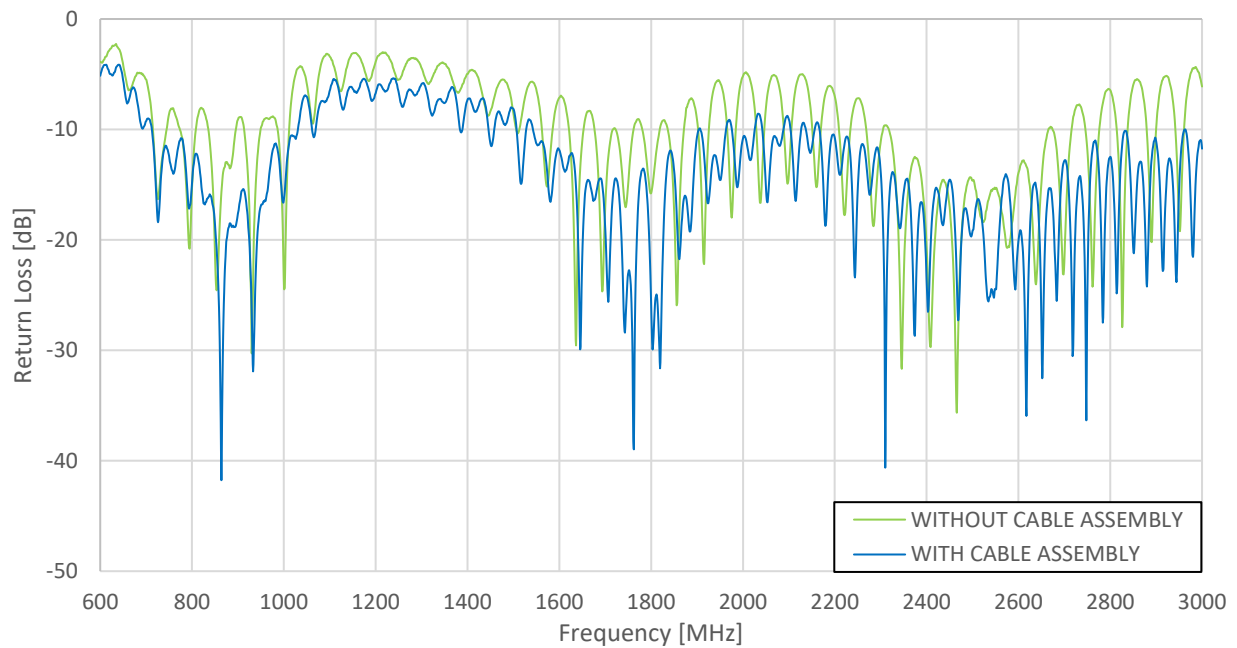

#### 3.2 VSWR

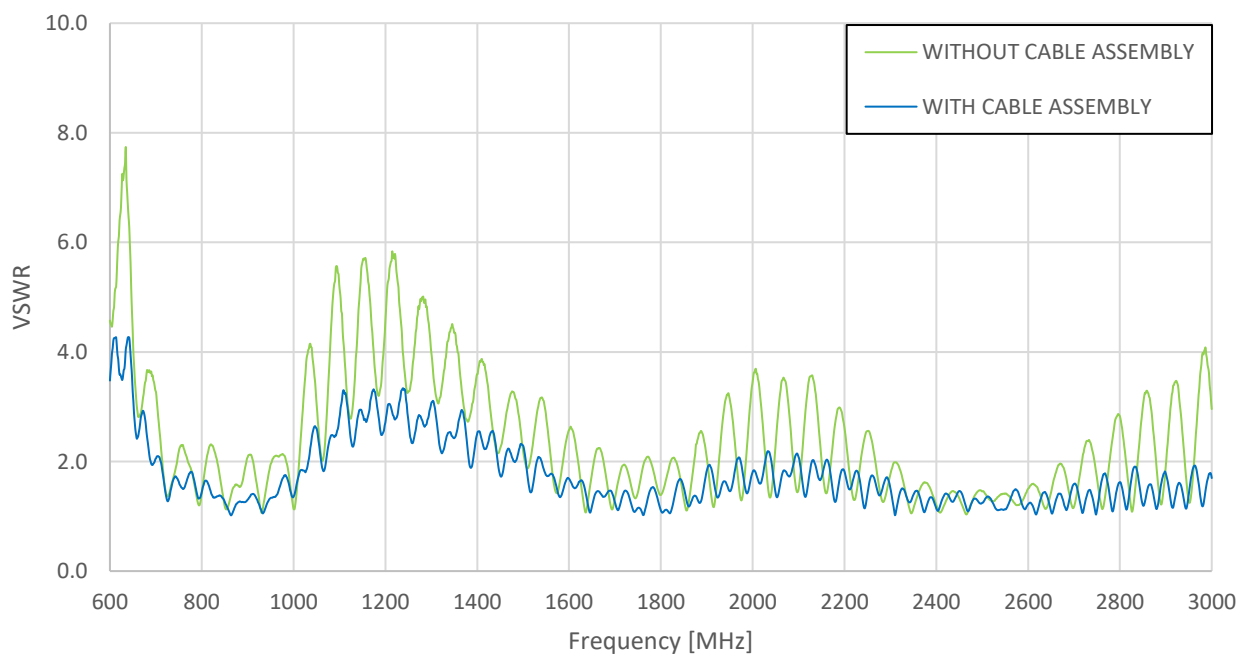

### 3.3 Efficiency

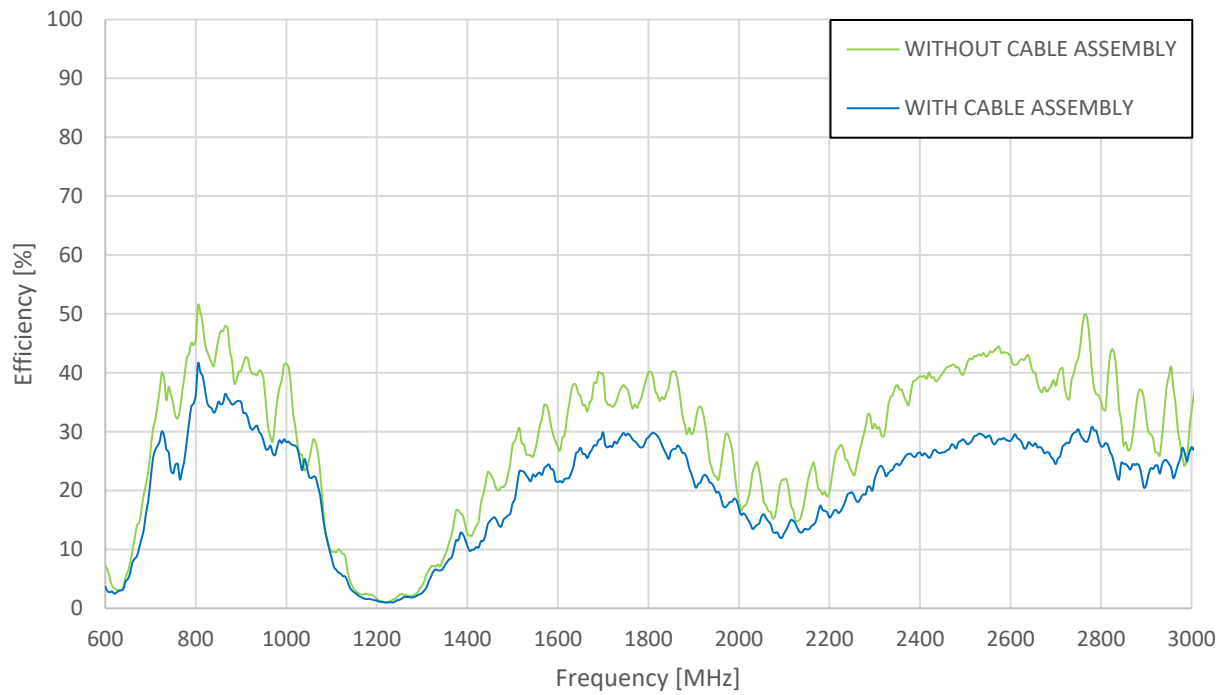

### 3.4 Peak Gain

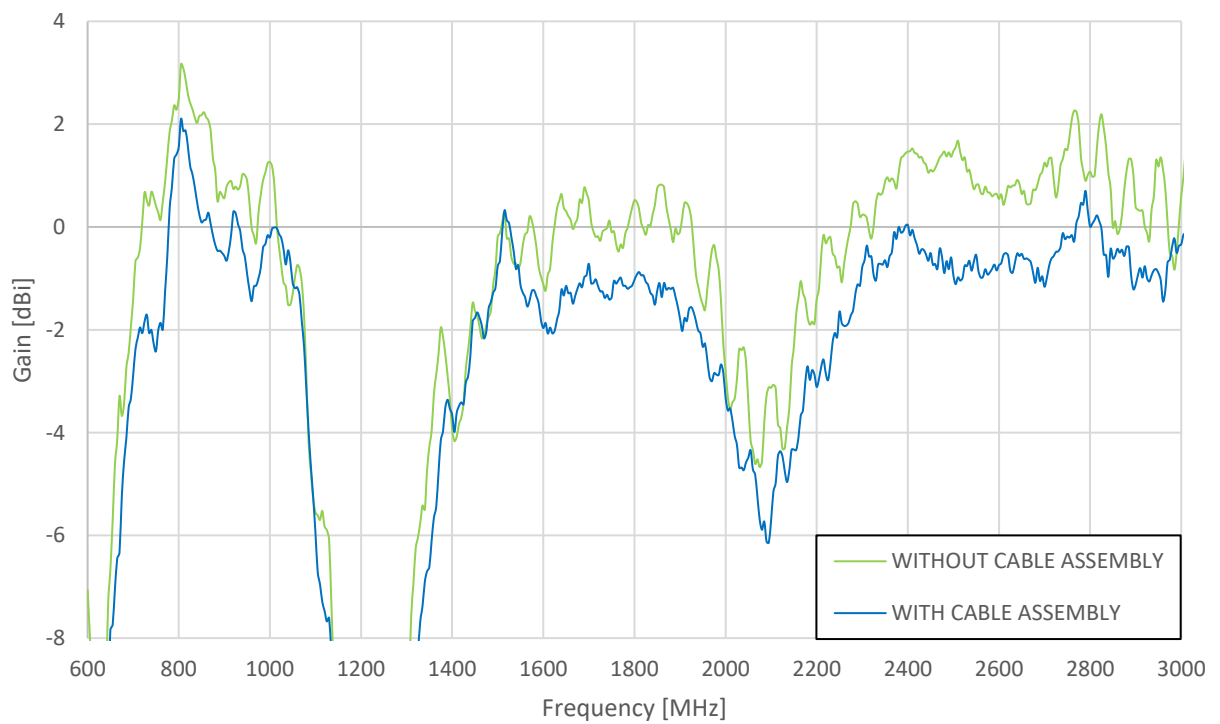



### 3.5 Average Gain

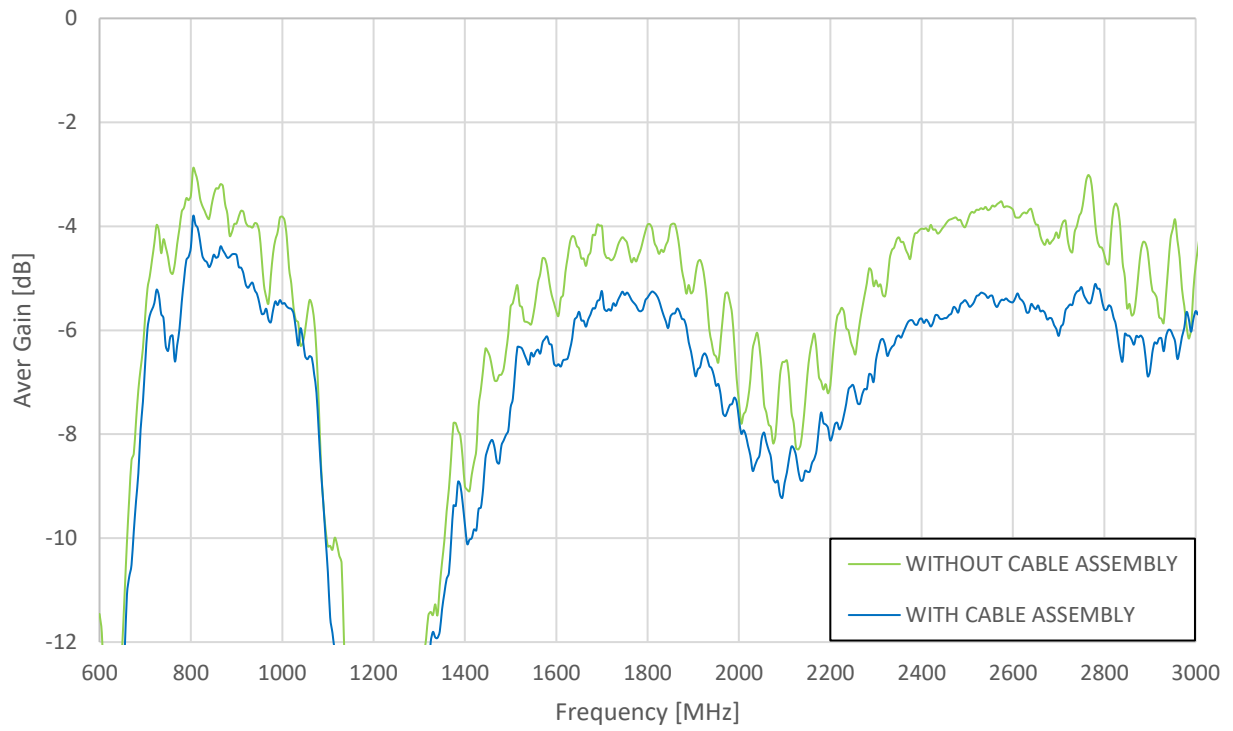

## 4. Radiation Patterns

### 4.1 Test Setup

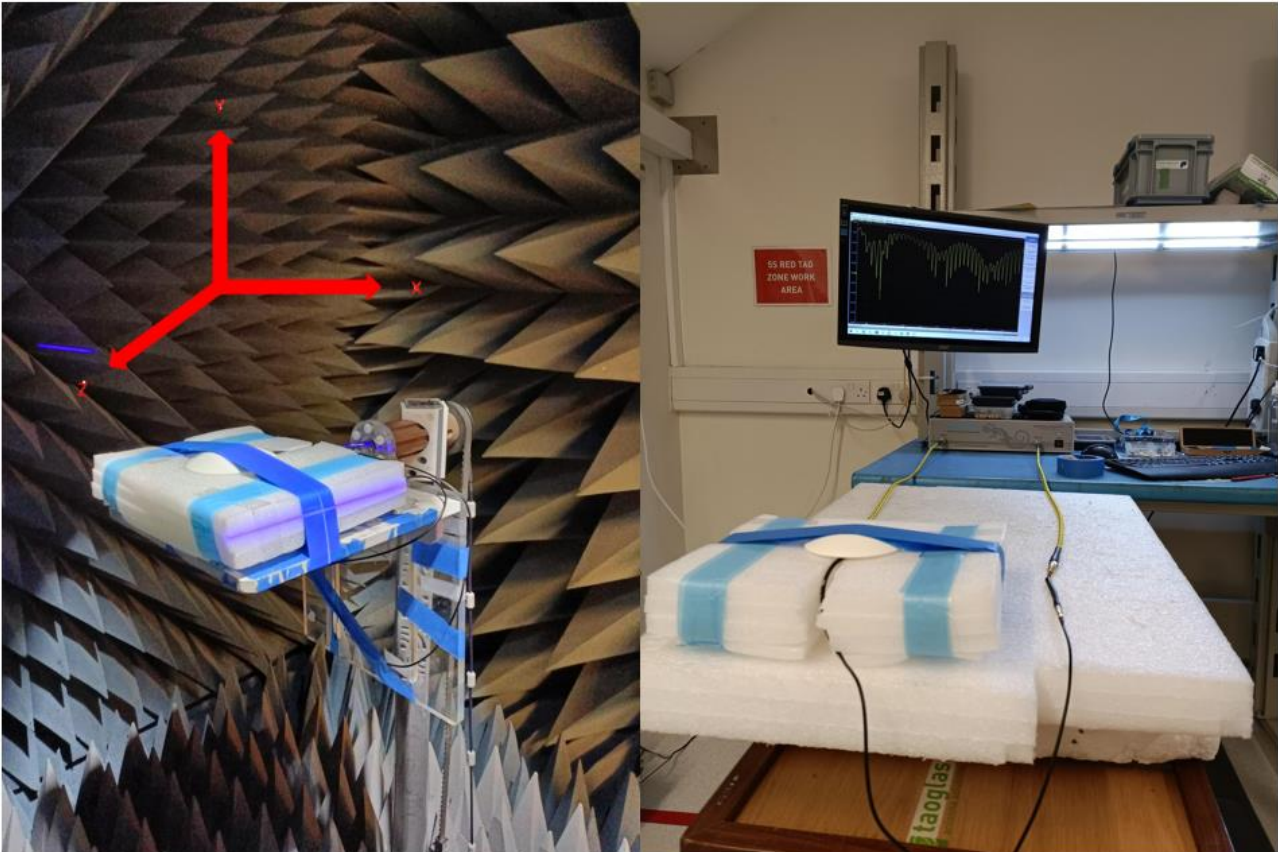

Chamber Set up

VNA Set up

4.2 700MHz 3D and 2D Radiation Patterns (Without Cable Assembly)

Azimuth = 0.0  
Elevation = 0.0  
Roll = -35.0

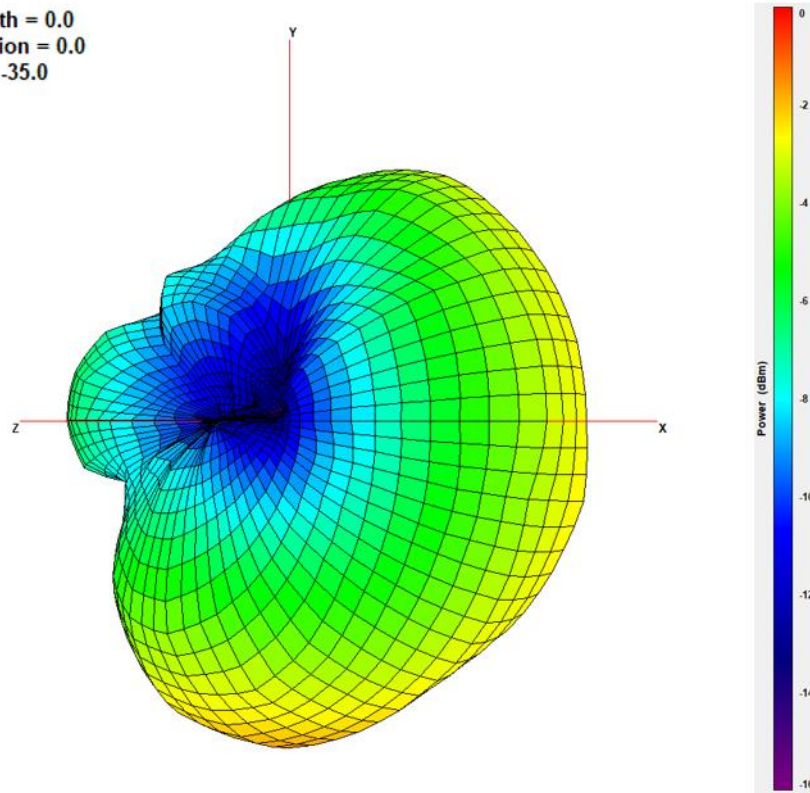

XY Plane      XZ Plane      YZ Plane

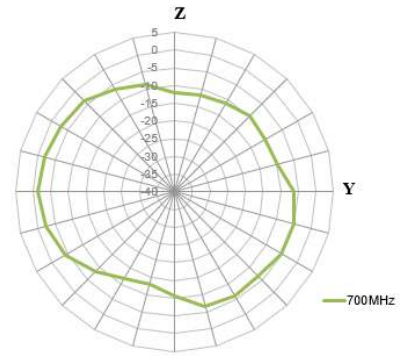
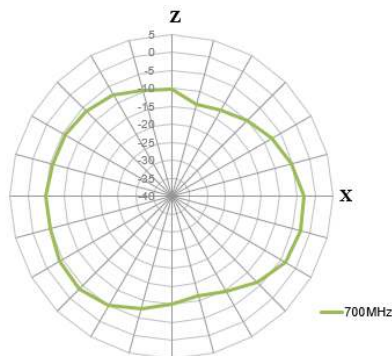
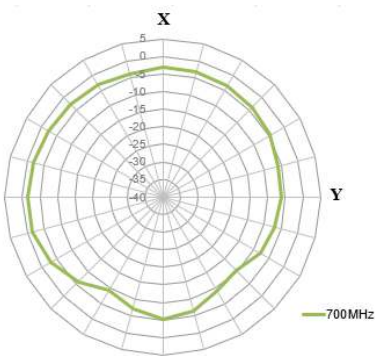

850MHz

Azimuth = 0.0  
 Elevation = 0.0  
 Roll = -35.0

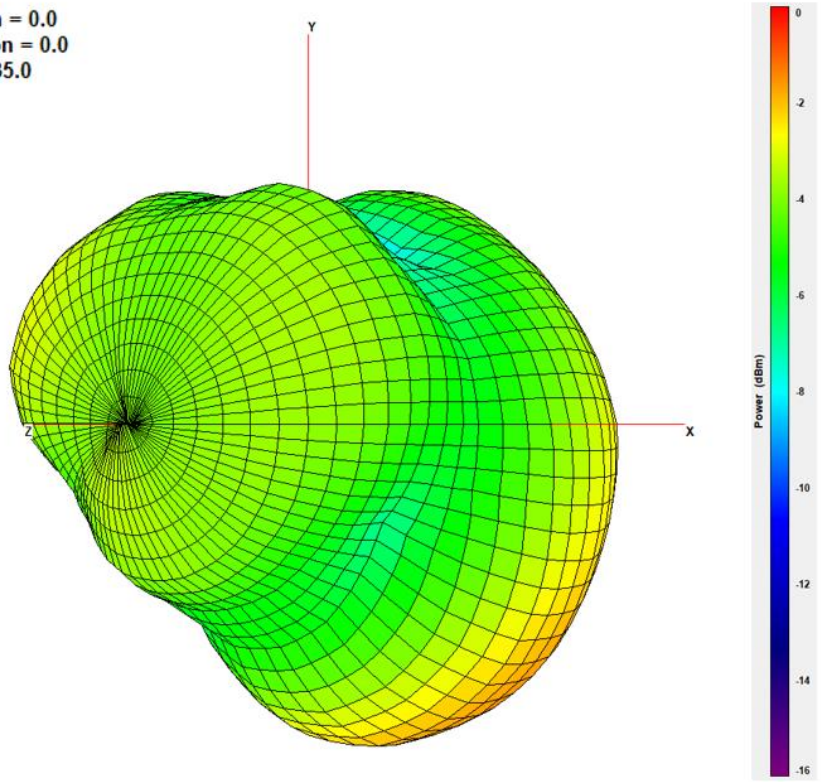

XY Plane

XZ Plane

YZ Plane

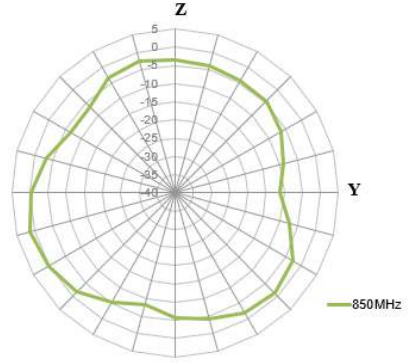
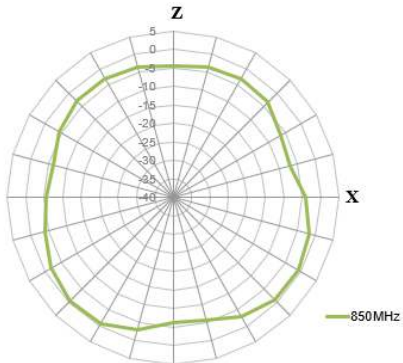
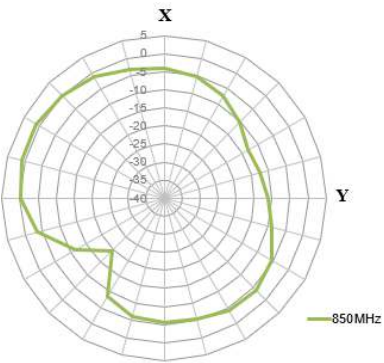



900MHz

Azimuth = 0.0  
Elevation = 0.0  
Roll = -35.0

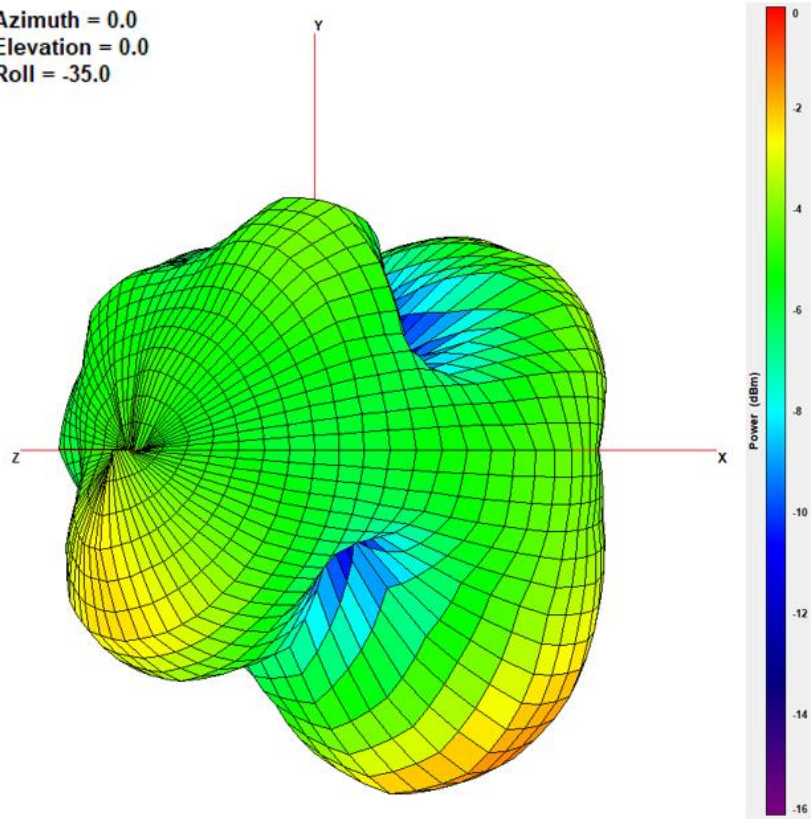

XY Plane

XZ Plane

YZ Plane

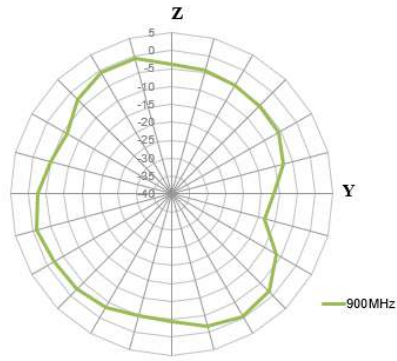
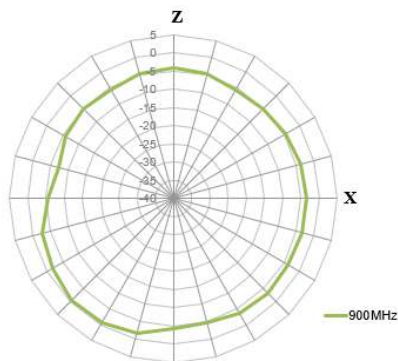
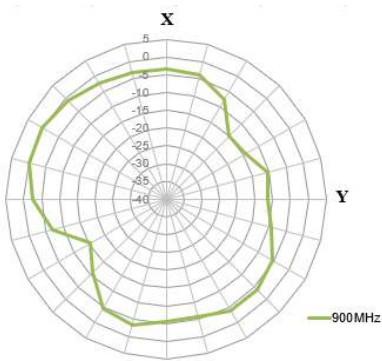

1710MHz

Azimuth = 0.0  
Elevation = 0.0  
Roll = -35.0

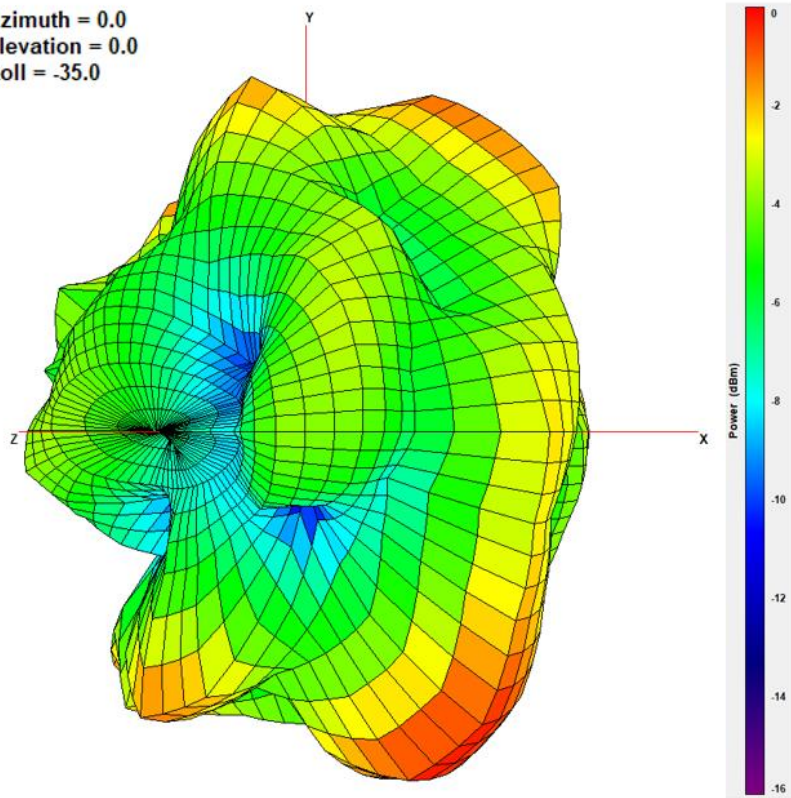

XY Plane

XZ Plane

YZ Plane

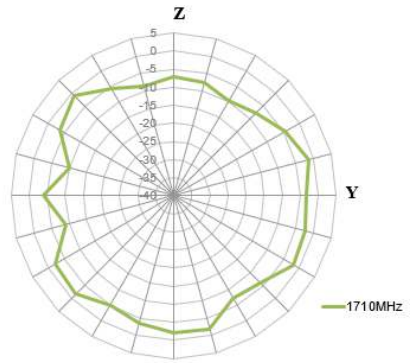
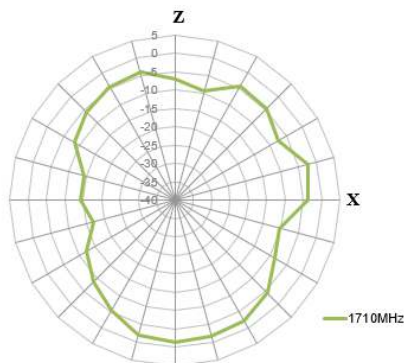
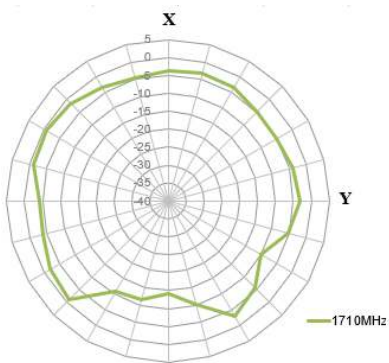

1800MHz

Azimuth = 0.0  
Elevation = 0.0  
Roll = -35.0

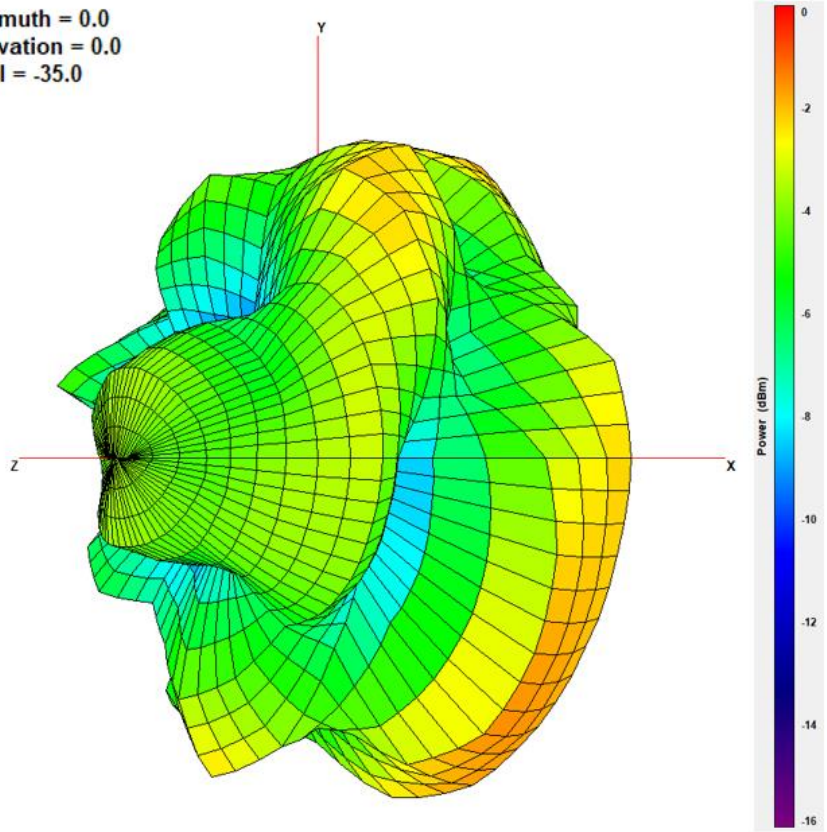

XY Plane

XZ Plane

YZ Plane

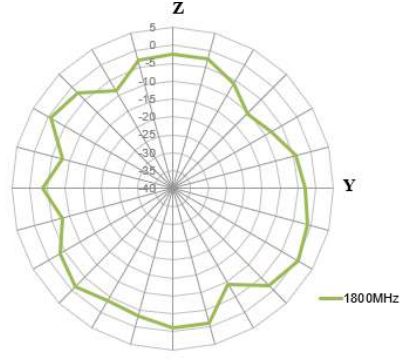
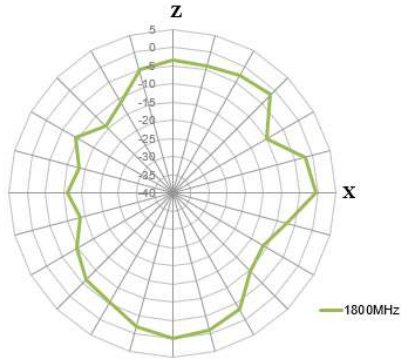
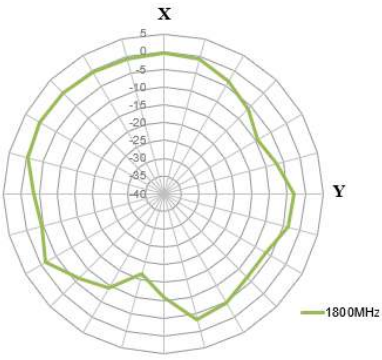



1910MHz

Azimuth = 0.0  
Elevation = 0.0  
Roll = -35.0

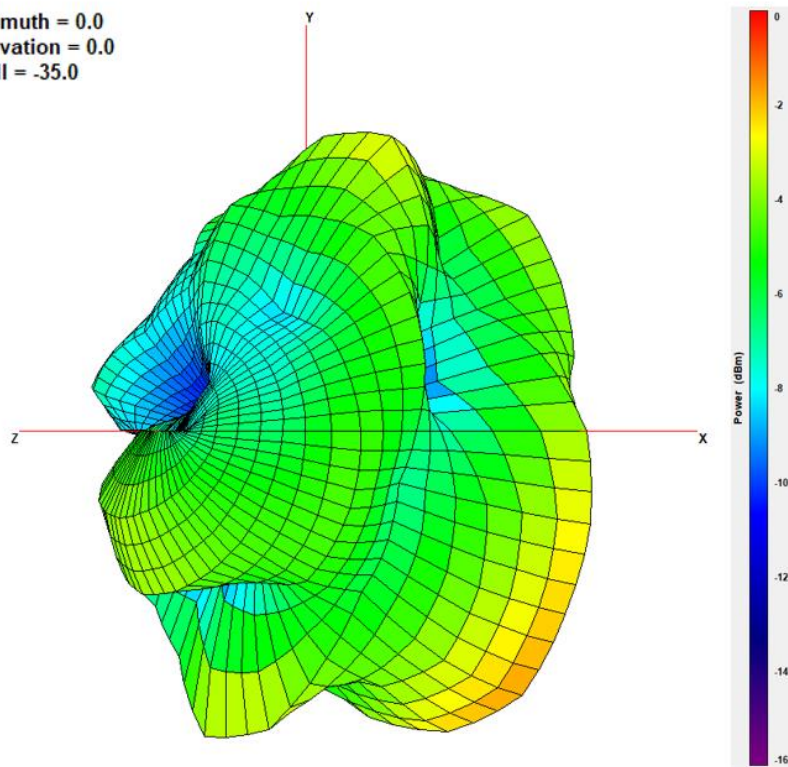

XY Plane

XZ Plane

YZ Plane

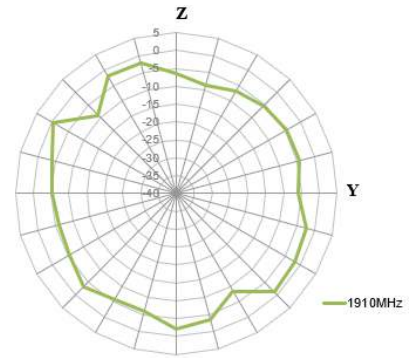
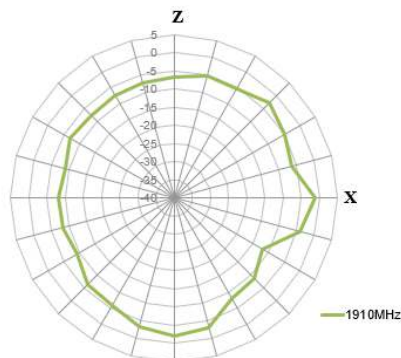
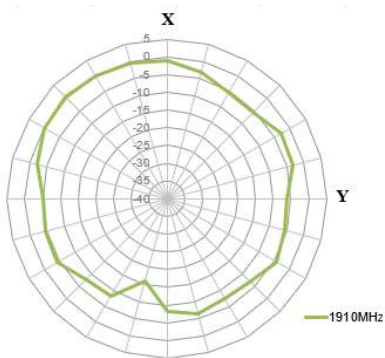



2450MHz

Azimuth = 0.0  
Elevation = 0.0  
Roll = -35.0

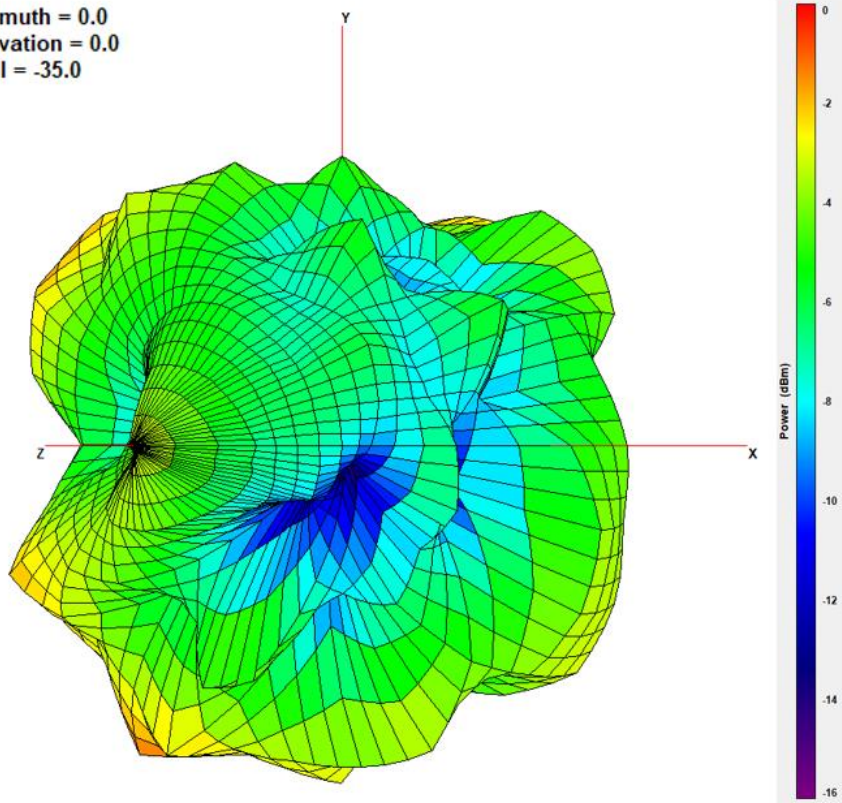

XY Plane

XZ Plane

YZ Plane

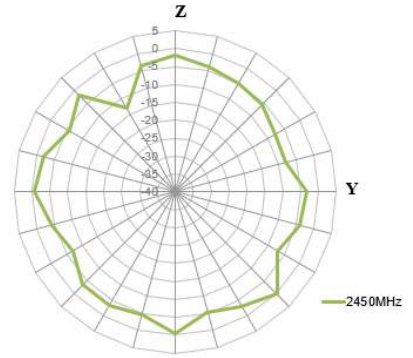
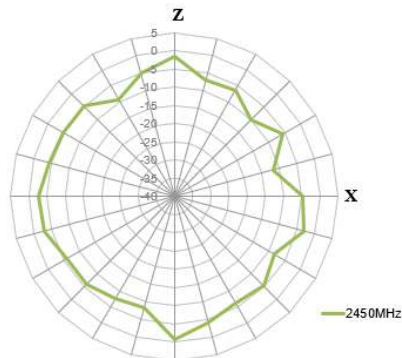
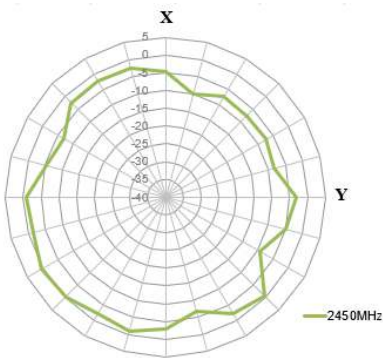

# 2500MHz

Azimuth = 0.0  
 Elevation = 0.0  
 Roll = -35.0

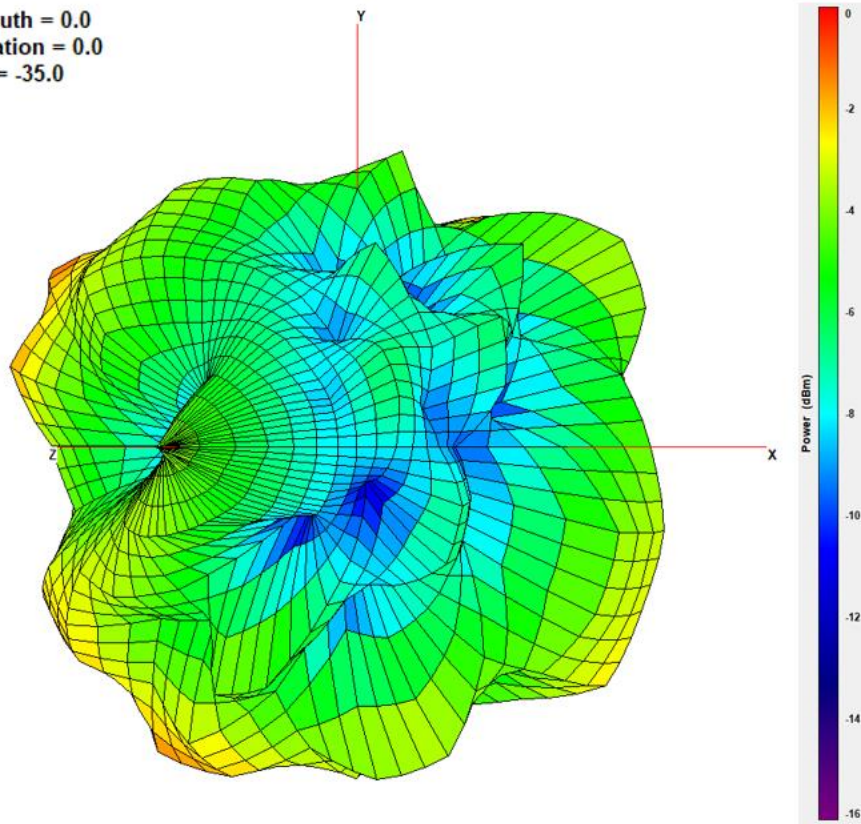

XY Plane

XZ Plane

YZ Plane

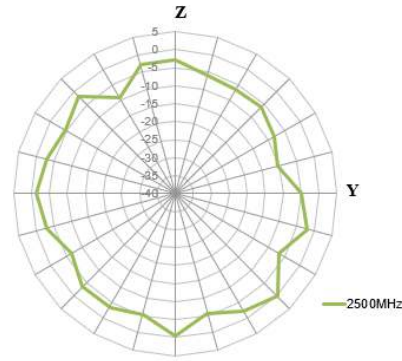
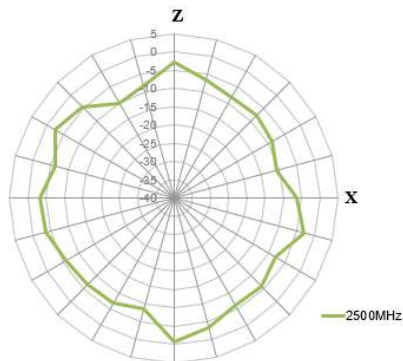
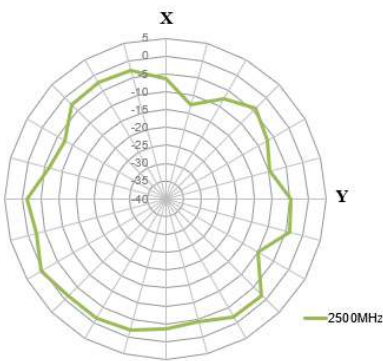

2600MHz

Azimuth = 0.0  
 Elevation = 0.0  
 Roll = -35.0

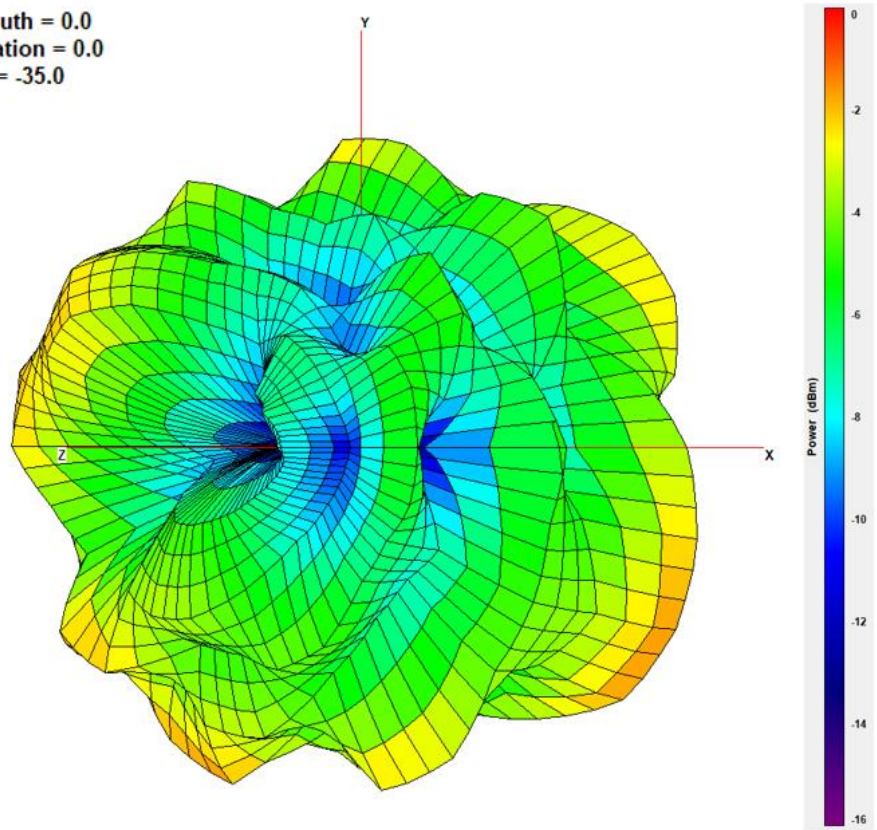

XY Plane

XZ Plane

YZ Plane

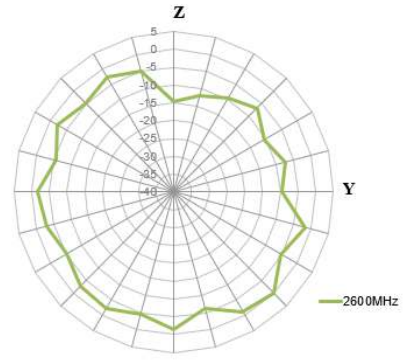
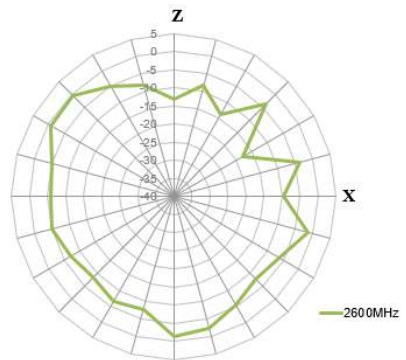
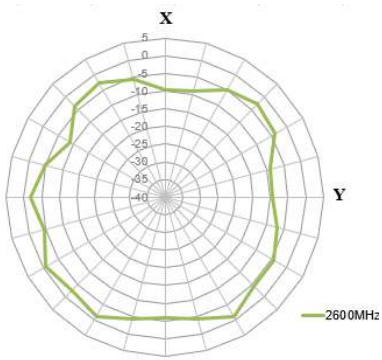



### 4.3 700MHz 3D and 2D Radiation Patterns (With Cable Assembly)

Azimuth = 0.0  
 Elevation = 0.0  
 Roll = -35.0

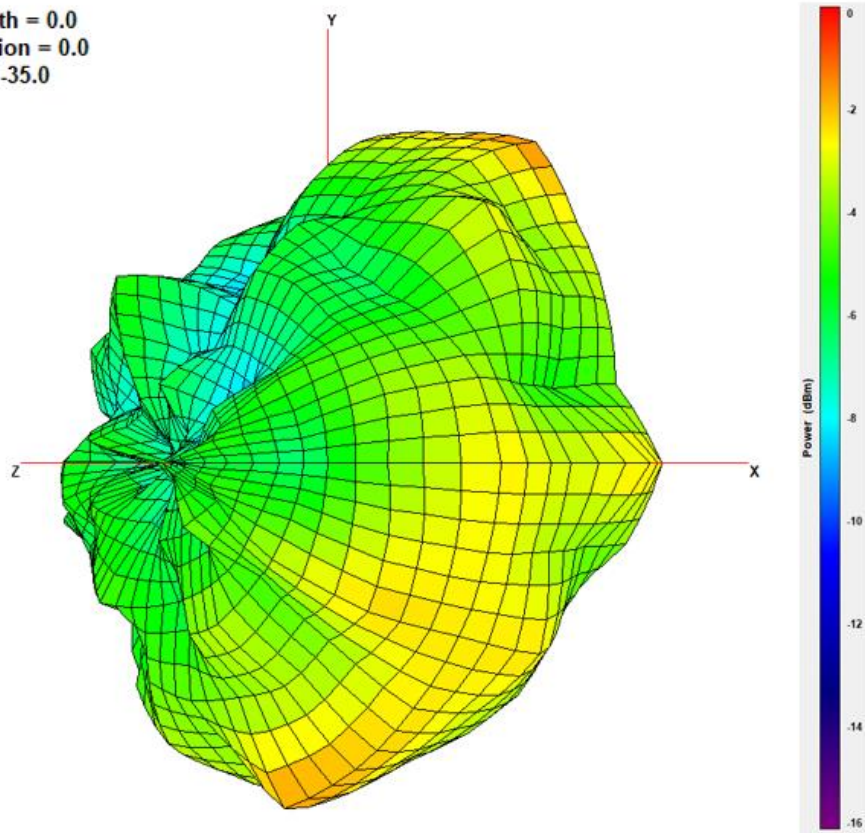

XY Plane

XZ Plane

YZ Plane

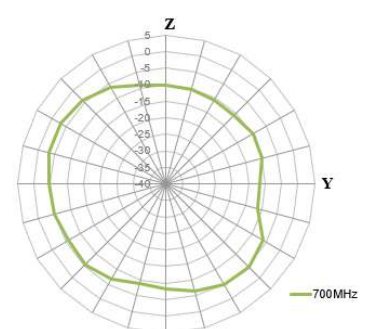
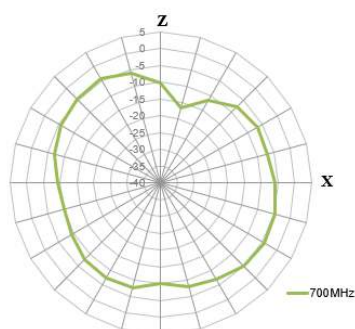
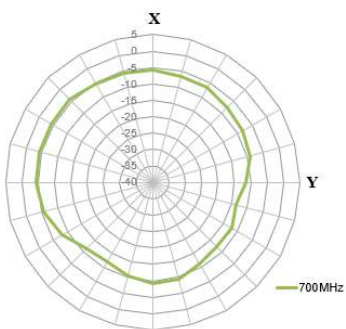

850MHz

Azimuth = 0.0  
Elevation = 0.0  
Roll = -35.0

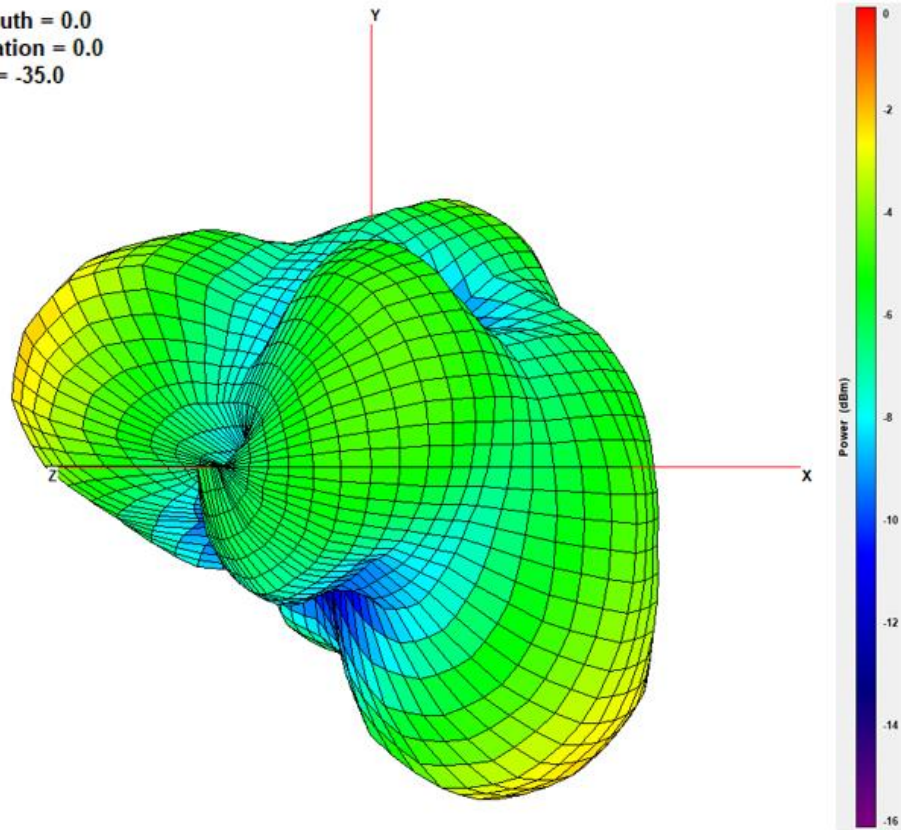

XY Plane

XZ Plane

YZ Plane

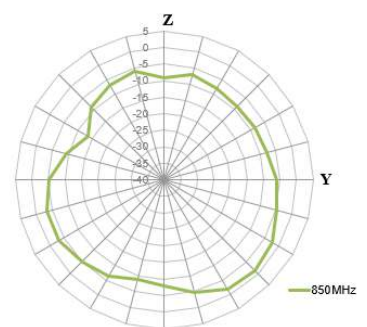
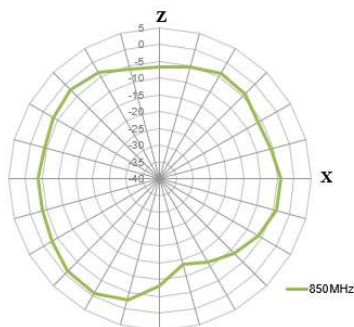
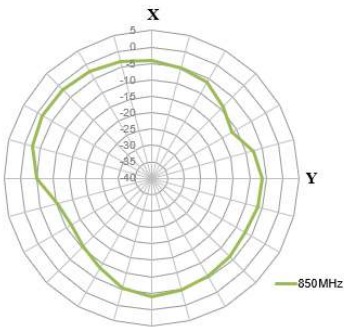

900MHz

Azimuth = 0.0  
 Elevation = 0.0  
 Roll = -35.0

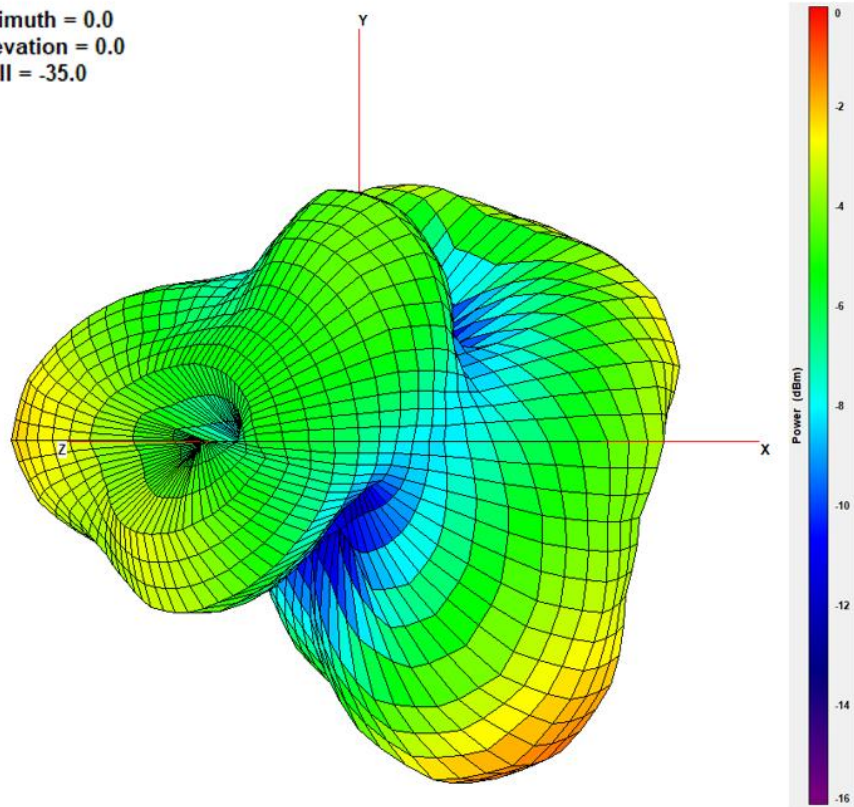

XY Plane

XZ Plane

YZ Plane

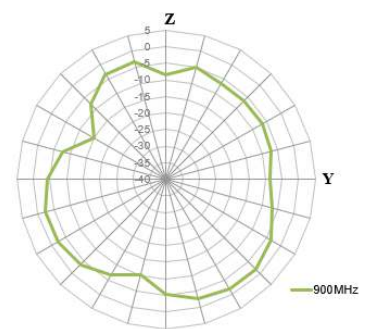
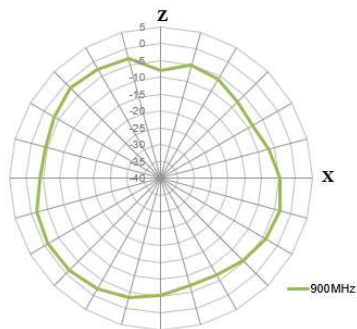
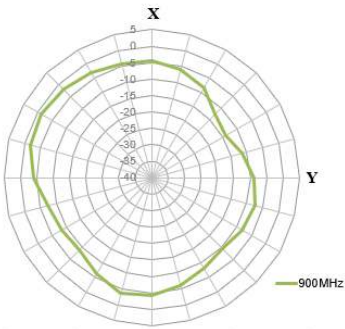

1710MHz

Azimuth = 0.0  
 Elevation = 0.0  
 Roll = -35.0

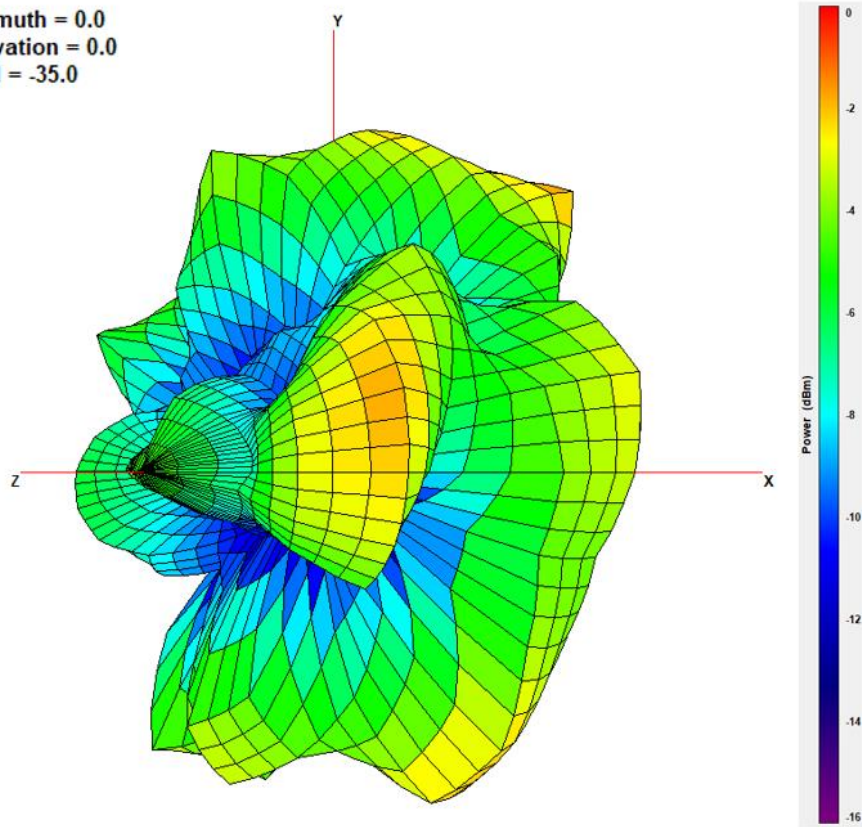

XY Plane

XZ Plane

YZ Plane

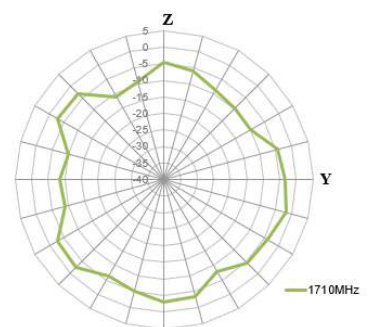
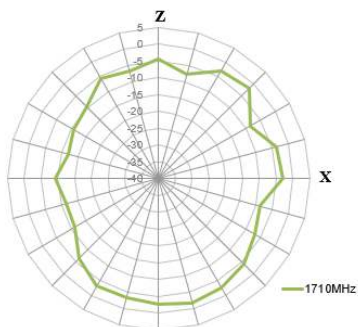
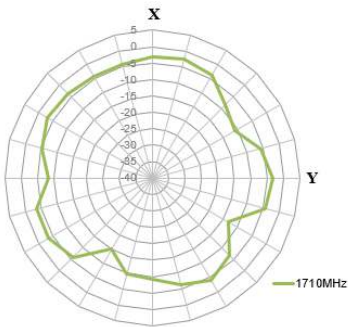



1800MHz

Azimuth = 0.0  
 Elevation = 0.0  
 Roll = -35.0

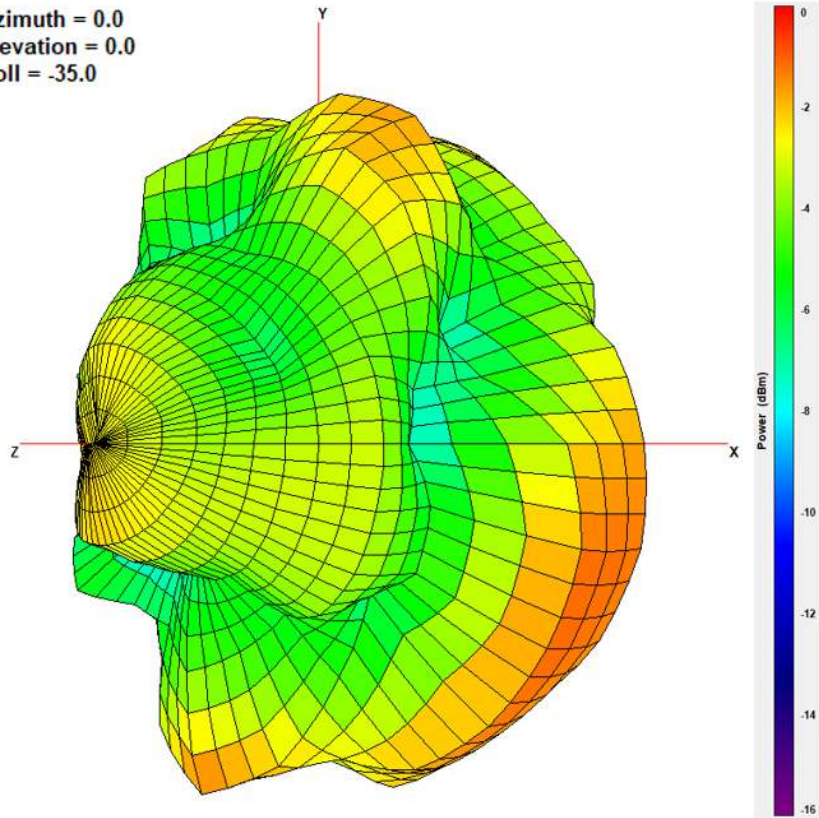

XY Plane

XZ Plane

YZ Plane

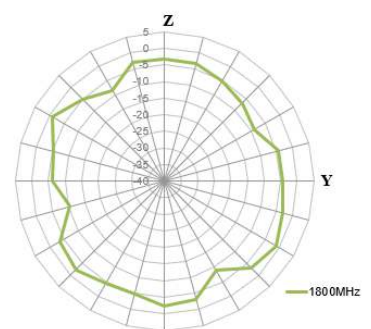
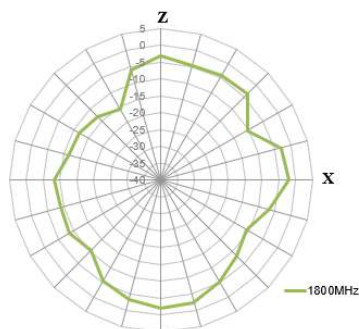
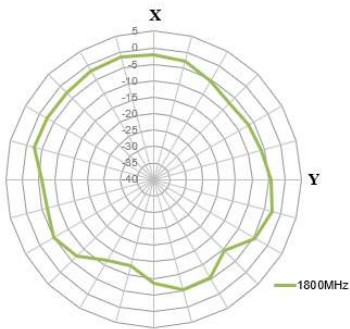



1910MHz

Azimuth = 0.0  
Elevation = 0.0  
Roll = -35.0

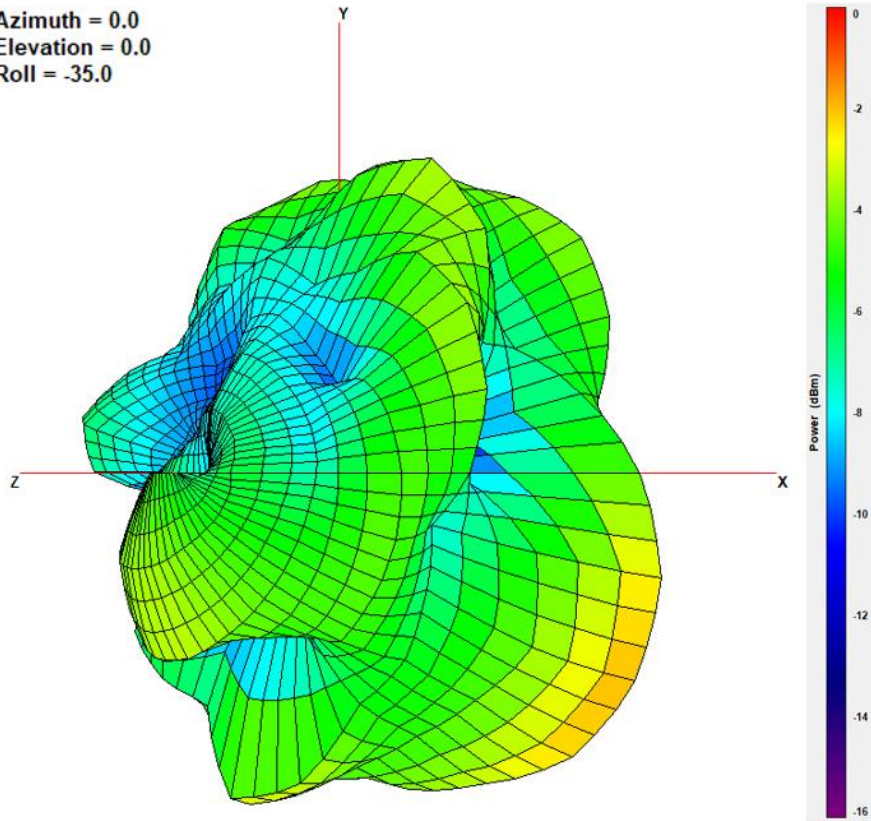

XY Plane

XZ Plane

YZ Plane

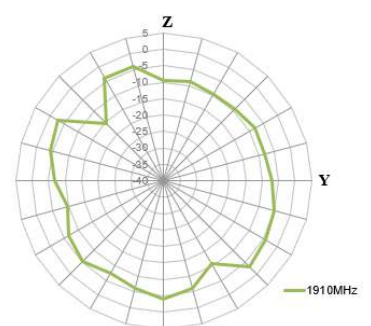
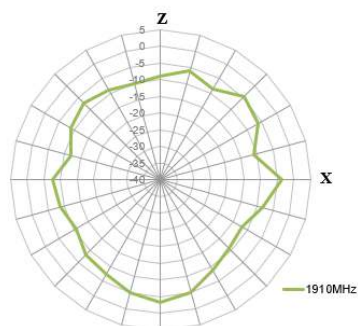
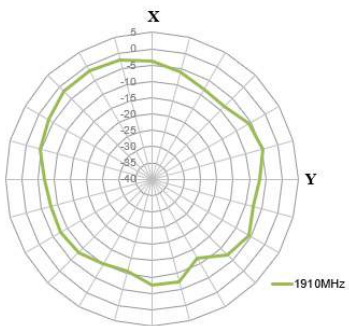

2450MHz

Azimuth = 0.0  
Elevation = 0.0  
Roll = -35.0

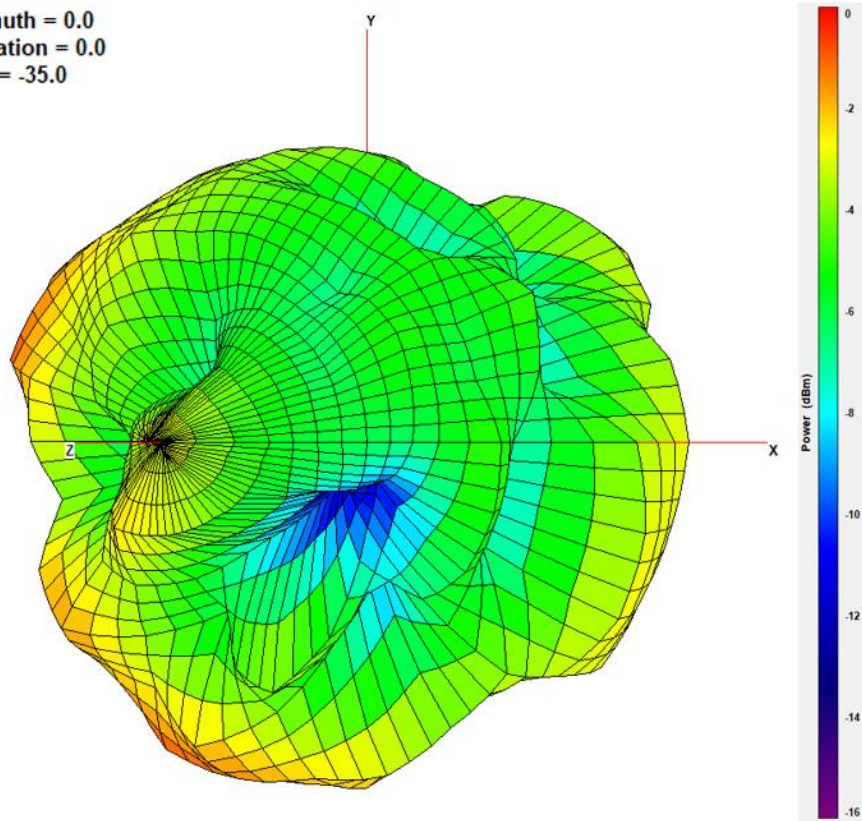

XY Plane

XZ Plane

YZ Plane

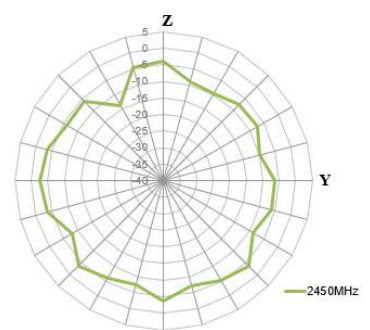
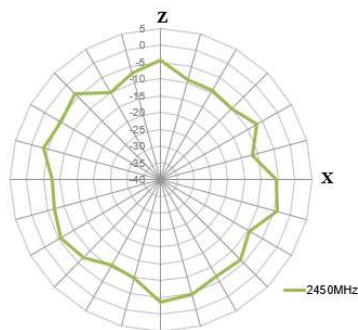
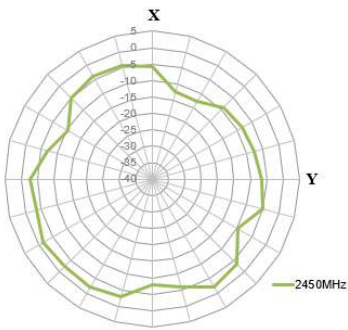

2500MHz

Azimuth = 0.0  
 Elevation = 0.0  
 Roll = -35.0

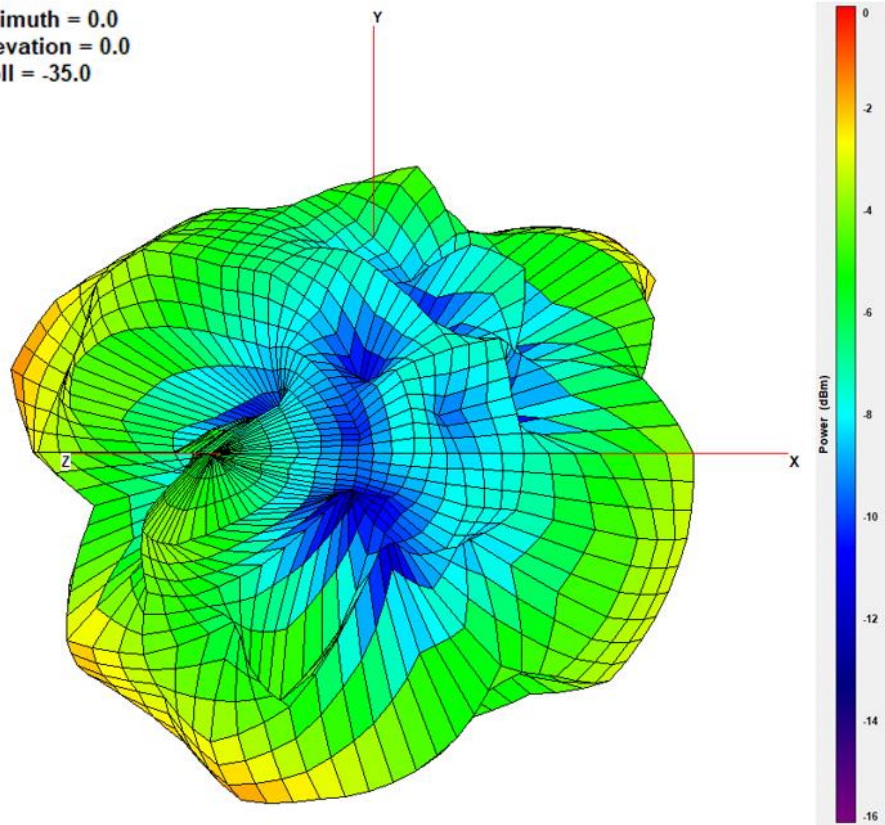

XY Plane

XZ Plane

YZ Plane

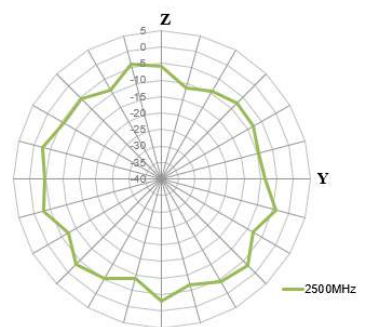
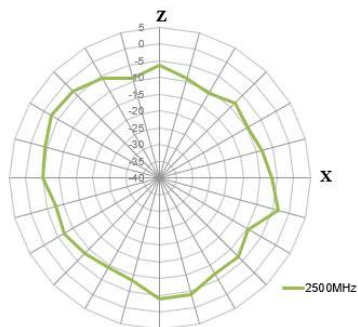
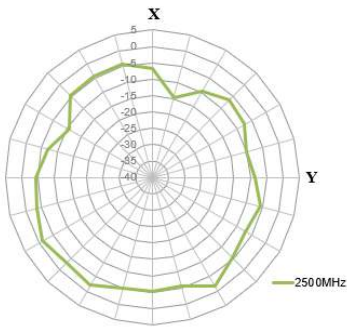



2600MHz

Azimuth = 0.0  
Elevation = 0.0  
Roll = -35.0

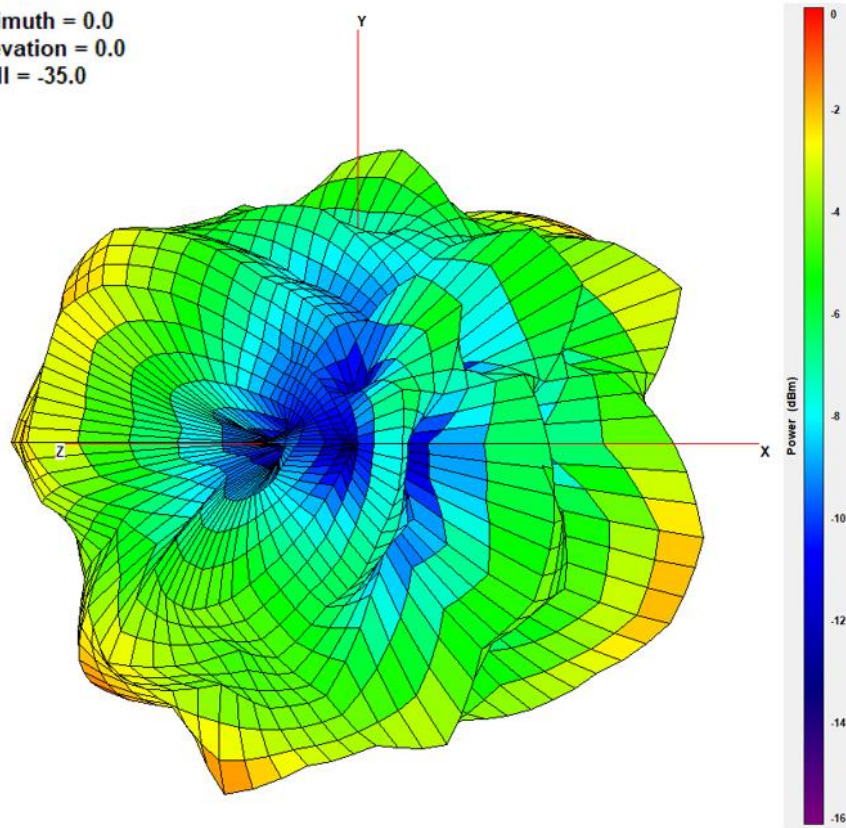

XY Plane

XZ Plane

YZ Plane

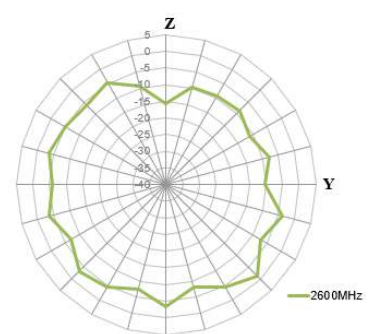
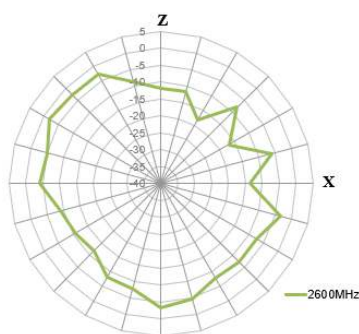
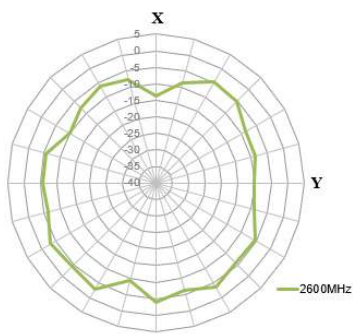

# 5. Mechanical Drawing – Roadmarker

Top View

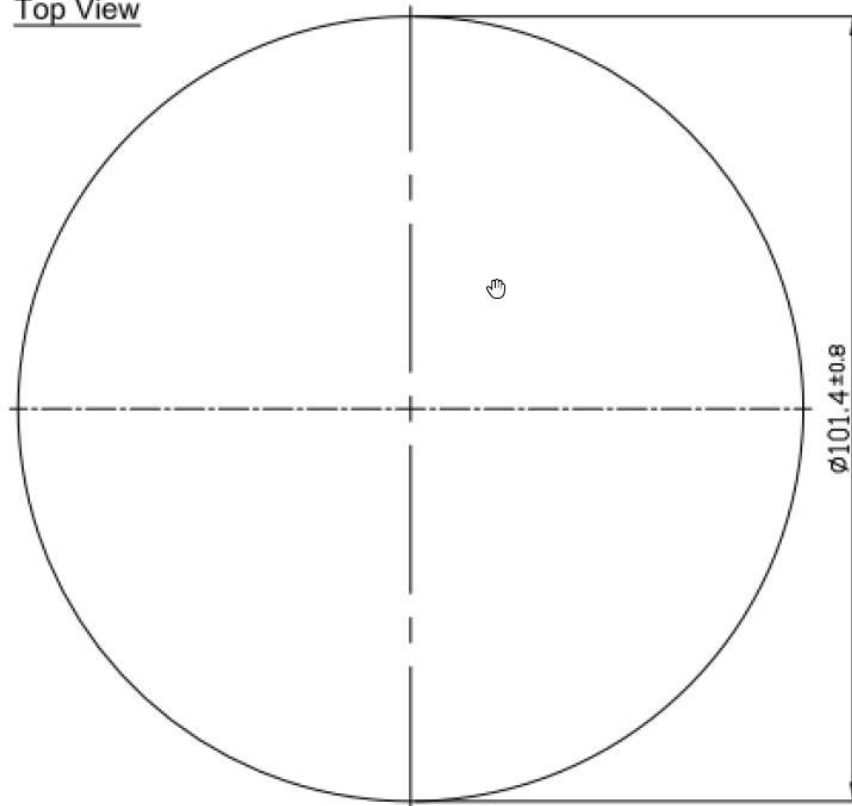

Front View

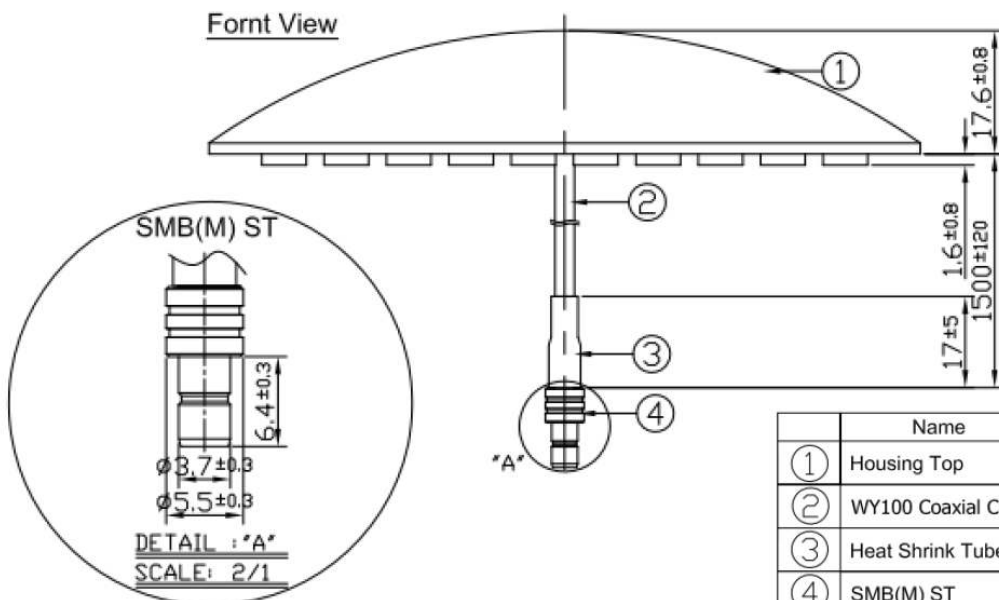

|   | Name                | Material | Finish | QTY |
|---|---------------------|----------|--------|-----|
| ① | Housing Top         | PP       | White  | 1   |
| ② | WY100 Coaxial Cable | PVC      | Black  | 1   |
| ③ | Heat Shrink Tube    | PE       | Black  | 1   |
| ④ | SMB(M) ST           | Brass    | Gold   | 1   |

# 6. Mechanical Drawing – Cable Assembly

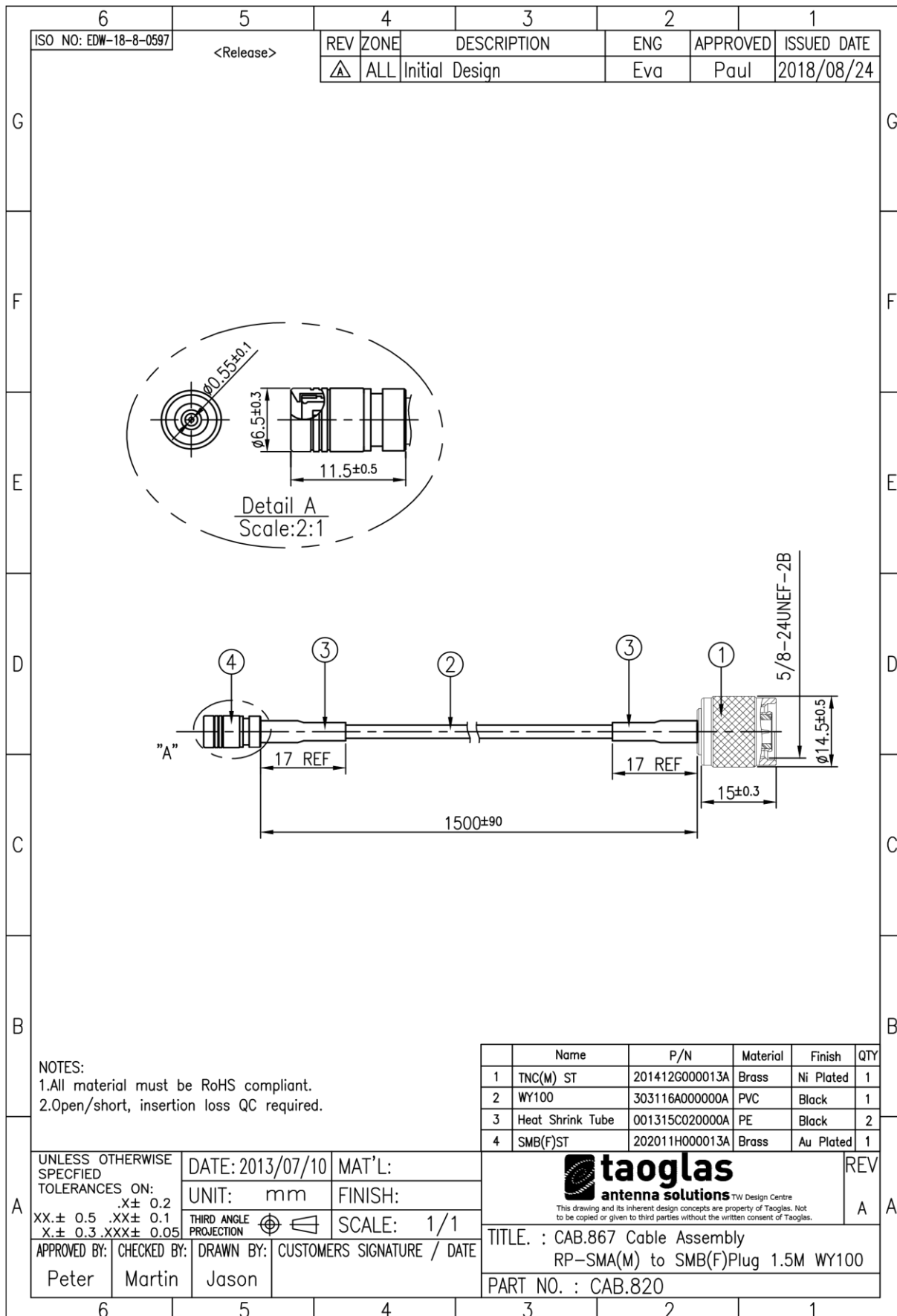

## 7. Packaging

1pcs RG.02.02.3000W per carton  
 Dimensions - 350\*340\*47mm  
 Weight - 92g

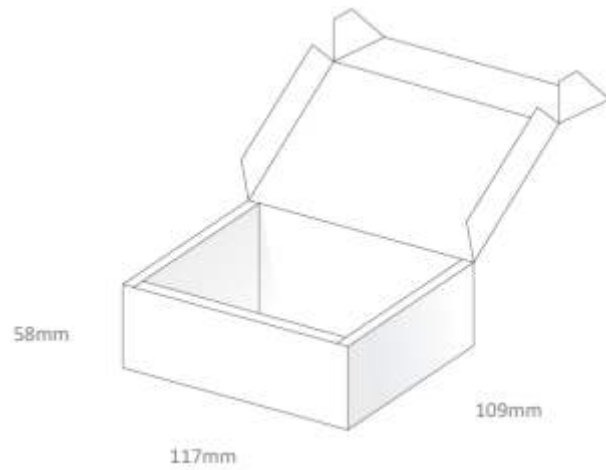

24pcs RG.02.02.3000W per carton  
 Dimensions - 589\*296\*135mm  
 Weight - 2.4Kg

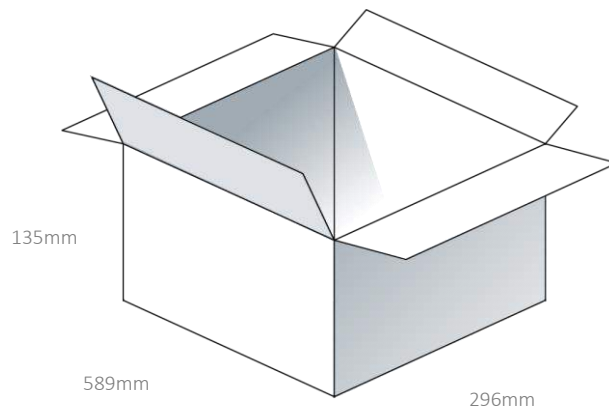

Changelog for the datasheet

**SPE-14-8-038 – RG.02.02.3000W**

**Revision: F (Current Version)**

|                  |               |
|------------------|---------------|
| Date:            | 2022-01-24    |
| Changes:         | Updated data. |
| Changes Made by: | Gary West     |

**Previous Revisions**

**Revision: E**

|                  |                         |
|------------------|-------------------------|
| Date:            | 2020-01-23              |
| Changes:         | Updated data to show 4G |
| Changes Made by: | Jack Conroy             |

**Revision: D**

|                  |   |
|------------------|---|
| Date:            | 2017-01-08  |
| Changes:         | Updated to remove reference to manhole covers as per request by KB. Also added disclaimer |
| Changes Made by: | Andy Mahoney  |

**Revision: C**

|                  |            |
|------------------|------------|
| Date:            | 2014-05-16 |
| Changes:         |            |
| Changes Made by: | Aine Doyle |

**Revision: B**

|                  |            |
|------------------|------------|
| Date:            | 2014-04-23 |
| Changes:         |            |
| Changes Made by: | Aine Doyle |

**Revision: A (Original First Release)**

|         |            |
|---------|------------|
| Date:   | 2014-08-17 |
| Notes:  |            |
| Author: | Aine Doyle |





**TAOGLAS**®

[www.taoglas.com](http://www.taoglas.com)

