

ADA-4543

Silicon Bipolar Darlington Amplifier



Data Sheet

Description

Avago Technologies' ADA-4543 is an economical, easy-to-use, general purpose silicon bipolar RFIC gain block amplifiers housed in a 4-lead SC-70 (SOT-343) surface mount plastic package which requires only half the board space of a SOT-143 package.

The Darlington feedback structure provides inherent broad bandwidth performance, resulting in useful operating frequency up to 2.5 GHz. This is an ideal device for small-signal gain cascades or IF amplification.

ADA-4543 is fabricated using Avago's HP25 silicon bipolar process, which employs a double-diffused single polysilicon process with self-aligned submicron emitter geometry. The process is capable of simultaneous high f_T and high NPN breakdown (25 GHz f_T at 6V BVCEO). The process utilizes industry standard device oxide isolation technologies and submicron aluminum multilayer interconnect to achieve superior performance, high uniformity, and proven reliability.

Surface Mount Package SOT-343

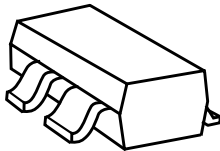

Pin Connections and Package Marking

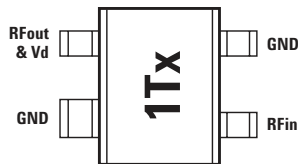

Note:

Top View. Package marking provides orientation and identification.

"1T" = Device Code

"x" = Date code character identifies month of manufacture.

Features

- Small Signal gain amplifier
- Operating frequency DC – 2.5 GHz
- Unconditionally stable
- 50 Ohms input & output
- Flat, Broadband Frequency Response up to 1 GHz
- Operating Current: 10 to 30 mA
- Industry standard SOT-343 package
- Lead-free option available

Specifications

900 MHz, 3.4V, 15 mA (typ.)

- 15.1 dB associated gain
- 1.9 dBm P_{1dB}
- 15 dBm OIP_3
- 3.7 dB noise figure
- VSWR < 2 throughput operating frequency
- Single supply, typical $I_d = 15$ mA

Applications

- Cellular/PCS/WLL base stations
- Wireless data/WLAN
- Fiber-optic systems
- ISM



Attention:

Observe precautions for handling electrostatic sensitive devices.

ESD Machine Model (Class A)

ESD Human Body Model (Class 1B)

Refer to Avago Application Note A004R: Electrostatic Discharge Damage and Control.

Typical Biasing Configuration

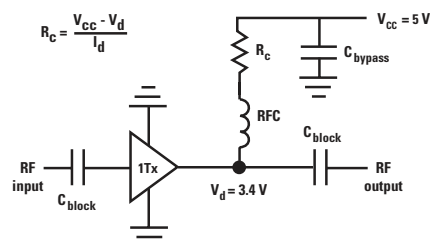

ADA-4543 Absolute Maximum Ratings^[1]

Symbol	Parameter	Units	Absolute Maximum
I_d	Device Current	mA	40
P_{diss}	Total Power Dissipation ^[2]	mW	145
$P_{in\ max.}$	RF Input Power	dBm	13
T_j	Channel Temperature	°C	150
T_{STG}	Storage Temperature	°C	-65 to 150
θ_{jc}	Thermal Resistance ^[3]	°C/W	152

Notes:

1. Operation of this device above any one of these parameters may cause permanent damage.
2. Ground lead temperature is 25°C. Derate 6.6 mW/°C for $T_L > 128^\circ\text{C}$.
3. Junction-to-case thermal resistance measured using 150°C Liquid Crystal Measurement method.

ADA-4543 Electrical Specifications

$T_A = 25^\circ\text{C}$, $Z_0 = 50\Omega$, $P_{in} = -25\ \text{dBm}$, $I_d = 15\ \text{mA}$ (unless specified otherwise)

Symbol	Parameter and Test Condition: $I_d = 15\ \text{mA}$, $Z_0 = 50\Omega$	Frequency	Units	Min.	Typ.	Max.	Std. Dev.
V_d	Device Voltage $I_d = 15\ \text{mA}$		V	3.1	3.4	3.8	
G_p	Power Gain ($ S_{21} ^2$)	100 MHz 900 MHz ^[1,2]	dB	13.5	15.7 15.1	16.5	
ΔG_p	Gain Flatness	100 to 900 MHz 0.1 to 2 GHz	dB		0.4 1.5		
F_{3dB}	3 dB Bandwidth		GHz		3.6		
$VSWR_{in}$	Input Voltage Standing Wave Ratio	0.1 to 6 GHz			1.7:1		
$VSWR_{out}$	Output Voltage Standing Wave Ratio	0.1 to 6 GHz			1.3:1		
NF	50Ω Noise Figure	100 MHz 900 MHz ^[1,2]	dB		3.6 3.7		0.16 0.18
P_{1dB}	Output Power at 1dB Gain Compression	100 MHz 900 MHz ^[1,2]	dBm		2.5 1.9		
OIP_3	Output 3 rd Order Intercept Point	100 MHz ^[3] 900 MHz ^[1,2,3]	dBm		14.6 15.0		
DV/dT	Device Voltage Temperature Coefficient		mV/°C		-5.6		

Notes:

1. Typical value determined from a sample size of 500 parts from 3 wafers.
2. Measurement obtained using production test board described in the block diagram below.
3. I) 900 MHz OIP_3 test condition: $F_1 = 900\ \text{MHz}$, $F_2 = 905\ \text{MHz}$ and $P_{in} = -25\ \text{dBm}$ per tone.
II) 100 MHz OIP_3 test condition: $F_1 = 100\ \text{MHz}$, $F_2 = 105\ \text{MHz}$ and $P_{in} = -25\ \text{dBm}$ per tone.

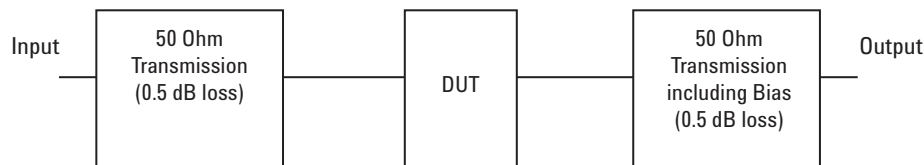

Block diagram of 900 MHz production test board used for V_d , Gain, P_{1dB} , OIP_3 , and NF measurements. Circuit losses have been de-embedded from actual measurements.

Product Consistency Distribution Charts at 900 MHz, $I_d = 15$ mA

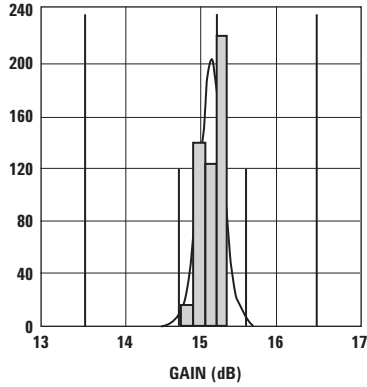

Figure 1. Gain distribution @ 15 mA.
LSL = 13.5, Nominal = 15.1, USL = 16.5

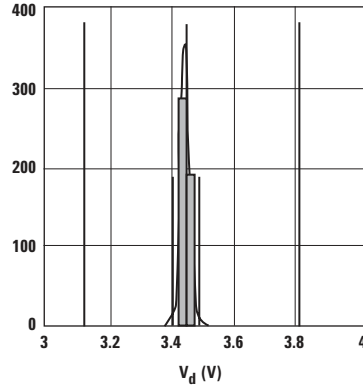

Figure 2. V_d distribution @ 15 mA.
LSL = 3.1, Nominal = 3.4, USL = 3.8

Notes:

1. Statistics distribution determined from a sample size of 500 parts taken from 3 different wafers.
2. Future wafers allocated to this product may have typical values anywhere between the minimum and maximum specification limits.

ADA-4543 Typical Performance Curves (at 25°C, unless specified otherwise)

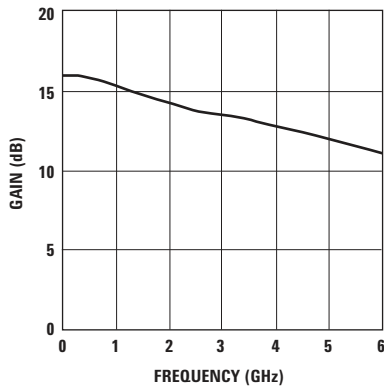

Figure 3. Gain vs. Frequency at $I_d = 15$ mA.

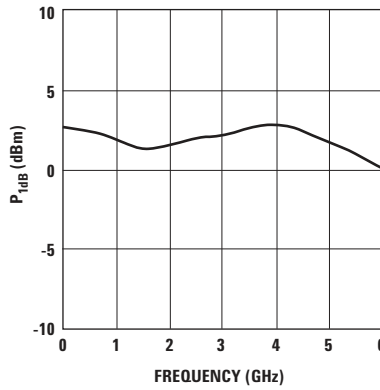

Figure 4. P_{1dB} vs. Frequency at $I_d = 15$ mA.

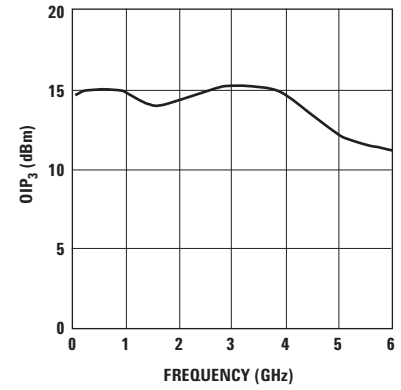

Figure 5. OIP_3 vs. Frequency at $I_d = 15$ mA.

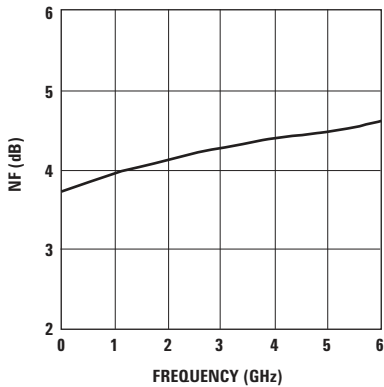

Figure 6. NF vs Frequency at $I_d = 15$ mA.

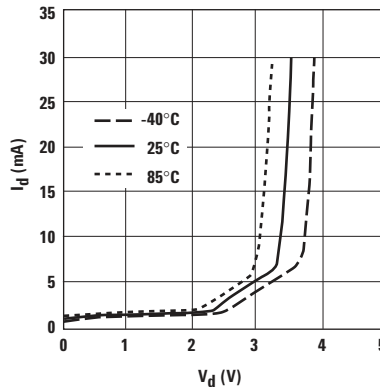

Figure 7. I_d vs. V_d and Temperature.

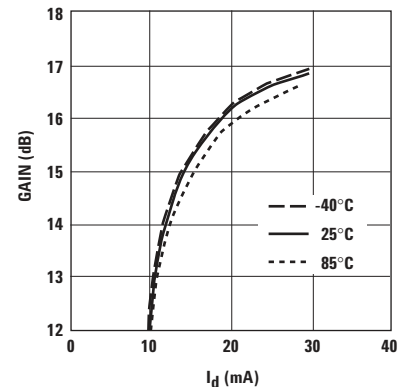

Figure 8. Gain vs. I_d and Temperature at 900 MHz.

ADA-4543 Typical Performance Curves (at 25°C, unless specified otherwise), continued

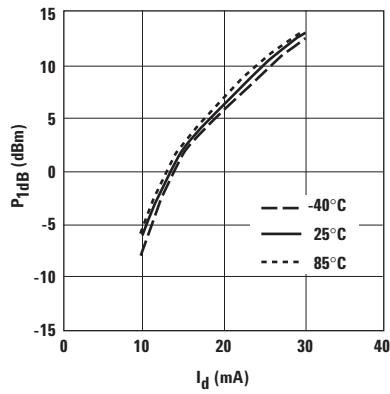

Figure 9. P_{1dB} vs. I_d and Temperature at 900 MHz.

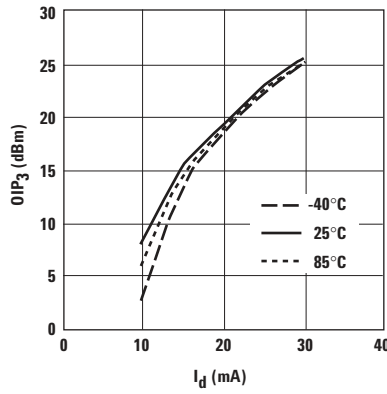

Figure 10. OIP₃ vs. I_d and Temperature at 900 MHz.

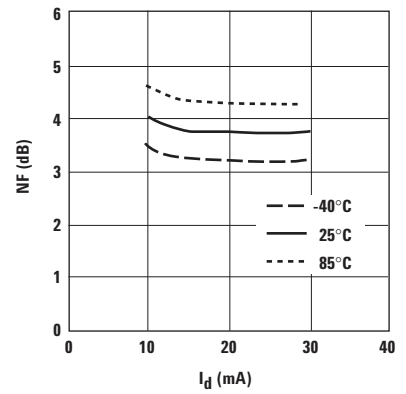

Figure 11. NF vs. I_d and Temperature at 900 MHz.

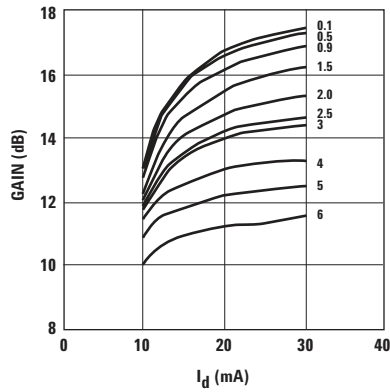

Figure 12. Gain vs. I_d and Frequency (GHz).

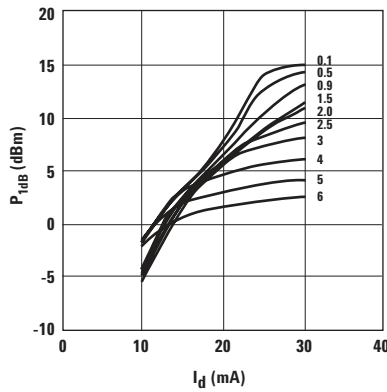

Figure 13. P_{1dB} vs. I_d and Frequency (GHz).

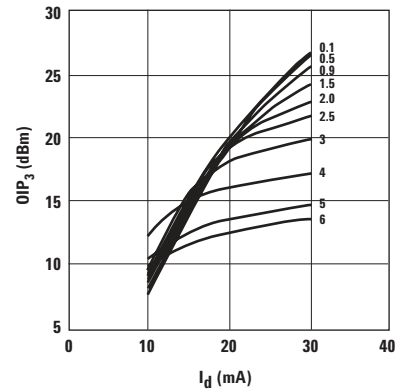

Figure 14. OIP₃ vs. I_d and Frequency (GHz).

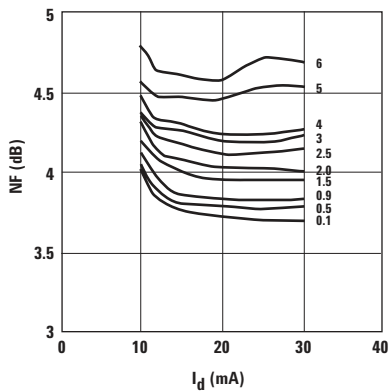

Figure 15. NF vs. I_d and Frequency (GHz).

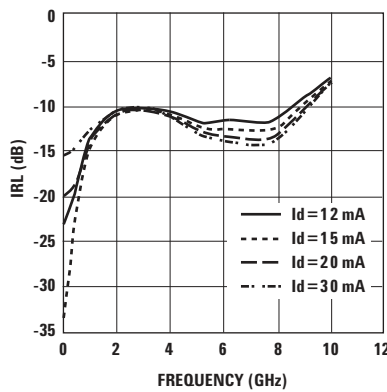

Figure 16. Input Return Loss vs. I_d and Frequency (GHz).

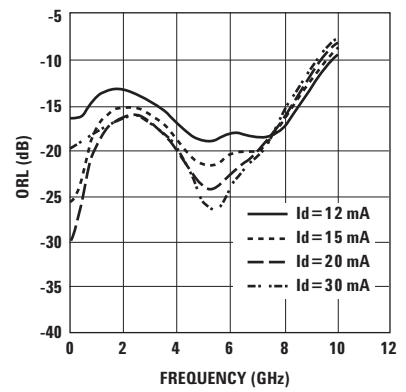

Figure 17. Output Return Loss vs. I_d and Frequency (GHz).

ADA-4543 Typical Scattering Parameters, $T_A = 25^\circ\text{C}$, $I_d = 12\text{ mA}$

Freq. GHz	S_{11}		dB	S_{21}		S_{12}		S_{22}		K
	Mag.	Ang.		Mag.	Ang.	Mag.	Ang.	Mag.	Ang.	
0.1	0.071	4.9	14.38	5.234	176.2	0.125	-0.9	0.146	-3.2	1.1
0.5	0.112	24.8	14.24	5.15	162.1	0.123	-4.6	0.15	-3.8	1.1
0.9	0.184	24.2	13.98	4.998	148.3	0.12	-7.6	0.183	-6	1.1
1.0	0.198	21.6	13.90	4.956	144.9	0.119	-8.3	0.191	-7.7	1.1
1.5	0.257	5.9	13.51	4.735	129.3	0.116	-10.9	0.207	-18.7	1.1
1.9	0.282	-4.5	13.15	4.547	117.1	0.113	-12.6	0.213	-27.2	1.2
2.0	0.29	-7.8	13.09	4.513	114.2	0.113	-13.1	0.212	-29.1	1.2
2.5	0.307	-19.4	12.72	4.326	99.8	0.111	-14.8	0.203	-38	1.2
3.0	0.31	-30.7	12.40	4.168	85.9	0.109	-16.1	0.185	-46.8	1.2
3.5	0.303	-43.3	12.07	4.013	72.2	0.109	-17.2	0.162	-57	1.3
4.0	0.287	-58	11.74	3.865	58.5	0.109	-18	0.139	-69.3	1.3
4.5	0.273	-74.8	11.45	3.736	45	0.111	-18.5	0.12	-87	1.3
5.0	0.258	-94.3	11.05	3.568	31.4	0.113	-19.2	0.11	-106.9	1.4
5.5	0.253	-116.3	10.67	3.416	18.2	0.118	-19.8	0.114	-126.3	1.4
6.0	0.259	-136.7	10.24	3.251	5	0.125	-21	0.122	-144.9	1.3
6.5	0.254	-156.4	9.83	3.101	-7.7	0.135	-22.8	0.121	-163.1	1.3
7.0	0.25	-177.8	9.43	2.961	-20.5	0.148	-26.1	0.116	173.8	1.3
7.5	0.25	157	8.97	2.81	-33.5	0.161	-31.1	0.116	143.7	1.2
8.0	0.266	131	8.45	2.645	-46.4	0.172	-37.1	0.134	111.8	1.2
8.5	0.294	106.9	7.79	2.453	-59.1	0.181	-43.2	0.171	87.5	1.2
9.0	0.346	87.1	7.17	2.284	-71	0.192	-49	0.223	71.6	1.2
9.5	0.399	70.1	6.39	2.088	-83.5	0.204	-55.7	0.281	60.3	1.1
10.0	0.454	57.4	5.73	1.935	-94.8	0.213	-62.9	0.339	50.8	1.1

Notes:

1. S-parameters are measured on a microstrip line made on 0.025 inch thick alumina carrier. The input reference plane is at the end of the input lead. The output reference plane is at the end of the output lead.

ADA-4543 Typical Scattering Parameters, $T_A = 25^\circ\text{C}$, $I_d = 15\text{ mA}$

Freq. GHz	S_{11}		dB	S_{21}		S_{12}		S_{22}		K
	Mag.	Ang.		Mag.	Ang.	Mag.	Ang.	Mag.	Ang.	
0.1	0.023	141.7	15.60	6.026	176	0.114	-0.6	0.051	-0.8	1.1
0.5	0.083	76.9	15.46	5.928	161.4	0.113	-3.2	0.068	18.9	1.1
0.9	0.165	51.8	15.20	5.753	147	0.111	-5.6	0.118	15.2	1.1
1.0	0.18	46.4	15.12	5.702	143.4	0.111	-6.2	0.129	12.3	1.1
1.5	0.238	22.4	14.63	5.389	127	0.109	-8.7	0.155	-2.1	1.1
1.9	0.265	8.8	14.19	5.12	114.3	0.108	-10.3	0.166	-12.2	1.1
2.0	0.272	5.1	14.09	5.066	111.3	0.107	-10.7	0.167	-14.2	1.1
2.5	0.292	-8.2	13.58	4.776	96.7	0.106	-12.2	0.166	-23.6	1.2
3.0	0.295	-20.7	13.13	4.532	82.8	0.105	-13.4	0.154	-32.4	1.2
3.5	0.291	-33.3	12.69	4.309	69.3	0.105	-14.3	0.135	-42	1.2
4.0	0.273	-47.8	12.28	4.112	56	0.106	-14.8	0.113	-54.4	1.3
4.5	0.256	-64.9	11.93	3.947	42.9	0.108	-15	0.092	-73.9	1.3
5.0	0.238	-84.7	11.48	3.75	29.6	0.111	-15.5	0.081	-98.8	1.3
5.5	0.23	-106.8	11.07	3.578	16.8	0.117	-15.9	0.084	-124.6	1.3
6.0	0.233	-128.8	10.63	3.399	3.9	0.125	-17.2	0.095	-148	1.3
6.5	0.229	-149.2	10.20	3.237	-8.6	0.137	-19.2	0.098	-170	1.3
7.0	0.223	-171.8	9.79	3.088	-21.2	0.151	-22.8	0.1	162.6	1.2
7.5	0.224	162	9.33	2.927	-34	0.164	-28.1	0.112	130	1.2
8.0	0.241	133.6	8.81	2.757	-46.8	0.177	-34.4	0.143	100	1.2
8.5	0.272	108.9	8.19	2.566	-59.2	0.187	-40.9	0.188	78.8	1.2
9.0	0.329	88.1	7.57	2.39	-71.1	0.199	-47.1	0.244	64.9	1.1
9.5	0.381	71.2	6.77	2.18	-83.5	0.211	-54.3	0.304	54.5	1.1
10.0	0.444	57.5	6.07	2.012	-95.2	0.22	-61.8	0.362	45.7	1.0

Notes:

1. S-parameters are measured on a microstrip line made on 0.025 inch thick alumina carrier. The input reference plane is at the end of the input lead. The output reference plane is at the end of the output lead.

ADA-4543 Typical Scattering Parameters, $T_A = 25^\circ\text{C}$, $I_d = 20\text{ mA}$

Freq. GHz	S_{11}		dB	S_{21}		S_{12}		S_{22}		K
	Mag.	Ang.		Mag.	Ang.	Mag.	Ang.	Mag.	Ang.	
0.1	0.1	168	16.54	6.714	175.9	0.104	-0.2	0.032	168.8	1.1
0.5	0.122	115	16.40	6.61	160.9	0.104	-1.8	0.052	100.8	1.1
0.9	0.188	73.6	16.16	6.427	146	0.105	-3.5	0.096	54	1.0
1.0	0.194	67.9	16.06	6.352	142.3	0.105	-4	0.104	46.9	1.0
1.5	0.244	37.8	15.50	5.955	125	0.104	-6.3	0.132	21.5	1.0
1.9	0.266	21.1	14.99	5.614	112.1	0.104	-7.9	0.145	7.7	1.1
2.0	0.273	16.9	14.87	5.537	109	0.103	-8.3	0.147	5	1.1
2.5	0.29	1.5	14.24	5.152	94.4	0.103	-9.9	0.151	-6.9	1.1
3.0	0.296	-11.5	13.69	4.838	80.6	0.102	-11	0.142	-16.6	1.2
3.5	0.288	-25.1	13.16	4.552	67.3	0.102	-11.8	0.125	-26.1	1.2
4.0	0.268	-39.4	12.71	4.319	54.4	0.103	-12.1	0.102	-38.2	1.3
4.5	0.248	-56.2	12.31	4.125	41.5	0.106	-12.2	0.077	-57.8	1.3
5.0	0.226	-75.8	11.83	3.904	28.6	0.11	-12.5	0.061	-87.1	1.3
5.5	0.214	-98.9	11.41	3.719	16	0.117	-12.9	0.062	-122.1	1.3
6.0	0.214	-121.9	10.96	3.531	3.3	0.126	-14.3	0.076	-151.9	1.3
6.5	0.209	-143	10.52	3.357	-9	0.138	-16.4	0.084	-177.5	1.3
7.0	0.204	-166.2	10.11	3.202	-21.5	0.153	-20.2	0.093	152.3	1.2
7.5	0.202	165.3	9.64	3.035	-34.2	0.167	-25.7	0.115	120.1	1.2
8.0	0.22	134.5	9.15	2.869	-47.1	0.181	-32.2	0.154	92.3	1.1
8.5	0.256	109.2	8.48	2.656	-59.3	0.192	-39	0.206	74	1.1
9.0	0.312	88.5	7.87	2.474	-71.1	0.204	-45.6	0.265	61.2	1.1
9.5	0.368	71.2	7.11	2.266	-83.4	0.217	-53.1	0.327	51.2	1.1
10.0	0.432	57.1	6.37	2.082	-95.1	0.227	-60.9	0.386	42.6	1.0

Notes:

1. S-parameters are measured on a microstrip line made on 0.025 inch thick alumina carrier. The input reference plane is at the end of the input lead. The output reference plane is at the end of the output lead.

ADA-4543 Typical Scattering Parameters, $T_A = 25^\circ\text{C}$, $I_d = 30\text{ mA}$

Freq. GHz	S_{11}			S_{21}			S_{12}		S_{22}		K
	Mag.	Ang.	dB	Mag.	Ang.	Mag.	Ang.	Mag.	Ang.		
0.1	0.17	171.3	17.29	7.32	175.8	0.096	0.1	0.105	173.1	1.1	
0.5	0.179	129.9	17.15	7.206	160.6	0.097	-0.3	0.108	133.8	1.0	
0.9	0.223	89.4	16.92	7.017	145.3	0.099	-1.3	0.12	87.2	1.0	
1.0	0.226	82.7	16.82	6.931	141.5	0.099	-1.7	0.123	78.5	1.0	
1.5	0.257	48.6	16.19	6.449	123.5	0.1	-3.9	0.137	45.2	1.0	
1.9	0.277	30.9	15.61	6.035	110.5	0.1	-5.6	0.147	27.3	1.0	
2.0	0.283	26.4	15.48	5.941	107.4	0.1	-6	0.15	23.6	1.0	
2.5	0.298	9.4	14.77	5.478	92.7	0.1	-7.7	0.153	8.6	1.1	
3.0	0.299	-4.6	14.14	5.095	79.1	0.1	-8.9	0.145	-2.7	1.1	
3.5	0.289	-18.1	13.56	4.766	65.9	0.101	-9.6	0.128	-12.6	1.2	
4.0	0.266	-32.3	13.07	4.502	53.3	0.102	-9.9	0.104	-24	1.2	
4.5	0.244	-49	12.64	4.284	40.6	0.105	-9.9	0.074	-41.4	1.3	
5.0	0.22	-68.7	12.14	4.048	27.9	0.109	-10.2	0.051	-71	1.3	
5.5	0.204	-91.9	11.70	3.848	15.5	0.116	-10.5	0.047	-116	1.3	
6.0	0.201	-115.7	11.25	3.651	2.9	0.126	-12	0.062	-154.1	1.3	
6.5	0.196	-137.6	10.80	3.468	-9.3	0.139	-14.3	0.075	176.7	1.2	
7.0	0.188	-162.3	10.38	3.305	-21.6	0.154	-18.2	0.091	145.3	1.2	
7.5	0.189	167.9	9.93	3.137	-34.2	0.17	-23.8	0.12	114.5	1.1	
8.0	0.205	135.4	9.43	2.962	-47	0.184	-30.6	0.165	88.8	1.1	
8.5	0.24	109.5	8.75	2.739	-59.3	0.196	-37.6	0.221	71.7	1.1	
9.0	0.303	88.3	8.17	2.561	-71	0.208	-44.3	0.282	59.4	1.1	
9.5	0.361	70.9	7.38	2.339	-83.4	0.221	-52	0.345	49.6	1.0	
10.0	0.429	57.2	6.69	2.161	-94.8	0.231	-60	0.405	40.9	1.0	

Notes:

1. S-parameters are measured on a microstrip line made on 0.025 inch thick alumina carrier. The input reference plane is at the end of the input lead. The output reference plane is at the end of the output lead.

Ordering Information

Part Number	No. of Devices	Container
ADA-4543-TR1	3000	7" Reel
ADA-4543-TR2	10000	13" Reel
ADA-4543-BLK	100	antistatic bag
ADA-4543-TR1G	3000	7" Reel
ADA-4543-TR2G	10000	13" Reel
ADA-4543-BLKG	100	antistatic bag

Note: For lead-free option, the part number will have the character "G" at the end.

Package Dimensions Outline 43 SOT-343 (SC70 4-lead)

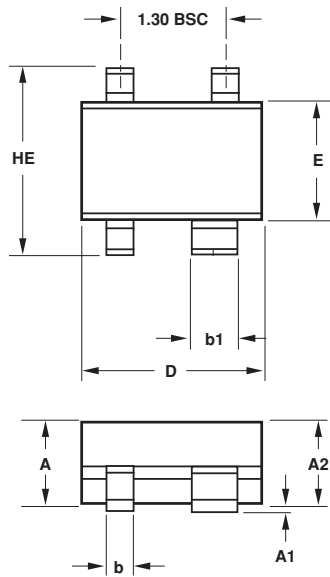

SYMBOL	DIMENSIONS (mm)	
	MIN.	MAX.
E	1.15	1.35
D	1.85	2.25
HE	1.80	2.40
A	0.80	1.10
A2	0.80	1.00
A1	0.00	0.10
b	0.25	0.40
b1	0.55	0.70
c	0.10	0.20
L	0.10	0.46

NOTES:

1. All dimensions are in mm.
2. Dimensions are inclusive of plating.
3. Dimensions are exclusive of mold flash & metal burr.
4. All specifications comply to EIAJ SC70.
5. Die is facing up for mold and facing down for trim/form, ie: reverse trim/form.
6. Package surface to be mirror finish.

Recommended PCB Pad Layout for Avago's SC70 4L/SOT-343 Products

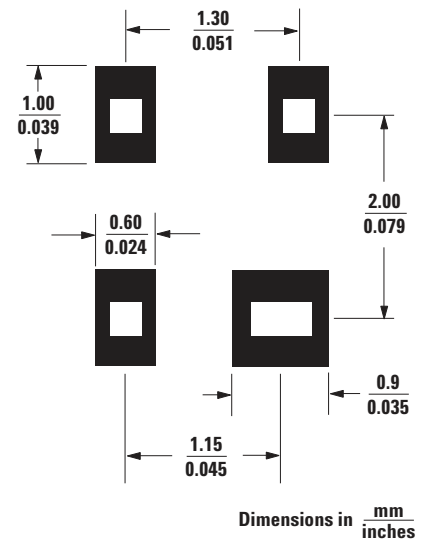

Device Orientation

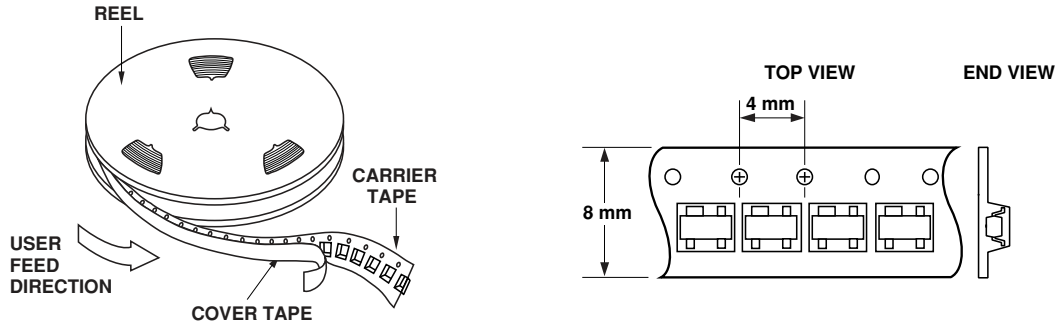

Tape Dimensions For Outline 4T

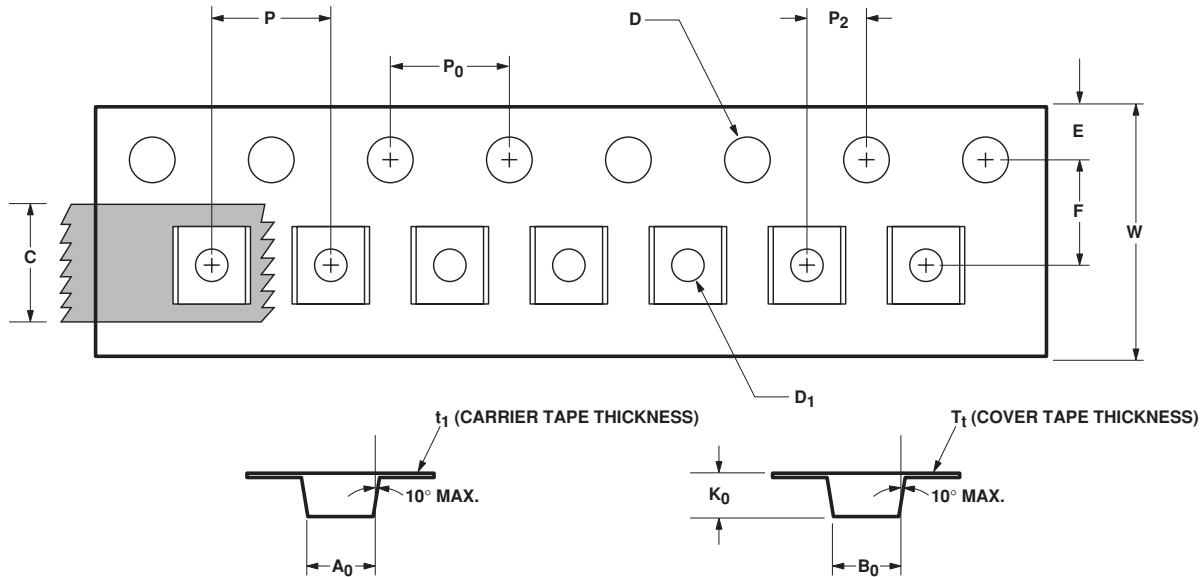

DESCRIPTION		SYMBOL	SIZE (mm)	SIZE (INCHES)
CAVITY	LENGTH	A ₀	2.40 ± 0.10	0.094 ± 0.004
	WIDTH	B ₀	2.40 ± 0.10	0.094 ± 0.004
	DEPTH	K ₀	1.20 ± 0.10	0.047 ± 0.004
	PITCH	P	4.00 ± 0.10	0.157 ± 0.004
	BOTTOM HOLE DIAMETER	D ₁	1.00 ± 0.25	0.039 ± 0.010
PERFORATION	DIAMETER	D	1.50 ± 0.10	0.061 ± 0.002
	PITCH	P ₀	4.00 ± 0.10	0.157 ± 0.004
	POSITION	E	1.75 ± 0.10	0.069 ± 0.004
CARRIER TAPE	WIDTH	W	8.00 ± 0.30 - 0.10	0.315 ± 0.012
	THICKNESS	t ₁	0.254 ± 0.02	0.0100 ± 0.0008
COVER TAPE	WIDTH	C	5.40 ± 0.10	0.205 ± 0.004
	TAPE THICKNESS	T _t	0.062 ± 0.001	0.0025 ± 0.0004
DISTANCE	CAVITY TO PERFORATION (WIDTH DIRECTION)	F	3.50 ± 0.05	0.138 ± 0.002
	CAVITY TO PERFORATION (LENGTH DIRECTION)	P ₂	2.00 ± 0.05	0.079 ± 0.002

For product information and a complete list of distributors, please go to our web site:
www.avagotech.com

Avago, Avago Technologies, and the A logo are trademarks of Avago Technologies, Limited in the United States and other countries.
 Data subject to change. Copyright © 2006 Avago Technologies, Limited. All rights reserved.
 Obsoletes 5989-1974EN
 5989-3752EN April 17, 2006

Avago
 TECHNOLOGIES