

NAIS

HALF SIZE Amber RELAY

R-RELAYS

UL File No.: E43149 CSA File No.: LR26550

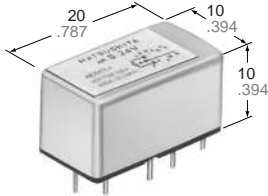

mm inch

- Amber sealed construction for automatic wave soldering and cleaning
- Latching types available
- High sensitivity — TTL direct drive possible
- High speed — Up to 500 cycle/sec. operations
- Wide switching range and high welding resistance
- Gold cobalt (AuCo) contact permits
 - Wider switching range from low level up to high current: 10 μ A to 1 A
 - Higher sticking resistance to inrush current
 - Stable contact resistance from initial stage throughout life

SPECIFICATIONS

Contact

Arrangement		1 Form C	
Initial contact resistance, max. (By voltage drop 6 V DC 1 A)		60 m Ω	
Initial contact pressure		Approx. 5 g .18 oz	
Contact material		Gold cobalt	
Electrostatic capacitance	Contact-Contact	Sealed type	3 pF
		Magnetically sealed type	4 pF
	N.O. contact-coil	Sealed type	4 pF
		Magnetically sealed type	5 pF
	N.C. contact-coil	Sealed type	5 pF
		Magnetically sealed type	6 pF
Nominal switching capacity		1A 20 VDC, 0.3A 110 VAC	
Rating (resistive)	Max. switching power		33 VA, 20 W
	Max. switching voltage		110 V AC, 30 V DC
	Max. switching current		AC 0.3 A, DC 1 A
	Min. switching power		Approx. 100 mV 10 μ A
UL/CSA rating		0.3 A 125 V AC, 1 A 30 V DC	
Expected life (min. operations)	Mechanical (at 500 cps.)		10 ⁹
	Electrical (resistive)	1 A 20 V DC/0.3 A 110 V AC	10 ⁶ (at 1 cps.)
		0.5 A 30 V DC/0.1 A 110 V AC	3 \times 10 ⁶ (at 2 cps.)
		0.25 A 30 V DC/0.25 A 30 V AC	5 \times 10 ⁶ (at 5 cps.)
		0.2 A 24 V DC/0.2 A 24 V AC	10 ⁷ (at 25 cps.)
		0.1 A 12 V DC/0.1 A 12 V AC	5 \times 10 ⁷ (at 50 cps.)
0.1 A 9 V DC/0.1 A 9 V AC	10 ⁸ (at 100 cps.)		

Remarks

- *1 Measurement at same location as "Initial breakdown voltage" section
 *2 Min. 500M Ω at 100 VDC between coils of 2 coil latching type
 *3 Detection current: 10mA, Except for between coils of 2 coil latching type
 *4 Excluding contact bounce time
 *5 Half-wave pulse of sine wave: 6ms; detection time: 10 μ s
 *6 Half-wave pulse of sine wave: 6ms
 *7 Detection time: 10 μ s
 *8 Although R relays are rated at 10 G/55 cps. vibration resistance, they will withstand up to 60 G/2,000 cps., provided they receive additional support such as anchoring to the PC board with epoxy resin.
 *9 Refer to 5. Conditions for operation, transport and storage mentioned in AMBIENT ENVIRONMENT (Page 49)

Coil (polarized) (at 25°C 77°F)

Minimum operating power	Single side stable	72 to 133 mW
	1 coil latching	41 to 45 mW
	2 coil latching	72 to 107 mW
Nominal operating power	Single side stable	147 to 300 mW
	1 coil latching	74 to 153 mW
	2 coil latching	147 to 331 mW

Characteristics (at 25°C 77°F)

Max. operating speed		500 cps. (mechanical)
Initial insulation resistance*1		Min. 1000 M Ω at 500 V DC*2
Initial breakdown voltage*3	Between live parts and ground	1,000 Vrms
	Between open contact	350 Vrms (500 V DC)
	Between contact and coil	1,000 Vrms
Operate time*4 (at nominal voltage)		Max. 3 ms (Approx. 1 ms)
Release time(without diode)*4 (at nominal voltage)		Max. 2 ms (Approx. 0.5 ms)
Contact bounce time	Single side stable	Approx. 0.5 ms
	1-coil /2-coil latching	Approx. 0.3 ms
Temperature rise		Max. 35°C at 0.5 W operating power Max. 65°C at 1 W operating power
Shock resistance	Functional*5	Min. 980 m/s ² {100 G}
	Destructive*6	Min. 980 m/s ² {100 G}
Vibration resistance	Functional*7	98 m/s ² {10 G}, 10 to 55 Hz at double amplitude of 1.6 mm*8
	Destructive	117.6 m/s ² {12 G}, 10 to 55 Hz at double amplitude of 2 mm
Conditions for operation, transport and storage*9 (Not freezing and condensing at low temperature)		Ambient temp.
		-55°C to +65°C*10 -67°F to +149°F
Unit weight		Humidity
		5 to 85% R.H.
Unit weight		Approx. 7 g .25 oz

*10 Total temperature (ambient temperature plus temperature rise in coil) should not exceed 90°C 194°F for single side stable, and 105°C 221°F for latching relays. See Reference Data for determination of coil voltage versus temperature.

TYPICAL APPLICATIONS

Telecommunications equipment, alarm devices, machine tools, NC machines, automatic warehouse control, conveyors, air-conditioners, pressing machines,

textile machinery, elevators, control panels, pin-board programmers, parking meters, industrial robots, detectors, annunciators, optical instruments,

business machines, time recorders, cash registers, copiers, vending machines, medical equipment.

ORDERING INFORMATION

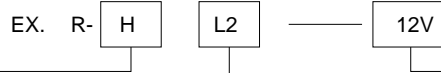

Types of case
H: Sealed S: Magnetically sealed

Operating function
Nil: Single side stable L: 1 coil latching L2: 2 coil latching

Coil voltage (DC)
5, 6, 12, 24, 42 V

- (Notes) 1. Power types and 1 Form A types are available on request.
 2. For UL/CSA recognized types, delete "N" at head portion of part No. and add suffix UL/CSA, when ordering. Ex. RSD-12V UL/CSA
 3. Standard packing Carton: 50 pcs., Case: 500 pcs.

TYPES AND COIL DATA at 25°C 77°F

Single side stable (R-SD)

Nominal coil voltage, V DC	Pick-up voltage, V DC (max.)	Drop-out voltage, V DC (min.)	Maximum allowable voltage, V DC (40°C)	Coil resistance, Ω (±10%)	Nominal operating power, mW	Inductance, Henrys
5	3.5	0.5	13	170	147	0.050
6	4.7	0.6	14	220	164	0.075
12	9.3	1.2	28	890	162	0.3
24	16	2.4	42	2,000	288	0.66
42	28	4.2	85	8,000	221	2.7

1 coil latching (R-SLD)

Nominal coil voltage, V DC	Pick-up voltage, V DC (max.)	Maximum allowable voltage, V DC (40°C)	Coil resistance, Ω (±10%)	Nominal operating power, mW	Inductance, Henrys
5	3.5	18	340	74	0.12
6	4.3	20	450	80	0.16
12	8.0	30	1,500	96	0.66
24	17	75	6,000	96	2.4
42	23	110	12,000	147	3.9

2 coil latching (R-SL2D)

Nominal coil voltage, V DC	Pick-up voltage, V DC (max.)	Maximum allowable voltage, V DC (40°C)	Coil resistance, Ω (±10%)		Nominal operating power, mW	Inductance, Henrys
			Set coil	Reset coil		
5	3.5	13.0	170	170	147	0.024
6	4.3	14.0	225	225	160	0.04
12	8.0	26.0	650	650	230	0.14
24	17.0	50.0	2,700	2,700	213	0.35
42	23.0	75.0	5,500	5,500	321	0.8

- (Notes) 1. Maximum allowable operating power: 1000 mW at 25°C 77°F.
 2. Change rate of pick-up voltage vs. temperature is described in Data on page 157.

DIMENSIONS

mm inch

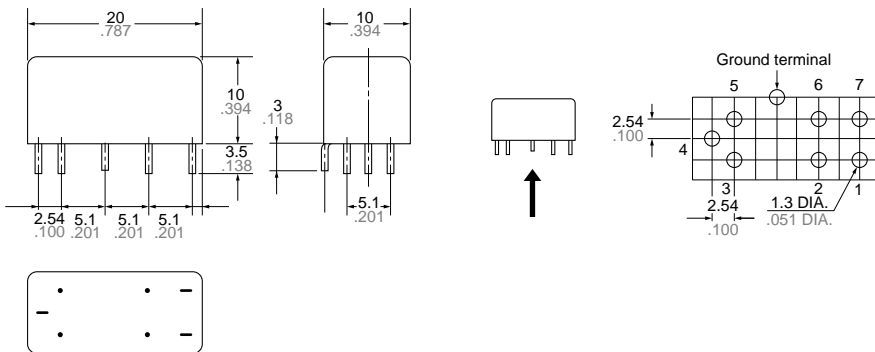

Terminal dimensions (Except soldering)

Terminal No.	Thickness	Width
1, 7	0.5 .020	0.6 .024
4	0.3 .012	0.7 .028
2, 3, 5, 6, ground terminal	0.5 DIA. .020 DIA.	

Soldering: 0.3 .012 max.

General tolerance: ±0.5 ±.020

Tolerance: ±0.2 ±.008

SCHEMATIC

1. Single side stable (2, 6: free terminals)

Same operation as the conventional magnetic relays.
 (a) During deenergization, terminals **No. 4 (COM)** and **No. 1 (N.C.)** are on "make".



(b) During energization with the indicated polarity, terminals **No. 4** and **No. 7 (N.O.)** are on "make".

Note:
 Energization with an opposite polarity does not switch the contact. Apply proper polarity to switch the contact.

2. Latching type

Once energized, the **COM** contact is kept under the same condition without further energizing continuously.

To switch over the contact, energy with an opposite polarity should be applied to the coil.

1 coil latching (2, 6: free terminals)

(a) When terminals **No. 5 (-)** and **No. 3 (+)** are energized, terminals **No. 4** and **No. 7** are switched to "make". (or stay on "make"). when the coil current is switched off, terminals **No. 4** and **No. 7** are held on "make".

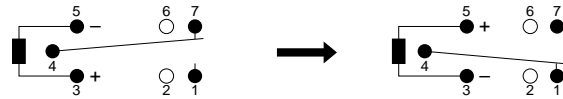

(b) When energized with reverse polarity terminals **No. 4** and **No. 1** are switched to "make" and held on "make" until energized again with an opposite polarity.

2 coil latching

(a) When terminals **No. 5 (+)** and **No. 6 (-)** or terminals **No. 3 (+)** and **No. 2 (-)** are energized terminals **No. 4** and **No. 7** are switched to "make". (or remain on "make"). When the coil current is switched off, these terminals are held on "make".

(b) When terminals **No. 5 (-)** and **No. 6 (+)** or terminals **No. 3 (-)** and **No. 2(+)** are energized in the reverse of condition (a), terminals **No. 4** and **No. 1** are switched to "make" and held on "make" until energized in an opposite polarity once again.

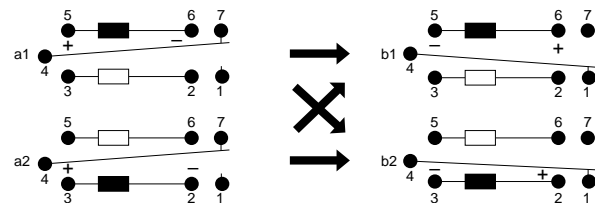

Special use of 2 coil latching

2 coil latching can be used in the same manner as 1 coil latching by shorting **No. 5** and **No. 2** or **No. 3** and **No. 6**

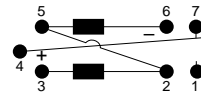

1. The latching type of R relay can be used as the memory element to be operated by a pulse supplied from one or two different sources.

2. With the 2 coil latching type, when simultaneously applying one polarity to one coil and the opposite polarity to the other, the previously energized coil will take priority of operation and will maintain the contact condition.

3. In practical use, switching either from **a1** to **b2** or from **a2** to **b1** is recommendable.

DIFFERENCES BETWEEN R RELAYS AND REED RELAYS

	R relays	Reed relays
Structure		
Contact arrangement	1 Form C	1 Form A or 1 Form B
Contact capacity	20 W (high contact pressure)	5 to 15 W
Operating function	Single side stable Latching	Single side stable
"Getter" hole	Yes	No

"Getter" holes are formed on both pole shoes to obtain uniform contact resistance throughout life. Film-forming phenomena on contacts is thus fully prevented.

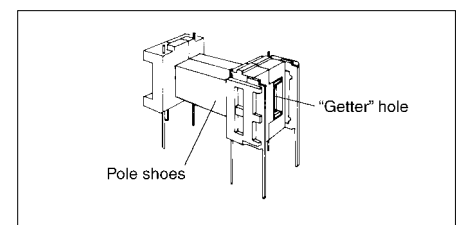

REFERENCE DATA

1.-(1) Contact reliability

Test sample: R-SD-24V 54 pcs.

Circuits: (A) Following figure with diode

(B) Following figure without diode

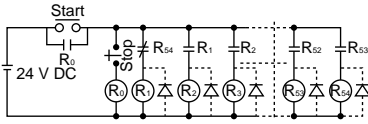

Item to be checked: Detect with the circuit stopped

Circuits:

(A) Diode provided: The circuit does not stop throughout 100 million times.

(B) Diode not provided: $\lambda_{60} = 2.5 \times 10^{-8}$ times

1.-(2) Contact reliability

TEST CONDITION

Sample: R-SD-24V, 10 pcs.

Contact voltage: 100 mV

Contact current: 10 μ A

Cycle rate: 50 cps.

Detection level: 100 Ω

Testing operation: 3×10^7

$m = 1.9$ $\sigma = 2.5 \times 10^7$

$\mu = 4.7 \times 10^7$ 95% reliability limit: 1.15×10^7

(Mean time between failure)

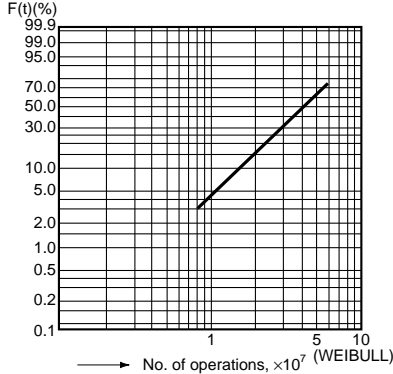

2. Coil temperature rise (under saturated condition)

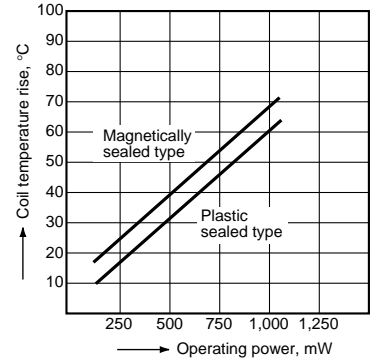

3.-(1) Operate time including bounce time (Single side stable)

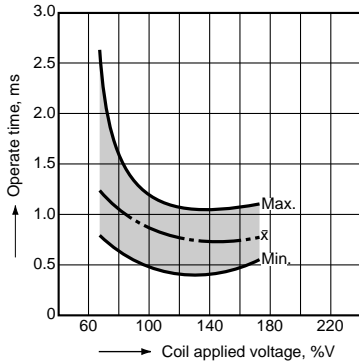

3.-(2) Operate time including bounce time (2 coil latching)

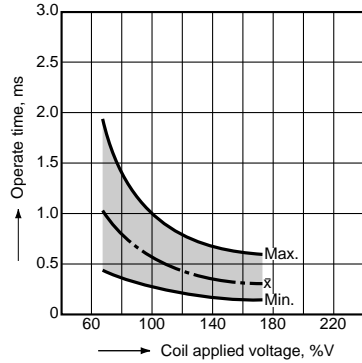

4. Release time including bounce time (Single side stable)

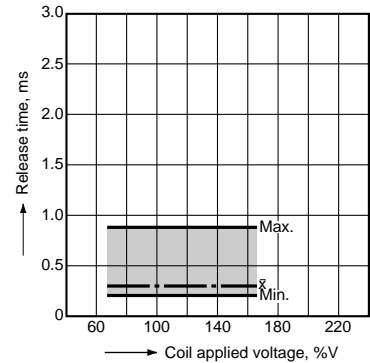

5.-(1) Leaving at high temperature (Change of pick-up and drop-out voltages)

Tested sample: R-SD-24V, 30 pcs.

Condition: Deenergized leaving at 90°C 194°F (constant temperature)

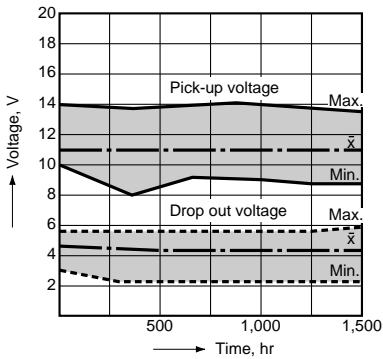

5.-(2) Leaving at high temperature (Change of contact resistance)

Tested sample: R-SD-24V, 30 pcs.

Condition: Deenergized leaving at 90°C 194°F (constant temperature)

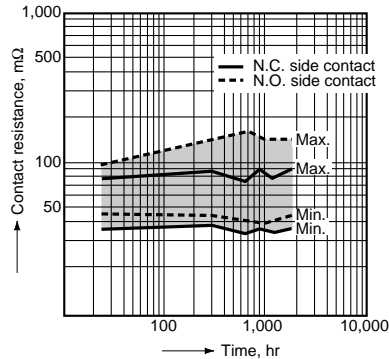

6. High frequency characteristics

Tested sample: R-SD-24V

Tested condition:

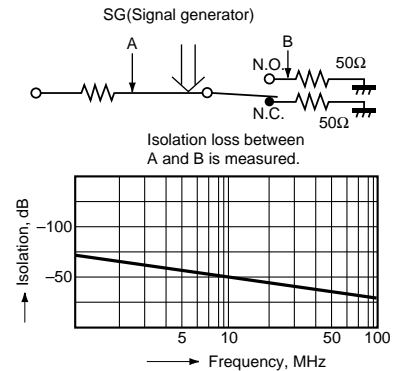

7. Contact sticking resistance

TEST CONDITION

The purpose of this test was to confirm contact sticking resistance and contact stability against coil ripples.

Tested Sample: R-SD-24V, 10 pcs.

Test method: Following coil ripples were applied.

Test period: 500 hours

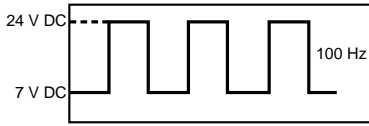

TEST RESULT

No occurrence of sticking was observed.

Contact resistance: Fig. 1

R-SD-24V: 29 mΩ to 30.4 mΩ

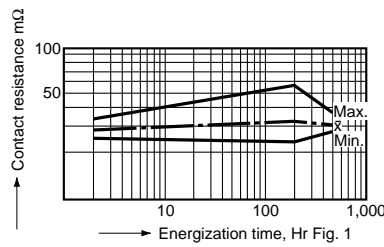

In actual application, above coil ripples should be avoided and use of a capacitor in the circuit is recommended to keep the ripple factor below 5%.

8. Distribution of contact resistance

Tested sample: R-SD-24V (WG type) 105 pcs.

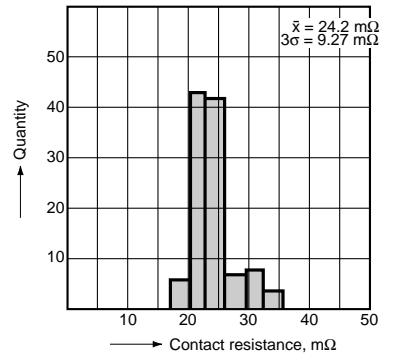

9.-(1) Rate of change in pick-up and drop-out voltage (Single side stable)

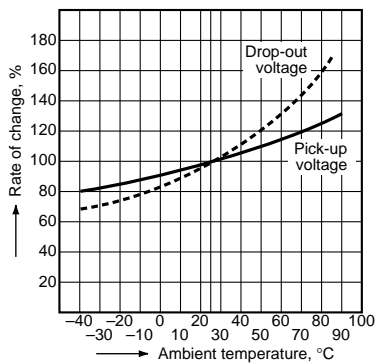

9.-(2) Rate of change in pick-up voltage (2 coil latching)

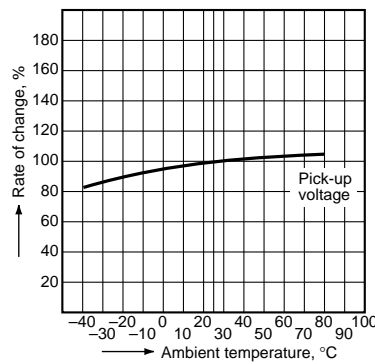

10.-(1) Mechanical life

(Change of pick-up and drop-out V)

Tested Sample: R-SD-24V, 10 pcs.

Operation frequency: 500 cps

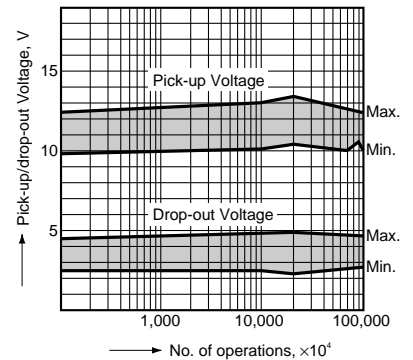

10.-(2) Mechanical life

(Change of contact resistance)

Tested Sample: R-SD-24V, 10 pcs.

Operation frequency: 500 cps

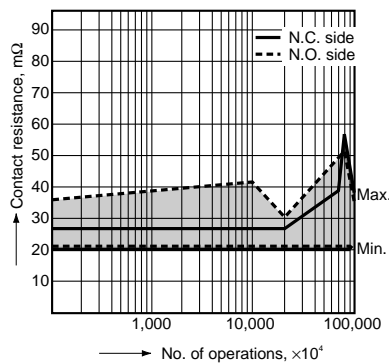

11.-(1) Electrical life

(1 A 20 V DC resistive load)

Tested sample: R-SD-24V, 10 pcs.

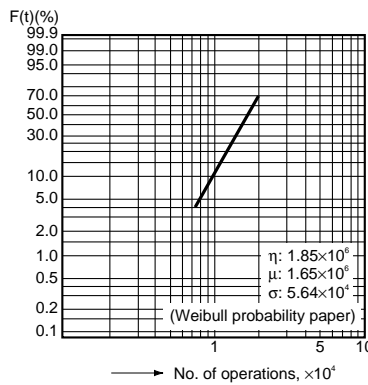

11.-(2) Electrical life

Tested Sample: R-SD-24V, 10 pcs.

Load: 60 mA 24 V DC resistive load

Frequency: 50 cps

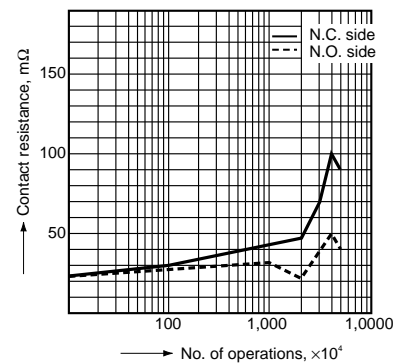

11.-(3) Electrical life

Tested Sample: R-SD-12V, 10 pcs.

Load: 54 mA 12 V DC inductive load

with diode protection

(4 relay coils in parallel of NR-SD-12V)

Frequency: 50 cps

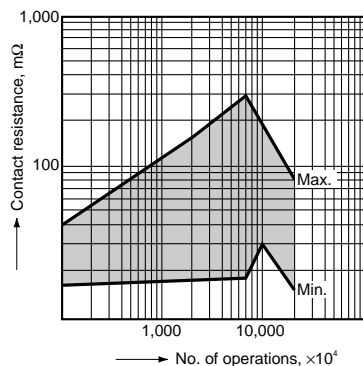

11.-(4) Electrical life

(327 mA 24 V DC relay coil load)

Tested sample: R-SD-24V, 5 pcs.

Condition: HP2-DC24x6 pcs. in parallel,

diode protector provided

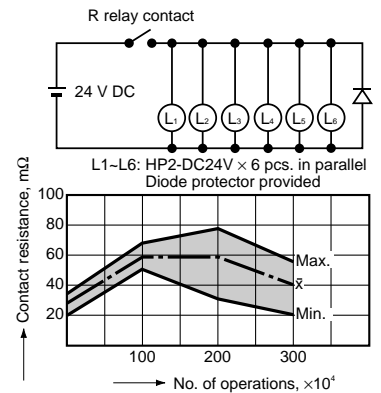
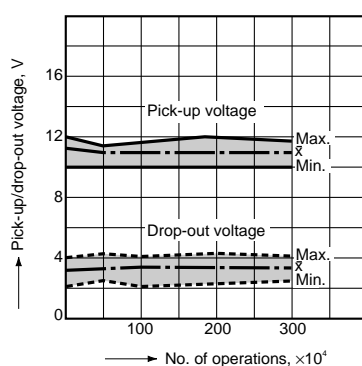

R

12. Thermal electro motive force
 Tested Sample: R-SD-12V, 5 pcs.
 Coil applied V: 12 V DC
 Ambient atmosphere: 25°C, 60% RH

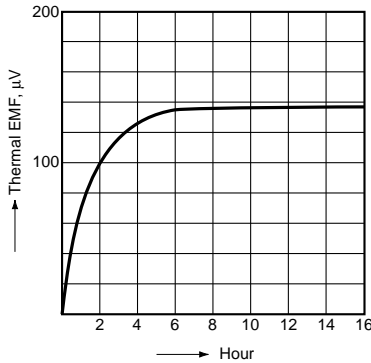

13. High temperature test
TEST CONDITION
 Tested Sample: R-SD-24V, 30 pcs.
 Ambient temperature: 80°C
 Humidity: less than 50% R.H.
 Exposure time: 2,000 hours with relays deenergized.
TEST RESULT
 Contact resistance: Fig. 1
 All samples were measured less than 100 mΩ in contact resistance throughout this test.

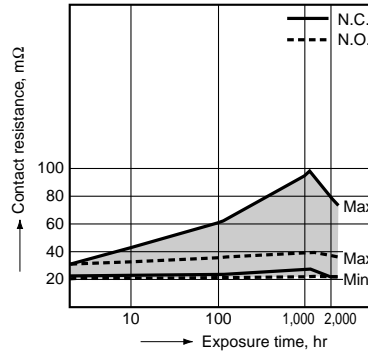

14. Influence of adjacent mounting

Distance (mm) (inch)	0 (0)	5 (.197)	10 (.394)	15 (.591)
Type				
Magnetically shielded type	±5%	±1%	0	0
Sealed type	—	±10%	±6%	±2%

15. Resistive load test
TEST CONDITION
 Tested Sample: R-SD-24V, 10 pcs.
 Load: 1 A 20 V DC Resistive
 Cycle rate: 1.4 cps.
 Contact resistance in life test

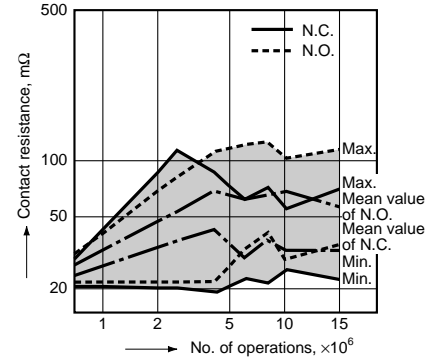

APPLICATION HINTS

Contact protection circuit

When using R relays in inductive load circuits, a contact protection circuit is recommended.

Examples:

CR	CR	Diode
<p>1. $r =$ more than 20 to 30 ohms 2. In an AC circuit impedance of L is to be somewhat smaller than impedance of r and c.</p>	<p>Can be used for both AC and DC circuits. Use 500 to 1000 ohms for r and 0.1 μF to 0.2 μF 200 V for c in a general 12 to 24 V load circuit.</p>	<p>For DC circuits only.</p>

The following is life data under our HP2 relay load.

Contact voltage	Contact current	Contact protection circuit	Operating speed	Expected life, min. op.
6 V DC	232 mA	0.2 μ F + 1k Ω or diode	2 op./s	3 \times 10 ⁷
12 V DC	106 mA	0.2 μ F + 1k Ω or diode	2 op./s	3 \times 10 ⁷
24 V DC	54 mA	0.1 μ F + 1k Ω or diode	2 op./s	3 \times 10 ⁷
100 V DC	15 mA	0.1 μ F + 1k Ω or diode	2 op./s	2 \times 10 ⁷
24 V DC	80 mA	0.2 μ F + 1k Ω	2 op./s	3 \times 10 ⁷
100 V DC	20 mA	0.1 μ F + 1k Ω or varistor	2 op./s	2 \times 10 ⁷
200 V DC	10 mA	0.1 μ F + 1k Ω	2 op./s	2 \times 10 ⁷

(Notes)

- When inrush current occurs in the capacitor load circuit or incandescent lamp load circuit, reduce it to less than 5 A. Electrical life of "AuCo" contact types is 10,000 operations in a 5 A inrush current circuit.
- When 5 A to 10 A inrush current occurs in the capacitor load circuit or incandescent lamp load circuit, the use of power types is recommended.

2 coil latching types

A) The circuit at right is recommended when using one coil for latching and the other coil for reset.

R relays are sensitive enough to be operated by the discharge of energy accumulated in the inner-coil capacitance. The use of a diode of over 200 V breakdown will prevent misoperation from this source.

In order to maintain the insulation between the two coils, connection of the terminal No. 3 and No. 6 or the terminal No. 2 and No. 5 is recommended, as shown in the right figure. Rectifiers should be inserted in this circuit when the nominal coil voltage of the R relay is more than 24 V DC.

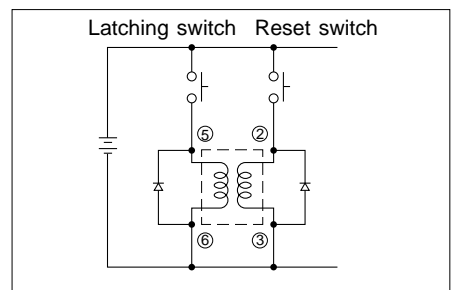

B) No damage will occur to the coil of either the one or two coil bistable types even if the operating voltage is as much as 2 or 3 times the nominal coil voltage.

C) If separate pulses are applied to each coil of the 2 coil bistable types, the first pulse will operate when the pulses are of equal voltage. When voltages differ the higher voltage will cause operation provided the voltage difference is greater than the measured pick-up voltage. Voltage difference on the coils will reduce contact pressure proportionately.

Continuous bias voltage after an operating pulse lowers contact pressure and vibration resistance.

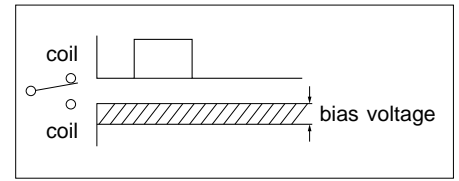

Ripple factor

Coils should be operated on pure DC. Rectified AC may cause changes in the

pick-up/drop-out characteristics because of the ripple factor. Use of a capacitor in

the circuit is recommended to keep the ripple factor below 5%.

To calculate the ripple factor

$$\text{Ripple factor (\%)} = \frac{E_{\text{max.}} - E_{\text{min.}}}{E_{\text{mean}}} \times 100\%$$

E max. = max. value of pulsating component
 E min. = min. value of pulsating component
 E mean = average value DC component

When designing R relay circuits

Care should be taken when designing relay circuits since the response of the relay is so fast that bouncing or chattering from conventional relays in the circuit may cause false operation.

When using long lead wires

When long wires (as long as 100 m or more) are to be used, the use of resistance (10 to 50 Ω) in series with the contact is required in order to eliminate the effect of the possible inrush current due to the stray capacitance existing between the two wires or between the wire and ground.

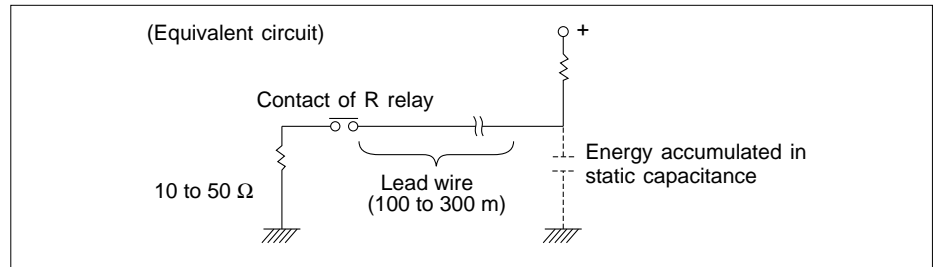

AC operation of latching relays

When using circuits such as those at the right, avoid continued or extended latching or resetting power input.

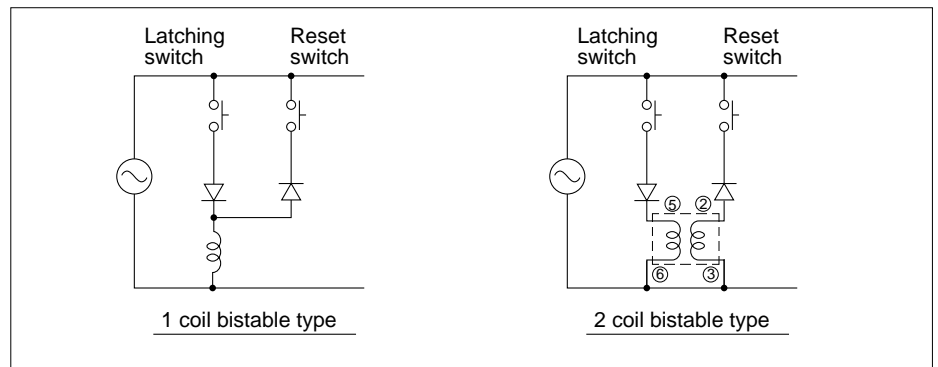

Capacitor discharge operation of latching types

When operating bistable (latching) types by discharge of a capacitor, more reliable operation can be expected if the time to reach pick-up voltage is greater than 2 ms at 5 to 10 μF: (24 V type).

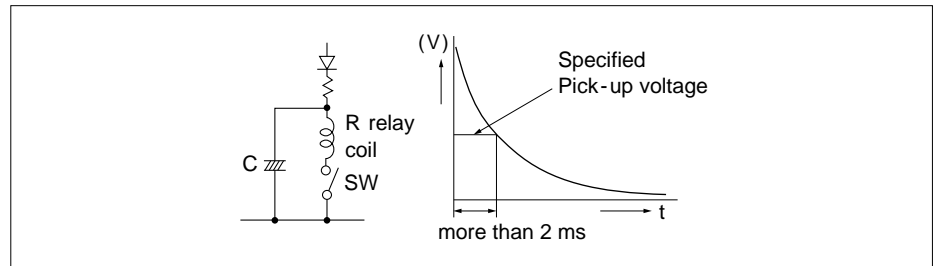

R

Automatic coil circuit interruption

Misoperation may occur in self-operated cutoff circuits such as shown at right. This can be avoided by adding a resistor and capacitor and increasing the pick-up voltage to above that specified. In a timer circuit, step-pulse voltage from PUT (Programmable Unijunction Transistor) or SBS (Silicon Bilateral Switch) is recommended.

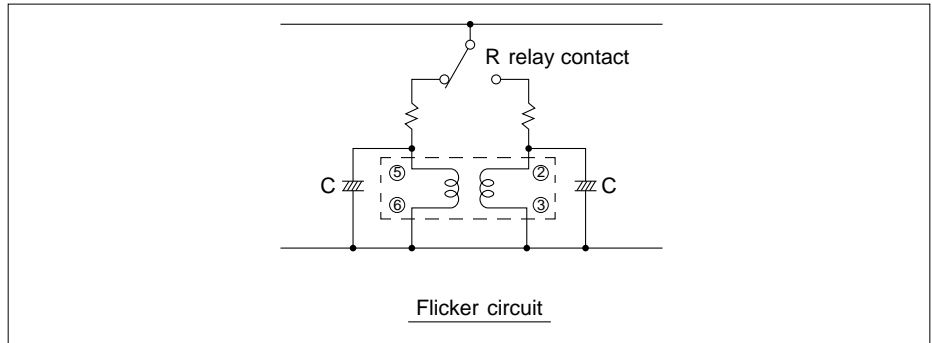
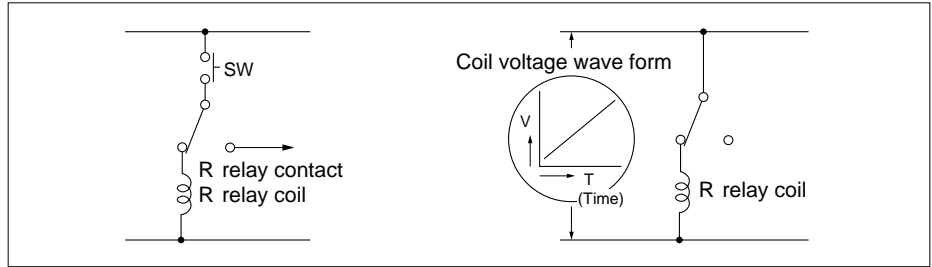

Residual voltage

When single side stable types or latching types are driven by transistor or UJT, residual voltage is sometimes applied to the coils and decreases contact pressure at N.O. side even if the transistor or UJT are in OFF condition. As a result, characteristics of relays may be harmed. Design your circuits in principle to make such residual voltage zero.

Short circuit prevention between N.C. and N.O.

The separation of loads or insertion of a resistor for circuit protection are recommended for the circuits where large current flows due to arcing. (See Fig. 1).

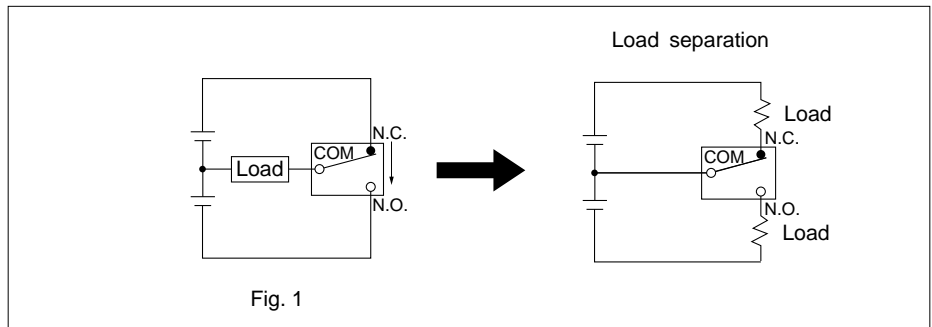

ACCESSORIES

PC board terminal sockets (with hold-down clip)

mm inch

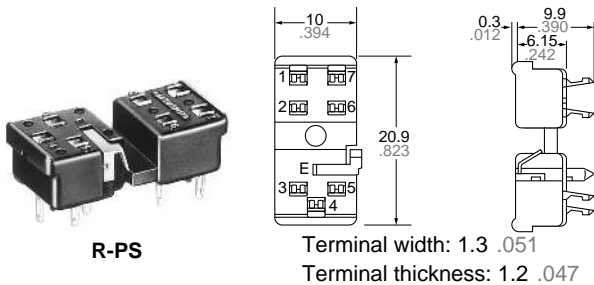

PC board pattern (Copper-side view)

