

EMI/EMC FILTER

RoHS

IS SERIES



Features

- A fuse holder and a double pole power ON/OFF switch
- Good shield effect by using metal case
- Meet over voltage category II of IEC 60664 and comply with IEC 60950
- Uses IEC connector that meets the safety standards from certification bodies
- Safety approval :
 - KC, UL, CSA, SEMKO+ENEC
 - KC, cCSAus, SEMKO+ENEC(IS-**4*H* type only)

Applications

- Digital equipments
- Measuring and testing instruments
- Communication equipment

Specifications

Model	Rated Voltage (AC, DC)	Rated Current	Leakage Current (250V AC)	Operating Temperature
IS-0242H2	250V (50/60Hz)	2A	0.35mA max.	-25°C to +85°C Including temperature rise
IS-0442H2		4A		
IS-0642H2		6A		

Note

Test Voltage : 1500V AC one minute, line to earth
 Insulation Resistance : 300 Mohm min. at 500V DC
 Voltage Drop : 1V max. at rated current
 Weight : 130g
 Inlet : Compatible with IEC-60320

Model Number Construction

I	S	02	4	2	H	0
Input Connector I : IEC Connector	Special Design S : Screw Mounting/ With Double Pole Switch and Double Fuse	Current Rating : AC rms 02 : 2amp 04 : 4amp 06 : 6amp	Line-Line Cap.Value (Input side) 1 : 0.1 μ F 2 : 0.22 μ F 4 : 0.47 μ F	Line-Gnd Cap.Value 2 : 2200 pF 3 : 3300 pF C : 330 pF D : 470 pF 0 : None	Output Terminal H : Faston Tab #250	Line-Line Cap.Value (Output side) 0 : None 2 : 0.22 μ F

Shapes and Dimensions

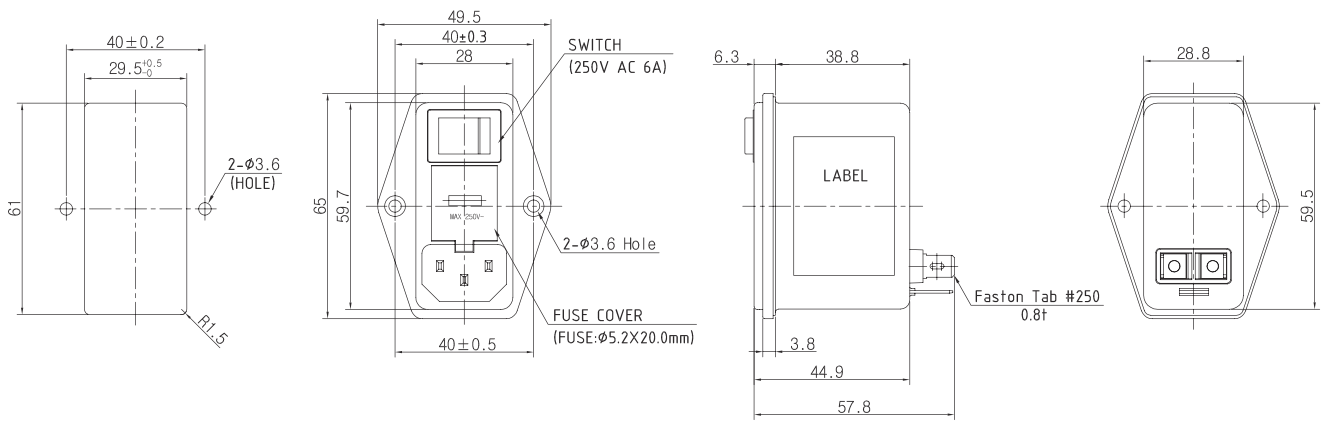

* Unit : mm
* General tolerance : ± 1.0

Attenuation Characteristics

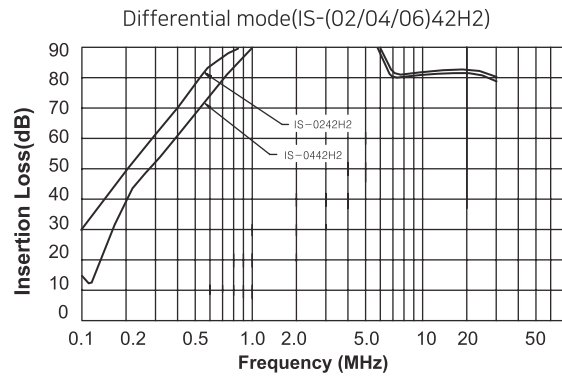
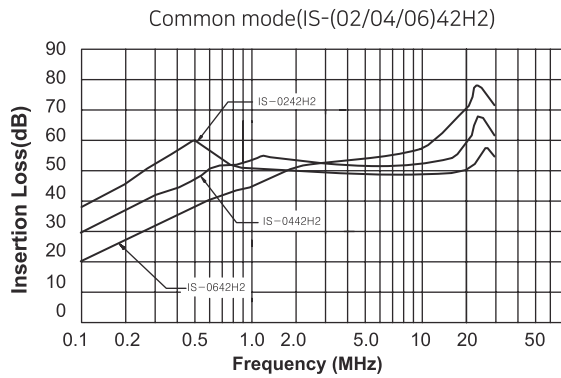

Circuit Diagram

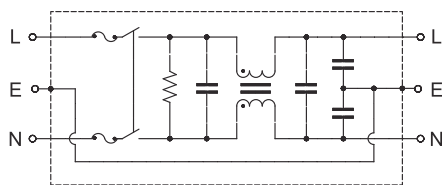

IS-***-H* type

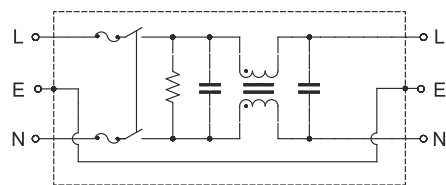

IS-***0-H* type

Measurement Configuration

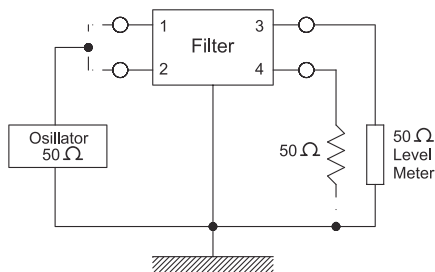

Common mode

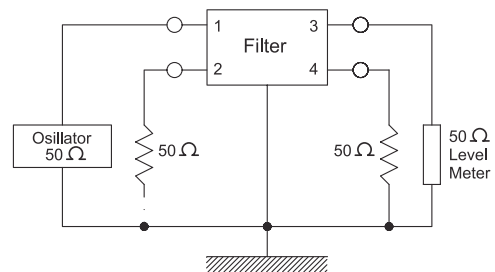

Differential mode