

TK 1111 – Polystyrene and Polycarbonate – 110 x 110 mm (4.33 x 4.33 in.)

Standard Features

- **Protection Level:** IP66 (NEMA Type: 4X and 12/12K)
- **Technical:** Smooth or Knockout Sidewalls
Gray or Tinted Transparent Cover
Multiple Enclosure Mounting Options
- **UL Recognized**
 - Enclosure Materials:** Polystyrene or Polycarbonate
 - Gasket Material:** Polyurethane
 - Color:** Light Gray
 - Material**
 - Temperature Range:** Polystyrene
-40°C to 70°C (-40°F to 158°F)
Polycarbonate
-40°C to 120°C (-40°F to 248°F)
- **Accessories:** See section below



Smooth Sidewalls

Polystyrene

Polycarbonate

Ordering Information	Height mm (in)	Cat. No.	Type	Cover Color	Std. Pk.	Cat. No.	Type	Cover Color	Std. Pk.
☐ Enclosure - low cover	66 mm (2.60 in)	110-404	PS 1111-7-o	gray	3	120-404	PC 1111-7-o	gray	3
☐ Enclosure - high cover	90 mm (3.54 in)	110-904	PS 1111-9-o	gray	3	120-904	PC 1111-9-o	gray	3
☐ Enclosure - low cover	66 mm (2.60 in)	111-004	PS 1111-7-to	trans.	3	130-004	PC 1111-7-to	trans.	3
☐ Enclosure - high cover	90 mm (3.54 in)	111-504	PS 1111-9-to	trans.	3	130-504	PC 1111-9-to	trans.	3

Sidewalls with Metric Knockouts

Polystyrene

Polycarbonate

Ordering Information	Height mm (in)	Cat. No.	Type	Cover Color	Std. Pk.	Cat. No.	Type	Cover Color	Std. Pk.
☐ Enclosure - low cover	66 mm (2.60 in)	105-404	PS 1111-7-m	gray	3	127-404	PC 1111-7-m	gray	3
☐ Enclosure - high cover	90 mm (3.54 in)	105-904	PS 1111-9-m	gray	3	127-904	PC 1111-9-m	gray	3
☐ Enclosure - low cover	66 mm (2.60 in)	106-004	PS 1111-7-tm	trans.	3	137-004	PC 1111-7-tm	trans.	3
☐ Enclosure - high cover	90 mm (3.54 in)	106-504	PS 1111-9-tm	trans.	3	137-504	PC 1111-9-tm	trans.	3

Accessories

Ordering Information	Cat. No.	Type	Std. Pk.
Mounting Plate (plastic)	195-004	TKMPI-1111	1
Mounting Plate (steel)	197-004	TKMPS-1111	1
DIN Rail TS35-81mm	198-081	TS 35/81	1
DIN Rail TS15-92mm	197-092	TS 15/92	1
Hinge Kit Set	190-002	HK1	1
Mounting Tab Kit	194-001	MT1	1

Please refer to pages 149-152 for additional accessories and detailed information.

Dimensions

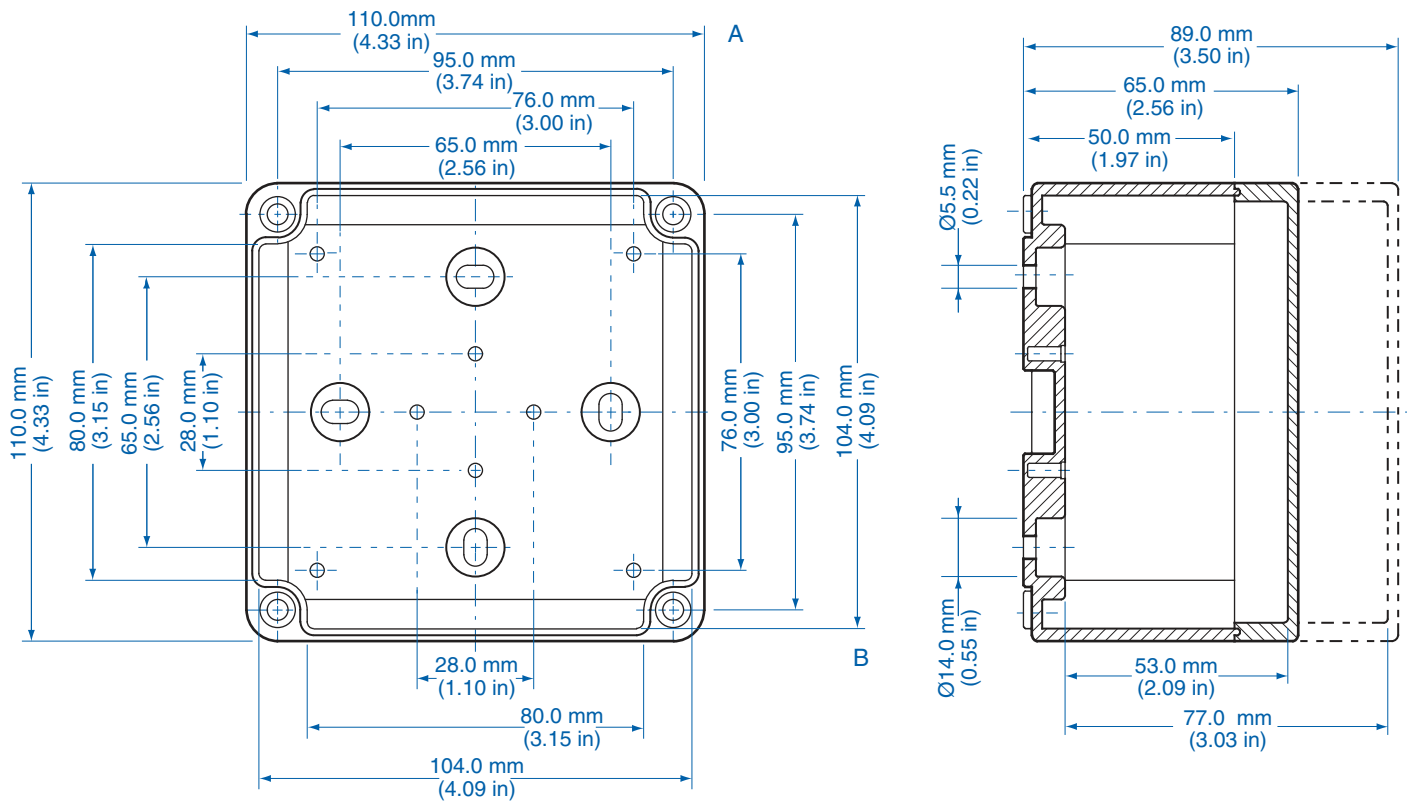

Knockout Positions

Side A

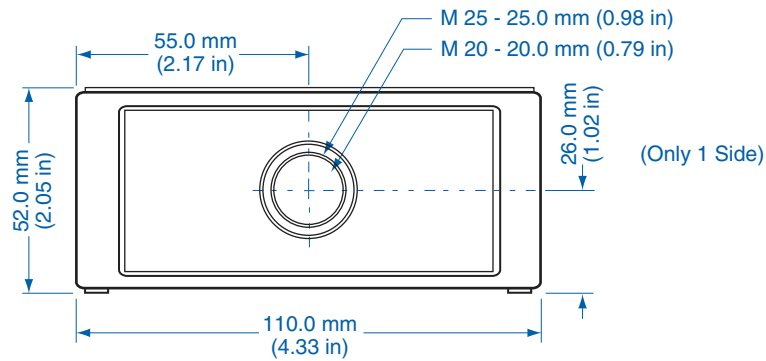

Side B

