

Technical data sheet Interconnection cable

Part no.: 50140429

KDS U-M124WM124A-T2100-003

Contents

- Technical data
- Electrical connection
- Circuit diagrams

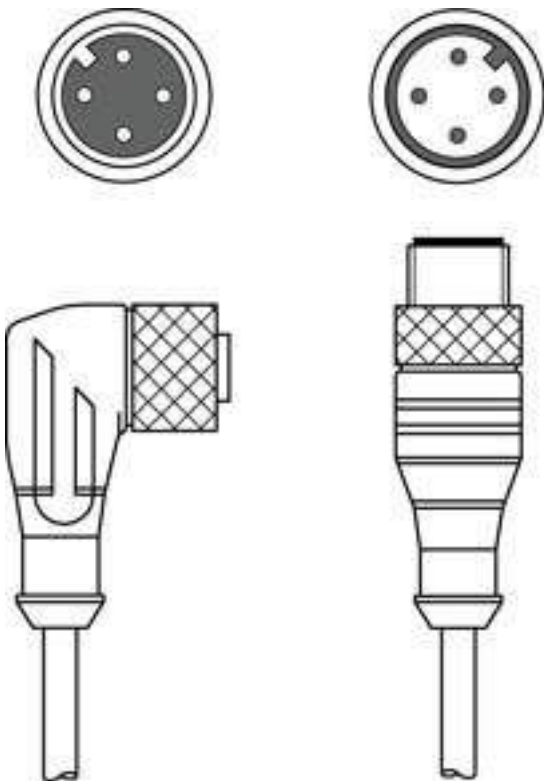

Figure can vary



Technical data

Connection

Connection 1

Type of connection	Connector
Thread size	M12
Type	Female
No. of pins	4 -pin
Encoding	A-coded
Version	Angled
Lock	Screw fitting, nickel-plated brass, recommended torque 0.5 Nm, self-locking

Connection 2

Type of connection	Connector
Thread size	M12
Type	Male
Handle body material	TPU
No. of pins	4 -pin
Encoding	A-coded
Version	Axial
Lock	Screw fitting, nickel-plated brass, recommended torque 0.5 Nm, self-locking

Cable properties

Number of conductors	4 Piece(s)
Wire cross section	0.34 mm ²
AWG	22
Sheathing color	Yellow
Shielded	No
Silicone-free	Yes
Cable design	Interconnection cable
Cable length	300 mm
Sheathing material	TPE
Wire insulation	PVC
Suitability for drag chains	Yes
Traverse rate	Max. 3.3 m/s with horiz. traverse path of 5m and and max. acceleration of 5m/s ²

Mechanical data

Width across flats	14.5 mm
Bending cycles	1,000,000 Piece(s)

Environmental data

Ambient temperature, operation, flexible use	-15 ... 90 °C
Ambient temperature, operation, stationary use	-35 ... 105 °C

Certifications

Degree of protection	IP 65
	IP 67
	NEMA 6P

Classification

Customs tariff number	85444290
eCl@ss 5.1.4	27279201
eCl@ss 8.0	27279218
eCl@ss 9.0	27060311
eCl@ss 10.0	27060311
eCl@ss 11.0	27060311
ETIM 5.0	EC001855
ETIM 6.0	EC001855
ETIM 7.0	EC001855

Electrical connection

Connection 1

Type of connection	Connector
Thread size	M12
Type	Female
No. of pins	4 -pin
Encoding	A-coded
Version	Angled
Lock	Screw fitting, nickel-plated brass, recommended torque 0.5 Nm, self-locking

Electrical connection

Connection 2

Type of connection	Connector
Thread size	M12
Type	Male
Handle body material	TPU
No. of pins	4 -pin
Encoding	A-coded
Version	Axial
Lock	Screw fitting, nickel-plated brass, recommended torque 0.5 Nm, self-locking

Circuit diagrams

Wiring schematic

